

The logo consists of a solid blue square on the left side of the page. Inside this square, the word "CORNING" is written in white, uppercase, sans-serif font, centered vertically and horizontally.

CORNING

GX 40 W Dual-Band 2.3/2.5 GHz Remote Unit

User Manual

Warranties

Hardware Warranty

Corning Optical Communications LLC (“Corning”) warrants to the original purchaser (“Customer”) that for the duration of the warranty period, one (1) year, commencing on the date of shipment of the Hardware, unless otherwise agreed in writing by Corning (the “Hardware Warranty Period”), the Hardware furnished by Corning shall be free in all material respects from defects in material and workmanship, and shall conform to the applicable portions of the Specifications, as defined below (the “Hardware Warranty”). If notified by Customer of any such defects in material or workmanship or nonconformity with applicable portions of the Specifications within the Hardware Warranty Period, Corning shall promptly, at its own election and expense, repair or replace any such Hardware proven to be defective under the terms of this Hardware Warranty. Such repair or replacement shall be Customer’s sole remedy and Corning’s sole obligation in the event this Hardware Warranty is invoked. If any components comprising a part of the Hardware are replaced or repaired during the Hardware Warranty Period, the Hardware Warranty Period for such repaired or replaced components shall extend to the longer of (i) the balance of the Hardware Warranty Period or (ii) three (3) months from the date of repair or replacement. For purposes of this Warranty, “Specifications” shall mean the specifications and performance standards of the Products as set forth in documents published by Corning and delivered to Customer which contain technical specifications or performance standards for the Products.

If Customer invokes this Hardware Warranty, it shall notify Corning promptly of the claimed defect. Customer will allow Corning to inspect the Hardware at Customer’s location, or to return the Hardware to Corning’s closest repair facility. For Hardware returned to Corning’s repair facility, Customer shall be responsible for payment of all transportation and freight costs (including insurance) to Corning’s repair facility, and Corning shall be responsible for all transportation and freight costs (including insurance) incurred in connection with the shipment of such Hardware to other repair facilities of Corning and/or its return to Customer.

Notwithstanding the foregoing, in no event will Corning be liable for damage to products resulting from improper handling during or after shipment, misuse, neglect, improper installation, operation or repair (other than by authorized Corning personnel), alteration, accident, or for any other cause not attributable to defects in materials or workmanship on the part of Corning. Corning shall not reimburse or make any allowance to Customer for any labor charges incurred by Customer for replacement or repair of any goods unless such charges are authorized in advance in writing by Corning.

Software Warranty

Corning Optical Communications LLC (“Corning”) warrants to the original purchaser (“Customer”) that for the duration of the warranty period, one (1) year, commencing on the date of shipment of the Software, unless otherwise agreed in writing by Corning (the “Software Warranty Period”), the Software shall conform with, and perform the functions set forth in the Specifications, and shall be free from defects in material or workmanship (the “Software Warranty”). In the event the Software is proven to be defective under the terms of this Software Warranty, Corning shall correct such defects or failure and ensure that the Software conforms with, and performs the functions set forth in, the Specifications. Customer will allow Corning to inspect the Software at Customer’s location or to return it to Corning’s closest repair facility.

Notwithstanding the foregoing, Corning shall have no obligation under the Software Warranty if the Software is modified or used with hardware or software not supplied or approved by Corning or if the Software is subject to abuse, improper installation or application, accident, electrical or environmental over-stress, negligence in use, storage, transportation or handling.

Third-party software distributed with the software may carry certain warranties which, to the maximum extent allowed by law, Corning hereby assigns, transfers and otherwise conveys to Customer, provided, however, that Corning itself provides no warranty of any kind, express, implied, statutory or otherwise, for any third-party software provided hereunder.

Corning does not warrant any hardware, software or services not provided by Corning.

THIS WARRANTY IS THE ONLY WARRANTY MADE BY CORNING AND IS IN LIEU OF ALL OTHER WARRANTIES, EXPRESS OR IMPLIED INCLUDING, BUT NOT LIMITED TO, THE IMPLIED WARRANTIES OF MERCHANTABILITY AND FITNESS FOR A PARTICULAR PURPOSE. CORNING SHALL NOT BE LIABLE FOR ANY OTHER DAMAGE INCLUDING, BUT NOT LIMITED TO, INDIRECT, SPECIAL OR CONSEQUENTIAL DAMAGES ARISING OUT OF OR IN CONNECTION WITH FURNISHING OF GOODS, PARTS AND SERVICE HEREUNDER, OR THE PERFORMANCE, USE OF, OR INABILITY TO USE THE GOODS, PARTS AND SERVICE. CORNING SALES AGENTS OR REPRESENTATIVES ARE NOT AUTHORIZED TO MAKE COMMITMENTS ON WARRANTY RETURNS.

Returns

In the event that it is necessary to return any product against above warranty, the following procedure shall be followed:

1. Return authorization is to be received from Corning prior to returning any unit. Advise Corning of the model, Serial number, and discrepancy. The unit may then be forwarded to Corning, transportation prepaid. Devices returned collect or without authorization may not be accepted.
2. Prior to repair, Corning will advise the customer of our test results and any charges for repairing customer-caused problems or out-of-warranty conditions etc.
3. Repaired products are warranted for the balance of the original warranty period, or at least 90 days from date of shipment.

Limitations of Liabilities

Corning's liability on any claim, of any kind, including negligence for any loss or damage arising from, connected with, or resulting from the purchase order, contract, quotation, or from the performance or breach thereof, or from the design, manufacture, sale, delivery, installation, inspection, operation or use of any equipment covered by or furnished under this contact, shall in no case exceed the purchase price of the device which gives rise to the claim.

Except as expressly provided herein, Corning makes no warranty, expressed or implied, with respect to any goods, parts and services provided in connection with this agreement including, but not limited to, the implied warranties of merchantability and fitness for a particular purpose. Corning shall not be liable for any other damage including, but not limited to, indirect, special or consequential damages arising out of or in connection with furnishing of goods, parts and service hereunder, or the performance, use of, or inability to use the goods, parts and service.

Reporting Defects

The units were inspected before shipment and found to be free of mechanical and electrical defects. Examine the units for any damage that may have been caused in transit. If damage is discovered, file a claim with the freight carrier immediately. Notify Corning as soon as possible in writing.

Note: Keep all packing material until you have completed the inspection.

Warnings and Admonishments

There may be situations, particularly for workplace environments near high-powered RF sources, where

recommended limits for safe exposure of human beings to RF could be exceeded. In such cases, restrictive measures or actions may be necessary to ensure the safe use of RF energy.

The equipment has been designed and constructed to prevent, as far as reasonably, practicable danger. Any work activity on or near equipment involving installation, operation or maintenance must be, as far as reasonably, free from danger.

Where there is a risk of damage to electrical systems involving adverse weather, extreme temperatures, wet, corrosive or dirty conditions, flammable or explosive atmospheres, the system must be suitably installed to prevent danger.

Equipment provided for the purpose of protecting individuals from electrical risk must be suitable for the purpose and properly maintained and used. This covers a range of activities including lifting, lowering, pushing, pulling, carrying, moving, holding or restraining an object, animal or person from the equipment. It also covers activities that require the use of force or effort, such as pulling a lever, or operating power tools.

Where some of the abovementioned activities are required, the equipment must be handled with care to avoid being damaged.

Observe standard precautions for handling ESD-sensitive devices. Assume that all solid-state electronic devices are ESD-sensitive. Ensure the use of a grounded wrist strap or equivalent while working with ESD-sensitive devices. Transport, store, and handle ESD-sensitive devices in static-safe environments.

Regulatory Compliance Information

WARNINGS!

- This is **NOT** a **CONSUMER** device. It is designed for installation by **FCC LICENCEES** and **QUALIFIED INSTALLERS**. You **MUST** have an **FCC LICENSE** or express consent of an FCC Licensee to operate this device. Unauthorized use may result in significant forfeiture penalties, including penalties in excess of \$100,000 for each continuing violation.
- **ANTENNAS:** Use only authorized and approved antennas, cables and/or coupling devices! The use of unapproved antennas, cables or coupling devices could cause damage and may be of violation of FCC regulations. The use of unapproved antennas, cables and/or coupling devices is illegal under FCC regulations and may subject the user to fines.

RF Safety

WARNING!

To comply with FCC RF exposure compliance requirements, each individual antenna used for this transmitter must be

installed to provide a separation distance greater than 400 cm or more from all persons during normal operation and must not be co-located with any other antenna for meeting RF exposure requirements.

- The design of the antenna installation needs to be implemented in such a way so as to ensure RF radiation safety levels and non-environmental pollution during operation.
- Antenna gain should not exceed 12.5 dBi.
- Each individual antenna used for this transmitter must be installed to provide a separation distance greater than 400 cm or more from all persons and must not be co-located with any other antenna for meeting RF exposure requirements.
- The design of the antenna installation needs to be implemented in such a way so as to ensure RF radiation safety levels and non-environmental pollution during operation.

Compliance with RF safety requirements:

- Corning products have no inherent significant RF radiation.
- The RF level on the downlink is very low at the downlink ports. Therefore, there is no dangerous RF radiation when the antenna is not connected.

Laser Safety

Fiber optic ports of the GX system emit invisible laser radiation at the 1310/1550 nm wavelength window.

The laser apertures/outputs are the green SC APC bulkhead adapters located on the front panel of the equipment.

The product is Class 1/Hazard level 1.

External optical power is less than 10 mW, Internal optical power is less than 500 mW.

To avoid eye injury, never look directly into the optical ports, patch cords, or optical cables. Do not stare into beam or view directly with optical instruments. Always assume that optical outputs are on.

Only technicians familiar with fiber optic safety practices and procedures should perform optical fiber connections and disconnections of GX devices and the associated cables.

GX has been tested and certified as a “Class 1” Laser product to IEC/EN 60825-1(2007). It also meets the requirements for a Hazard Level 1 laser product to IEC/EN 60825-2: 2004 to the same degree.

GX complies with 21 CFR 1040.10 and 1040.11 except for deviations pursuant to Laser Notice No. 50 (2007).

The product itself has been tested and certified as a Class 1 Laser product to IEC/EN 60825-1 (2007). It also meets the requirements for a Hazard Level 1 laser product to IEC/EN 60825-2: 2004 to the same degree.

Care of Fiber Optic Connectors

Do not remove the protective covers on the fiber optic connectors until a connection is ready to be made. Do not leave connectors uncovered when not connected.

The tip of the fiber optic connector should not come into contact with any object or dust.

Standards and Certifications

Corning products have met the approvals of the following certifying organizations:

Category	Standards
Safety:	CB: IEC 60950-1; NRTL: UL 60950-1; CAN/CSA: C22.2 NO 60950
EMC:	FCC: Part 15 subpart B
Radio:	FCC: Part 27
ISO:	ISO 9001: 2000 and ISO 13485: 2003

Licensee Contact Information

Industrial Boosters may only be used by FCC licensees or those given express (individualized) consent of license. Corning certifies all of the VARs listed as licensed installers for Corning. For the list of licensed VARs, please contact the Corning Tech Support Hotline: (US) 410-553-2086 or 800-787-1266.

About This Manual

This user manual describes how to perform the physical installation and interface connections of the GX dual-band remote unit. The scope of the user manual includes the interface box (IFB) required for deployments with the Corning® optical network evolution (ONE™) solution. The installation procedures of other units (e.g., HEU/IHU, IFB, RIU, OCH, SC-450) relevant to the system are detailed in their user manuals (see Additional Relevant Documentation).

Additional Relevant Documents

The following documents are required if the corresponding units are included in your system. These can be downloaded from the Corning portal.

Document Name	Part Number
RIU Product Family (RIU-4, RIU-IM, and RIU-Lite) User Manual	709C007703 Rev. A00/CMA-139-AEN
RIU-12 User Manual	709C011602 Rev. A00/CMA-334-AEN
FT350 Installation Guide (includes OCH information)	CMA-208-AEN
System Controller User Manual (SC-450 v7.4 and higher)	CMA-456-AEN
IFB Quick Installation Sheet	—
Corning® Optical Network Evolution (ONE™) Solutions System Installation User Manual (includes HEU/IHU information)	CMA-490-AEN

List of Acronyms

Term	Meaning
BTS	Base transceiver station
BTSC	Base transceiver station conditioner
DL	Downlink
GX	Greater-power unit
HEU	Headend unit
IFB	Interface box
IHU	Integrated headend unit
OCH	Optical central hub
RIU	Radio interface unit
UL	Uplink

TABLE OF CONTENTS

1 Introduction

1.1	Key Features and Capabilities.....	7
1.2	System Description.....	8
1.2.1	GX Dual-Band with Corning® Optical Network Evolution (ONE™) Solution.....	8
1.2.2	GX Interface Box (IFB) to ONE Headend.....	10
1.2.3	GX Deployed with MA1K/MA2K Platform.....	10
1.3	System Monitoring and Management.....	12
1.4	GX Dual-Band Interfaces.....	13
1.5	IFB Interfaces.....	15

2 Installation Guidelines

2.1	Site Considerations.....	17
2.1.1	Installation Location.....	17
2.1.2	Environmental.....	17
2.1.3	Powering.....	17
2.1.4	Grounding Requirement.....	17
2.1.5	Cable Routing.....	17
2.1.6	Manual Handling.....	17
2.2	Installation Requirements.....	17
2.3	Fiber Optic Rules.....	18

3 System Installation

3.1	Selecting GX Dual-Band Mounting Location.....	19
3.2	Unpacking and Inspection.....	19
3.3	Additional Required Tools.....	21
3.4	Required Headend Connections for Deployments with Corning® Optical Network Evolution (ONE™) Solution.....	21
3.4.1	HEU/IHU-to-IFB Connections.....	21
3.4.2	IFB-to-OCH Connections.....	22
3.4.3	Management Connections.....	22
3.5	Outdoor Concrete Wall-Mountable Installation.....	23
3.6	Additional Installation Options.....	23
3.6.1	Indoor Wall-Mountable Installation.....	23

3.6.2	Wooden Pole-Mountable Installation.....	25
3.7	GX Connections.....	29
3.7.1	Grounding Connections.....	29
3.7.2	Fiber Connections.....	29
3.7.3	RF Connections.....	31
3.7.4	Power Connections.....	32
3.7.4.1	AC Models.....	32
3.7.4.2	DC Models.....	32
3.7.5	External Alarm Connections.....	33
3.7.6	System Alarm Pin-Out Description.....	34
3.8	Verifying Normal Operation.....	34

4 Appendices

4.1	Appendix A: System Specifications.....	35
4.2	Appendix B: Ordering Information.....	38

1 INTRODUCTION

GX products offer scalable, cost-effective 40 W (46 dBm) high-power remote outdoor coverage solutions for Corning distributed antenna systems (DAS).

GX remotes compliment both the MA1000/MA2000 platform and the Corning® optical network evolution (ONE™) solution, sharing a common equipment headend and element management system (EMS) with the other system remotes.

GX is a fiber-fed, dual-band, multioperator remote designed to complement lower power, standard remotes. GX can also be installed as a dedicated solution for new sites, providing complete RF coverage in large open indoor, tunnel, and adjacent outdoor spaces.

Using low-loss fiber optic cabling, GX remote units can distribute multiple BTS signal sources for 2.3 GHz and 2.5 GHz TDD to multiple remote locations between 2 to 15 km from the headend to remotes. GX efficiently supports all operator modulations with linear MCPA (multicarrier power amplifier) up to 40 W.

GX remotes offer high RF power coverage capabilities with compact design for added spaces savings and weather-resistant enclosures to fit various site needs..

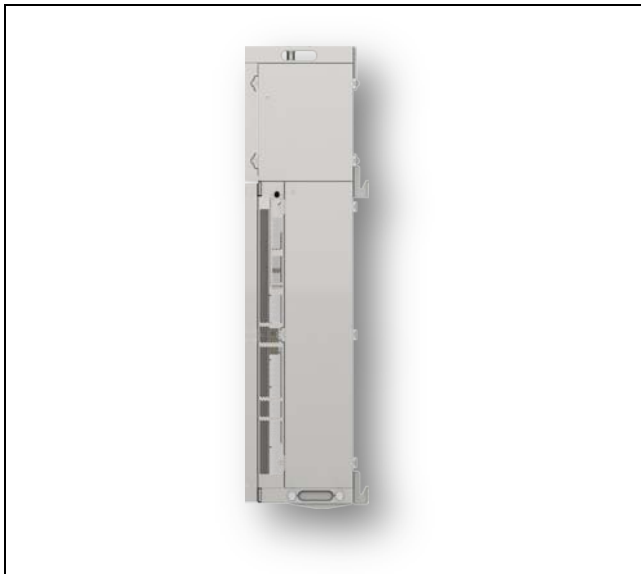

GX Dual-Band Remote | Figure 1.1

1.1 Key Features and Capabilities

Multi-frequency/multiservice RF transport platform:

- Accommodates LTE technology
- Two bands per enclosure

Cost-effective high power

Optimizes and reduces the number of antennas required to cover open outdoor areas by offering 46 dBm composite power per frequency band

Operator-grade operation

Advanced signal handling, RF filtering, and management ensures operator-grade performance

SISO/MIMO support

Model dependent units supporting either SISO or MIMO configurations

Unique, space-saving, non-obtrusive design

Blends into the environment and avoids costly tower builds outdoors when covering campus scenarios, parking lots, tunnels, and indoor-adjacent outdoor spaces

Designed to withstand harsh environments

Fully sealed remote unit (RU) enclosure ensures superior performance in harsh environments and worry-free electronics maintenance. Compliant to NEBS OSP Class 4 rated standard

Management and control

Alarm forward to NOC or standard EMS via SNMP, software-controlled output power, and optical link auto gain control

1.2 System Description

1.2.1 GX Dual-Band with Corning® Optical Network Evolution (ONE™) Solution

Figure 1.2 illustrates a scenario including the dual-band GX MIMO remote supporting the WCS and 2.5 GHz TDD bands and two quad-band GX remote units each supporting ESMR/CELL, PCS, 700 LTE, and EAWS deployed with the Corning® optical network evolution (ONE™) solution.

The MIMO1 and MIMO2 RF signals, received from the BTS, are conditioned by the headend unit (HEU), ensuring a constant RF level. The conditioned MIMO1 and MIMO2 signals are then transferred via the interface box* (IFB) and routed through the optical central hub (OCH)† optical modules. For the TDD band, an integrated IF clock module (pilot), installed in the IFB enables transmitting the converged wideband RF/IF and pilot signals through the interface box to the OCH. The OCH converts the RF signal to an optical signal for transport over low-loss fiber cabling to/from multiple GX remotes, where they are converted to high-level RF signals. The GX includes an internal combiner so that both WCS and 2.5 GHz TDD bands services are transmitted via a single output port (SISO) or two for MIMO. An external low-loss combiner is used to combine the dual-band GX with the quad-band GX to support six bands services on a single output port.

The GX remotes (and OCH) are managed and controlled via the headend control module (HCM)‡ installed in the headend chassis, enabling local and remote management and providing single-source, centralized common headend controls of all installed elements.

**Each interface box supports connections to up to two HEUs or integrated headend units (IHUs) via ERFCv2 cables.*

†RF connections between the interface box and the OCH are performed using QMA-to-QMA cables (accessory kit part number: AK-RIU4-OCH-CABLES).

‡In deployments with the ONE solution, GX remotes require an SC-450 interfacing between the OCH and HCM for management capabilities.

Notes:

- Only extended radio interface modules (RIME) support GX-E17E85P19L70-40-AC and GX-E17E85P19L70-40-DC. See ordering information in this document for relevant part numbers.
- The dual-band GX with WCS and 2.5 GHz TDD support is supported by SC-450 v7.6 and higher and ONE v3.3 and higher.

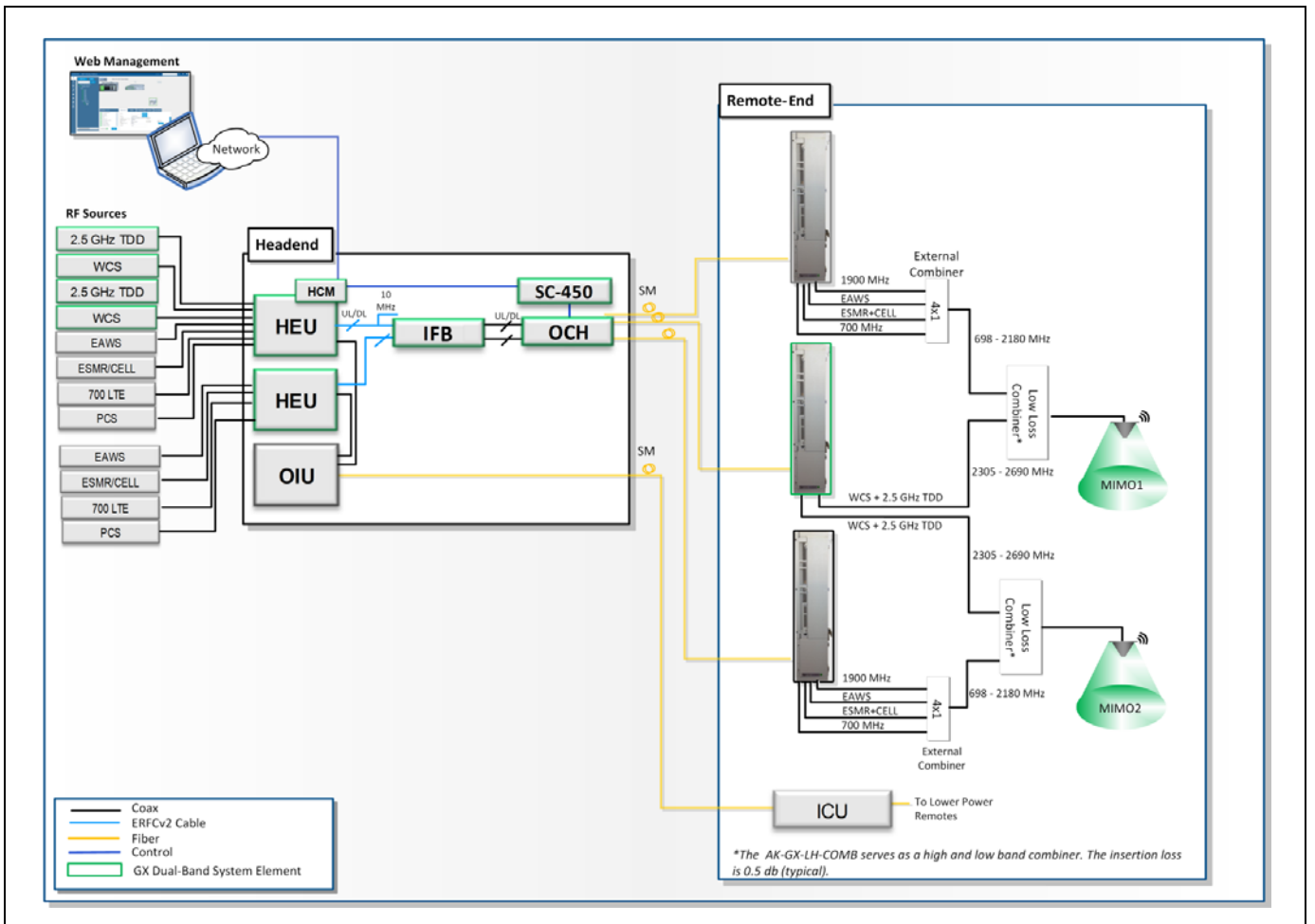

Example of GX Dual-Band with Quad-Band Remotes in Corning® Optical Network Evolution (ONE™) Deployment | Figure 1.2

1.2.2 GX Interface Box (IFB) to ONE Headend

The IFB is a combiner/splitter interface box which supports connections to two HEUs, combines the RF services and routes them through optical central hub (OCH) modules towards the GX remotes.

The IFB includes an integrated intermediate frequency (IF) clock module for generating a 2970 MHz pilot signal required for synchronizing the TDD band.

The IFB enables deploying a GX high-power WCS/2.5 GHz TDD (dual-band) remote alongside a GX quad-band remote where it supports connections to two OCH optical modules per service group (i.e., three OCH-8 or six OCH-4 units).

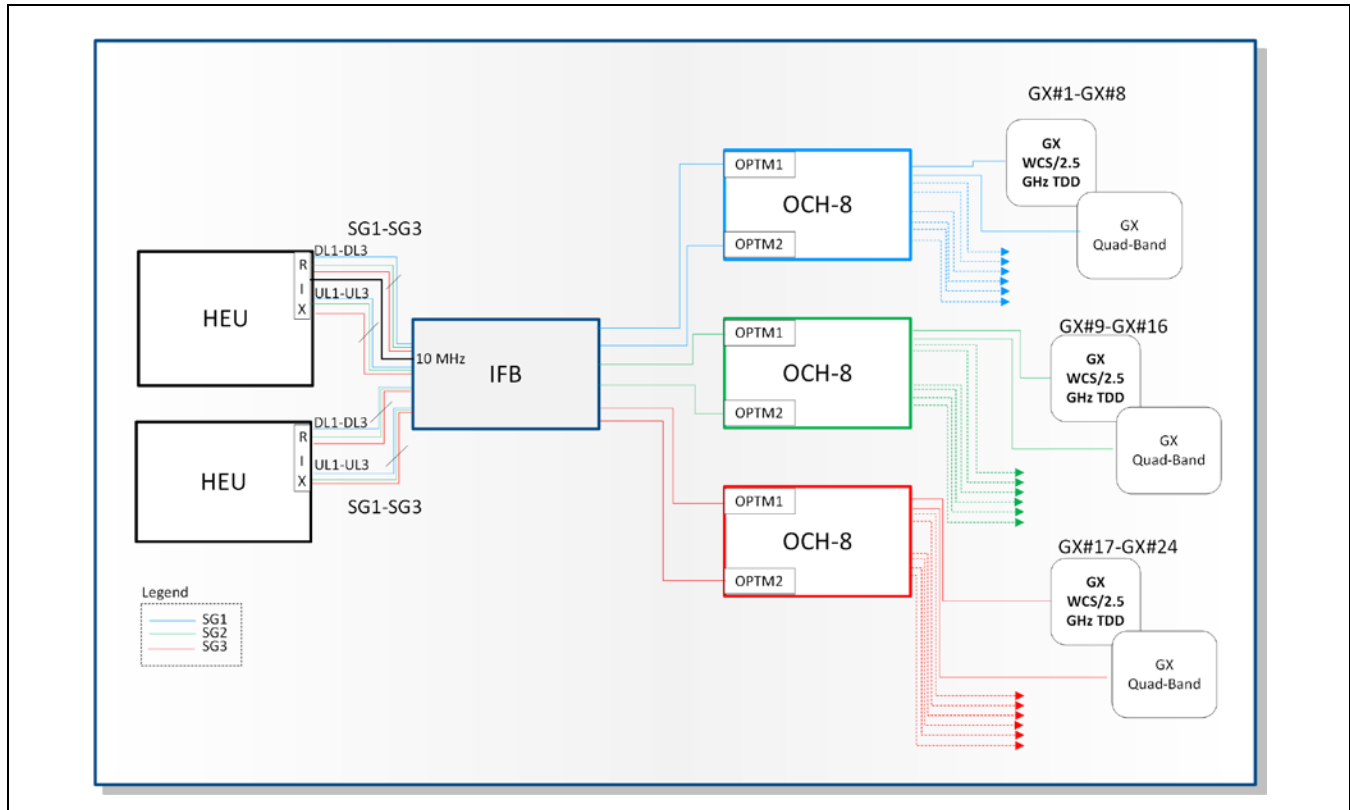

Block Diagram of IFB System Description | Figure 1.3

1.2.3 GX Deployed with MA1K/MA2K Platform

Figure 1.4 illustrates a GX dual-band remote MIMO scenario deployed with an MA1000/2000 headend alongside two GX quad-band remotes providing MIMO coverage for the CELL/ESMR, PCS, EAWS, and 700 LTE bands..

Note: GX quad-band models GX-E17E85P19L70-40-AC and GX-E17E85P19L70-40-DC do not support coexistence with other GX models. The quad-band services must be routed through separate RF paths (i.e., different RIU-12 sector and optical module).

The MIMO1 and MIMO2 services are conditioned via two independent sectors in the RIU-12 units, ensuring a constant RF level for each MIMO stream. The conditioned MIMO1 and MIMO2 signals are routed through separate optical modules in the OCH. Each optical module converts the RF signal to an optical signal for transport over low-loss fiber cabling to/from connected GX remote, where they are converted to high-level RF signals.

The GX dual-band remote includes an internal combiner so that both WCS and 2.5 GHz TDD bands services are transmitted via a single output port (SISO) or two for MIMO. In addition, an external low-loss combiner is used to combine the dual-band GX with the quad-band GX to support six bands services on a single output port.

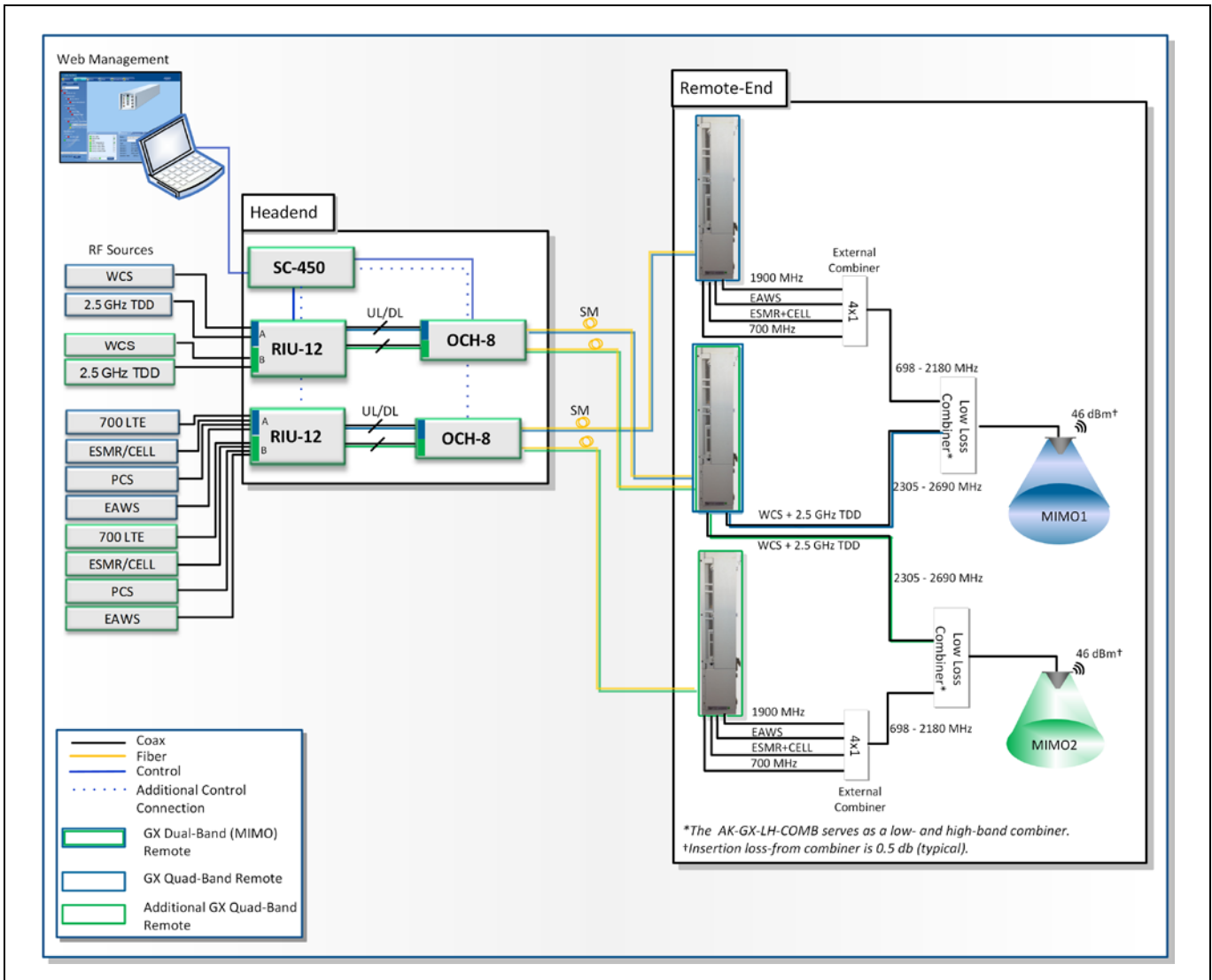

Example of GX Dual-Band alongside GX Quad-Band Remotes in an MA2K System Deployment | Figure 1.4

1.3 System Monitoring and Management

The GX dual-band remote unit is centrally managed via the SC-450 (v7.5 and higher) in MA1K/MA2K solutions and via the headend control module (HCM v3.2 and higher) when deployed with Corning® optical network evolution (ONE™) solutions*.

**In Corning optical network evolution (ONE) solution deployments, the SC-450 is also required for the GX management.*

The GX remote management connection is performed via the optical central hub (OCH) to which it is physically connected. The OCH is connected directly to the SC-450 controller so that a single management connection enables management and monitoring capabilities for the GX and host OCH.

Figure 1.5 and Figure 1.6 show examples of GX management screens in the SC-450 and HCM management web GUI applications.



Example of GX Dual-Band SC-450 Configuration Tab | Figure 1.5



Example of GX Dual-Band HCM Device Configuration Tab | Figure 1.6

1.4 GX Dual-Band Interfaces

All of the GX interfaces (except for the power connector) are located externally on the underside of the unit (facing down when unit is mounted). The unit interfaces include the RF, ground, optical link, and external alarms connections. The power connector (AC/DC) is located on the side panel. See Figure 1.7.

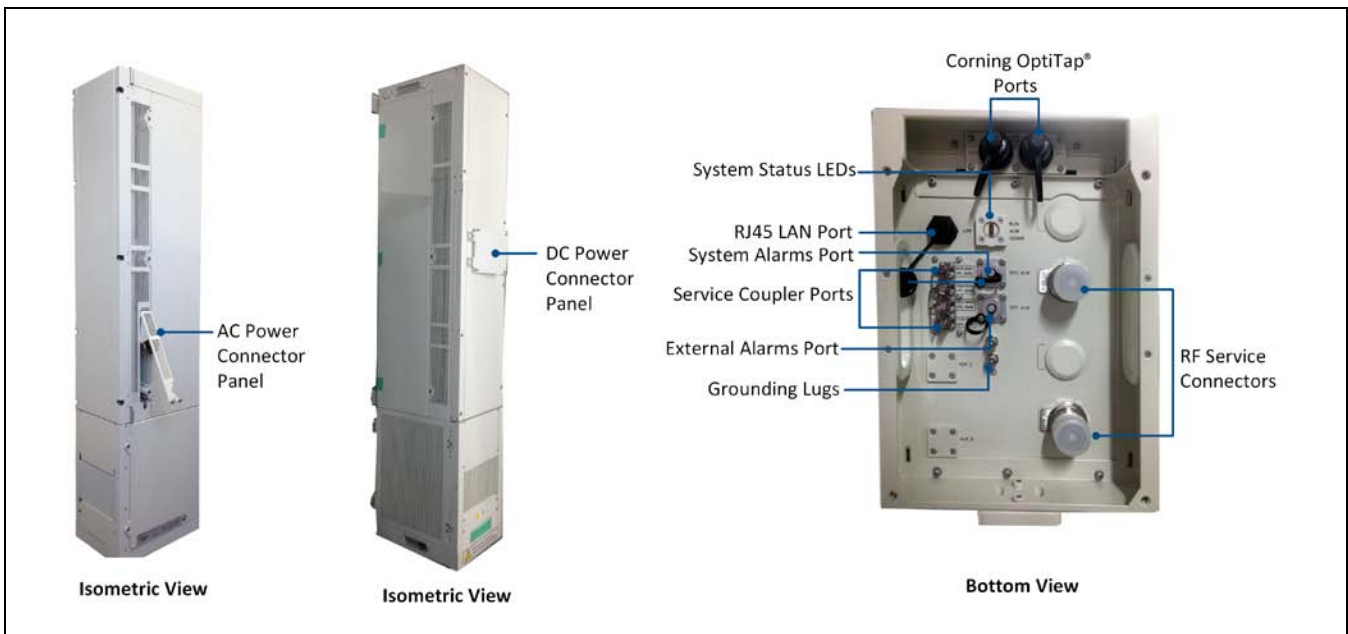

Example of GX Dual-Band Remote Interfaces | Figure 1.7

Table 1.1 and Table 2.2 provide descriptions of the GX dual-band interfaces and LEDs.

Interface	Description
Service Connectors	<p>Duplexed RF DIN female output connector to antennas (or external combiner); Both 2.3 GHz (WCS) and 2.5 GHz service bands are distributed through a single antenna output port</p> <p>One connector for SISO models</p> <p>Two connectors for MIMO models</p>
OP	<p>Corning OptiTap® fiber optic waterproof connector – connects to OCH using Corning OptiTap to SC APC cable (ordered separately). One connector for SISO models and two for MIMO.</p> <p>IMPORTANT! OptiTap pull-out force ranges from a few lbs to 50+ lbs with the dust cap or connector installed. This prevents damages caused to the DAS unit.</p>
Power Connector (side panel)	<p>Power feed option is model dependent (AC/DC). Refer to Appendix A for detailed power specifications</p> <p><i>Note: AC models include power cable. Only provided power cable is to be used for power connection.</i></p>
Grounding Lugs	<p>Two grounding screws — accessed from side panel; double lugs with 6 gauge wire</p>
LAN	<p>RJ45 connector for local connection (i.e., debugging, troubleshooting)</p>
EXT_ALM	<p>External Alarm pin-out connectors supporting four external alarm connections</p>
SYS_ALM	<p>Pin-out connector supporting up to three relay alarms used for connecting the GX dual-band to a network or modem and relaying the status of the GX alarms</p>
WCS SISO CPL -50 dB	<p>Coupler port WCS SISO 50 dB coupling</p>
TD25 SISO CPL -50 dB	<p>Coupler port 2.5 GHz TDD SISO 50 dB coupling</p>
WCS MIMO CPL -50 dB (for MIMO model)	<p>Coupler port WCS MIMO 50 dB coupling</p>
TD25 MIMO CPL -50 dB (for MIMO model)	<p>Coupler port 2.5 GHz TDD MIMO 50 dB coupling</p>

GX Dual-Band Interface Descriptions | Table 1.1

LED	Status	Description
RUN	Blinking green	Normal status, power on
	Off	Alarm status
ALM	Steady red	General alarm
	Blinking red (two second blinking)	Synchronization alarm
	Blinking red (one second blinking)	Optical attenuation alarm
	Off	Normal status
COMM.	Blinking green — blinks on each command received by the GX	Normal communication
	Off	Communication fault

GX Dual-Band LED Description | Table 1.2

1.5 IFB Interfaces

The IFB is a combiner/splitter interface box which supports connections to two HEUs, combines the RF services, and routes them through optical central hub (OCH) modules (two per

service group) towards the GX remotes. All interfaces are on the front panel.

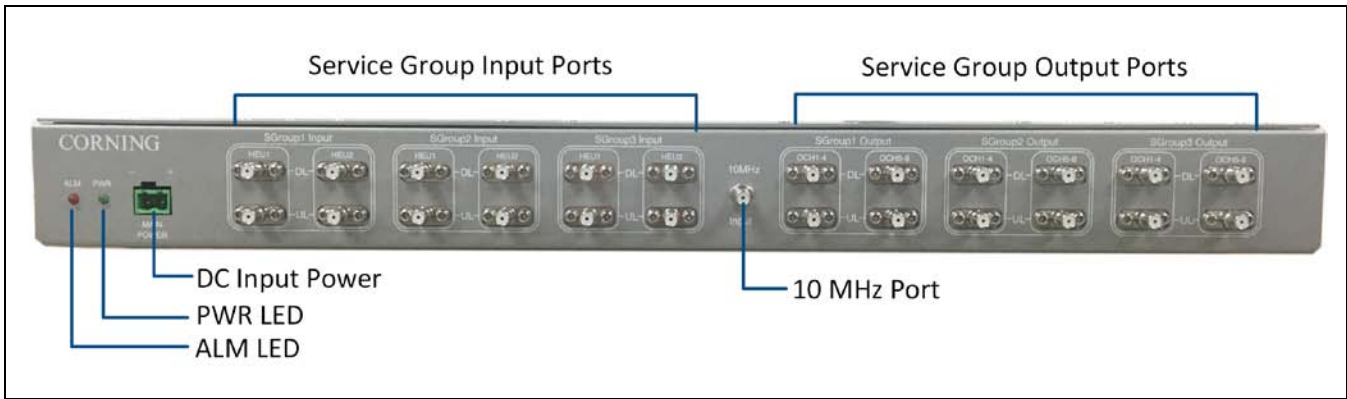

IFB Interfaces | Figure 1.8

Interface	Description
SGroup Input 1/2/3	12 QMA input ports (six UL and six DL) — used for IFB connections to two HEUs; HEU1 and HEU2 input connections for three service groups
SGroup Output 1/2/3	12 QMA output ports (six UL and six DL) — used for IFB connections to OCHs; connections to two OCH optical modules per service group
10 MHz Input	One QMA input port — 10 MHz reference signal
Main Power	DC input — two pin plug; power input — -40 to -48 VDC

Interface	Description
ALM (LED)	Red — fault detected with TDD sync (unlocked)
PWR (LED)	Green — input power OK

IFB Interface Descriptions | Table 1.3

2 INSTALLATION GUIDELINES

This chapter provides the general guidelines for installing the GX dual-band remote and includes information such as site considerations and installation requirements.

2.1 Site Considerations

- The distance between the GX service antenna and the coverage area should correspond to line of sight (LOS) requirements for maximum coverage area.
- The maximum fiber path loss is 6 dB.
- The system delay of the optical system must be taken into consideration when there are neighboring BTS sites overlapping in coverage.
- In the MIMO scenario, one MIMO remote unit shall use two pairs of optic fiber to ensure avoiding system delay.

2.1.1 Installation Location

Mounting surface shall be capable of supporting the weight of the equipment.

In order to avoid electromagnetic interference, a proper mounting location must be selected to minimize interference from electromagnetic sources such as large electrical equipment.

2.1.2 Environmental

Humidity has an adverse effect on the reliability of the equipment. It is recommended to install the equipment in locations having stable temperature and unrestricted airflow.

The installation location for the system should be well ventilated. The equipment has been designed to operate at the temperature range and humidity level as stated in the product specifications at temperatures ranging from -40~70 degrees Celsius and a relative humidity of maximum 95 percent.

2.1.3 Powering

- The power supply unit provides power to all modules within the equipment. Depending on the product variant, it is recommended that the PSU operates on a dedicated AC circuit breaker or fused circuit.
- Pluggable equipment — the socket outlet should be installed near the equipment and be accessible

2.1.4 Grounding Requirement

Verify that the equipment has been well grounded. This includes GX dual-band unit, external combiner, antennas, and all cables connected to the system. For GX grounding, use provided copper wire grounding cable. Ensure lightning protection for the antennas is properly grounded.

2.1.5 Cable Routing

Ensure all cables, e.g., power cable, feeder cable, optic fiber, commissioning cable, connecting are properly routed (use drip loops) and secured so that they are not damaged.

2.1.6 Manual Handling

During transportation and installation, take necessary handling precautions to avoid potential physical injury to the installation personnel and the equipment.

2.2 Installation Requirements

- Working space available for installation and maintenance for each mounting arrangement. Ensure unrestricted airflow.
- Ensure grounding connector is within reach of the ground wire.
- Ensure a power source is within reach of the power cord and the power source has sufficient capacity.
- Where appropriate, ensure unused RF connectors are terminated.

- Do not locate the equipment near large transformers or motors that may cause electromagnetic interference.
- Reduce signal loss in feeder cable by minimizing the length and number of RF connections.
- Ensure the equipment will be operated within the stated environment (refer to datasheet).
- Where appropriate, confirm availability of suitably terminated grade of RF and optical fiber.
- Observe handling of all cables to prevent damage.
- Wavelength division multiplexing (WDM) units require single-mode fiber.
- Use minimum splicing/connectors to achieve minimum losses on the fibers.
- Use precaution while installing, bending, or connecting fiber optic cables.
- Use an optical power meter and optical time domain reflectometer (OTDR) for checking the fiber optic cables.
- Make sure the environment is clean while connecting/splicing fiber optic cables.

2.3 Fiber Optic Rules

ATTENTION!

- Please also refer to the laser safety section in the document preface material.
- Fiber optic cables require proper handling. Do not stretch, puncture, or crush the fiber cable(s) with staples, heavy equipment, doors, etc.
- Always maintain the minimum bend-radius specified by the cable manufacturer. The minimum bend radius is usually ten times the cable's outer diameter. In the case of single optical fiber that is not in a cable, the minimum bending radius to be observed is 30 mm.
- All fiber optic connections should be cleaned prior to attaching to termination points using a dry cleaning device (e.g., Cletop or equivalent).
- Fiber connector protective caps should be installed on all non-terminated fibers and removed just before they are terminated.
- Check the fiber optic connections.

3 SYSTEM INSTALLATION

This chapter describes the installation procedure for the GX dual-band remote unit.

3.1 Selecting GX Dual-Band Mounting Location

Select the mounting location (wall/pole):

- General surroundings
- Ventilated and easy-to-reach area
- Proximity to the antenna in order to minimize cable loss







For installations with GX external multiplexer — take into

consideration that the unit must be mounted adjacent to the GX RF interfaces to facilitate the connections (DIN-DIN cables = 1.2 m).



3.2 Unpacking and Inspection

Unpack and inspect the cartons as follows:





1. Open the shipping carton and carefully unpack each unit from the protective packing material.
2. Please verify that the items listed in Table 3.1 are included in your package (image size is not proportional) and check for signs of external damage. If there is any damage, call your Corning service representative.

Item	Quantity	
GX Dual-Band Remote Unit	1	
Mounting Bracket (used for both pole and wall installations)	1	
M8 Nuts, Spring Washers 8 mm diameter, Plain Washers 8 mm diameter – used for securing remote unit when hung on bracket protrusions	2 (per item)	
Masonry Bolt (set) M10x110 – used for wall-mountable installations	6	
Power Supply Cable (AC) – for AC models	1	
Power Cable Tube Gasket (DC) – for DC models	2	

GX Dual-Band Package Items | Table 3.1

Item	Quantity	
Copper Grounding Wire (2 m)	1	
RJ45 Ethernet Communication Cable	1	

GX Dual-Band Package Items | Table 3.1 (continued)

Additional items required (and ordered separately) for installations with Corning® Optical Network Evolution (ONE™) Solution	Quantity	
ERFCv2-OCH – RF Cables used for interfacing between headend (i.e., HEU/IHU) extender module and the interface box (IFB)	1	
AK-ONE-HE-GX-INTBOX – Combiner/Splitter used for interface between the headend unit and the OCH	1	
OCH-4-WDM (top) – 4-Port Optical Central Hub supporting up to four SISO remotes; wavelength division multiplexing technology; single-mode fiber OCH-8-WDM (bottom) – 8-Port Optical Central Hub supporting up to eight SISO remotes or four MIMO remotes; wavelength division multiplexing technology; single-mode fiber	1	
SC-450 – System Controller used for management of GX and OCH	1	

Required Items for GX Dual-Band in Installations with Corning® Optical Network Evolution (ONE™) Solution | Table 3.2

Additional items required (and ordered separately) for installations with MA1000/MA2000 deployment including RIU	Quantity	
AK-RIU4-OCH-CABLES – RIU-4 Cable Accessory Kit required for RIU-4-to-OCH connections, four QMA-to-QMA R/A cables; Length = 1 m	1	-
AK-RIU12-OCH-CABLES – RIU-12 Cable Accessory Kit including four RF QMA/QMA R/A cables used for connections between RIU-12 and OCHs; Length = 1 m	1	-

Required Items for GX Dual-Band in Installations with MA1K/MA2K | Table 3.3

3.3 Additional Required Tools

- Electric drill (12 mm diameter head for drilling holes for wall mount)
- Spanner (0.31-in for tightening GX M8 nuts)
- For pole-mountable installations – the GX bracket supports wooden pole mounting via a dedicated GX accessory kit (ordered separately): AK-GX-QUAD-BRKT-WDPOLE

3.4 Required Headend Connections for Deployments with Corning® Optical Network Evolution (ONE™) Solution

Important!

Each headend unit (HEU) supports up to eight GX remotes.

The following additional elements are required (ordered separately):

- Interface box — AK-ONE-HE-GX-INTBOX; used to combine the RF services from two HEUs/IHUs and required for synchronizing the TDD band (includes IF clock module for generating a 2970 MHz pilot signal)
- Optical central hub — OCH-4-WDM or OCH-8-WDM; installed in 19-in communication rack with HEU
- ERFCv2-OCH cable
- SC-450 — installed in 19-in communication rack with the HEU and OCH

Notes:

- Refer to the quick installation sheets provided with the HEU, IFB, OCH, and SC-450 for instructions on how to install the units.
- Refer to Figure 3.6 for an example of where to install the IFB, OCH, and SC-450 units in the communication rack with the HEU in order to facilitate the cable connections.

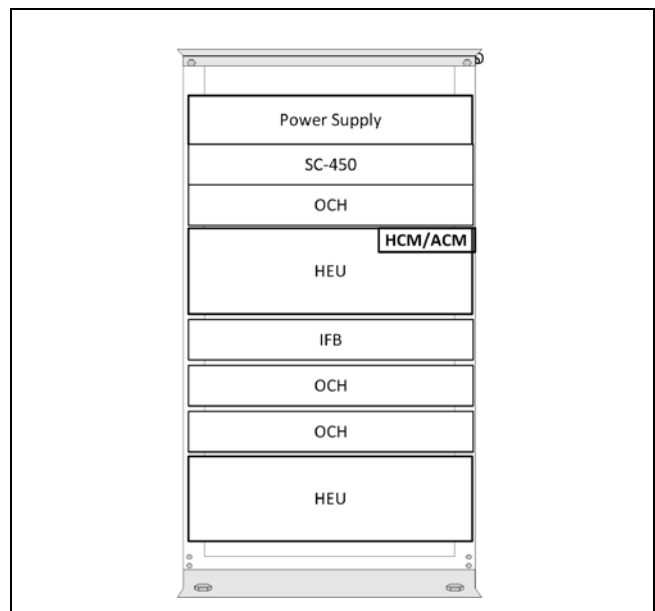

Example of Rack Configuration with HEU | Figure 3.1

3.4.1 HEU/IHU-to-IFB Connections

Refer to Figure 3.2 and connect the HEU(s) to the IFB using the ERFCv2-OCH cable as follows:

Note: Each ERFCv2-OCH cable supports UL/DL connections to up to three service group input connections and one 10 MHz reference clock connection.

1. Connect the 9-pin connector side of the ERFCv2-OCH cable to an available HEU/IHU RIX port and secure the connector in place.
2. UL/DL QMA connections — connect a pair of UL/DL QMA cables to each of the IFB UL/DL service group input ports (i.e., SG1, SG2, and SG3).
3. Connect the single QMA connection cable to the IFB 10 MHz QMA port.
4. Perform Steps 1-2 above for second HEU if installed.

Note: Only one 10 MHz clock reference connection to the IFB is required.

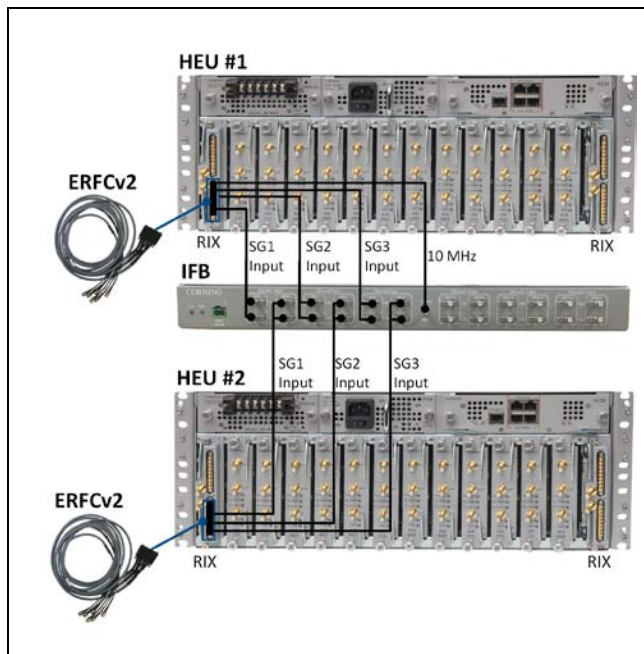

Example of Connections between IFB and Two HEUs via ERFCv2 Cables | Figure 3.2

3.4.2 IFB-to-OCH Connections

The IFB output connections to the OCH are performed using QMA/QMA cables (not provided with unit). Corning accessory kits including appropriate cables can be ordered separately (see Table 3.3).

Each IFB supports two optical modules (i.e., one OCH-8 or two OCH-4 units) per service group.

Refer to Figure 3.3 and connect the IFB to the OCH as follows:

UL/DL QMA connections — connect a pair of QMA/QMA cables from each of the service group UL and DL output ports to the

OCH optical module UL and DL link ports. IFB supports connections to two optical modules per service group.

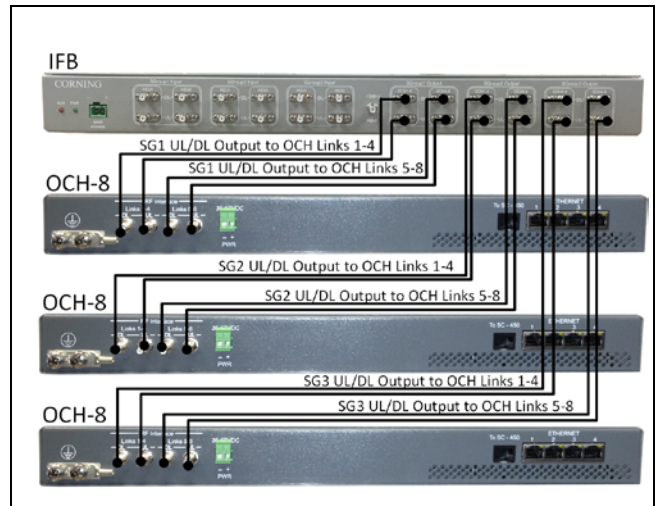

Connections Between IFB and Three OCH-8 Units | Figure 3.3

3.4.3 Management Connections

Connect the SC-450 front panel “LAN” port to any one of the control module’s (HCM/ACM) four “INTERNAL” ports using the RJ45 CAT 5 Ethernet cable, as shown in Figure 3.4.

GX management capabilities are attained through the OCH connections to the SC-450 controller.

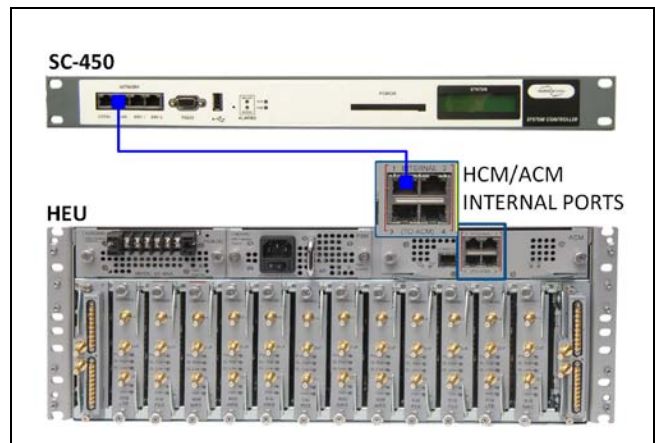

HCM-to-SC-450 Management Connection | Figure 3.4

3.5 Outdoor Concrete Wall-Mountable Installation

Note: The instructions provided in this section are for solid brick and concrete walls only.

- Using the mounting bracket top and bottom mounting holes as a guide (see Figure 3.5), measure and mark the location for drilling the (supplied) M10 masonry bolts (12 mm dia) in the wall (six per bracket).
- Drill holes for the masonry bolts (using an electric drill with a 12 mm diameter head).
- Using six M10x110 masonry bolts per bracket – secure the mounting brackets to the wall with the protruding M8 nuts facing toward you. See Figure 3.5.

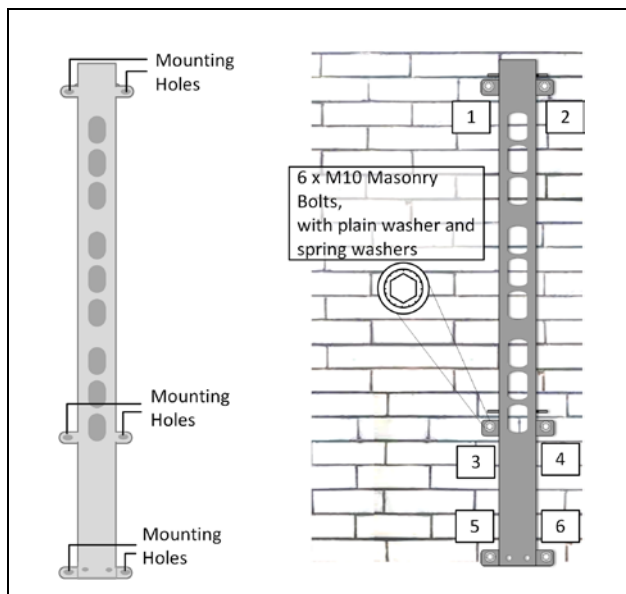

GX Bracket Wall-Mountable Option | Figure 3.5

3.6 Additional Installation Options

Additional mounting options are provided with separately ordered accessory kits:

- Indoor wall-mountable installation (section 3.6.1)
- Wooden pole-mountable installation (section 3.6.2)

3.6.1 Indoor Wall-Mountable Installation

This section provides instructions on how to mount the GX quad-band unit on indoor concrete walls using the AK-GX-QUAD-BRKT-INDOOR accessory kit (ordered separately).

Corning Optical Communications

Note the following:

- The GX indoor bracket accessory kit is designed for installations on concrete walls only.
- The GX unit is mounted with the connectors facing UPWARDS (as opposed to all other installation types).
- Weight: GX (per unit) = 147 lb (66 kg); Bracket = 28.7 lb (13 kg)

The accessory kit includes the following items:

Item	Quantity	
Top Wall Rack (6 holes)	1	
Bottom Wall Rack (8 holes)	1	
Mounting Ground Support	1	
Sideboard	2	
M6x16 Hex Socket Head Cap screws – required for sideboard assembly	8	
Spring Washer	8	
Plain Washer	8	

Kit Items for GX Indoor Bracket | Table 3.4

Additional required tools

- Electric screwdriver with hex bits
- Electric drill with a 12 mm diameter head
- Spanner (0.31-in for tightening GX M8 nuts)

To mount GX in Indoor Installation

- Determine the installation location so that there is enough free space for proper ventilation and maintenance access.
- Referring to Figure 3.6, dismantle the mat and mounting hooks from the GX by unscrewing the corresponding M5x12 screws. Save those screws for the following step.

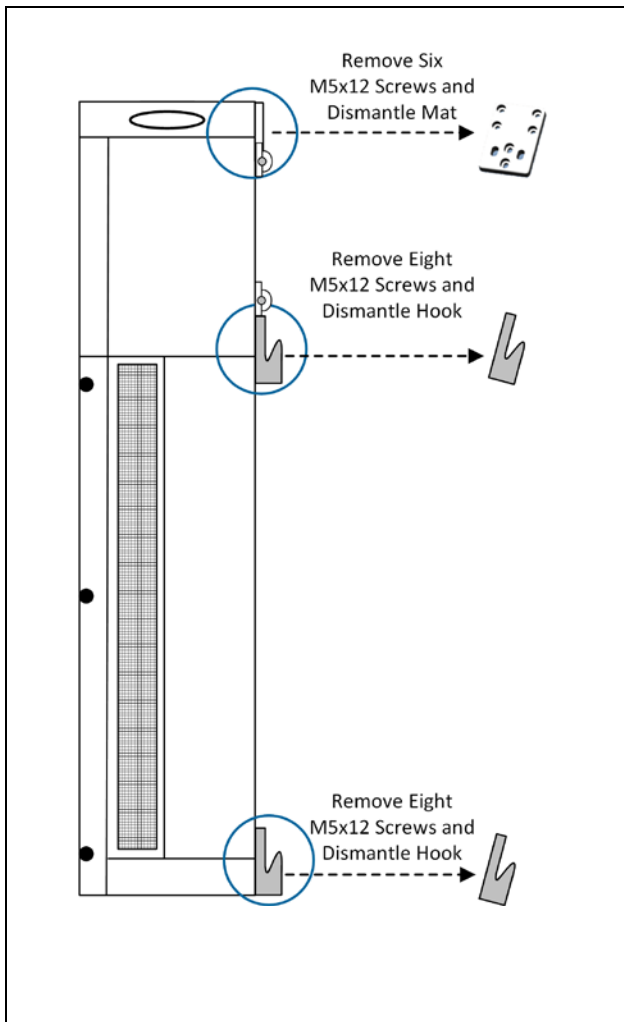

Disassembling Mounting Hooks | Figure 3.6

3. Assemble the top wall rack on the GX using six M5×12 hex socket head cap screws (previously removed and set aside).
4. Assemble the bottom wall rack on the GX using eight M5×12 hex socket head cap screws (previously removed and set aside).

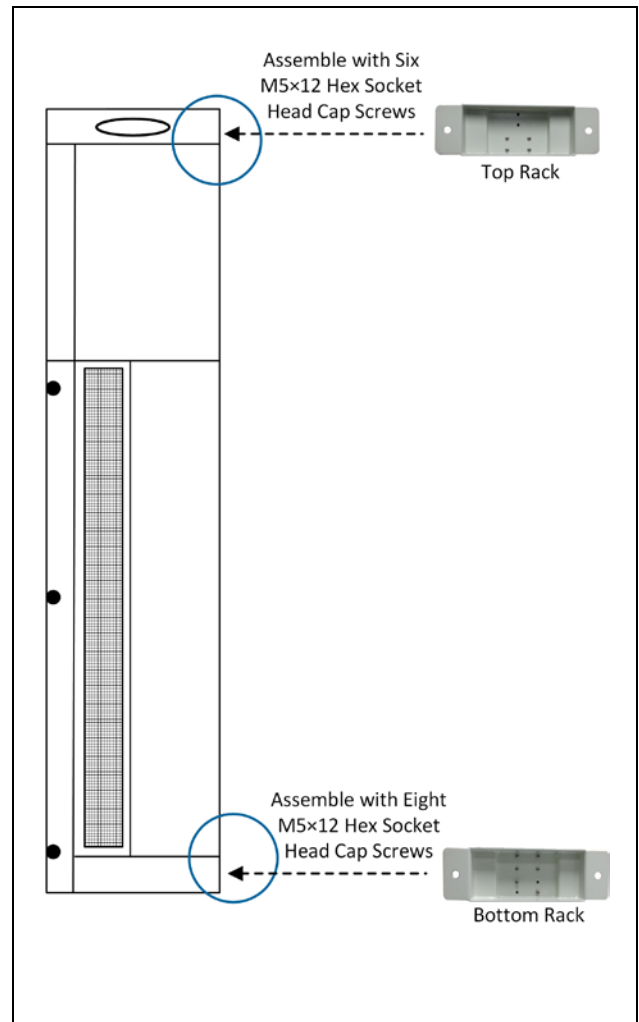

Assembling Top and Bottom Racks | Figure 3.7

5. Place the GX unit on the mounting ground support with the connectors facing upwards.
6. Secure the GX to the mounting ground support with the two sideboards using eight M6×16 hex socket head cap screws (provided with the accessory kit).

Figure 3.8 provides an overview of the mounted GX unit.

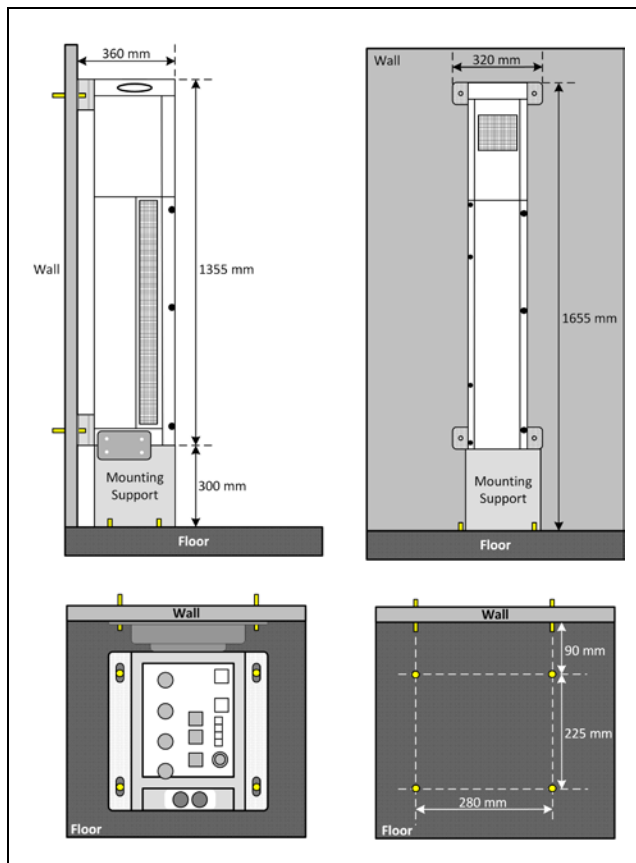

Overview of Mounting Procedure | Figure 3.8

7. Position the GX and bracket assembly so that the mounting brackets face the wall. Refer to “side view” (top left image) and “front view” (top right image) shown in Figure 3.8.
8. Using the screw holes as a template, drill the required holes in the floor and wall (drill directly through the screw holes). Refer to “Front View” (top-right image) and “Top View” (bottom-left image) shown in Figure 3.8.

Note: *Eight M10 masonry bolts are required (not provided).*

9. Insert masonry M10 bolts into drilled holes and tighten. Refer to Figure 3.9.

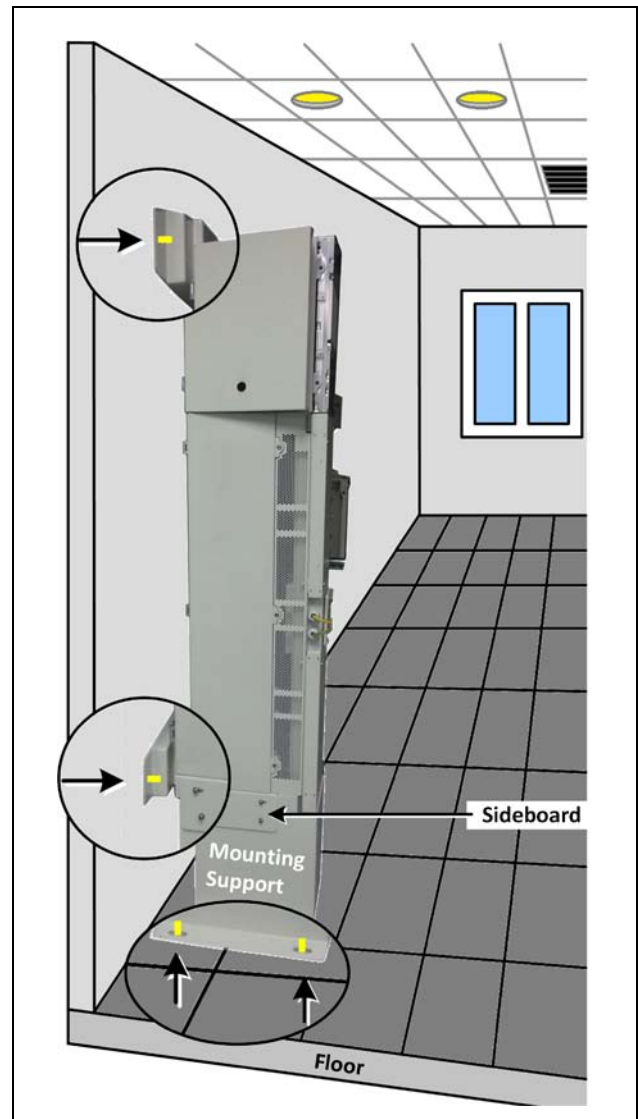

Location of Inserted Masonry Bolts | Figure 3.9

3.6.2 Wooden Pole-Mountable Installation

This section provides instructions on how to mount the GX quad-band unit on wooden poles using the GX wooden-pole bracket accessory kit (ordered separately).



Note the following:

- This bracket is designed for installations on wooden poles only.
- Up to two GX units can be mounted on a single bracket, one on each side.
- Two people are required for mounting each GX unit onto the bracket.

- The GX unit is mounted onto the pole with the connectors facing downwards.
- Weight: 147 lb (66 kg); Bracket = 30.9 lb (14 kg).



Package Contents

Check your package contents to verify that the items in the packing list are included and that there are no signs of external damage.

Item	Quantity	
Pole Bracket Top	1	
Pole Bracket Middle	1	
Pole Bracket Bottom	1	
M6×16 Hex Socket Head Cap Screw (Bracket Assembly)	8	
Spring Washer	8	
Plain Washer	8	
5/8-in Self-Tapping Screws (Wood Assembly)	4	

GX Wooden Pole-Mountable Bracket Package Contents | Table 3.5

Additional required items (not included)

Item	Quantity	
5/8-in Screws and Nuts for wooden pole assembly. Screws must meet requirement for related installation environment.	4	
M8×30 Screws for GX assembly, included in GX package	2	
Electric Screwdriver with the proper heads	1	-
Electric Drill with appropriate head	1	-
Spanner (0.31-in for tightening GX M8 nuts)	1	-
Hex Key	1	-

Additional Required Items | Table 3.6

Figure 3.10 and Figure 3.11 show an overview of a single-mount and dual-mount GX installation.

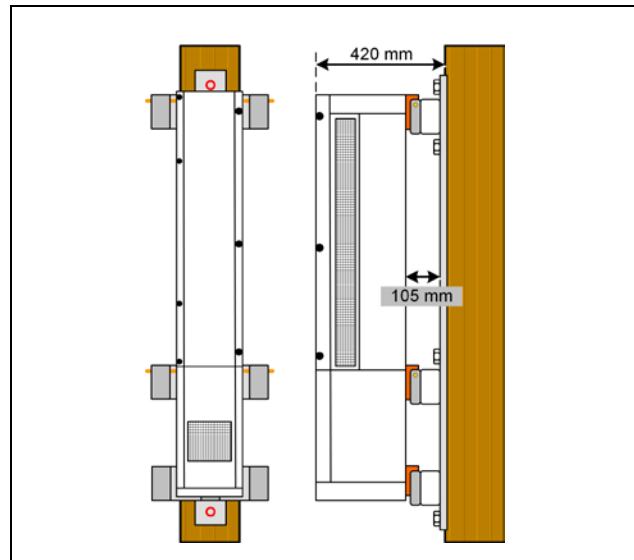

Pole-Mountable GX – Single Mount | Figure 3.10

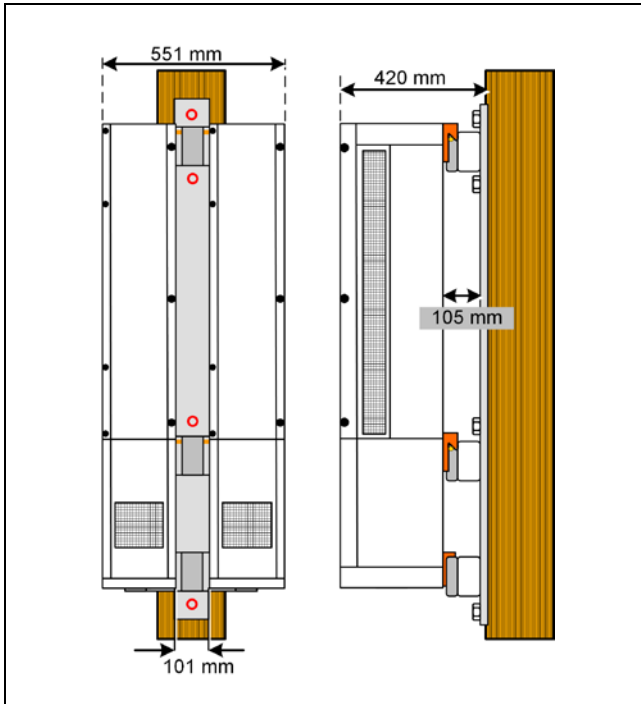

Pole-Mountable GX – Dual Mount | Figure 3.11

To mount a GX unit on a wooden pole

1. Using the eight M6x16 hex socket screws and the relevant washers, assemble the three parts of the pole bracket as shown in Figure 3.12.

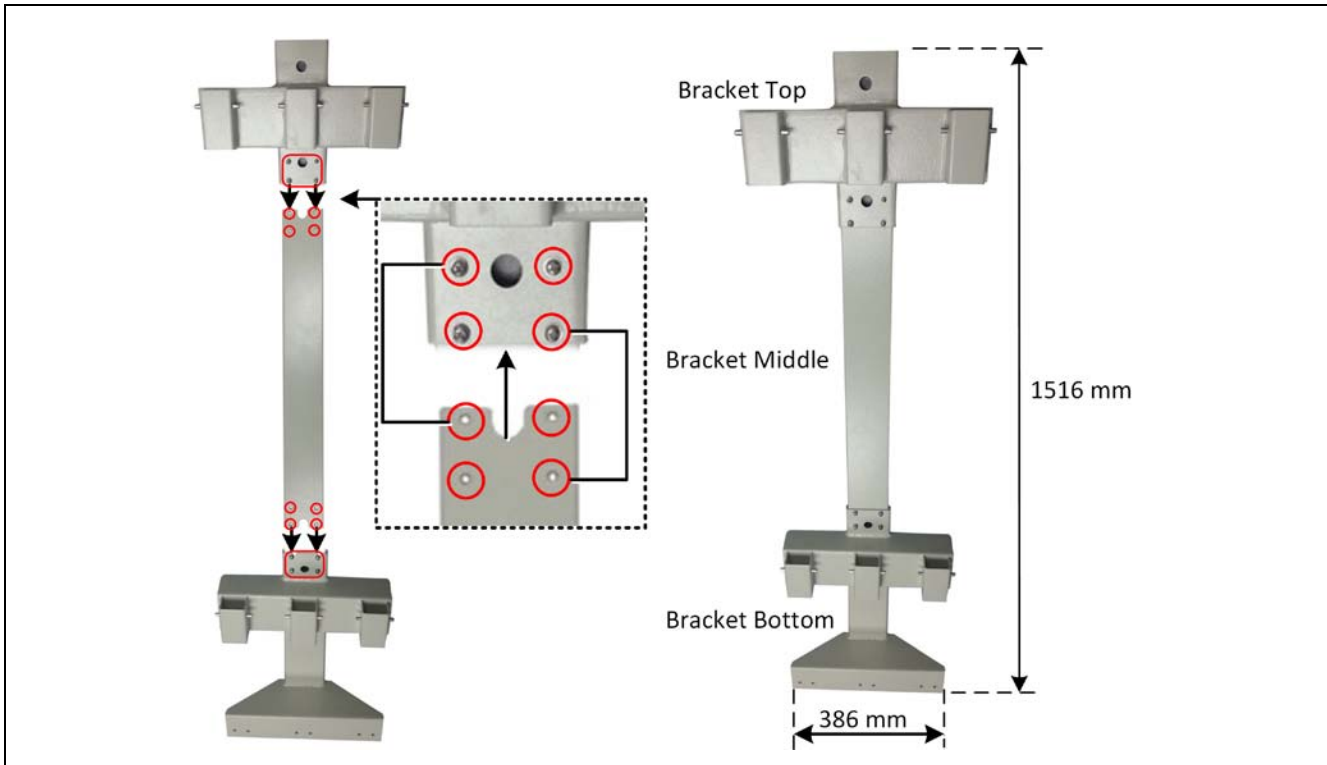

Wooden Pole Bracket Assembly | Figure 3.12

2. Select the appropriate location for the bracket according to the following criteria:

- General surroundings
- Make sure that the bracket is installed high enough to ensure convenient access to the GX connectors located on the underside of the unit when mounted.
- Ventilated and easy-to-reach area
- Proximity to the antenna in order to minimize cable loss

3. Referring to Figure 3.13, mount the wooden pole bracket according to the following steps:

- Drill four holes in the pole according to the distances shown in Figure 20.
- Position the bracket onto the wooden pole and screw in the 5/8-in screws (provided) into the top and bottom mounting holes.
- Screw in the two additional screws into the remaining middle mounting holes and tighten.

Note: The distance between the bracket bottom screw and the ground must be at least 20 mm.

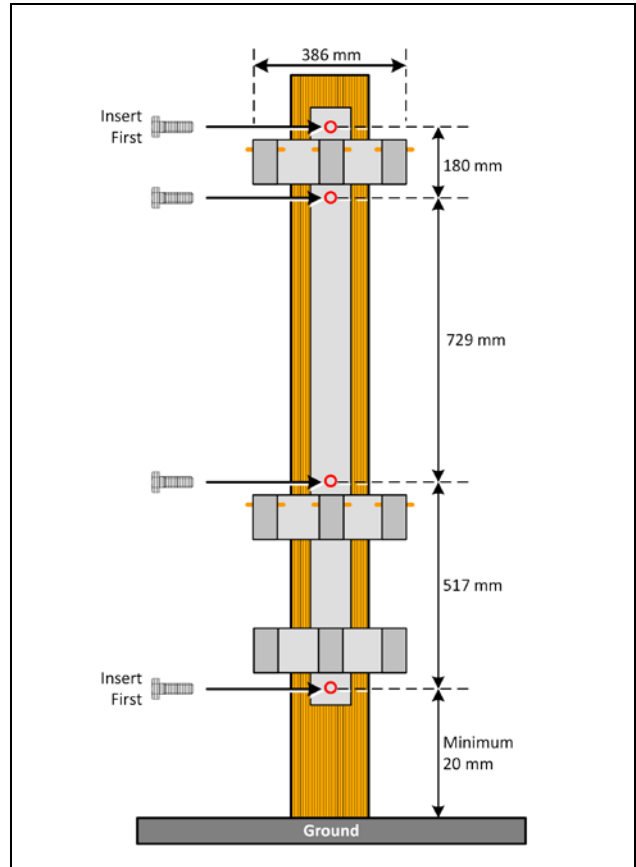

Mounting the Bracket | Figure 3.13

4. Mount the GX unit onto the bracket: - referring to Figure 3.14, hang the GX on the pins protruding from the relevant top and center parts (depending on single or dual installation) of the bracket.

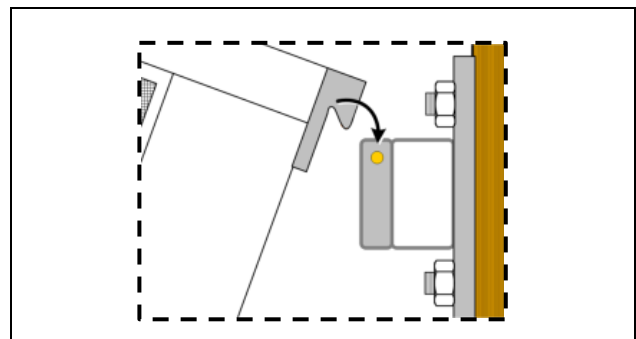

Hooking GX onto Bracket | Figure 3.14

Note: For single GX unit installation – unit is mounted onto middle of bracket (Figure 3.15); For Dual GX unit installations – units are mounted on the sides of the bracket (Figure 3.16).

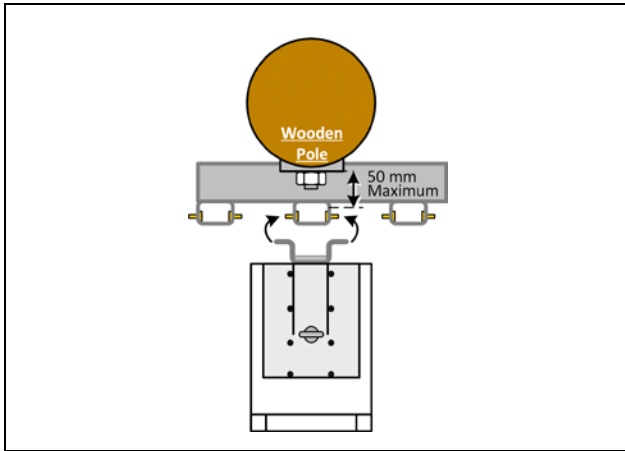

Single-Mounted GX Unit | Figure 3.15

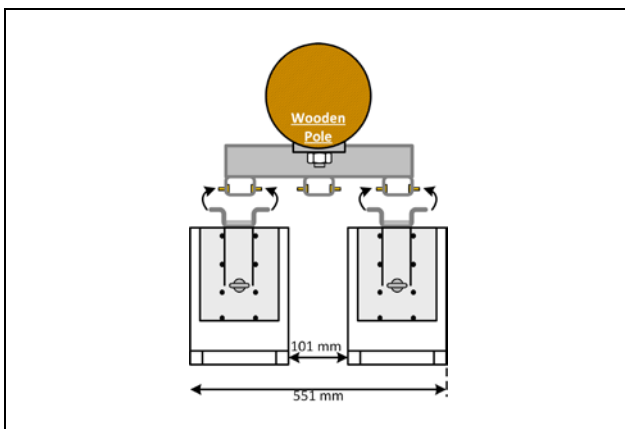

Dual-Mounted GX Units | Figure 3.16

3.7 GX Connections

IMPORTANT! CABLE DRIP LOOPS RECOMMENDED.

It is highly recommended that every horizontal cable entry to the equipment forms a 'U' before its entry to the equipment. Water on the cable will drip down at the bottom of the loop and will not accumulate at the equipment connectors.

3.7.1 Grounding Connections

WARNING! This unit must always be grounded. Consult an appropriate electrical inspection authority or an electrician if you are uncertain that suitable grounding is available. **DO NOT CONNECT POWER BEFORE GROUNDING!**

Note: An internationally acceptable color code of the ground connection wire is green/yellow.

To ground the GX unit

1. Connect the supplied copper wire (AWG #6) GND cable to the GND connector and the equipment rack or building earth.
2. Ground the GX unit by connecting the provided "earth wire" of the power cord to the ground terminal of the AC supply.

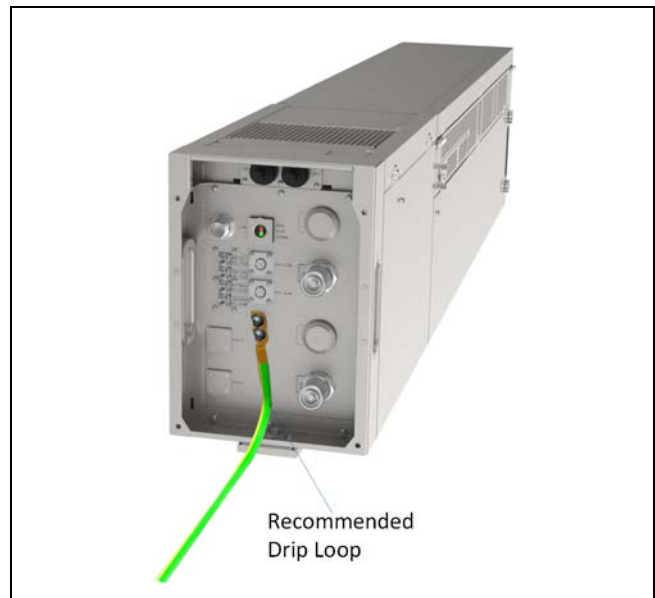

GX Grounding Connection | Figure 3.17

3.7.2 Fiber Connections

IMPORTANT! OptiTap® pull-out force ranges from a few lbs to 50+ lbs with the dust cap or connector installed. This prevents damages caused to the DAS unit.

Connect the GX OP OptiTap port to one of the OCH front panel "Link" ports (via F/O patch panel), using an OptiTap cable assembly (ordered separately). MIMO units require two fiber connections, where each one must be connected to a different optical module.

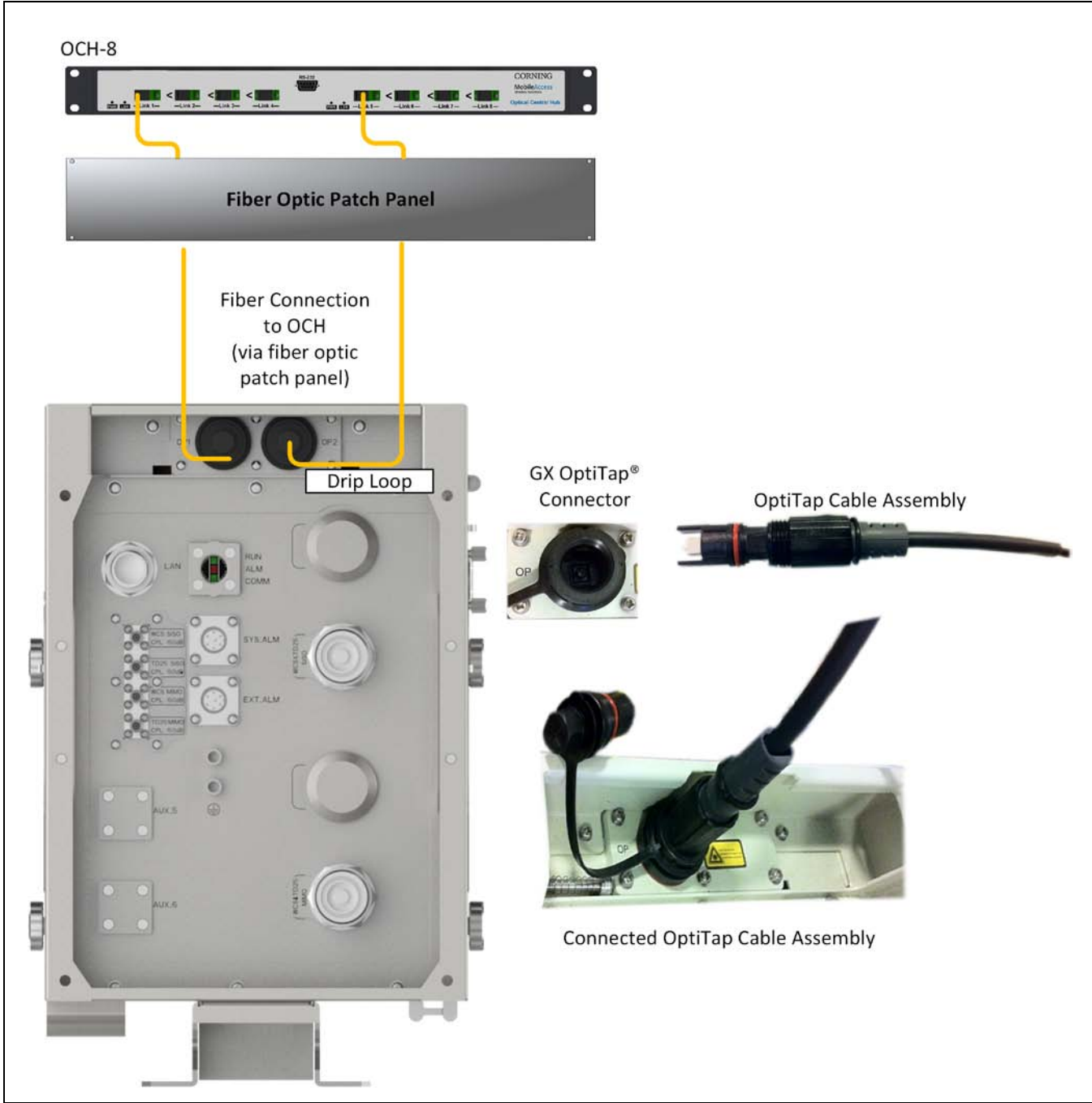

GX Dual-Band (MIMO) Fiber Optic Connections | Figure 3.18

3.7.3 RF Connections

CAUTION! Any open RF port on GX or improper connection between GX RF ports and combiner inputs, will damage GX internal power amplifier after the equipment is powered on. Make sure all connections are performed correctly before powering.

Note: When deployed with GX quad-band (with EAWS) units, the GX dual-band high-band RF services can be combined with the quad-band low-band services using the dual-band combiner (P/N: AK-GX-LH-COMB).

For direct connections to DAS antennas

1. Using the required coax cables, connect the GX RF port(s) to the service antennas. One for SISO models and two for MIMO models.
2. Ensure lightning protection for each antenna port.
3. Waterproof all RF ports (recommended drip loops).
4. Terminate any unused GX and RF ports.

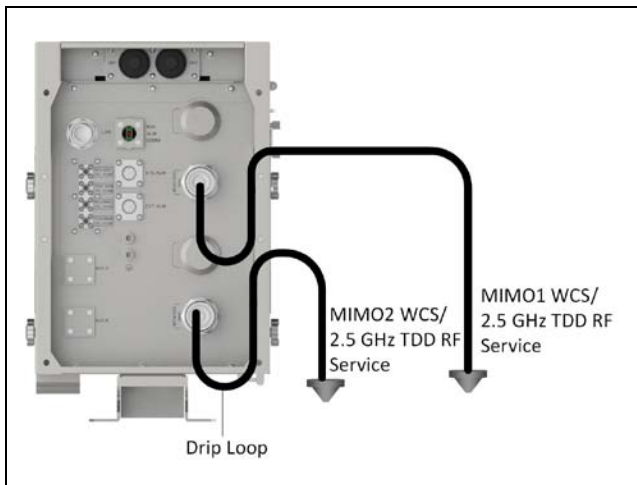

Illustration of GX Dual-Band (MIMO) Direct RF Connection to DAS | Figure 3.19

For connections via GX external low/high-band combiner:

1. Referring to Figure 3.20 and using the provided DIN-to-DIN cables, connect the GX RF service antenna port to one of the two external combiners input ports (Port1/Port2).

Note: MIMO models require to external combiners.

2. Connect the combiners' 7/16 DIN output connector to the DAS antenna.

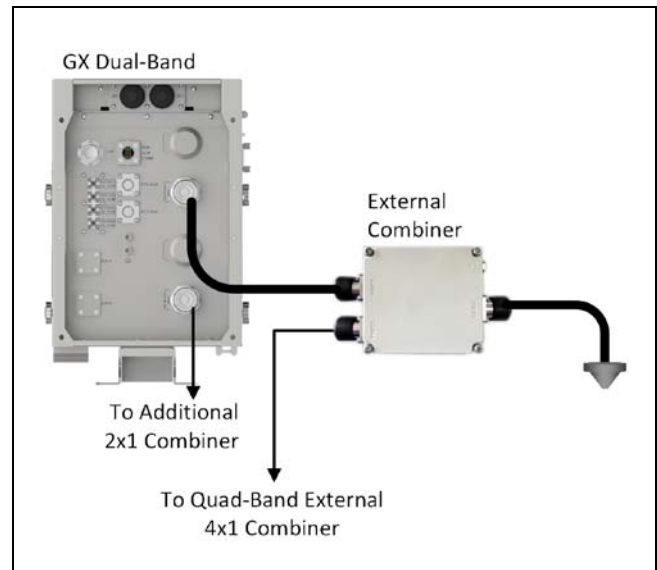

Illustration of GX and Dual-Band External Combiner Connections | Figure 3.20

3.7.4 Power Connections

CAUTION! Any open RF port on GX or improper connection between GX RF ports and filter input ports will damage GX internal power amplifier after the equipment is powered on. Make sure all connections are performed correctly before powering.

3.7.4.1 AC Models

To connect AC power

1. Unscrew the two screws of the side panel (shown in Figure 3.21) and open to access the power connector

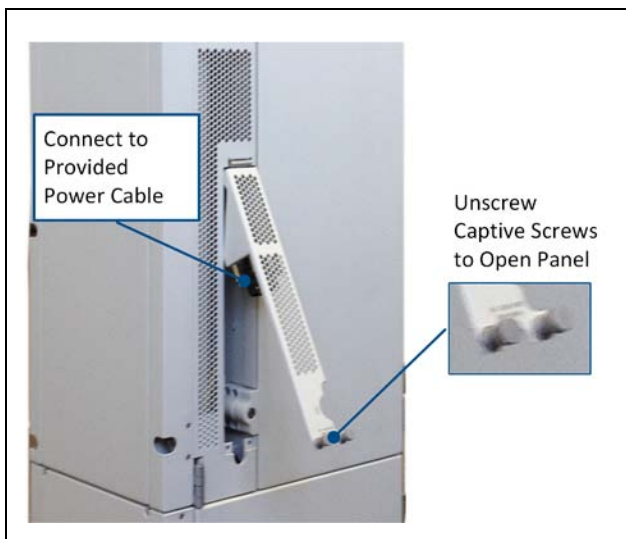

GX AC Model Power Connector | Figure 3.21

2. Connect the supplied power cable to the power supply port:

- Power input: VAC 100-240/47-63 Hz
- Maximum power consumption: 1100 W
- Maximum current consumption: 11 A maximum

3.7.4.2 DC Models

Verify the following before connecting DC power:

- DC power supply is turned off
- DC cable (not provided) meets the following requirements:
 - Supports required voltage and current specifications: -40 to -57 VDC and 27.5 A maximum
 - Cable diameter ranges between 7 and 14 mm

- Cable lug specs (refer to Figure 3.22 for example of compliant lug) :

- Hole size: 1/4-in
- Hole spacing: 5/8-in

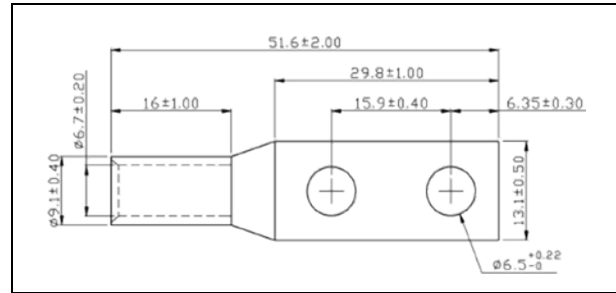

Example of Compliant DC Cable Lug | Figure 3.22

To connect DC power

1. Open DC power chamber panel by loosening four M3 screws, as shown in Figure 3.23.

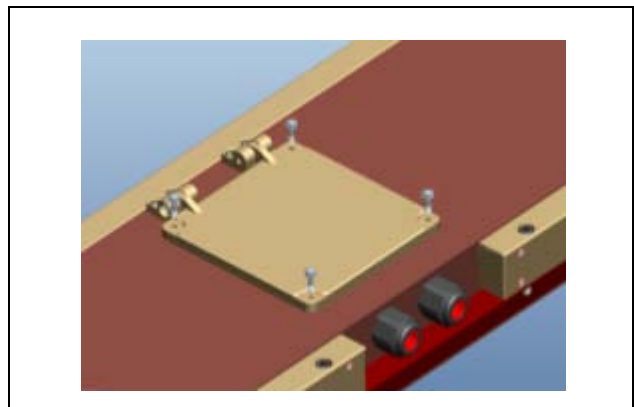

Opening DC Chamber Panel | Figure 3.23

2. Referring to Figure 3.24, remove retaining nut, insert DC power cable through tubing gasket (provided), then carefully route the power cable into the chamber (through hole) and connect the lug to terminal (make sure right DC polar is connected).
3. Tighten retaining nuts.

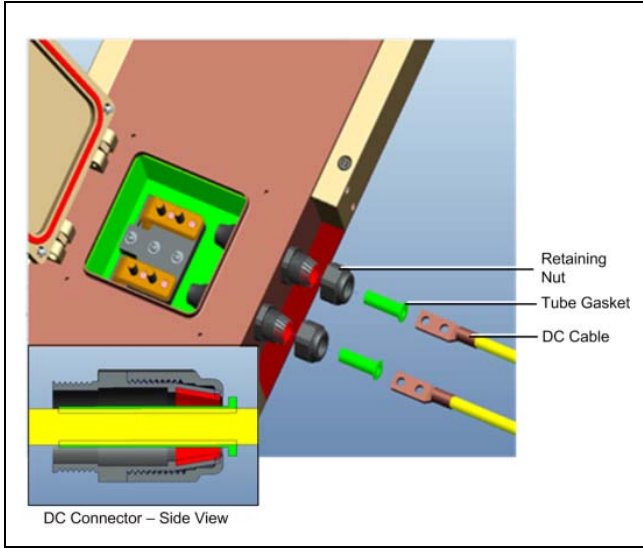

Connecting Power Cord to Terminal | Figure 3.24

4. Referring to Figure 3.25, use nut to tighten lug to terminal.

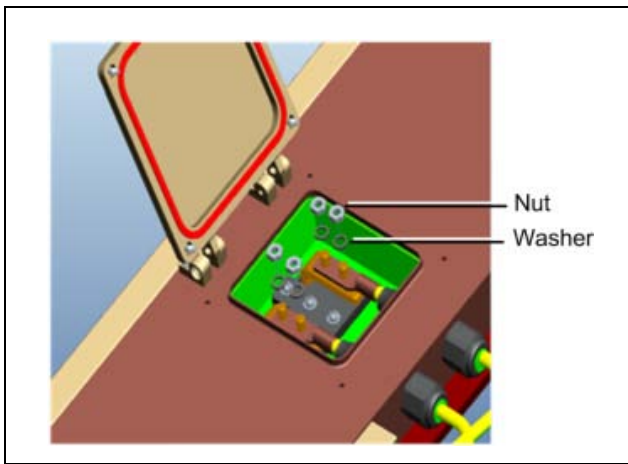

Tightening Lug to Terminal | Figure 3.25

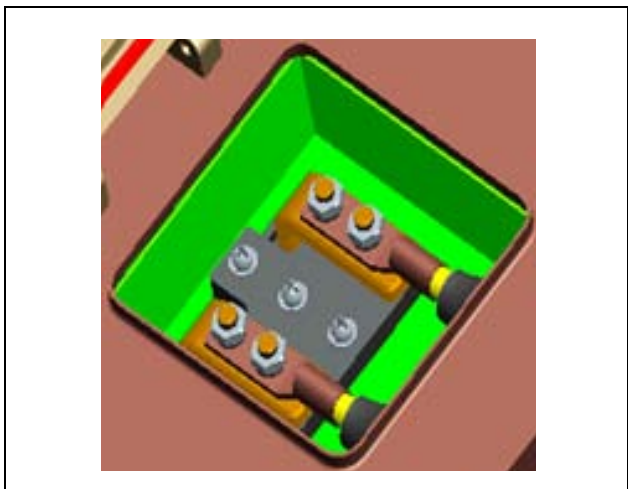

Securing Lug and Terminal | Figure 3.26

5. It is highly recommended to have power cords fixed or tighten with an enclosure-type element. Additional holes are left for that purpose. See Figure 3.33.

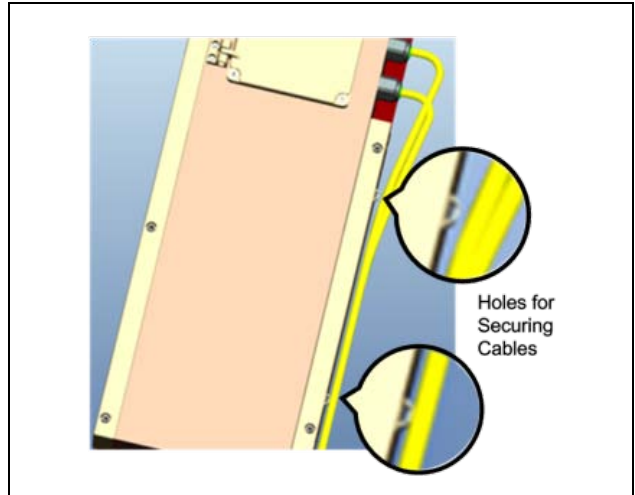

Fixed Power Cable | Figure 3.27

3.7.5 External Alarm Connections

The GX dual-band external alarm port supports up to four dry-contact alarm connections from external sources (incoming outputs). The alarms can be connected any time, before or after the system is powered-on.

Note: After being connected, the external alarms must be enabled from the web management application (see SC-450 user manual – v7.5 and higher).

Pin Number	Description
1	EXT_ALM1
2	EXT_COM1
3	EXT_ALM2
4	EXT_COM2
5	EXT_ALM3
6	EXT_COM3
7	EXT_ALM4
8	EXT_COM4

External Alarm Pin-Out Description | Table 3.7

3.7.6 System Alarm Pin-Out Description

The GX dual-band system alarm pin-out connector supports three relay alarm connections. GX dual-band status alarms can be relayed via a network or modem connection.

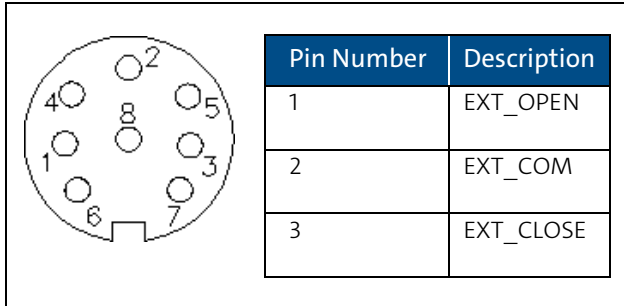

System Alarm Pin-Out Description | Table 3.8

3.8 Verifying Normal Operation

Upon powering up the GX dual-band remote unit:

- Confirm the fans are working after powering.
- Refer to GX status LEDs (described in Section 1.4, Table 1.2) and verify normal operation.



GX Dual-Band Status LEDs | Figure 3.28

4 APPENDICES

4.1 Appendix A: System Specifications

RF Parameters

Supported services

Technologies	Frequency Range		
	Service/Band	Uplink	Downlink
LTE	WCS	2305-2315	2350-2360
LTE	TDD 2.5 GHz	2496-2690	2496-2690

Supported Services | Table 4.1

RF Parameters per Service (40 W)

Notice: The manufacturer's rated output power of this equipment is for the composite band or a single carrier operation. For situations when multiple carrier signals are present, the rating for each carrier would have to be reduced by $10 \cdot \log(N)$, where N is the number of the transmitted channels. The gain reduction for each carrier shall be done on the headend, and not by an attenuator at the output of the device.

RF Parameters	LTE WCS		LTE 2.5 GHz TDD	
	DL	UL	DL	UL
Nominal Bandwidth (MHz)	10	10	60 MHz Between 2496 to 2690	60 MHz Between 2496 to 2690
Mean Output Power (dBm)	46		46	
Maximum Output Power (dBm)				
1 Carrier (Composite)	46		46	
2 Carriers	43		43	
4 Carriers	40		40	
Nominal Passband Gain (dB)	66 (OCH to GX)	50 (GX to OCH)	66 (OCH to GX)	50 (GX to OCH)
Mean Gain (dB)	66	50	66	50
Gain Range (dB)	30	30	30	30
Maximum Pin (dBm) at AGC Threshold	-20 (at OCH)	-54	-20 (at OCH)	-54
Maximum Intermod Distortion (dBm)	-13		-13	
NF (dB) at Maximum Gain		5		5
VSWR	1.5:1			1.5:1
Gain Flatness/Ripple (dB)	+/- 2.0			

Coupling Specifications

Frequency (MHz)	Typical Coupling* (dB)
WCS	-50.0
2.5 GHz TDD	-50.0

*Depending on the band, the actual coupling value may slightly vary.

Optical Specifications

Parameter	Value
Maximum Optical Budget	6 dBo
Optical Return Loss	> 50 dB
Optical Loss per Mated-pair Connectors	0.5 dB (maximum)
Optical Connector	OptiTap® fiber optic waterproof connector
Optical Automatic Gain Control Range	-2 to -10 dBm
Fiber Type	Single-mode: 9/125 μm
Wavelength	1310 nm, 1550 nm + WDM

Physical Specifications

Parameter	Value									
Ports	OptiTap fiber optic waterproof connector; One for SISO and two for MIMO RF DIN duplexed female connectors; One for SISO and two for MIMO Two 1/4-in grounding screws for AWG #18 GND cable One RJ45 waterproof LAN connector									
Power	<table border="0"> <thead> <tr> <th></th> <th>Dual-Band SISO</th> <th>Dual-Band MIMO</th> </tr> </thead> <tbody> <tr> <td>AC:</td> <td>Input: VAC 100 - 240/47-63 Hz Maximum power consumption: 750 W</td> <td>1100 W</td> </tr> <tr> <td>DC:</td> <td>Input: VDC (-40) to (-57) Maximum power consumption: 750 W</td> <td>1100 W</td> </tr> </tbody> </table>		Dual-Band SISO	Dual-Band MIMO	AC:	Input: VAC 100 - 240/47-63 Hz Maximum power consumption: 750 W	1100 W	DC:	Input: VDC (-40) to (-57) Maximum power consumption: 750 W	1100 W
	Dual-Band SISO	Dual-Band MIMO								
AC:	Input: VAC 100 - 240/47-63 Hz Maximum power consumption: 750 W	1100 W								
DC:	Input: VDC (-40) to (-57) Maximum power consumption: 750 W	1100 W								
Physical Characteristics	Weight: 147 lb (66.6 kg) Mounting: Wall-mountable or pole-mountable Dimensions: 53.15 x 8.9 x 12.4 in (1350 x 226.06 x 314.96 mm)									
Cooling Feature	Active heat dissipation (fan)									

Environmental Specifications

Parameter	Value
Operating Temperature	-40 to +70°C (-40 to +158°F)
Humidity	≤ 95 percent
Enclosure	NEBS OSP Class 4 rated (enclosure protected from elements and waterproofing)

4.2 Appendix B: Ordering Information

Note: The information listed below is updated up to the publishing date. Refer to the GX 40 W dual-band datasheet (CMA-585-AEN) for the most updated ordering information.

GX Dual-Band Remotes

Services Supported	Part Number	Description
WCS/2.5 GHz TDD MIMO	GX-WCSM2500M-40	GX Dual-Service MIMO for WCS and 2.5 GHz TDD solution supporting 40 W output for AC powering.
	GX-WCSM2500M-40-DC	GX Dual-Service MIMO for WCS and 2.5 GHz TDD solution supporting 40 W output for DC powering.
WCS/2.5 GHz TDD SISO	GX-WCSS2500S-40	GX Dual-Service SISO for WCS and 2.5 GHz TDD solution supporting 40 W output for AC powering.
	GX-WCSS2500S-40-DC	GX Dual-Service SISO for WCS and 2.5 GHz TDD solution supporting 40 W output for DC powering.

Optical Central Hub (OCH)

Part Number	Description
OCH-4-WDM	Optical Central Hub for SISO services, supporting four SISO remote units, single-mode (WDM)
OCH-8-WDM	Optical Central Hub for SISO or MIMO services, supporting eight SISO or four MIMO remote units, single-mode (WDM)

Extended Radio Interface Modules (RIMe)

Note: GX remotes deployed with the Corning® optical network evolution (ONE™) solution are supported by extended radio interface modules (RIMe) only.

Part Number	Description
RIMe-25T	Extended Radio Interface Module with support for the 2500 MHz TDD band; RF Input: -11 to 37 dBm
RIMe-W23	Extended Radio Interface Module with support for the WCS 2300 MHz band; RF Input: -11 to 37 dBm

SC-450 Controller

Note: GX dual-band remotes require an SC-450 controller for management purposes also when deployed with the Corning® optical network evolution (ONE™) solution.

Part Number	Description
SC-450	System controller

Accessories

Part Number	Description
AK-GX-LH-COMB	GX Accessorized 2-to-1 External Diplexer for low- and high-band
ERFCv2-OCH	Extender RF Cables from RIX to IFU
AK-ONE-HE-GX-INTBOX	GX Accessories ONE™ Headend to GX interface box
AK-RIU4-OCH-CABLES	Accessory Kit Cables for RIU-4 to OCH, four QMA to QMA R/A cables, 1 m
AK-GX-QUAD-PWR-CABLE	GX AC Electrical Power Cable for US GX quad-band
AK-GX-QUAD-ELEC-ADP-AC	AC Electrical Junction Adapter IP67 rated
AK-GX-QUAD-BRKT-INDOOR	GX Accessory Kit including bracket for wooden pole-mountable option
AK-GX-QUAD-BRKT-WDPOLE	GX Accessory Kit including bracket with ground support for indoor concrete wall-mounting option

OptiTap® Cable Assemblies

Part Number	Description
434401EB4R2005M-P	OptiTap® to SC APC 5 m
434401EB4R2030M-P	OptiTap to SC APC 30 m
434401EB4R2100M-P	OptiTap to SC APC 100 m
434401UB4H3005M-P	OptiTap to SC APC Cable Assembly, indoor/outdoor, riser-rated 5 m
434401UB4H3030M-P	OptiTap to SC APC Cable Assembly, indoor/outdoor, riser-rated 30 m
434401UB4H3100M-P	OptiTap to SC APC Cable Assembly, indoor/outdoor, riser-rated 100 m OptiTap to SC APC cable

Note: The listed OptiTap cables are available on demand within a week of the order. Custom length cables require longer lead times. For more information, contact your Corning account manager.

Notes:

The logo consists of the word "CORNING" in a white, serif, all-caps font, centered within a solid blue square.

Corning Optical Communications LLC • PO Box 489 • Hickory, NC 28603-0489 USA
800-743-2675 • FAX: 828-325-5060 • International: +1-828-901-5000 • www.corning.com/opcomm

Corning Optical Communications reserves the right to improve, enhance, and modify the features and specifications of Corning Optical Communications products without prior notification. A complete listing of the trademarks of Corning Optical Communications is available at www.corning.com/opcomm/trademarks. All other trademarks are the properties of their respective owners. Corning Optical Communications is ISO 9001 certified. © 2017 Corning Optical Communications. All rights reserved. CMA-601-AEN / October2017

P/N 709C021601 Rev A00