

**Manual**  
**Absolute Control**  
**Remote control ABC-01**

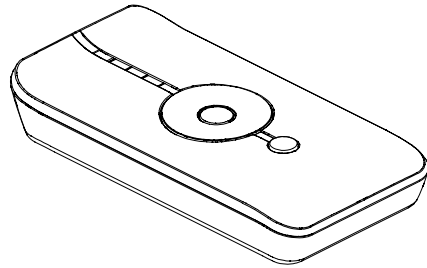

**coulisse**

**WARNING:** Important safety instructions. Follow all instructions, since incorrect installation can lead to severe injury.

**WARNING:** Do not make repairs yourself. Do not attempt to open the device or disassemble it. You run the risk of electric shock and voiding the limited warranty. No user-serviceable parts are inside.



**1. General information**

The ABC-01 is an intelligent remote to operate Coulisse automation blinds.

**1.1 Performances**

ABC-01	
Battery	CR2032 1.5V
Channels	5
Max. blinds per channel	infinite
Range (inside building)	20m, 2 concrete walls
Frequency	2.4 GHz
Weight	56 grams

**1.2 Buttons**

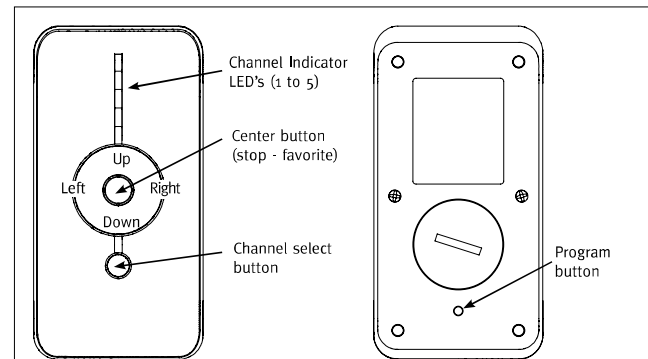

**1.3 Changing the battery**

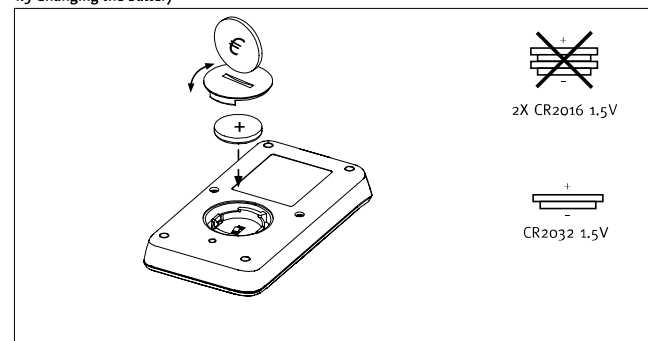

**2. Programming**

To program a blind:

1. Set blind in program mode, chapter 2.1
2. Program the blind, chapter 2.2
3. Exit the program mode, chapter 2.1

**2.1 Set a blind in program mode**

Setting a blind in program mode can be done in three ways. If a blind is in program mode it will show a stepping motion. The blind can still be operated with the buttons. If a program action is confirmed, the blind stops stepping for 3 seconds. A blind will exit the program mode automatically after 4 minutes.

**1. By hand: press the program button on the blind**

It is possible to set multiple blinds in program mode and program them simultaneously

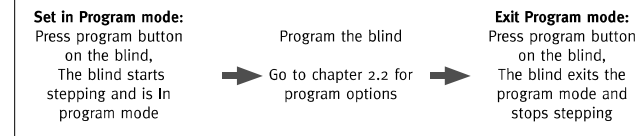

**2. By remote: Single select mode**

The single select mode is a patented method to set a blind in program mode by remote control. When a remote and blind are in single select mode, the blind can be operated, paired to one or more channels and programmed. Other blinds are disconnected from the remote, until the single select mode has ended.

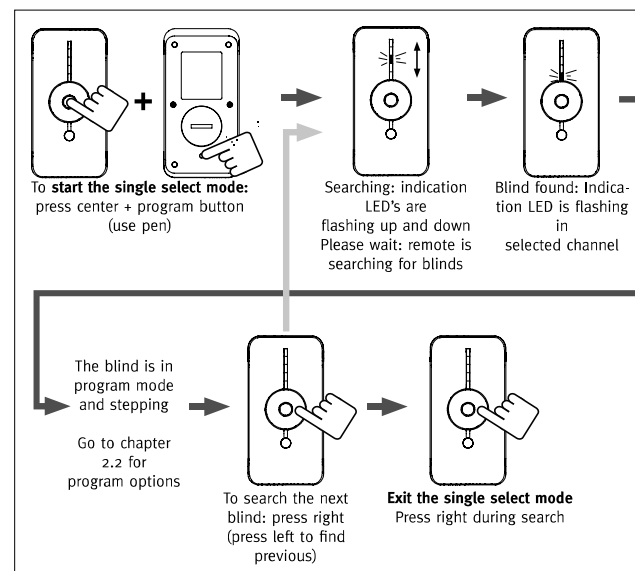

**3. By remote: Channelselct**

Channel select is a method to set all blinds that are paired in the same channel, into program mode.

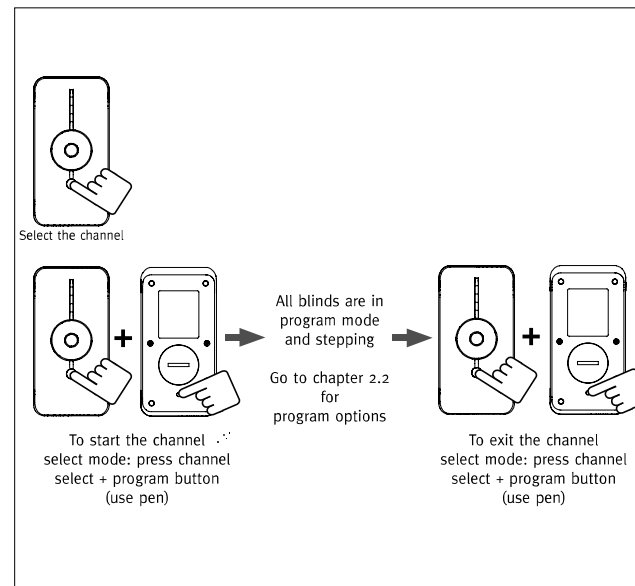

**2.2 Programming a blind**

**1. Pair a blind to a channel**

To pair a blind to a channel, the blind must be in program mode. See chapter 2.1 how to set a blind in program mode and exit program mode.

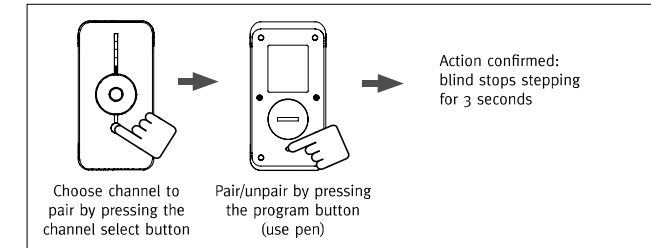

**2. Pair multiple blinds simultaneously to a channel or other remote**

To pair multiple blind simultaneously to a channel or other remote, all blinds must be in program mode. See chapter 2.1 how to set a blind in program mode and exit program mode. Pairing multiple blinds simultaneously to a channel is not possible for Singleselect

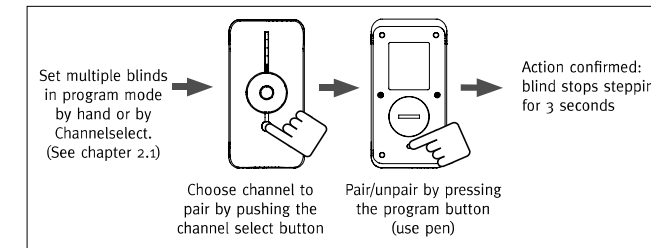

**3. Set the favorite position**

To program a blind, the blind must be in program mode. See chapter 2.1 how to set a blind in program mode and exit program mode.

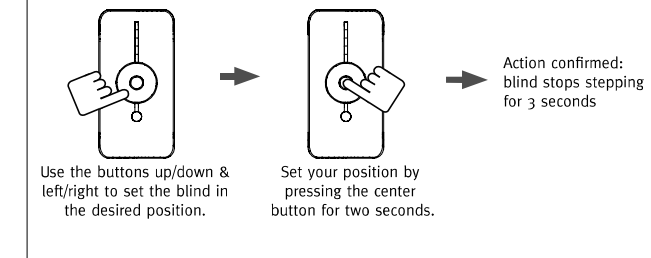

**4A. Switch the blind's direction of rotation**

To program a blind, the blind must be in program mode. See chapter 2.1 how to set a blind in program mode and exit program mode. Example: when you press left/down on the remote and your blind moves to the right/up, you have to switch the rotation direction of the blind.

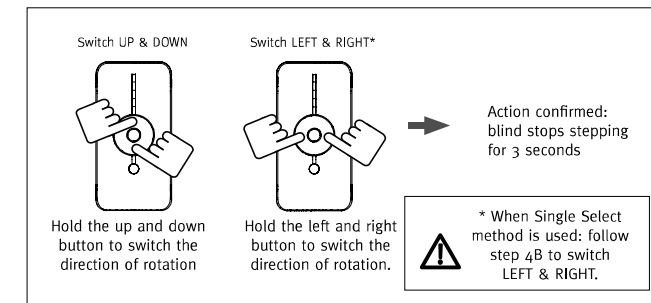

**4B. Single Select mode: Switch direction of rotation for panel and vertical blinds**

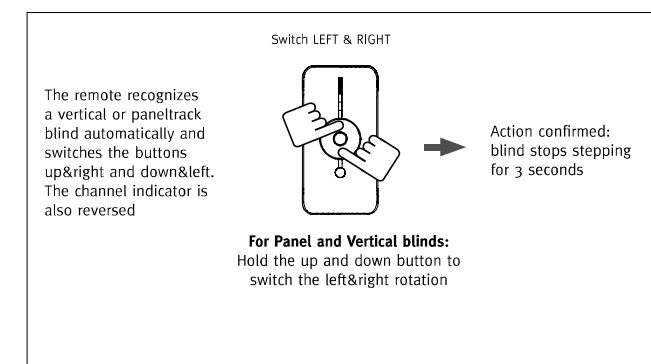

### 5. Set blind in BatteryMode (Greenmode)

To program a blind, the blind must be in program mode. Important: BatteryMode can be only turn on by using **Single Select method**, see chapter 2.1 how to set a blind in program mode en exit program mode by single select. The RF-unit in the blind forwards radio signals to increase the range of the remote.  
To save energy the signal forwarding is switched off in BatteryMode.

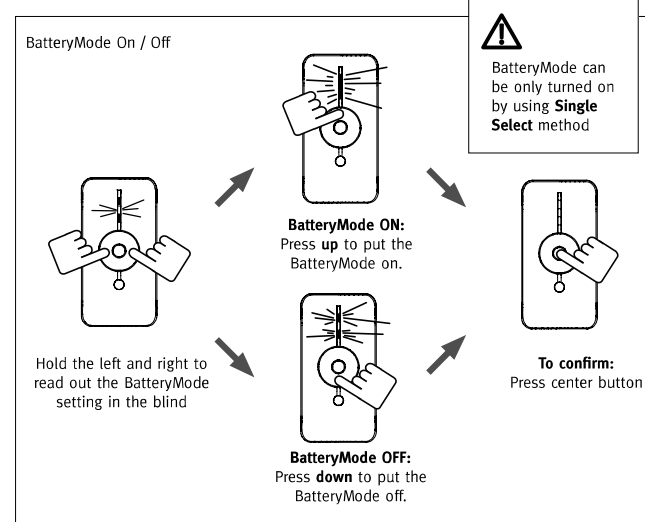

### 3. Operating

#### 3.1 Select a channel

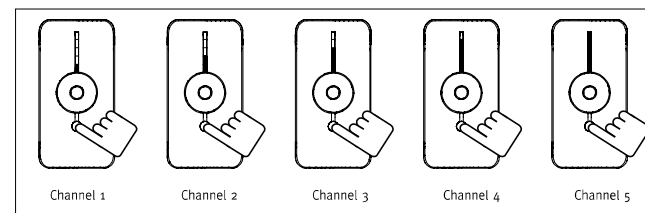

#### 3.2 Operate a blind

Press the buttons shortly for small movements, press the buttons for 2 seconds and the blind will move automatically. Press the stop/center button to stop the movement.

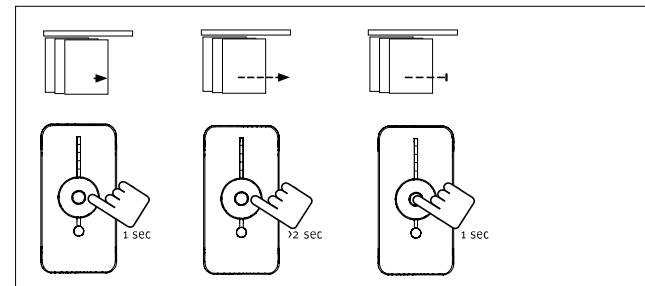

#### Buttons

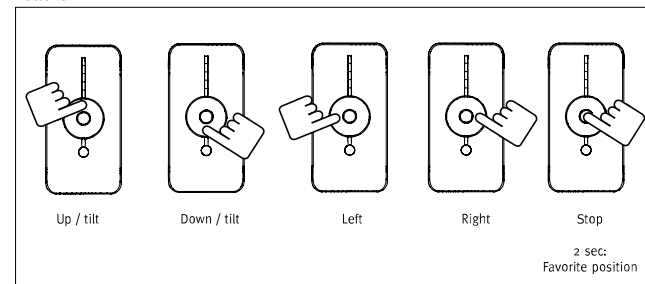

### 4. Remote Holder

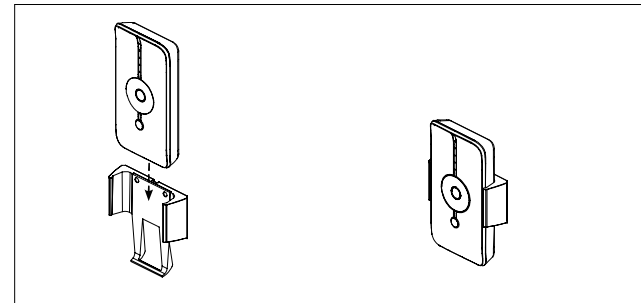
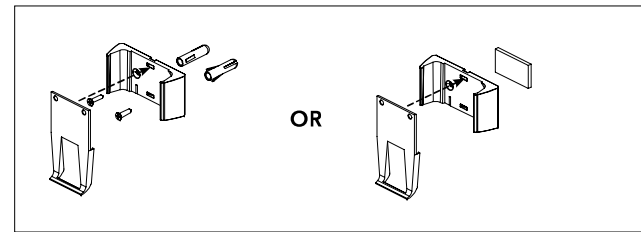

### 5. Tips & Troubleshooting

Please check [www.coulisse.nl](http://www.coulisse.nl) for the latest tips and troubleshooting guide.

### 6. Safety & Cleaning

#### 6.1 Safety

**WARNING:** Do not make repairs yourself. Do not attempt to open the device or disassemble it. You run the risk of electric shock and voiding the limited warranty. No user-serviceable parts are inside.

- Do not let children play with the blind and/or remote control
- Do not paint the device
- Keep the device dry. Precipitation, humidity, and all types of liquids or moisture can contain minerals that will corrode electronic circuits. If your device does get wet, remove the battery, and allow the device to dry completely before replacing the battery.
- Do not drop, knock, or shake the device. Rough handling can break internal circuit boards.

#### 6.2 Cleaning

Follow these general rules when cleaning the outside of the device and its components:

- Make sure the device is unplugged.
- Use a damp, soft, lint-free cloth. Avoid getting moisture in openings.
- Don't use aerosol sprays, solvents, alcohol, or abrasives.

### 7. Service & Support

**WARNING:** Do not make repairs yourself. Do not attempt to open the device or disassemble it. You run the risk of electric shock and voiding the limited warranty. No user-serviceable parts are inside.

#### Online Resources

For the latest information and updated manuals go to [www.coulisse.nl](http://www.coulisse.nl).

#### Obtaining Warranty Service

First follow the advice in this booklet and then go to your local dealer.

If the product appears to be damaged or does not function properly, go to your local dealer for instructions on how to obtain warranty service.

Disclaimer:

© Copyright Coulisse

All rights reserved. No part of this publication may be reproduced, stored in a retrieval system, or transmitted, in any form, by any means, electronic, mechanical, photocopying, recording, digital or otherwise without the written permission of the publisher.

Although this manual has been composed with the most care, Coulisse B.V. does not accept any responsibility for damage due to mistakes and/or faults in this manual.

Coulisse B.V. reserves the right to revise the manual and to revise and/or changes its content at any time, without obligation to notify any person or entity of such revisions or changes.

The most recent version replaces older versions of this manual. The most recent version is available at [www.coulisse.nl](http://www.coulisse.nl) or contact your Coulisse contact person.

We invite you to send remarks and comments about this manual to [manuals@coulisse.nl](mailto:manuals@coulisse.nl).

**coulisse**

Coulisse B.V., Vonderweg 48, 7468 DC Enter, The Netherlands

24.8.2009