



Coway

Water Filtration Device **CHP-04AR/L/U**

- This product can not be used if the voltage is different from that mentioned in the rating plate.
- For your safety and proper use of the product, please read this User's Manual before use.
- Warranty card is included in this User's Manual.



FEATURES

1. Convenient two-in-one faucet

A convenient two-in-one faucet is applied so that cold water and room water can be extracted from one faucet.

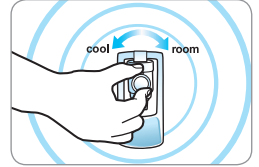

2. Front draining system

It is convenient as it can drain the cold water / room water / hot water from the front side without moving the product when you open the front draining door.

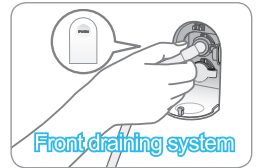

3. Fine carbon particle reduce

At the last stage of the filtration, inno-sense filter is applied to reduce carbon particles that sometimes come from the post carbon filter.

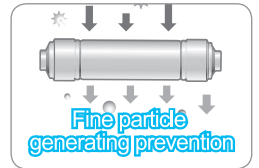

4. Mass gutter applying

It doesn't need the extra secondary draining tank as it applies the mass gutter and it is convenient as it can extract the room water with a big vessel directly.



5. Ultra-violet lamp circulates the treated water inside the reservoir tank.

This ultra-violet lamp circulates the treated water inside the reservoir tank.



DEAR CUSTOMERS

Thank you for using **Coway Water Filtration Device**.

Please read this Users' Manual to use and maintain the product correctly.

If you encounter a problem while using the product, you may solve the problem referring to the User's Manual. As this manual contains the product warranty card, please keep it in a safe place.

This system (CHP-04AR/L/U) conforms to NSF/ANSI 42 for aesthetic chlorine reduction and NSF/ANSI 53 for VOC reduction as verified and substantiated by test data.

This system (CHP-04AR/L) conforms to NSF/ANSI 58 for the reduction of pentavalent arsenic, barium, cadmium, selenium, radium 226/228, trivalent chromium, hexavalent chromium, lead, nitrate/nitrite as verified and substantiated by test data.

This system (CHP-04AR/L) registered in california.

See performance data sheet for individual contaminants and reduction performance.

This system (CHP-04AR/L) is acceptable for treatment for influent concentrations of no more than 27 mg/L nitrate and 3 mg/L nitrite in combination measured as N and is certified for nitrate/nitrite reduction only for water supplies with a pressure of 280 kPa(40 psi) or greater.

CONTENTS

FOR INFORMATION

SAFETY INFORMATION	3
Electricity safety	3
Installation safety.....	4
Operation safety.....	5
Others.....	6
PARTS NAME	7
WATER FILTRATION PROCESS	9

MAINTENANCE

INSTALLATION	19
CLEANING METHOD	21
Storage tank.....	21
Gutter.....	23
FILTER REPLACEMENT	24
FILTER REPLACEMENT METHOD	25

HOW TO USE

INSTALLATION PRECAUTIONS	13
INDICATORS AND CONTROLS	15
HOW TO USE	17
To drink the cold water.....	17
To drink the hot water	17
To drink the room water	18

OTHERS

TROUBLESHOOTING	27
SPECIFICATIONS	28
WATER FLOW DIAGRAM	29
PERFORMANCE DATA SHEET	30
WARRANTY CARD	41

SAFETY INFORMATION

Be careful to keep this safety information.

Please read this safety information carefully to ensure your safety and to prevent possible property damage or loss.



Danger
If not observed, serious injury or even death could occur.



Warning
If not observed, serious injury or property damage could occur.

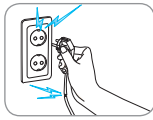

Caution
If not observed, slight injury or property damage could occur.

Electricity safety

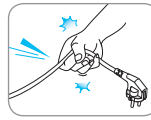

 Do not use a damaged power cord or plug, and loose outlet.
Otherwise, electric shock or fire may occur as a result.



 Do not pull the power cord.
Otherwise, electric shock or fire may occur as a result.

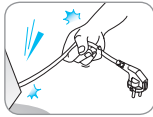

 Do not carry the unit by its power cord.
Otherwise, electric shock or fire may occur as a result.



 Do not touch the power plug with a wet hand.
Otherwise, electric shock or fire may occur as a result.

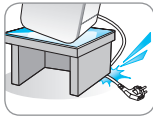

 Do not forcefully bend the power cord or put it under a heavy object to prevent it from being damaged or deformed.
Otherwise, electric shock or fire may occur as a result.



 Do not connect and pull out the power plug repeatedly.
Otherwise, electric shock or fire may occur as a result.

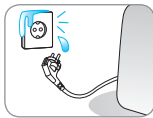

 If the electric outlet is wet, carefully unplug the unit and let the electric outlet completely dry before subsequent use.
Otherwise, electric shock or fire may occur as a result.



 Unplug the product before repair, inspection, or parts replacement.
Otherwise, electric shock or fire may occur as a result.



⚠ Remove any dust or water off in the pin and contacts of the power plug.

Otherwise, electric shock or fire may occur as a result.

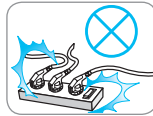

⚠ Do not plug into an outlet that is being used by several other appliances. Use an electrical outlet dedicated.

Otherwise, fire may occur as a result.

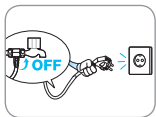

⚠ When you don't use for a long time, close the main water supply valve and unplug.

Otherwise, electric shock or fire may occur as a result.

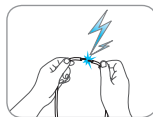

⚠ Do not attempt to repair or modify the power cord at your discretion.

Otherwise, electric shock or fire may occur as a result.



⚠ In the case the power cord is damaged, do not replace the cord yourself. Call Coway Service Center to have it replaced.

Otherwise, electric shock or fire may occur as a result.

Installation safety

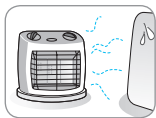

⚠ Do not install near a heating device.

Otherwise, fire may occur as a result.

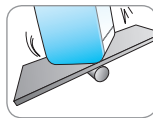

⚠ Do not install the product on a sloped floor.

Injury to the user or damage to the unit may result.

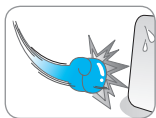

⚠ Do not press the product by constraint or impact.

Injury to damage to the unit may result.

⚠ The filtration device installation shall comply with applicable state and local regulations.

SAFETY INFORMATION



If not observed, serious injury or even death could occur.

Danger



If not observed, serious injury or property damage could occur.

Warning



If not observed, slight injury or property damage could occur.

Caution

Operation safety

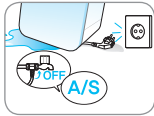

⚠ When the water is coming inside of the product or there is a puddle on the product, call Service Center after closing the supplying valve and unplugging.

Otherwise, electric shock may occur as a result.

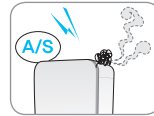

⚠ If our product produces a strange noise or odd smell, immediately unplug from the electrical outlet and call our Service Center.

Otherwise, electric shock or fire may occur as a result.



⚠ Do not put the candle, a light for cigarette on the products.

Otherwise, fire may occur as a result.

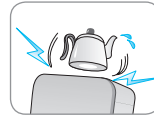

⚠ Do not place any containers with water, medicine, food, small metallic objects, or any flammable material on the top of the product.

In the case foreign material gets inside the product, electric shock, fire, product damage may occur as a result.

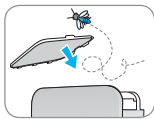

⚠ Use after closing the water tank cover completely inside of the product.

The buck or the foreign body can be entered.



⚠ To drink the filtered water, change the filter according to the filter replacement cycle.

If you use the expired filter, the filter performance is lowered.



⚠ When you don't use for a long time, use after draining the saved water completely and emptying the newly room water once again.

The saved water can be polluted.



⚠ Do not allow hot water to come in contact with the human body.

Otherwise, burn may occur as a result.



Danger



Warning



Caution

Others

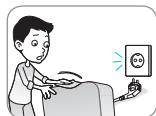

- ⚠ **Clean after unplugging.**
Otherwise, electric shock or fire may occur as a result.



- ⚠ **Do not clean by spraying the water directly or don't wipe the product using the benzene and thinner.**

Otherwise, electric shock or fire may occur as a result.



- ⚠ **Do not repair, disassemble, or modify.**
Otherwise, electric shock or product damage may occur as a result.

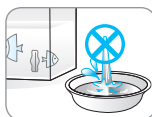

- ⚠ **Do not use filtered water for the water exchange of an aquarium or a fishbowl.**

The room water through the membrane isn't suitable for the fish's life environment as it removed the ionic material. In some cases, fishes might even die.

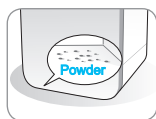

- ⚠ **After moving the product or replacing the inno-sense filter, the black powder can be remained in the inner bottom of the water tank.**

It is quiet harmless as the powder of the activated carbon used in the inno-sense filter was flowed out for improving the water tastes.

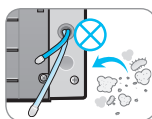

- ⚠ **Do not use with water that is microbiologically unsafe or of unknown quality without adequate disinfection before or after the system.**

PARTS NAME

| Front |

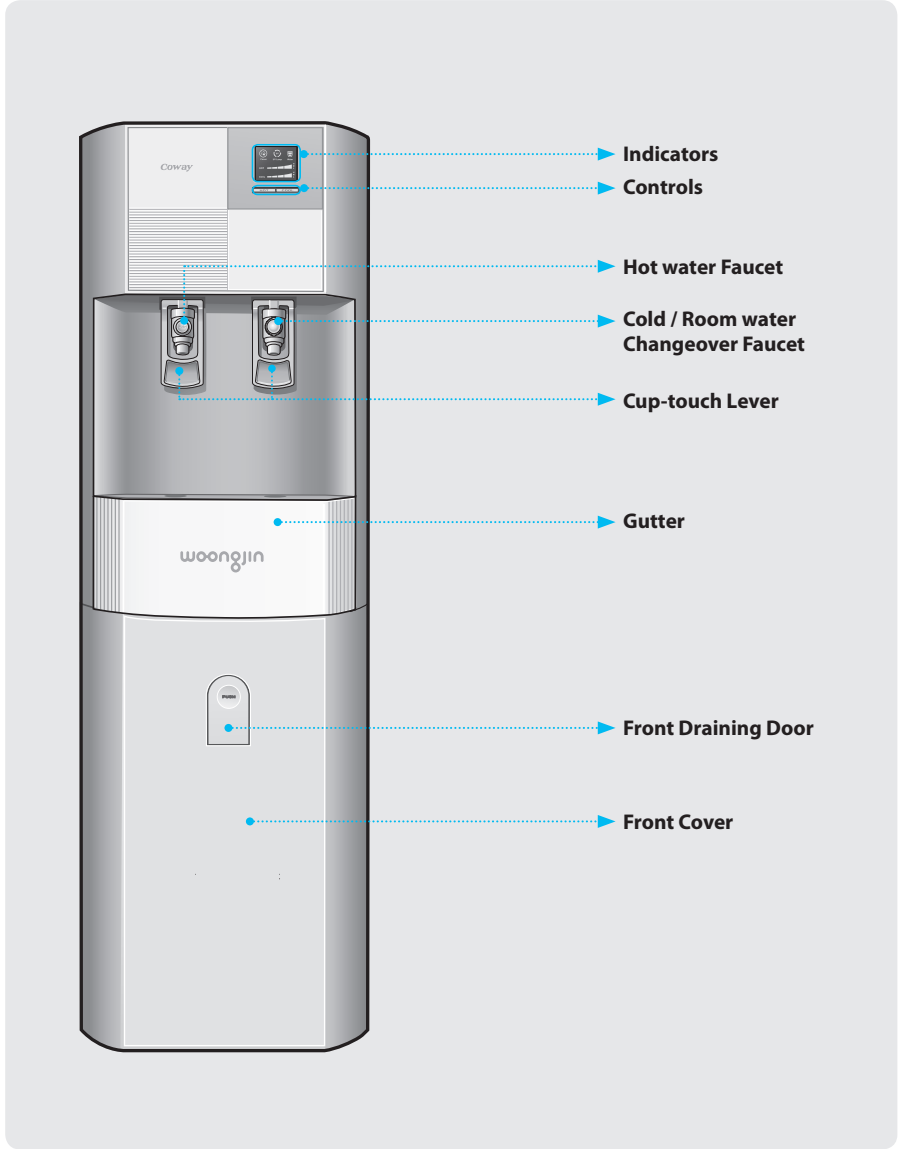

| Rear |

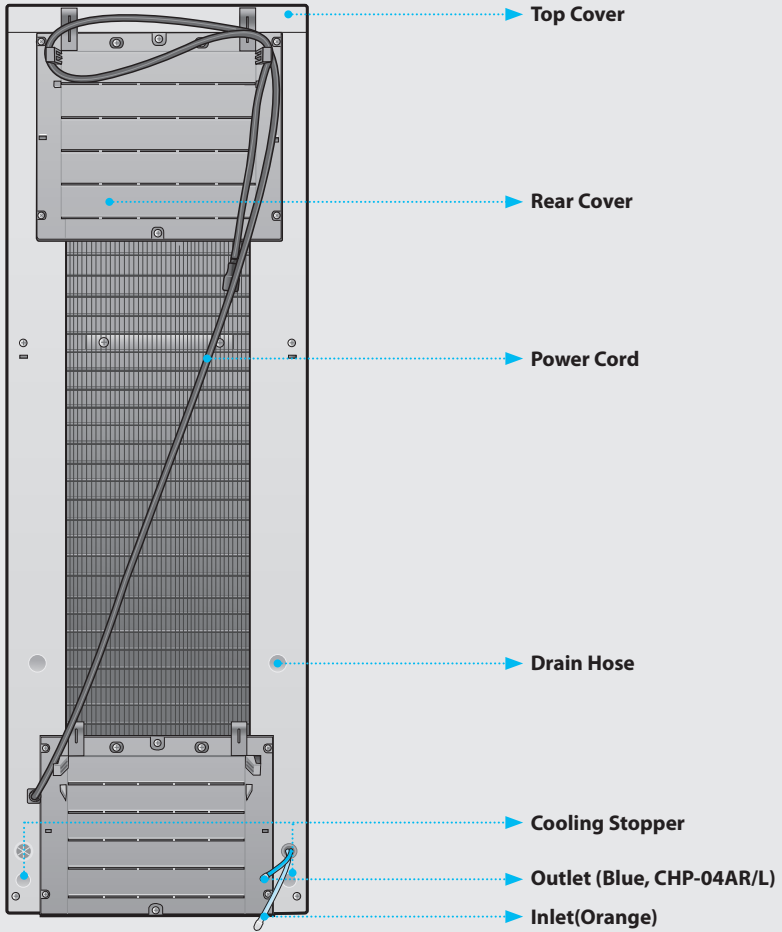

WATER FILTRATION PROCESS

The filter is the core technology of the filtration system.

If you don't use qualifying filter or if you use an old filter that has expired, the system performance may degrade.

■ The 5-step water filtering system (CHP-04AR/L) ■

Step 1 : PLUS SEDIMENT FILTER

This plus sediment filter has the functions to reduce infusible particles from feed water and to protect membrane and pre-carbon filter from being plugged.

Step 2 : PRE-CARBON FILTER

This Pre-Carbon filter has the function to reduce aesthetic chlorine, odor, volatile organic compounds(VOC's).

Step 3 : RO MEMBRANE FILTER

RO membrane filter has the function to reduce water contaminants such as pentavalent arsenic, barium, cadmium, selenium, radium 226/228, trivalent chromium, hexavalent chromium, lead, nitrate/nitrite.

Step 4 : INNO SENSE FILTER

This inno-sense filter has the functions to reduce smell induction material and to improve taste of water. It also has the function to reduce aesthetic chlorine, volatile organic compounds(VOC's).

STEP 5 : ULTRA-VIOLET LAMP

This ultra-violet lamp circulates the treated water inside the reservoir tank.

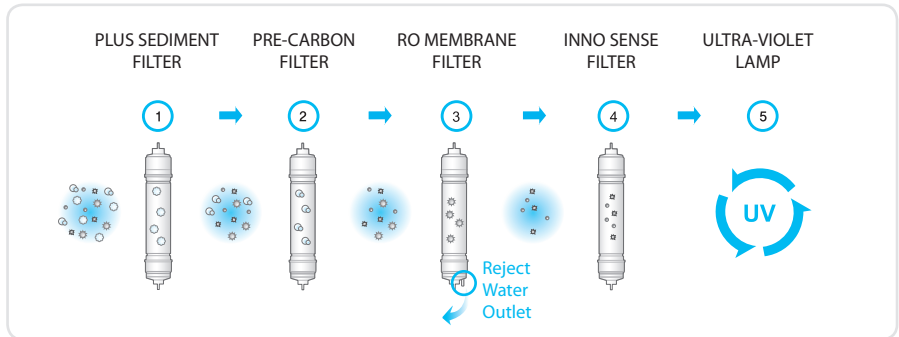

Tips

Uses of reject water

- The reject water should be used for cleaning the restroom, the house, clothes, or purposes other than drinking.
- Never use the reject water for a drinking or a cooking.

■ The 6-step water filtering system (CHP-04AR/L) ■

Step 1 : PLUS SEDIMENT FILTER

This plus sediment filter has the functions to reduce infusible particles from feed water and to protect membrane and pre-carbon filter from being plugged.

Step 2 : PRE-CARBON FILTER

This Pre-Carbon filter has the function to reduce aesthetic chlorine, odor, volatile organic compounds(VOC's).

Step 3 : RO MEMBRANE FILTER

RO membrane filter has the function to reduce water contaminants such as pentavalent arsenic, barium, cadmium, selenium, radium 226/228, trivalent chromium, hexavalent chromium, lead, nitrate/nitrite.

Step 4, 5 : FINE POST-CARBON FILTER

This Fine Post-Carbon filter has the functions to reduce smell induction material and to improve taste of water. It also has the function to reduce aesthetic chlorine, volatile organic compounds(VOC's).

STEP 6 : ULTRA-VIOLET LAMP

This ultra-violet lamp circulates the treated water inside the reservoir tank.

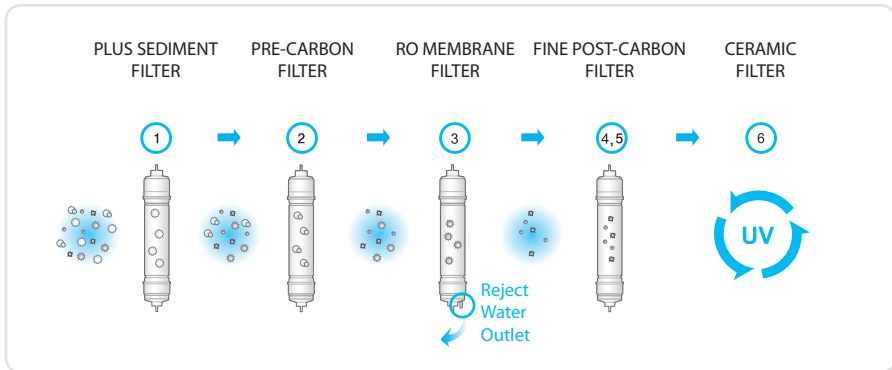

WATER FILTRATION PROCESS

■ The 5-step water filtering system (CHP-04AU) ■

Step 1 : PLUS SEDIMENT FILTER

This plus sediment filter has the functions to reduce infusible particles from feed water and to protect membrane and pre-carbon filter from being plugged.

Step 2 : PRE-CARBON FILTER

This Pre-Carbon filter has the function to reduce aesthetic chlorine, odor, volatile organic compounds(VOC's).

Step 3 : INNO SENSE FILTER

This inno-sense filter has the functions to reduce smell induction material and to improve taste of water. It also has the function to reduce aesthetic chlorine, volatile organic compounds(VOC's).

Step 4 : UF MEMBRANE FILTER

STEP 5 : ULTRA-VIOLET LAMP

This ultra-violet lamp circulates the treated water inside the reservoir tank.

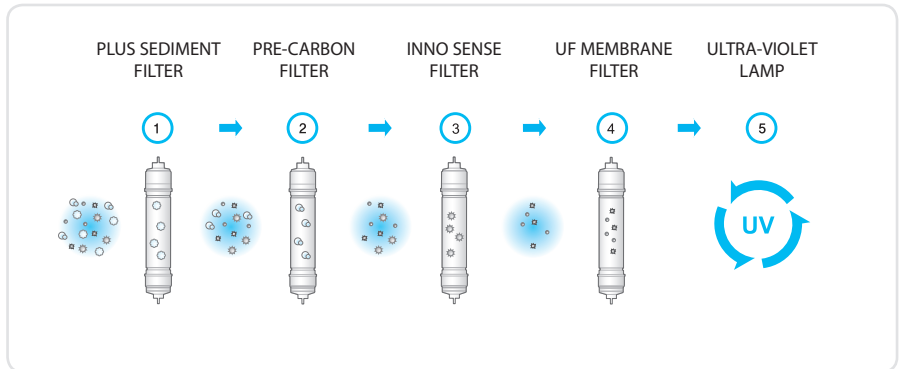

■ The 5-step water filtering system (CHP-04AU) ■

Step 1 : PLUS SEDIMENT FILTER

This plus sediment filter has the functions to reduce infusible particles from feed water and to protect membrane and pre-carbon filter from being plugged.

Step 2 : PRE-CARBON FILTER

This Pre-Carbon filter has the function to reduce aesthetic chlorine, odor, volatile organic compounds(VOC's).

Step 3 : POST-CARBON FILTER

This post-carbon filter has the functions to reduce smell induction material and to improve taste of water. It also has the function to reduce aesthetic chlorine, volatile organic compounds(VOC's).

Step 4 : UF MEMBRANE FILTER

STEP 5 : ULTRA-VIOLET LAMP

This ultra-violet lamp circulates the treated water inside the reservoir tank.

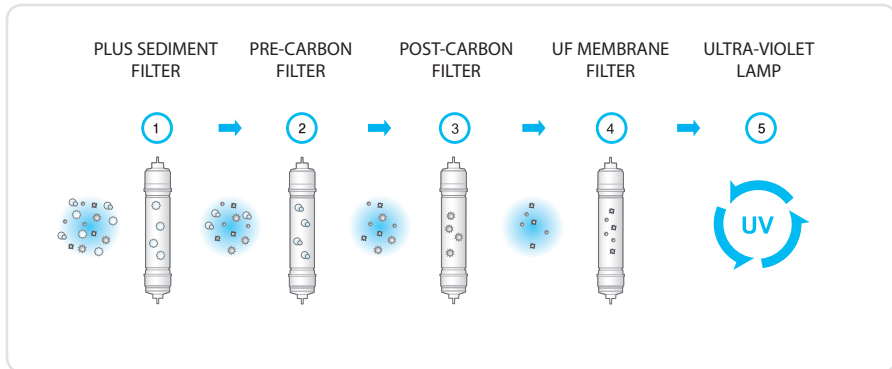

INSTALLATION PRECAUTIONS

■ The summary for the proper installation of the water filtration device ■

1. Close main water supply valve to separate the faucet.

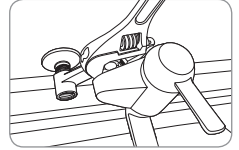

2. Apply the teflon tape on the adaptor and fit it to the pipe.

 Do not turn the water pipe.

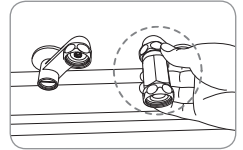

3. Connect the faucet with the adaptor.

 Install the adaptor with connector to the cold water pipe.

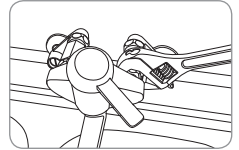

4. Connect 1/4 inch orange tubing with the connector on the adaptor.

 Flush water through each filter at least 5 minutes before Connection.

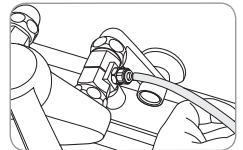

5. Open the feed valve to supply water to the filtration system.

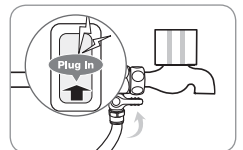

! Please check before use! |

This product is for 120 V~ 60 Hz only.

Please connect the power plug to a grounded electrical outlet for 120 V~ 60 Hz. The water filtration device works normally only when the electricity is connected.

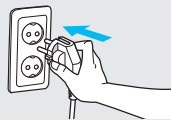

- **Open the main water supply valve.**

The main water must be supplied to operate the water filtration device normally.

- **After installing the product**

Get rid of the saved water above the full water in the inner water tank 2 times or more to use.

- **When the indicator in the indication part is turned off**

When the indicator in the indication part is turned off, check if the power supply was stopped due to the power failure or other cause.

- **Regular filter replacement**

It is important to replace the filter regularly to maintain water quality as it is designed. If the filter is overused beyond its service life, the performance of the water filtration device deteriorate. Do not miss the filter replacement cycle.

- **When you didn't use for a long time**

If you saved the water for a long time or you didn't use, drain the water inside of the water filtration device completely and remove the newly filtered water one time to use.

- **When you don't want to use the product for a long time.**

Close the main water supply valve and unplug the power cord.



Tips

When you don't use for a long time, close the main water supply valve and unplug the power cord.

INDICATORS AND CONTROLS

Indication part/Operation part

- Indicators ■ Controls

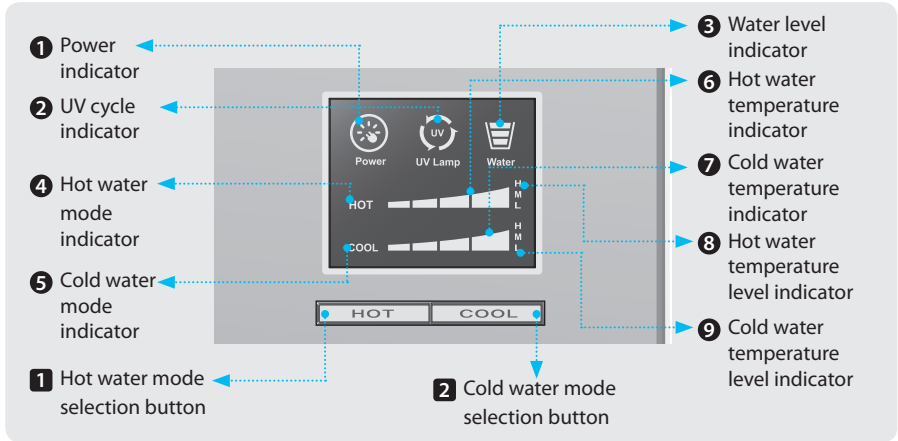

1 Power indicator

If you connect the power, the indicator is turned on.



2 UV cycle indicator

In case that storage tank is full for a hour, "UV" lamp lights on and ☼ lamp lights off in serial. in case that "UV" lamp blinks, change the UV lamp.



3 Water level indicator

The indicator is turned on according to the water level in the storage tank. Basically, one blank is turned on.



4 Hot water mode indicator

When you select hot water mode, the indicator is turned on.



5 Cold water mode indicator

When you select cold water mode, the indicator is turned on.



6 Hot water temperature indicator

The indicator is turned on according to the hot water temperature. The more LEDs are on, the higher the hot water temperature is.



7 Cold water temperature indicator

The indicator is turned on according to the cold water temperature. The more LEDs are on, the lower the cold water temperature is.



8 Hot water temperature level indicator

The indicator is controlled by hot water mode selection button.



9 Cold water temperature level indicator

The indicator is controlled by cold water mode selection button.

HOT

COOL

1 Hot water mode selection button

To select/deselect hot water mode.

2 Cold water mode selection button

To select/deselect cold water mode.

To use cold water mode

Press cold water mode selection button and check if cold water mode indicator is turned on. If you want to turn off cold water mode, press selection button for about 3 seconds or more. In statement of cold water selection, water level is changed in order of H → L → M → H whenever you press the button shortly.

- * When you are using the product for the first time, or if the cold water feature is off for a long time, then it takes about an hour for the water to reach a preset cold water temperature.

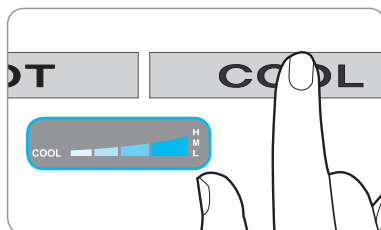

To use hot water mode

Press hot water mode selection button and check if hot water mode indicator is turned on. If you want to turn off hot water mode, press selection button for about 3 seconds or more. In statement of hot water selection, water level is changed in order of H → L → M → H whenever you press the button shortly.

- * When you are using the product for the first time, or if the hot water feature is off for a long time, then it takes about 30 minutes for the water to reach a preset hot water temperature.

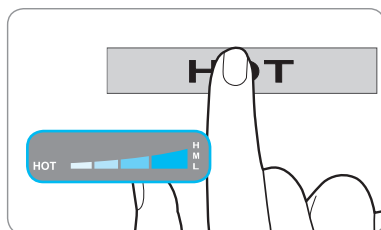

HOW TO USE

■ To drink the cold water ■

You can drink the cold water when you turn the jog shuttle to the left in cold water/room water changeover faucet and pushing the cup-touch lever.

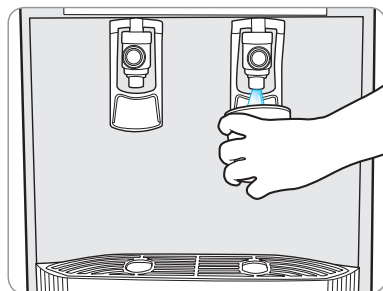
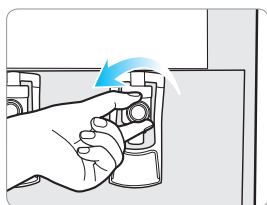

Tips

If the cold water doesn't come from the water filtration device, check if the cold water mode indicator is turned on (See P.16).

■ To drink the hot water ■

If you press the hot water safety button and push the cup-touch lever, you can drink the hot water.

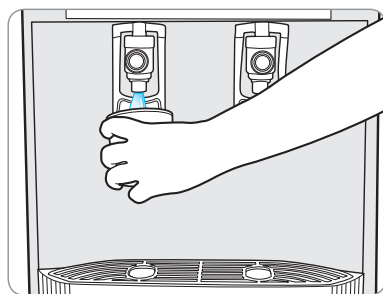
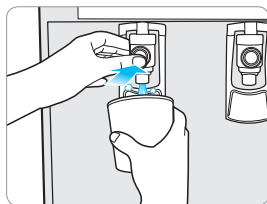

Tips

If the cold water doesn't come from the water filtration device, check if the cold water mode indicator is turned on (See P.16).

■ To drink the room water ■

You can drink the room water when you turn the jog shuttle to the right in cold water/room water changeover faucet and push the cup-touch lever.

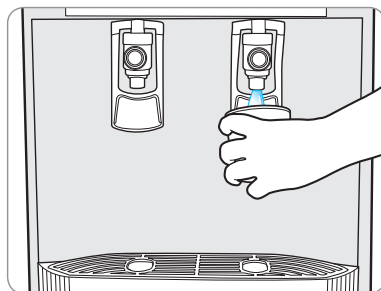
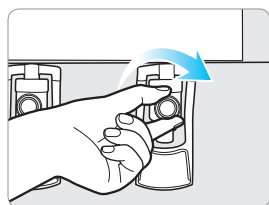

INSTALLATION

Follow the instruction for installation

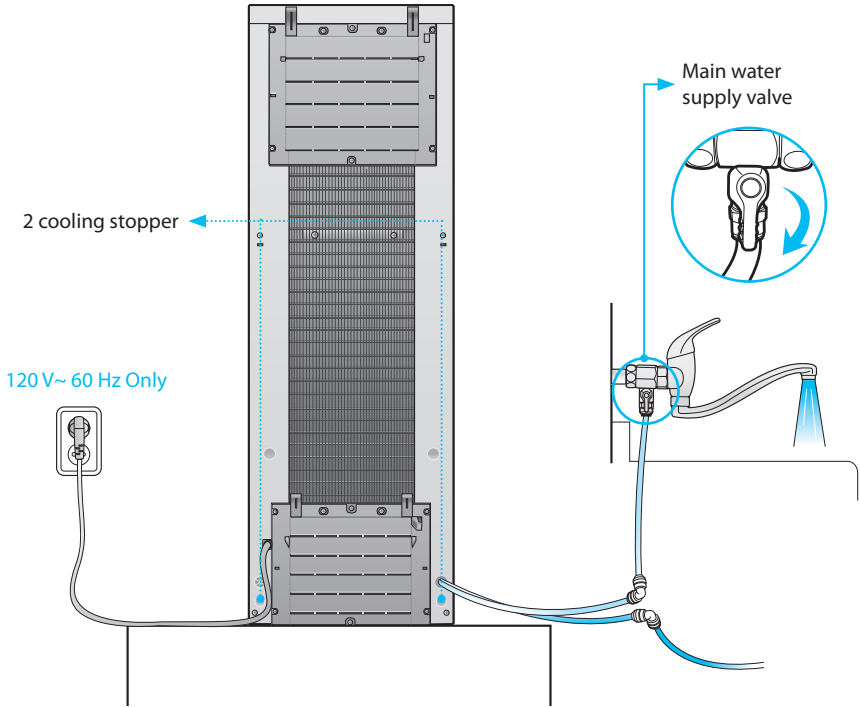

Connect the orange color inlet tubing ① to the tap water supplying pipe. Connect the outlet tubing ②.

Inlet tubing (Orange)

Outlet tubing
(Blue, CHP-04AR/L)

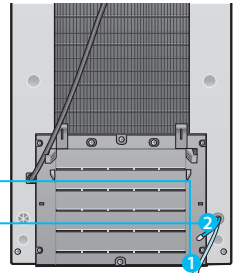

Be cautious!

Water filtration device installation place 1

Please install the water filtration system not at a rough place, a damp place, a place where the unit is exposed to the direct sunlight, a place where dust is present, or a place that the water drops.



Water filtration device installation place 2

Please install at the place where it is 10 cm or more off from the wall and the bottom is flat and firm.

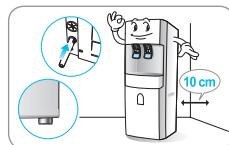

After installing the water filtration system

Please empty the water tank filled with filtered water two times after the product installation.



Cold water plumbing

Please connect the source water. Make sure that the source water is not from hot water line. If you use hot water as source water, then it will cause permanent damages to RO membrane and severely degrade the product performance.

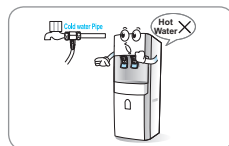

Movement and installation

When the position is moved, connect the power cord when 30 minutes passes after installing.

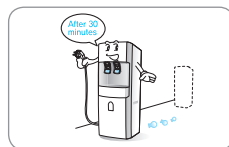

Tips

To maintain optimal product performance, consult a Coway engineer for the detailed installation methods.

- ⚠️ There may be some water remaining inside of the filter which was used to test the product during inspection process at the factory. Please feel at easy and use as it isn't the used product.
- ⚠️ Don't reuse the main water supply valve and hose that was previously used when you re-install the product.

CLEANING METHOD

| Storage tank |

1. Turn off by pressing cold water / hot water mode selection button in the front of the product for 3 seconds or more and unplug. Please lock the main water supply valve.

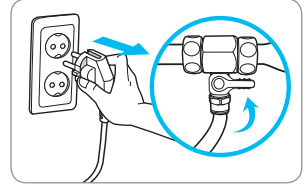

2. Please empty the water tank completely using the draining hose after pressing and letting down the front draining door.

* Drain the water in Cold water/Room water tank from the upper blue cover, and drain the water in Hot water tank from the lower red cover.

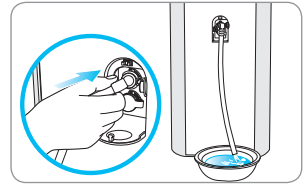

3. Please remove the top cover, and then un-hook the fixed clip holding the top cover of the water tank. Now remove hose and open the tank cover.

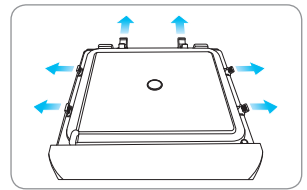
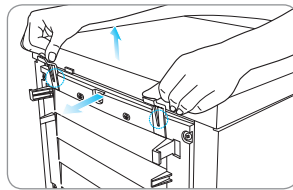

4. Wipe the surface of the storage tank with soft clothes.

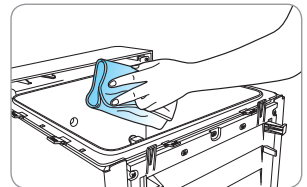

5. Use the storage tank after cleaning it with the drained water, and empty the water tank using the draining hose. After cleaning, please close both tank and top cover, then empty the water tank filled with filtered water one more time.

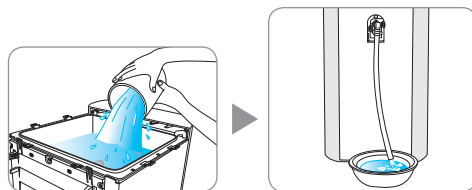

6. Open the main water supply valve after closing the water tank cover, upper cover and plugging the power cord.

Please operate the water filtration device again by pressing cold water / hot water mode selection button in the front of the product after checking if the water is coming from the cold water/the room water extraction faucet and the hot water extraction faucet.

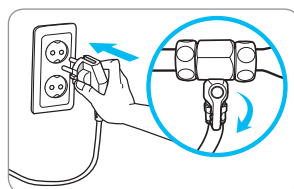

Tips

- ⚠️ **Close the storage tank cover completely.**
Insects or other foreign particles can be entered.

- ⚠️ **When you clean the storage tank, don't use any chemicals or detergent.**

If you don't clean chemicals or detergent cleanly, it can be harmful to the body.

- Keep the surroundings clean and clean the storage tank once per two months.

Drugs,
detergent, etc. X



CLEANING METHOD

| Gutter |

1. Gutter separation method

After leaning the gutter forward and taking in from the product, Separate the gutter cover.

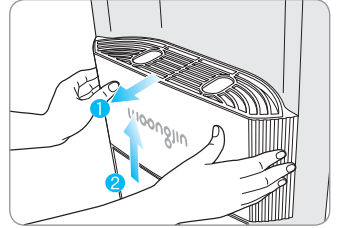

2. Gutter assembling method

After assembling the gutter and the gutter cover, insert the assembled gutter into below the product.

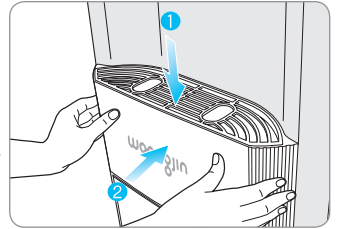
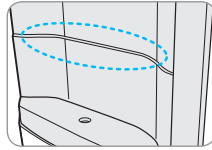

Tips

For the product installed the draining hose, you don't need to empty the gutter additionally.

FILTER REPLACEMENT

■ Filter

Filter is a critical component for a water filtration system. Replacing authorized filters at a specified replacement cycle is important to maintain the water quality, and a proper system operation. Please replace filters at a specified replacement cycle. For replacement filters, please contact Coway authorized dealers and distributors.



■ Filter replacement cycle

If the filter is not regularly replaced, it may degrade the water quality from the product. The source water quality can shorten the filter replacement period.

* The period for the filter exchange is made based on 10 L use in a day for house use(4 people based) and 20 L use for business.

CHP-04AR/L

Part No.	Names of Filter	Replacement Cycle
WJSF14-PLUS	Plus sediment filter	6 months
WJCF14-PRE	Pre-carbon filter	12 months
WJMF14-75	RO Membrane filter(CHP-04AR)	24 months
WJMF14-50	RO Membrane filter(CHP-04AL)	24 months
WJIF14 / WJFCF14-POST	Inno-sense filter / Fine post-carbon filter	18 months
WJUUVF-4W-PUMP	Ultra-violet filter	12 months

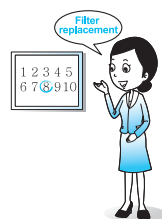

CHP-04AU

Part No.	Names of Filter	Replacement Cycle
WJSF14-PLUS	Plus sediment filter	6 months
WJCF14-PRE	Pre-carbon filter	12 months
WJIF14 / WJCF14-POST	Inno-sense filter / Post-carbon filter	18 months
WJMF14-UF	UF Membrane filter	12 months
WJUUVF-4W-PUMP	Ultra-violet filter	12 months

■ About filter replacement cycle

The filter replacement cycle described above is not the filter quality warranty period but the expected cycle (life) that the filter shows its original performance.

Therefore, the filter replacement cycle may be reduced for the area with the poor water quality or more water consumption.



FILTER REPLACEMENT METHOD

1. Close the main water supply valve after unplugging the power cord, and drain the water inside of the water filtration device (See P.21).

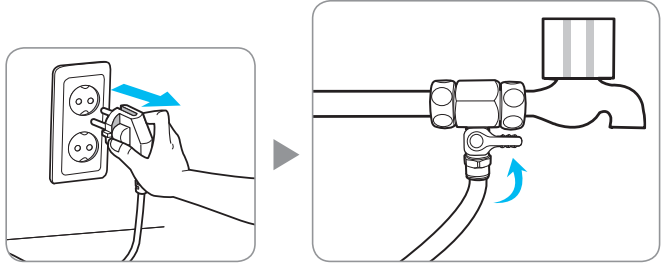

2. Open by pressing the front draining cover and release 1 fixed screw using the Philips driver.
Separate the front cover under the product by pressing and pulling forward.

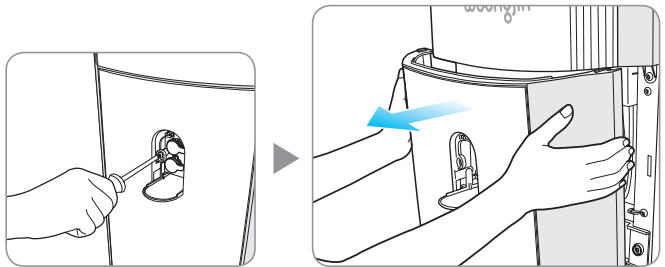

3. After separating the fitting connected to the filter to replace, please replace the filter. (Separate the fitting using the proper tool.)

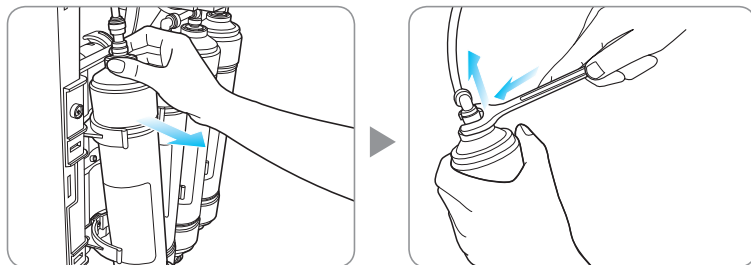

Tips

- ⚠ When you are replacing filters, please make sure that a corresponding filter and a hose are firmly connected and that there is no leakage. It is recommended to empty the water tank filled with the filtered water at least one time right after the filter replacement.

4. Please fit the groove of the front cover. After tightening 1 fixed screw in the front draining part using the Phillips driver, let down and close the front draining door.

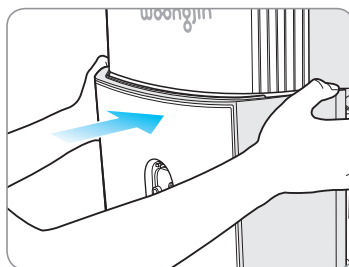

Tips

- ⚠ Before installing a new filter, please do the filter cleansing first as directed below:

Filter Name	Cleansing Time	Comment
Plus sediment filter	30 seconds	
Pre-carbon / Inno-sense / Post carbon / Fine post carbon filter	3 minutes	Please use plus sediment filtered water for cleansing
Ro membrane filter	3 minutes	Please use plus sediment filtered water for cleansing

TROUBLESHOOTING

The water filtration device may operate abnormally due to minor causes not because of the product malfunction but because of the fact that the user is not familiar with the product use. In such a case, problems can be solved easily even without the help from the Service Center by checking the following items. If you can't solve the problem after checking the following items, please call the Service Center.

Symptom	Check	Measures to take
The water tastes weird.	• Did you clean the storage tank?	Clean the storage tank.
	• You didn't use the water filtration device for a long time.	Get rid of the saved water and clean the storage tank.
	• Isn't it about time to change the filter?	Request the filter replacement.
The water doesn't come.	• Is the water supply cut or isn't the water supply valve closed?	Open the main water supply valve.
	• Did you miss the filter replacement times?	Request the filter replacement.
The water is flowing slower.	• Isn't it about time to change the filter?	Request the filter replacement.
	• Is the power connected?	Check if the power cord plug in 120 V~ 60 Hz outlet.
	• Didn't you close the main water supply valve?	Open the main water supply valve.
	• Didn't the temperature of the main water drop suddenly?	If the water temperature is lowered, the water amount is decreased.
The cold water / hot water doesn't come.	• Was the cold water mode indicator lightened?	Please press the cold water mode selection button.
	• Didn't you close the main water supply valve?	If it is the low water level to protect the electric motor, the cooling function doesn't operate. Open the main water supply valve.
	• Isn't the back side of the water filtration device and the wall too close?	Please keep the distance between the back of the water filtration device and the wall to 10 cm or more.
All operation was stopped suddenly when driving.	• Is the main water being supplied actively?	Check the main water supply valve.
	• Is the power connected?	Check if the power cord plug in 120 V~ 60 Hz outlet.
	• Isn't water overflowing or leaking?	Request A/S.

SPECIFICATION

Product		Water Filtration Device		
Model		CHP-04AR	CHP-04AL	CHP-04AU
Filtration Method		RO(Reverse Osmosis)		UF
Power Supply		120 V~ 60 Hz		
Tank Capacity	Room Water	14 L		
	Cold Water	3 L		
	Hot Water	3.6 L		
	Total	22.4 L		
Dimension		380 mm(W) × 437 mm(D) × 1 257 mm(H)		
Working Temperature		5 °C - 35 °C		
Production Rate		284 L/d(25 °C, 414 kPa)	190 L/d(25 °C, 138 kPa)	1 500 L/d(25 °C, 108 kPa)
Working Pressure		69 kPa – 827 kPa	138 kPa – 827 kPa	69 kPa – 827 kPa
Net Weight		38.6 kg	36.5 kg	36.5 kg

- The water amount can be differentiated according to the water pressure and the water temperature.
- The water tank capacity is the amount by the size and can be different from the extraction capacity.
- Without any prior notice, all or parts of the product are subject to change for the purpose of improving the performance of the product.
- Refer to Performance data sheet for individual contaminants, reduction performance and general operating information.

WATER FLOW DIAGRAM

CHP-04AR

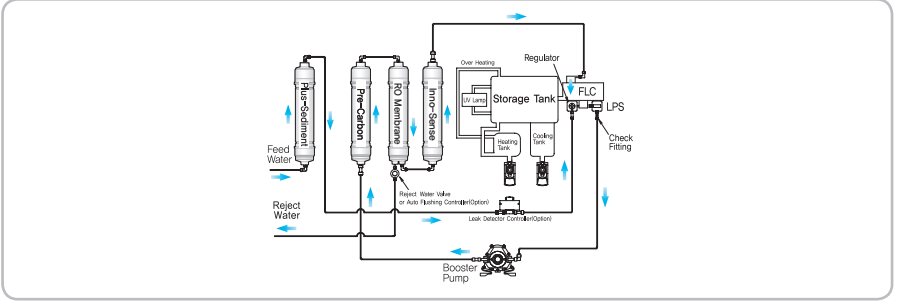

CHP-04AL

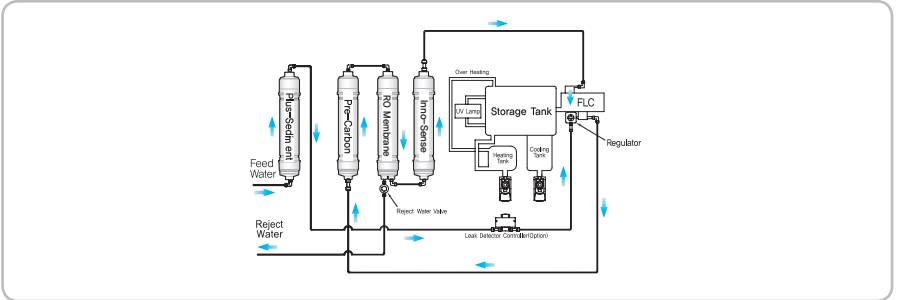

CHP-04AU

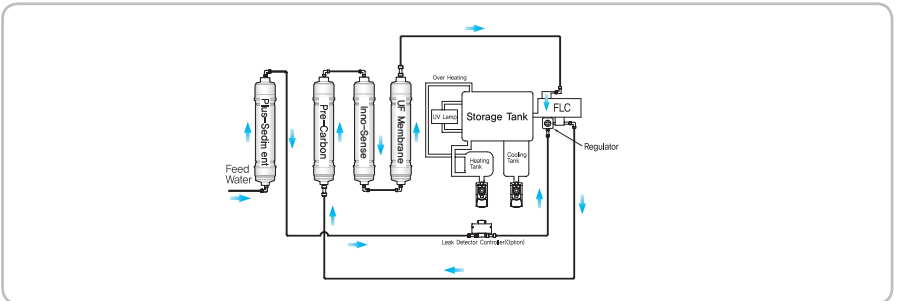

- An fine post carbon filter(post carbon filter) may be installed instead of a inno-sense filter. For the precise specifications of your product, refer to the data plate on the product.

Water Filtration System Performance Data Sheet



Brand: Metro

Model: CHP-04AR

This system has been tested and certified by the Water Quality Association according to NSF/ANSI 42, 53, and 58 for the reduction of the substances listed below. The concentration of the indicated substances in water entering the system was reduced to a concentration less than or equal to the permissible limit for water leaving the system, as specified in NSF/ANSI 42, 53, and 58.

Substance	Max. Allowable Concentration (mg/L)	Average Influent (mg/L)	Average Effluent (mg/L)	Minimum Percent Reduction (%)	Average Percent Reduction (%)
Arsenic (Pentavalent)	0.010	0.05	0.006	79.1	87.7
Barium	2.0	10	1.4	83.5	86.6
Radium 226/228	5pCi/L	25pCi/L	5pCi/L	N/A	N/A
Cadmium	0.005	0.031	0.002	89.0	92.7
Chromium (Hexavalent)	0.1	0.358	0.023	93.8	95.1
Chromium (Trivalent)	0.1	0.367	0.028	93.8	95.7
Lead	0.010	0.153	0.005	93.6	95.1
Nitrate/Nitrite	10	29.6	4.8	78.5	83.7
Selenium	0.05	0.117	0.003	96.0	97.8
TDS	<187.5	741.5	14.5	97.3	98.0
Aesthetic Chlorine					
INNOSENSE	≥ 50%	2.07	0.56	54.53	72.8
FINE POST CARBON	≥ 50%	1.96	0.53	55.0	72.8
VOC*					
INNOSENSE	≥ 95% reduction	0.327	0.0052	96.20	98.4
FINE POST CARBON	≥ 95% reduction	0.317	0.005	96.2	98.5

While testing was performed under laboratory conditions, actual performance may vary.

General Operating Information:

Rated Capacity	INNOSENSE FILTER	359 gallons (for VOC) 7,523 gallons (for Aesthetic Chlorine)
	POST-CARBON FILTER	402 gallons (for VOC) 1,453 gallons (for Aesthetic Chlorine)
Min-Max operating pressure:	10 ~ 120 psi (0.7 ~ 8.4 kgf/cm ²)	
Min-Max feed water temperature:	41 ~ 95 °F (5 ~ 35 °C)	
Rated Service Flow	0.07 GPM (for VOC) 0.5 GPM (for Aesthetic Chlorine)	
Daily Water Production Rate	86.2 GPD	
Product Efficiency Rating	38.7 %	
Electrical Requirements:	120 Vac / 60Hz	

- Do not use with water that is microbiologically unsafe or of unknown quality without adequate disinfection before or after the system.
- Refer to the owners manual for specific installation instructions, manufacturer's limited warranty, user responsibility, and parts and service availability.
- The influent water to the system shall include the following characteristics:
 - No organic solvents
 - Chlorine: < 2 ppm
 - pH: 7 - 8
 - Temperature: 41 ~ 95 °F (5 ~ 35 °C)
 - Iron: < 2 ppm
 - Turbidity: < 1 NTU
 - Hardness: < 1000 mg/L

- For parts and service availability, please contact your local dealer or Coway.
- This system is acceptable for treatment of influent concentrations of no more than 27 mg/L nitrate and 3 mg/L nitrite in combination measured as N and is certified for nitrate/nitrite reduction only for water supplies with a pressure of 2.8 kgf/cm² (40 psi) or greater.
- A nitrate/nitrite sampling kit should be used to monitor the nitrate/nitrite levels in your product drinking water at least every six months. Kits may be purchased from your local dealer or Coway.
- This system has been tested for the treatment of water containing pentavalent arsenic (also known as As(V), As(+5), or arsenate) at concentrations of 0.050 mg/L or less. This system reduces pentavalent arsenic, but may not remove other forms of arsenic. This system is to be used on water supplies containing a detectable free chlorine residual at the system inlet or on water supplies that have been demonstrated to contain only pentavalent arsenic. Treatment with chloramines (combined chlorine) is not sufficient to ensure complete conversion of trivalent arsenic to pentavalent arsenic. Please see the Arsenic Facts section of this Performance Data Sheet for further information.
- Efficiency rating means the percentage of the influent water to the system that is available to the user as reverse osmosis treated water under operating conditions that approximate typical daily usage.
- The product water should be tested every 6 months to ensure that the contaminants are being reduced effectively. Please contact your local dealer or Coway to initiate this service.
- This reverse osmosis system contains a replaceable treatment components, critical for the effective reduction of total dissolved solids and that product water shall be tested periodically to verify that the system is performing properly. Replacement of reverse osmosis component should be with one of identical specifications, as defined by the manufacturer, to assure the same efficiency and contaminant reduction performance.
- The estimated replacement time of filter, which is a consumable part, is not an indication of quality guarantee period, but it means the ideal time of filter replacement. Accordingly, the estimated time of filter replacement may be shortened in case it is used in an area of poor water quality.

Model of Filter	Type	Usable period (months)	COST US \$
WJSF14-PLUS	PLUS SEDIMENT FILTER	6	32.00
WJCF14-PRE	PRE-CARBON FILTER	12	36.00
WJMF14-75	RO MEMBRANE FILTER	24	156.00
WJIF14 /WJFCF14-POST	INNO SENSE FILTER / FINE POST-CARBON FILTER	18	47.00
WJUUV-4W-PUMP	ULTRA-VIOLET LAMP	12	187.00

ARSENIC FACTS

Arsenic (abbreviated As) is found naturally in some well water. Arsenic in water has no color, taste or odor. It must be measured by a lab test. Public water utilities must have their water tested for arsenic. You can get the results from your water utility. If you have your own well, you can have the water tested. The local health department or the state environmental health agency can provide a list of certified labs. The cost is typically \$15 to \$30. Information about arsenic in water can be found on the Internet at the US Environmental Protection Agency website:

www.epa.gov/safewater/arsenic.html

There are two forms of arsenic: pentavalent arsenic (also called As(V), As(+5), and arsenate) and trivalent arsenic (also called As(III), As(+3), and arsenite). In well water, arsenic may be pentavalent, trivalent, or a combination of both. Special sampling procedures are needed for a lab to determine what type and how much of each type of arsenic is in the water. Check with the labs in your area to see if they can provide this type of service. Reverse osmosis (RO) water treatment systems do not remove trivalent arsenic from water very well. RO systems are very effective at removing pentavalent arsenic. A free chlorine residual will rapidly convert trivalent arsenic to pentavalent arsenic. Other water treatment chemicals such as ozone and potassium permanganate will also change trivalent arsenic to pentavalent arsenic. A combined chlorine residual (also called chloramine) may not convert all the trivalent arsenic. If you get your water from a public water utility, contact the utility to find out if free chlorine or combined chlorine is used in the water system.

The CHP-04AR system is designed to remove pentavalent arsenic. It will not convert trivalent arsenic to pentavalent arsenic. The system was tested in a lab. Under those conditions, the system reduced 0.050 mg/L pentavalent arsenic to 0.010 mg/L (ppm) (the USEPA standard for drinking water) or less. The performance of the system may be different at your installation. Have the treated water tested for arsenic to check if the system is working properly. The RO component of the CHP-04AR system must be replaced every 24 months to ensure the system will continue to remove pentavalent arsenic. The component identification and locations where you can purchase the component are listed in the installation/operation manual.

State of California
 Department of Public Health
**Water Treatment Device
 Certificate Number
 08 - 1905**

Date Issued: June 24, 2008

Trademark/Model Designation

Metro CHP-04AR

Replacement Element(s)

WJSF14-PLUS Plus Sediment Filter
 WJCF14-PRE Pre-carbon Filter
 WJMF14-75 RO Membrane Filter
 WJFCF14-POST Post-carbon Filter
 WJUUVF-4W-PUMP UV Bulb

Manufacturer: Woongjin Coway Co LTD

The water treatment device(s) listed on this certificate have met the testing requirements pursuant to Section 116830 of the Health and Safety Code for the following health related contaminants:

Microbiological Contaminants and Turbidity

None

Inorganic/Radiological Contaminants

Arsenic (Pentavalent)¹
 Barium
 Cadmium
 Chromium (Hexavalent)
 Chromium (Trivalent)
 Lead
 Nitrate/Nitrite²
 Radium 226/228
 Selenium

Organic Contaminants

VOCs

Alachlor
 Atrazine
 Benzene
 Carbofuran
 Carbon Tetrachloride
 Chlorobenzene
 Chloropicrin
 2,4-D
 DBCP
 o-Dichlorobenzene
 p-Dichlorobenzene
 1,2-Dichloroethane
 1,1-Dichloroethylene
 cis-1,2-Dichloroethylene
 trans-1,2-Dichloroethylene
 1,2-Dichloropropane
 cis-1,3-Dichloropropylene
 Dinoseb

Endrin
 Ethylbenzene
 EDB
 Haloacetonitriles (HAN)
 Bromochloroacetonitrile
 Dibromoacetonitrile
 Dichloroacetonitrile
 Trichloroacetonitrile
 Haloketones (HK)
 1,1-Dichloro-2-Propanone
 1,1,1-Trichloro-2-Propanone
 Heptachlor
 Heptachlor Epoxide
 Hexachlorobutadiene
 Hexachlorocyclopentadiene
 Lindane
 Methoxychlor
 Pentachlorophenol

Simazine
 Styrene
 1,1,2,2-Tetrachloroethane
 Tetrachloroethylene
 Toluene
 2,4,5-TP (Silvex)
 Tribromoacetic Acid
 1,2,4-Trichlorobenzene
 1,1,1-Trichloroethane
 1,1,2-Trichloroethane
 Trichloroethylene
 Trihalomethanes (THMs)
 Bromodichloromethane
 Bromoform
 Chloroform
 Chlorodibromomethane
 Xylenes

Rated Service Capacity: 359 gal

Rated Service Flow: 0.07 gpm

Do not use with water that is microbiologically unsafe or of unknown quality, without adequate disinfection before or after the system.

¹ Claims for arsenic reduction shall only be made on water supplies maintaining detectable residual free chlorine at the reverse osmosis (RO) system inlet. Water systems using an in-line chlorinator should provide a minimum of 1 minute chlorine contact time before the RO system.

² This system is acceptable for treatment of influent concentrations of no more than 27 mg/L nitrate and 3 mg/L nitrite in combination measured as N and is certified for nitrate/nitrite reduction only for water supplies with a pressure of 280 kPa (40 psig) or greater. A sampling and analysis test kit for nitrate is provided for checking the performance of this system. Frequent analysis is encouraged.

Water Filtration System Performance Data Sheet



Brand: Metro

Model: CHP-04AL

This system has been tested and certified by the Water Quality Association according to NSF/ANSI 42, 53, and 58 for the reduction of the substances listed below. The concentration of the indicated substances in water entering the system was reduced to a concentration less than or equal to the permissible limit for water leaving the system, as specified in NSF/ANSI 42, 53, and 58

Substance	Max. Allowable Concentration (mg/L)	Average Influent (mg/L)	Average Effluent (mg/L)	Minimum Percent Reduction (%)	Average Percent Reduction (%)
Arsenic (Pentavalent)	0.010	0.05	0.006	79.1	87.7
Barium	2.0	10	1.4	83.5	86.6
Radium 226/228	5pCi/L	25pCi/L	5pCi/L	N/A	N/A
Cadmium	0.005	0.031	0.002	89.0	92.7
Chromium (Hexavalent)	0.1	0.358	0.023	93.8	95.1
Chromium (Trivalent)	0.1	0.367	0.028	93.8	95.7
Lead	0.010	0.153	0.005	93.6	95.1
Nitrate/Nitrite	10	29.6	4.8	78.5	83.7
Selenium	0.05	0.117	0.003	96.0	97.8
TDS	<187.5	741.5	55.1	90.0	92.6
Aesthetic Chlorine					
INNOSENSE	≥ 50%	2.07	0.56	54.53	72.8
FINE POST CARBON	≥ 50%	1.96	0.53	55.0	72.8
VOC*					
INNOSENSE	≥ 95% reduction	0.327	0.0052	96.20	98.4
FINE POST CARBON	≥ 95% reduction	0.317	0.005	96.2	98.5

While testing was performed under laboratory conditions, actual performance may vary.

General Operating Information:

Rated Capacity	INNOSENSE FILTER	359 gallons (for VOC) 7,523 gallons (for Aesthetic Chlorine)
	FINE POST-CARBON	402 gallons (for VOC) 1,453 gallons (for Aesthetic Chlorine)
Min-Max operating pressure:	20 ~ 120 psi (14 ~ 8.4 kgf/cm ²)	
Min-Max feed water temperature:	41 ~ 95 °F (5 ~ 35 °C)	
Rated Service Flow	0.07 GPM (for VOC) 0.5 GPM (for Aesthetic Chlorine)	
Daily Water Production Rate	53.3 GPD	
Product Efficiency Rating	31.0 %	
Electrical Requirements:	120 Vac / 60Hz	

- Do not use with water that is microbiologically unsafe or of unknown quality without adequate disinfection before or after the system.
- Refer to the owners manual for specific installation instructions, manufacturer's limited warranty, user responsibility, and parts and service availability.
- The influent water to the system shall include the following characteristics:
 - No organic solvents
 - Chlorine: < 2 ppm
 - pH: 7 - 8
 - Temperature: 41 ~ 95 °F (5 ~ 35 °C)
 - Iron: < 2 ppm
 - Turbidity: < 1 NTU
 - Hardness: < 1000 mg/L

- For parts and service availability, please contact your local dealer or Coway.
- This system is acceptable for treatment of influent concentrations of no more than 27 mg/L nitrate and 3 mg/L nitrite in combination measured as N and is certified for nitrate/nitrite reduction only for water supplies with a pressure of 2.8 kgf/cm² (40 psi) or greater.
- A nitrate/nitrite sampling kit should be used to monitor the nitrate/nitrite levels in your product drinking water at least every six months. Kits maybe purchased from your local dealer or Coway.
- This system has been tested for the treatment of water containing pentavalent arsenic (also know as As(V), As(+5), or arsenate) at concentrations of 0.050 mg/L or less. This system reduces pentavalent arsenic, but may not remove other forms of arsenic. This system is to be used on water supplies containing a detectable free chlorine residual at the system inlet or on water supplies that have been demonstrated to contain only pentavalent arsenic. Treatment with chloramines (combined chlorine) is not sufficient to ensure complete conversion of trivalent arsenic to pentavalent arsenic. Please see the Arsenic Facts section of this Performance Data Sheet for further information.
- Efficiency rating means the percentage of the influent water to the system that is available to the user as reverse osmosis treated water under operating conditions that approximate typical daily usage.
- The product water should be tested every 6 months to ensure that the contaminants are being reduced effectively. Please contact your local dealer or Coway to initiate this service.
- This reverse osmosis system contains a replaceable treatment components, critical for the effective reduction of total dissolved solids and that product water shall be tested periodically to verify that the system is performing properly. Replacement of reverse osmosis component should be with one of identical specifications, as defined by the manufacturer, to assure the same efficiency and contaminant reduction performance.
- The estimated replacement time of filter, which is a consumable part, is not an indication of quality guarantee period, but it means the ideal time of filter replacement. Accordingly, the estimated time of filter replacement may be shortened in case it is used in an area of poor water quality.

Model of Filter	Type	Usable period (months)	COST US \$
WJSF14-PLUS	PLUS SEDIMENT FILTER	6	32.00
WJCF14-PRE	PRE-CARBON FILTER	12	36.00
WJMF14-50	RO MEMBRANE FILTER	24	145.00
WJIF14 /WJFCF14-POST	INNO SENSE FILTER / FINE POST-CARBON FILTER	18	47.00
WJUVF-4W-PUMP	ULTRA-VIOLET LAMP	12	187.00

ARSENIC FACTS

Arsenic (abbreviated As) is found naturally in some well water. Arsenic in water has no color, taste or odor. It must be measured by a lab test. Public water utilities must have their water tested for arsenic. You can get the results from your water utility. If you have your own well, you can have the water tested. The local health department or the state environmental health agency can provide a list of certified labs. The cost is typically \$15 to \$30. Information about arsenic in water can be found on the Internet at the US Environmental Protection Agency website:

www.epa.gov/safewater/arsenic.html

There are two forms of arsenic: pentavalent arsenic (also called As(V), As(+5), and arsenate) and trivalent arsenic (also called As(III), As(+3), and arsenite). In well water, arsenic may be pentavalent, trivalent, or a combination of both. Special sampling procedures are needed for a lab to determine what type and how much of each type of arsenic is in the water. Check with the labs in your area to see if they can provide this type of service.

Reverse osmosis (RO) water treatment systems do not remove trivalent arsenic from water very well. RO systems are very effective at removing pentavalent arsenic. A free chlorine residual will rapidly convert trivalent arsenic to pentavalent arsenic. Other water treatment chemicals such as ozone and potassium permanganate will also change trivalent arsenic to pentavalent arsenic. A combined chlorine residual (also called chloramine) may not convert all the trivalent arsenic. If you get your water from a public water utility, contact the utility to find out if free chlorine or combined chlorine is used in the water system.

The CHP-04AL system is designed to remove pentavalent arsenic. It will not convert trivalent arsenic to pentavalent arsenic. The system was tested in a lab. Under those conditions, the system reduced 0.050 mg/L pentavalent arsenic to 0.010 mg/L (ppm) (the USEPA standard for drinking water) or less. The performance of the system may be different at your installation. Have the treated water tested for arsenic to check if the system is working properly. The RO component of the CHP-04AL system must be replaced every 24 months to ensure the system will continue to remove pentavalent arsenic. The component identification and locations where you can purchase the component are listed in the installation/operation manual.

State of California
 Department of Public Health
**Water Treatment Device
 Certificate Number
 08 - 1904**

Date Issued: June 24, 2008

Trademark/Model Designation

Metro CHP-04AL

Replacement Element(s)

WJSF14-PLUS Plus Sediment Filter
 WJCF14-PRE Pre-carbon Filter
 WJMF14-50 RO Membrane Filter
 WJFCF14-POST Post-carbon Filter
 WJUUVF-4W-PUMP UV Bulb

Manufacturer: Woongjin Coway Co LTD

The water treatment device(s) listed on this certificate have met the testing requirements pursuant to Section 116830 of the Health and Safety Code for the following health related contaminants:

Microbiological Contaminants and Turbidity

None

Inorganic/Radiological Contaminants

Arsenic (Pentavalent)1
 Barium
 Cadmium
 Chromium (Hexavalent)
 Chromium (Trivalent)
 Lead
 Nitrate/Nitrite2
 Radium 226/228
 Selenium

Organic Contaminants

VOCS

Alachlor
 Atrazine
 Benzene
 Carbofuran
 Carbon Tetrachloride
 Chlorobenzene
 Chloropicrin
 2,4-D
 DBCP
 o-Dichlorobenzene
 p-Dichlorobenzene
 1,2-Dichloroethane
 1,1-Dichloroethylene
 cis-1,2-Dichloroethylene
 trans-1,2-Dichloroethylene
 1,2-Dichloropropane
 cis-1,3-Dichloropropylene
 Dinoseb

Endrin
 Ethylbenzene
 EDB
 Haloacetonitriles (HAN)
 Bromochloroacetonitrile
 Dibromoacetonitrile
 Dichloroacetonitrile
 Trichloroacetonitrile
 Haloketones (HK)
 1,1-Dichloro-2-Propanone
 1,1,1-Trichloro-2-Propanone
 Heptachlor
 Heptachlor Epoxide
 Hexachlorobutadiene
 Hexachlorocyclopentadiene
 Lindane
 Methoxychlor
 Pentachlorophenol

Simazine
 Styrene
 1,1,2,2-Tetrachloroethane
 Tetrachloroethylene
 Toluene
 2,4,5-TP (Silvex)
 Tribromoacetic Acid
 1,2,4-Trichlorobenzene
 1,1,1-Trichloroethane
 1,1,2-Trichloroethane
 Trichloroethylene
 Trihalomethanes (THMs)
 Bromodichloromethane
 Bromoform
 Chloroform
 Chlorodibromomethane
 Xylenes

Rated Service Capacity: 359 gal

Rated Service Flow: 0.07 gpm

Do not use with water that is microbiologically unsafe or of unknown quality, without adequate disinfection before or after the system.

¹ Claims for arsenic reduction shall only be made on water supplies maintaining detectable residual free chlorine at the reverse osmosis (RO) system inlet. Water systems using an in-line chlorinator should provide a minimum of 1 minute chlorine contact time before the RO system.

² This system is acceptable for treatment of influent concentrations of no more than 27 mg/L nitrate and 3 mg/L nitrite in combination measured as N and is certified for nitrate/nitrite reduction only for water supplies with a pressure of 280 kPa (40 psig) or greater. A sampling and analysis test kit for nitrate is provided for checking the performance of this system. Frequent analysis is encouraged.

Water Filtration System Performance Data Sheet



Brand: Metro

Model: CHP-04AU

This system has been tested and certified by the Water Quality Association according to NSF/ANSI 42, and 53 for the reduction of the substances listed below. The concentration of the indicated substances in water entering the system was reduced to a concentration less than or equal to the permissible limit for water leaving the system, as specified in NSF/ANSI 42 and 53

Substance	Max. Allowable Concentration (mg/L)	Average Influent (mg/L)	Average Effluent (mg/L)	Minimum Percent Reduction (%)	Average Percent Reduction (%)
Aesthetic Chlorine					
INNOSENSE	≥ 50%	2.07	0.56	54.53	72.8
POST CARBON	≥ 50%	1.96	0.53	55.0	72.8
VOC*					
INNOSENSE	≥ 95% reduction	0.327	0.0052	96.20	98.4
POST CARBON	≥ 95% reduction	0.317	0.005	96.2	98.5

While testing was performed under laboratory conditions, actual performance may vary.

General Operating Information:

Rated Capacity	INNO SENSE FILTER	359 gallons (for VOC) 7,523 gallons (for Aesthetic Chlorine)
	POST-CARBON FILTER	402 gallons (for VOC) 1,453 gallons (for Aesthetic Chlorine)
Min-Max operating pressure:	10 ~ 120 psi (0.7 ~ 8.4 kgf/cm ²)	
Min-Max feed water temperature:	41 ~ 95 °F (5 ~ 35 °C)	
Rated Service Flow	0.07 GPM (for VOC) 0.5 GPM (for Aesthetic Chlorine)	
Electrical Requirements:	120 Vac / 60Hz	

- Do not use with water that is microbiologically unsafe or of unknown quality without adequate disinfection before or after the system.
- Refer to the owners manual for specific installation instructions, manufacturer's limited warranty, user responsibility, and parts and service availability.
- For parts and service availability, please contact your local dealer or Coway.

Model of Filter	Type	Usable period (months)	COST US \$
WJSF14-PLUS	PLUS SEDIMENT FILTER	6	32.00
WJCF14-PRE	PRE-CARBON FILTER	12	36.00
WJIF14 / WJCF14-POST	INNO SENSE FILTER / POST-CARBON FILTER	18	47.00
WJMF14-UF	UF MEMBRANE FILTER	12	59.00
WJUUV-4W-PUMP	ULTRA-VIOLET LAMP	12	187.00

* VOC Surrogate Claims

Chemical	Drinking water regulatory level ¹ (MCL/MAC) mg/L	Influent challenge concentration ² mg/L	Chemical reduction percent	Maximum product water concentration mg/L
alachlor	0.002	0.050	> 98	0.001 ³
atrazine	0.003	0.100	> 97	0.003 ³
benzene	0.005	0.081	> 99	0.001 ³
carbofuran	0.04	0.190	> 99	0.001 ³
carbon tetrachloride	0.005	0.078	98	0.0018 ⁴
chlorobenzene	0.1	0.077	> 99	0.001 ³
chloropicrin	-	0.015	99	0.0002 ³
2,4-D	0.07	0.110	98	0.0017 ⁴
dibromochloropropane(DBCP)	0.0002	0.052	> 99	0.00002 ³
o-dichlorobenzene	0.6	0.080	> 99	0.001 ³
p-dichlorobenzene	0.075	0.040	> 98	0.001 ³
1,2-dichloroethane	0.005	0.088	95 ⁵	0.0048 ⁵
1,1-dichloroethylene	0.007	0.083	> 99	0.001 ³
cis-1,2-dichloroethylene	0.07	0.170	> 99	0.0005 ³
trans-1,2-dichloroethylene	0.1	0.086	> 99	0.001 ³
1,2-dichloropropane	0.005	0.080	> 99	0.001 ³
cis-1,3-dichloropropylene	-	0.079	> 99	0.001 ³
dinoseb	0.007	0.170	99	0.0002 ⁴
endrin	0.002	0.053	99	0.00059 ⁴
ethylbenzene	0.7	0.088	> 99	0.001 ³
ethylene dibromide (EDB)	0.00005	0.044	> 99	0.00002 ³
haloacetonitriles (HAN):				
bromochloroacetonitrile	-	0.022	98	0.0005 ³
dibromoacetonitrile	-	0.024	98	0.0006 ³
dichloroacetonitrile	-	0.0096	98	0.0002 ³
trichloroacetonitrile	-	0.015	98	0.0003 ³
haloketones (HK):				
1,1-dichloro-2-propanone	-	0.0072	99	0.0001 ³
1,1,1-trichloro-2-propanone	-	0.0082	96	0.0003 ³
heptachlor (H-34,Heptox)	0.0004	0.08	> 99	0.0004
heptachlor epoxide	0.0002	0.0107 ⁵	98	0.0002 ⁶
hexachlorobutadiene	-	0.044	> 98	0.001 ³
hexachlorocyclopentadiene	0.05	0.060	> 99	0.000002 ³
lindane	0.0002	0.055	> 99	0.00001 ³
methoxychlor	0.04	0.050	> 99	0.0001 ³
pentachlorophenol	0.001	0.096	> 99	0.001 ³
simazine	0.004	0.120	> 97	0.004 ³
styrene	0.1	0.150	> 99	0.0005 ³
1,1,2,2-tetrachloroethane	-	0.081	> 99	0.001 ³
tetrachloroethylene	0.005	0.081	> 99	0.001 ³
toluene	1	0.078	> 99	0.001 ³
2,4,5-TP (silvex)	0.05	0.270	99	0.0016 ⁴
tribromoacetic acid	-	0.042	> 98	0.001 ³
1,2,4-trichlorobenzene	0.07	0.160	> 99	0.0005 ³
1,1,1-trichloroethane	0.2	0.084	95	0.0046 ⁴
1,1,2-trichloroethane	0.005	0.150	> 99	0.0005 ³
trichloroethylene	0.005	0.180	> 99	0.0010 ³
trihalomethanes (includes):				
chloroform (surrogate chemical)				
bromoform				
bromodichloromethane	0.080	0.300	95	0.015
chlorodibromomethane				
xylene (total)	10	0.070	> 99	0.001 ³

1. These harmonized values were agreed upon by representatives of USEPA and Health Canada for the purpose of evaluating products to the requirements of this Standard.
2. Influent challenge levels are average influent concentrations determined in surrogate qualification testing.
3. Maximum product water level was not observed but was set at the detection limit of the analysis.
4. Maximum product water level is set at a value determined in surrogate qualification testing.
5. Chemical reduction percent and maximum product water level calculated at chloroform 95% breakthrough point as determined in surrogate qualification testing.
6. The surrogate test results for heptachlor epoxide demonstrated a 98% reduction. These data were used to calculate an upperoccurrence concentration which would produce a maximum product water level at the MCL.

Woongjin Coway, Ltd.
658, Yugu-Ri, Yugu Eub, Gongju-Si, Choongchungnam-Do, Korea
Tel.: 82-41-850-7879 Fax.: 82-41-841-7816

MEMO



MEMO

MEMO



**WARRANTY CARD OR WARRANTY LETTER
ONE YEAR LIMITED WARRANTY
WATER FILTRATION DEVICE CHP-04AR/L/U (“PRODUCT”)**

Model:

Serial Number:

Customer Name:

(“OWNER”)

Date of Purchase:

What This Warranty Covers:

Commencing with the date of purchase of the Product and continuing for a period of one year, if manufacturing defects in the Product cause the Product to not operate properly for its intended use, then subject to the exclusions, conditions, and limitations contained herein, COWAY at its sole option will repair or replace the Product.

Decisions as to the extent of repair or replacement required will be made solely by COWAY.

The remedy under this Warranty is available only for that portion of the Product exhibiting defects at the time of the warranty claim. The replacement Product as well as any remaining original Product will be warranted only for the original one year warranty period. This limited warranty applies only to Product used for an application specified by COWAY for the Product and applied in strict accordance with COWAY published specifications in effect at the time of application. IF PRODUCT IS USED FOR OTHER THAN ITS INTENDED PURPOSE, IT IS SOLD AS IS AND WITHOUT ANY EXPRESS OR IMPLIED WARRANTIES, INCLUDING OF MERCHANTABILITY OR FITNESS FOR A PARTICULAR PURPOSE.

What This Warranty Does Not Cover:

This Warranty warrants that the Product will be free from manufacturing defects which affect the ability of the Product to operate for its intended use; it is not a warranty that the Product will never require repairs or to undertake responsibilities, liabilities or obligations other than those specifically identified in the preceding section. COWAY is not responsible or liable for personal injury or property damage of any kind, even if arising from a breach of this Warranty.

Limitations and Exclusions:

TO THE EXTENT PERMITTED BY APPLICABLE LAW, COWAY DISCLAIMS ANY OTHER WARRANTY EXPRESS OR IMPLIED, THAN THAT PROVIDED FOR HEREIN. THIS WARRANTY IS IN LIEU OF AND EXCLUDES ALL OTHER WARRANTIES, GUARANTEES, CONDITIONS AND REPRESENTATIONS, EXPRESS OR IMPLIED, ORAL OR WRITTEN, STATUTORY OR OTHERWISE, INCLUDING BUT NOT LIMITED TO ANY IMPLIED CONDITIONS OR WARRANTIES AS TO THE MERCHANTABILITY OR FITNESS FOR A PARTICULAR PURPOSE OF THE COWAY PRODUCT. SOME STATES DO NOT ALLOW LIMITATIONS ON HOW LONG AN IMPLIED WARRANTY LASTS, SO THE ABOVE LIMITATION MAY NOT APPLY TO YOU. COWAY DOES NOT AUTHORIZE ANY PERSON INCLUDING ITS REPRESENTATIVES, TO MAKE ANY REPRESENTATION OR TO OFFER ANY WARRANTY, CONDITION OR GUARANTY IN RESPECT OF THE PRODUCT OTHER THAN THIS WARRANTY. THIS LIMITED WARRANTY SHALL BE THE OWNER'S SOLE AND EXCLUSIVE REMEDY AGAINST COWAY AND COWAY SHALL NOT BE LIABLE FOR ANY CONSEQUENTIAL, EXEMPLARY, SPECIAL, INCIDENTAL OR OTHER DAMAGES INCLUDING, BUT NOT LIMITED TO, LOSS OF PROFITS, AND LOSS OF USE. INCIDENTAL, CONSEQUENTIAL AND EXEMPLARY DAMAGES SHALL NOT BE RECOVERABLE EVEN IF THE REMEDIES OR THE ACTIONS PROVIDED FOR IN THIS WARRANTY FAIL OF THEIR ESSENTIAL PURPOSE. SOME STATES DO NOT ALLOW THE EXCLUSION OR LIMITATION OF INCIDENTAL OR CONSEQUENTIAL DAMAGES, SO THE ABOVE LIMITATION OR EXCLUSION MAY NOT APPLY TO YOU. COWAY SHALL NOT BE LIABLE FOR ANY DAMAGES WHICH ARE BASED UPON NEGLIGENCE, BREACH OF WARRANTY, STRICT LIABILITY OR ANY OTHER LEGAL THEORY OF LIABILITY OTHER THAN THE EXCLUSIVE LIABILITY SET FORTH IN THIS WARRANTY

Limitations on Implied Warranties:

Any implied warranty of merchantability or fitness for a particular purpose or use, shall be limited to the duration of the foregoing express written warranty.

Conditions of Warranty:

COWAY's continuing liability under this Warranty is conditioned upon the following :

- a) The defect or damage is not caused by or is the result of : abnormal use or conditions; improper storage, unauthorized modifications or repair; misuse, neglect, accident, alteration, improper installation or other acts that are not the fault of Coway or the manufacturer of the product or that are not covered by the manufacturer's warranty;
- b) The Product has not been altered, modified or repaired without prior written approval of COWAY;
- c) The OWNER has notified COWAY in writing of any failure of the Product covered by this Warranty within thirty (30) days following such failure;
- d) There has been no misuse, abuse or negligence with respect to the Product on the part of the OWNER.

Waiver:

COWAY's failure at any time to enforce or rely upon any of the terms or conditions stated herein shall not be construed to be a waiver of its rights hereunder.

Obtaining Warranty Service and OWNER'S Duties:

If the Product fails to operate for its intended purpose, then notify Coway or its Representative Agency within 48 hours or within the next business day after discovery of any defect in the Product. The OWNER must give written notice to COWAY no later than thirty (30) days after a defect is discovered or should by reasonable diligence have been discovered. Claims under this Warranty will require proof of purchase by the OWNER.

USA

Add :	WOONGJIN COWAY USA, INC. 695 SOUTH VERMONT, STE. 110(SOUTH TOWER) LOS ANGELES, CA 90005, USA
Call Center :	(213) 386-9900 / (213) 480-1600
FAX :	(213) 386-3990

