

OPERATING INSTRUCTIONS
AND PARTS LIST FOR
Craftsman Bench Saw
10-Inch Tilting Arbor

Model Number

113.27521

The above Model Number will be found on a plate attached to your saw, at the back, near the bottom of the base. Always mention the Model Number when communicating with us regarding your saw or when ordering parts.

Instructions for Ordering Parts

All parts listed herein must be ordered through a Sears retail store or mail order house. Parts are shipped prepaid. When ordering repair parts, always give the following information:

1. The part number.
2. The part name.
3. The model number.

This list is valuable. It will assure your being able to obtain proper parts service. We suggest you keep it with other valuable papers.

SEARS, ROEBUCK AND CO.
AND SIMPSONS-SEARS LIMITED

Printed in U. S. A.

Instructions for Assembling and Operating Your Saw

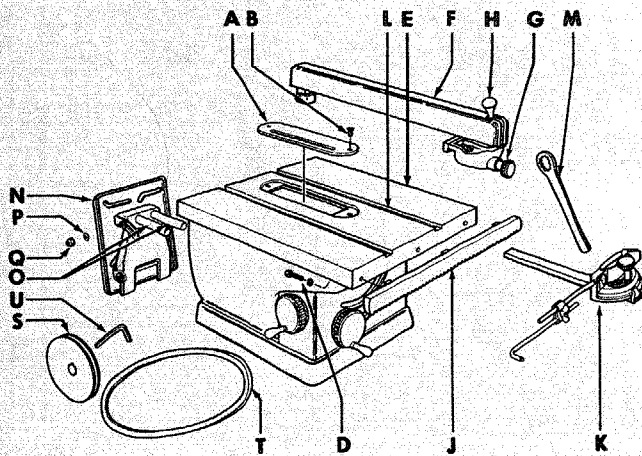

Figure 1

UNCRATING

Your Craftsman Saw is shipped complete (without motor) in one crate. To open crate, remove lid and unfold sides — then unbolt saw from wood base. Before discarding packing material, examine it carefully for loose parts.

ASSEMBLING -- ADJUSTING

Your saw is shipped with the following loose parts wrapped separately and packed in same crate with the saw (see figure 1): Rip fence rack (J), three screws and lock washers (D), rip fence (F), miter gage (K), motor mount (N), motor pulley (S), V-belt (T), arbor nut wrench (M), and Allen wrench (U). Thoroughly clean the saw and these loose parts with a dry cloth. Remove the rust-preventive coating on the saw table by wiping it off with a cloth soaked in kerosene.

NOTICE

The saw guard assembly (Part 9-2791 Fig. 4) is not furnished with the saw. The above assembly may be ordered through any Sears Retail Store or Mail Order House under Catalog No. 9-2791.

Before attempting to use your saw, assemble the parts as instructed below — and be sure to make all of the checks and adjustments given in these instructions. This is important! Even though all adjustments are carefully checked before saw is shipped, rough handling in transit may make some readjustments necessary. Unless saw is maintained in proper adjustment throughout, you cannot do the fast, accurate work for which it is designed.

CHECK ARBOR NUT — Remove two screws (B, fig. 1) and lift out the insert (A, fig. 1). Check tightness of saw arbor nut (part 6362, fig. 5), using wrench (M, fig. 1). Replace insert and screws.

ALIGN SAW BLADE WITH TABLE GROOVES — Using elevation hand wheel (A, fig. 2), set saw blade for deepest cut. Make pencil mark on tooth that is just above table top at front of blade. Measure distance from this tooth point to right-hand table groove (L, fig. 1). Rotate blade by hand to place this same tooth just above table top at rear — then again measure distance from tooth point to right-hand groove. The two measurements must be exactly equal. If not, loosen the three screws (part S-860, fig. 4) in each trunnion which secure the table trunnion (part 13, fig. 4) to the table. Shift the two trunnions until the two measurements are equal, then retighten the screws. Again check measurement.

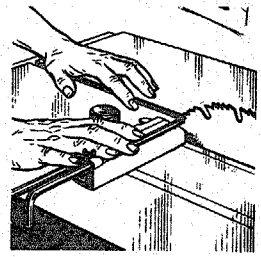

INSTALL RIP FENCE — Secure the rack (J, fig. 1) to the front skirt of the saw table, using the three screws and lock washers (D, fig. 1). Be sure to position rack with gear teeth facing downward — and with top edge of rack parallel with the top of table. Pull the rip fence knob (G, fig. 1) out to permit the guide of the rip fence (F, fig. 1) to slide over rack (J, fig. 1) — then place the rip fence on the saw table as shown in figure 2. A slight pressure must be exerted on the rip fence to cause it to seat properly on the rack. This is necessary because there are two bar alignment springs which act on the inner lip of the rack to hold the fence in continuous alignment. Slide fence along rack, noting clearance between fence and table top. If any part of the fence (other than the sliding pad at the rear) drags on the table top, or if the clearance between fence and table varies appreciably as fence is moved, rack (J, fig. 1) must then be readjusted. This can be done by again loosening screws (D, fig. 1) to reposition the rack.

ADJUSTING RIP FENCE PARALLEL TO SAW BLADE — Place the rip fence next to the right-hand table groove (L, fig. 1) and clamp it in place by pushing down on the cam clamp lever (H, fig. 1). Fence should be perfectly parallel to the groove. If not, loosen the four screws (parts S-1264 and S-1265, fig. 4) which secure the guide to the fence. Align fence with groove — then retighten screws.

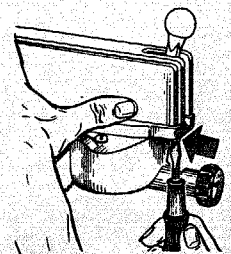

MOUNTING THE MOTOR — Mount the motor (see Motor Specifications) to the motor mount assembly (N, fig. 1) — then mount the motor support assembly to the saw by sliding the two pins (O, fig. 1) into the mounting holes at the rear of the cradle. Place pulley (S, fig. 1) on the motor shaft, line it up with the pulley on the saw arbor, then tighten the pulley set screws. Install V-belt (T, fig. 1) over pulleys and adjust the belt tension by

moving the motor support assembly towards or away from the cradle. Motor should be allowed to rest or hang against the belt to obtain the automatic belt tightening feature — and belt should be snug. If adjustment is correct, clamp the motor support in place by tightening the two square head set screws (part S-1267, fig. 4).

ADJUSTING MOTOR MOUNT TENSION. Tension is adjusted by tightening the nut (part S-1215, fig. 4) against the steel washer (part S-1261) and the spring washer (part 6423). Nut should be tightened just enough to reduce motor vibration when saw is operating. Do NOT tighten nut to a locked position, or the stud will be sheared off when blade is raised or lowered. A sliding action is necessary because mount changes position as blade is raised or lowered. Operate the saw by hand to make certain that the belt has proper tension and that mount changes position as it should.

If saw is to be driven by a large frame motor that cannot be mounted on the motor support assembly, mount the motor on motor rails. Use a 1/2-inch wide belt with a minimum length of 80 inches. Adjust the position of the motor until belt clears all obstructions through all positions of the saw blade.

If saw is to be driven from a line shaft, use a belt at least 100 inches long.

PLACEMENT OF MITER GAGE — The miter gage assembly (K, fig. 1) can be used in either one of the two table grooves.

MOTOR SPECIFICATIONS

This saw is designed to be used with a 3450 rpm motor. Motor should be 3/4 hp (for light duty) or one hp (for heavy duty) — in either an AC motor of a repulsion-induction or capacitor type, or a compound-wound DC. The motor shaft center should be approximately 4 inches above the bottom of the motor base. If this dimension varies appreciably from 4 inches, it may be necessary to obtain a belt of a different length. If a 1750 rpm motor with a 4-5/8-inch shaft center height is used, a 5-inch motor pulley and a 46-inch belt must be purchased. If the motor shaft center height varies greater or smaller than the above dimension, a correspondingly greater or smaller belt length should be used. These may be ordered through any Sears Retail Store or Mail Order House.

CAUTION

Under no circumstances should a 5-inch motor pulley be used with a 3450 rpm motor. The saw blade speed resulting from such a pulley ratio would be dangerous. Do not use a 2 1/2-inch motor pulley with a 1750 rpm motor — this will not give satisfactory saw performance.

OPERATING CONTROLS

The following controls should be tested until the operator is thoroughly familiar with their uses. See figure 2.

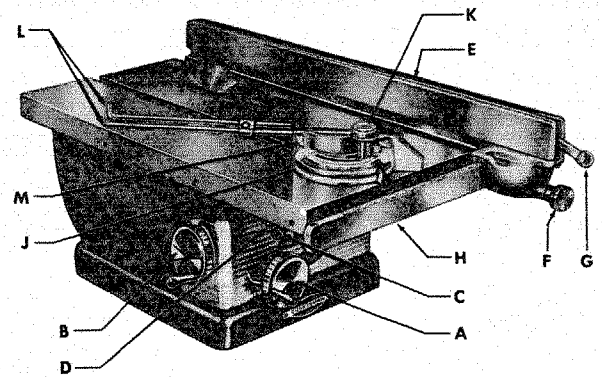

Figure 2

ELEVATION HAND WHEEL (A) — on the front of the saw, controls elevation of the blade.

CLAMP SCREW HANDLE (D) — on front of saw, locks the tilt mechanism in any desired position. The clamp screw handle operates like a socket wrench. Tilt mechanism should always be locked before starting work — and should always be unlocked before attempting to change the angle of tilt.

TILT HAND WHEEL (B) — on left side of saw, controls the angle of tilt. The saw blade can be tilted from 0° to 45°, as indicated on the **TILT GAGE (C)**. If the angle of cut (tilt) must be extremely accurate, the angle of the saw blade should be checked with a protractor or with a board which is known to be cut at the exact angle required.

RIP FENCE (E) — is operated by pushing in the **FENCE KNOB (F)** so that it engages a pinion gear with the teeth on **RACK (H)**. Turning the knob (F), after pushing it in, will cause the rip fence to move accurately across the table. When the knob (F) is pulled out to disengage pinion gear, the rip fence can be moved across the table by hand. Keep the saw table and rip fence clean. Dirt may prevent the rip fence from obtaining proper alignment. Tapping the fence lightly to assist the mechanism to find its natural position, will help to maintain alignment of the fence with the blade.

CAM CLAMP LEVER (G) — is used to clamp the rip fence in place after it has been moved to the position desired.

MITER GAGE (J) — is used in table grooves as a guide for the workpiece when the fence is not used. The angle of the gage can be adjusted by loosening **CLAMP KNOB (K)** and positioning gage as indicated by the dial and pointer on (J).

MITER GAGE STOP ROD (L) — can be adjusted in length by loosening **WING NUT (M)**. This rod is used as a positioning guide for the end of the workpiece.

CAUTION

Under no circumstances should a blade with a diameter greater than 10 inches be used with this saw.

OPERATING ADJUSTMENTS

ADJUSTING TILT GAGE — Using an accurate square, set saw blade at right angles to table top. Then adjust the pointer on the tilt gage (C, fig. 2) to "0".

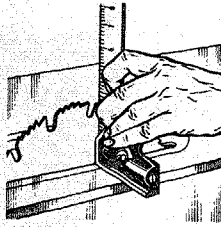

ADJUSTING MITER GAGE SCALE — Using an accurate square, block the miter gage at the square position. Make a trial cut on a fairly wide board, then check this cut with the square. If cut is accurate, set the pointer on the miter gage scale (J, fig. 2) to "90".

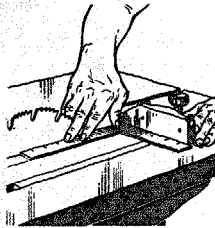

ADJUSTING FENCE INDICATORS — Adjust right-hand fence indicator (part 135, fig. 4) by positioning fence

so that it touches the right side of the saw blade — then set indicator at "0". Move fence to left side of blade and adjust left-hand indicator in like manner.

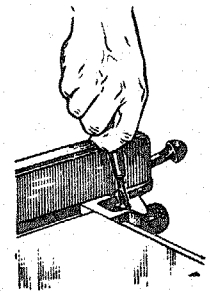

ADJUSTING CAM CLAMP LEVER — If clamping action of lever (G, fig. 2) is too tight or too loose, it can be adjusted by increasing or decreasing the effective length of the rip fence clamp rod (part 6409, fig. 4). This is done by readjusting the clamp rod nut (part 6407, fig. 4) on the end of the clamp rod in back of the fence. When properly adjusted, the clamping lever should lock in a horizontal position or slightly lower.

LUBRICATION

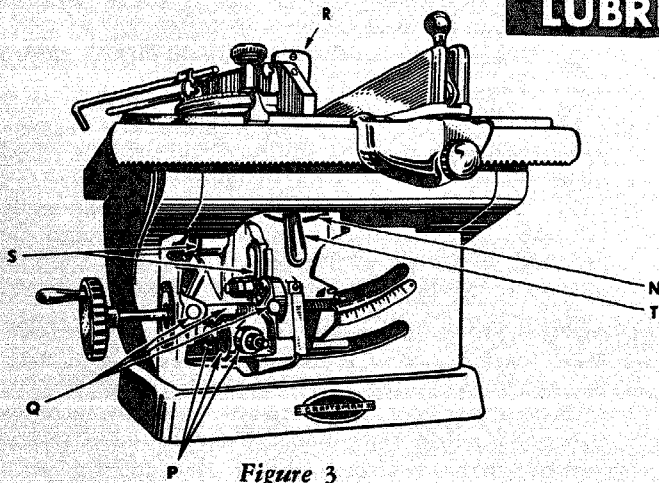

Figure 3

quire no additional lubrication. Other parts requiring lubrication should be oiled frequently with SAE No. 20 or No. 30 Automobile Engine Oil. See figure 3.

- N — Table trunnions — in which cradle tilts.
- P — Lift screw block, lift screw threads, and lift nut.
- Q — Tilt screw block, tilt screw threads, and tilt nut.
- R — Friction points in saw guard.
- S — Spindle arm pin and saw arbor housing guide bosses.
- T — Saw tilt clamp screw.

All other points where there is friction between two or more moving surfaces — or where a slip fit is necessary for adjustment purposes.

Special attention should be given to the moving parts in the rip fence and miter gage.

To prevent the saw table from rusting, it should be kept covered with a film of our "Stop Rust" when not in use — and should be wiped off with a cloth before using. Treat other unplated and unpainted parts and surfaces in same manner.

Your saw is a fine machine and should be given the best of care. If kept clean and properly lubricated, it will give many years of trouble-free service.

The saw arbor bearings (part 3509, fig. 5) have been packed at the factory with the proper lubricant and re-

PROPER OPERATING PROCEDURES

DRESS PROPERLY — Do not wear a tie or other loose article. Keep long sleeves down with cuffs fastened; or wear short sleeves. Use goggles or a face shield to protect the eyes.

NEVER STOP BEING CAREFUL — One moment of inattention can cost you a painful injury. Always be alert! Operation of saw is simple, safe and easy — when properly done.

A LOW BLADE IS THE SAFEST — Equally good cuts can be made with the blade elevated to full height, or raised just enough to clear top of work-piece by approximately 1/4 inch. The lower position is safer because the blade

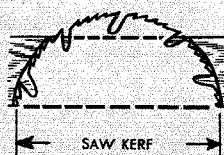

enters the work at an angle more nearly parallel with the direction of feed, and there is better opportunity to hold the work against kickback.

AVOID AWKWARD HAND POSITIONS — Do not get hands into a position in which a sudden slip can cause them to move into the saw blade. Pull work through from behind blade rather than push it through with hand in close quarters; or use a push stick as illustrated. Do not attempt freehand cross-cutting; always use miter gage.

NEVER TWIST WORK — Twisting work will bind blade and cause a kickback.

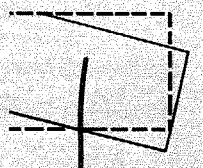
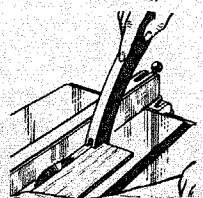
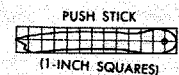

STANDARD SAW OPERATIONS

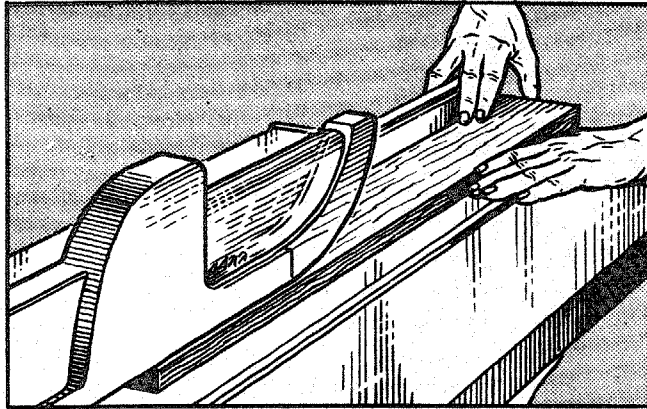

RIPPING

Ripping is the sawing of wood with the grain. It is generally done with the help of a fence as a guide to position and maintain the work at the correct width for the cut. Because the work is pushed along the fence, it must have a reasonably straight edge to make sliding contact with the fence. Also, work must make solid contact with the table, so that it will not wobble. Provide a straight edge, even if this means temporary nailing of an auxiliary straight edge board to the work. If workpiece is warped, turn the hollow side down.

Use of the saw guard is recommended; and the splitter should always be used in ripping operations. Wood cut with the grain tends to spring the kerf closed and bind the blade. If for any reason, splitter is not used, stop and insert a wedge in the kerf just as soon as cut has passed back of blade.

Set fence to desired width of cut, either by using the scale on the fence guide bar, or by measuring the distance between blade and fence. Fence is almost always used on right-hand side of blade. Stand a little to the right of center to avoid being sprayed with sawdust and to be clear of work in case of a kickback. Start saw and advance work, using left hand to hold it down and right hand to push it forward. As cut nears completion, move left hand to safe distance from blade, and push work through with right hand alone. Never reach in back of blade with either hand to hold work down.

When there is less than the width of your palm between fence and blade, do not attempt to push work through by hand. Use a push stick like that shown on preceding page, or pull work through from behind saw.

Do not leave a long board unsupported so that the spring of the board causes it to shift on the table. Use some sort of support to catch end of board behind blade; and if board is very long, use another support in front of saw.

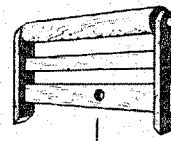

ROLLER SUPPORT

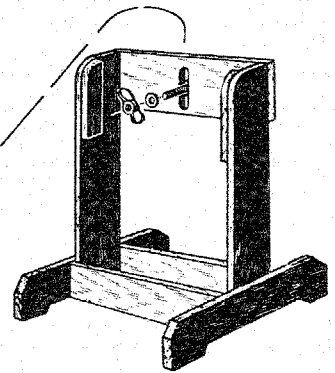

RESAWING

Resawing is the cutting of thick boards into thinner ones. It is a ripping operation. Small boards — up to $3\frac{3}{8}$ -inch maximum width — can be resawed in one pass; but larger boards up to $6\frac{1}{4}$ -inch maximum require two passes, one pass along each edge of the board.

When two cuts from opposite edges are required, these should be made to overlap $\frac{1}{2}$ inch from the approximate center of the board. If the first cut is too deep, the kerf will close and bind the saw on the second cut, with danger of kickback. Also, when the kerf closes, the two sides of the cut are no longer parallel to the saw blade, and the saw will cut into them to spoil their appearance. Keep same face of board against fence when making both cuts.

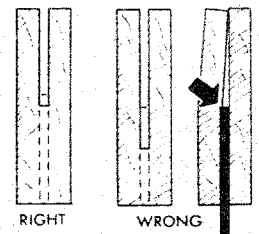

CROSSCUTTING

Crosscutting is the sawing of wood across the grain. Planks are milled with the grain running the length of the plank. In crosscutting the long edge of the work is placed across the table top. Therefore, the miter gage is used as a guide instead of the fence. Most operators prefer to use the left-hand table groove. In this case, the left hand is used to hold the work in contact with the gage and to push work and gage toward the blade. The right hand is free to assist, as required. If right-hand groove is used, hand positions are reversed.

Ordinarily the gage is placed in the table groove with the bar in front. When work is so wide that it completely

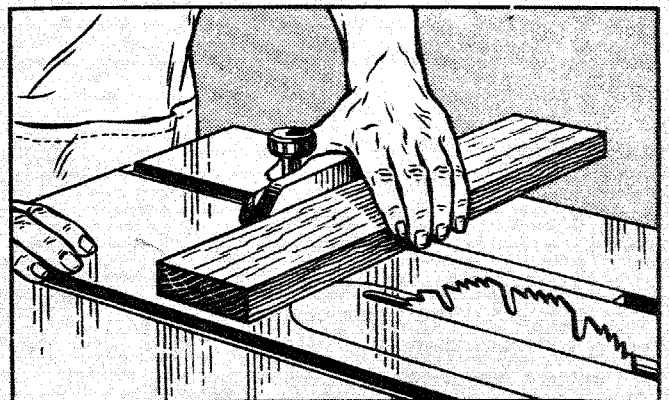

CROSSCUTTING — Continued

covers table in front of blade, the gage should be reversed. Square crosscutting is done with the miter gage set at "90" (at a right angle to the slide and groove). The splitter need not be removed, but is not needed for this operation. Start the cut slowly and hold work firmly to table to prevent kick-back or chatter. (Loosely held workpieces will sometimes vibrate against table when crosscutting. This tends to bind blade and dull teeth.) An auxiliary wooden extension bolted to miter gage greatly improves the gage as a support. If fitted with pin points (phonograph needles are excellent) or sandpaper, the extension will help prevent side creep of the work. If workpiece overhangs table enough to sag at each end, provide supports the same as in ripping operations. The stop rod on the miter gage, or a stop block fastened to the extension, is used to fix position of left-hand edge of work for measuring length of piece to be cut off.

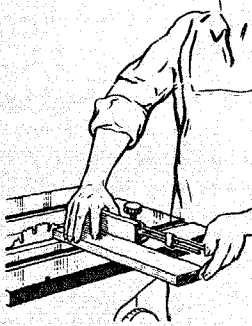
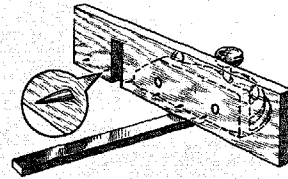
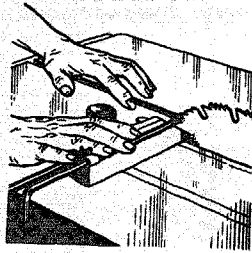

BEVEL AND MITER CUTS

Bevels from 1° to 45° are cut by tilting the saw blade. Operations are the same as for ripping or crosscutting—but work should be extra well supported to prevent creep. Miters are crosscuts at an angle to the edge of the workpiece. The miter gage is set at the required angle to make the cut. Here also, precautions must be taken to prevent creep.

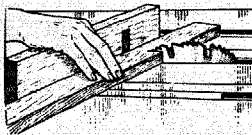

USE OF THE DADO HEAD

The dado saw or head, as it is called, is a special set of blades for cutting grooves and dados on the circular saw. Dado heads can be purchased at any Sears Retail Store or Mail Order House. The head consists of two solid, stiff outside blades, and a number of inside chipper blades. The outside blades are 1/8-inch thick; there is one 1/4-inch, two 1/8-inch, and one 1/16-inch chipper blades. With these blades, grooves of 1/8 inch, 1/4 inch, and additional widths increased in steps of 1/16 inch up to a maximum of 13/16-

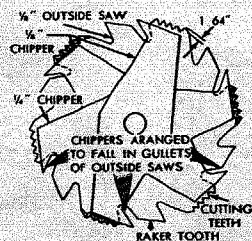
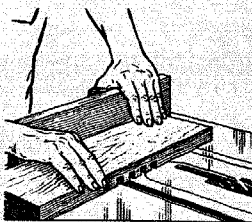

inch wide can be cut. Outside blades can be used alone, chippers cannot.

A dado insert (part 9-2212, fig. 4) must be used to replace the standard table insert. Whenever two or more chippers are used, stagger the swaged ends as evenly as possible around the circumference. Fractional adjustments in thickness of the head can be made by using paper washers between the outside blades and chippers.

Dado head operations are much the same as those with a standard blade—but the dado head takes a bigger bite, so that workpiece should be held more firmly. It is good practice to use a hold-down jig like the one illustrated.

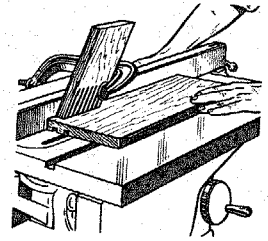

When a groove wider than the dado head is needed, make two or more passes. Best method is to use a notched stop block to position each successive cut. Block is fastened to edge of table where it can be used to position work before starting the cut; but in such a position that it will not contact work during the cutting operation. Space cuts so that they overlap a trifle.

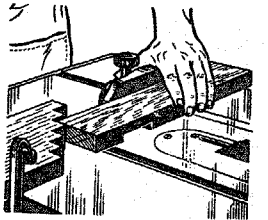

When cutting a gain—a groove that is closed at one end—use a stop block to fix the end of the cut. To locate the stop, place work alongside dado head in position in which it will be when cut is finished, then rig the stop at the end of the work. When cutting a stopped groove—which is closed at both ends—also use a starting block, as shown in the illustration. This is located in same manner as the stop block.

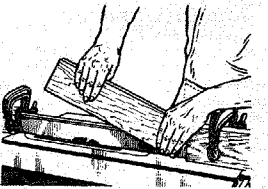

SANDING

A sanding wheel can also be mounted on the saw arbor—and the tilting arbor of the saw gives much versatility for fine sanding operations.

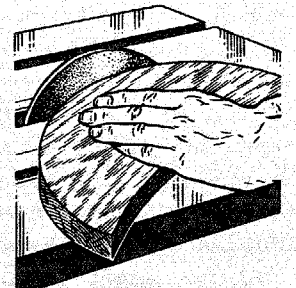

Instructions for Ordering Parts

All parts illustrated in Figures No. 4 and No. 5 and listed on the following pages under part numbers must be ordered through a Sears Retail Store or Mail Order House. Many screws, nuts, washers, etc., are standard items and may be purchased locally by noting the specifications listed for these parts.

In several instances part numbers are listed for COMPLETE ASSEMBLIES. The part numbers of the COMPLETE ASSEMBLIES, however, do not appear on the illustrations.

All parts are shipped prepaid within the limits of the continental United States.

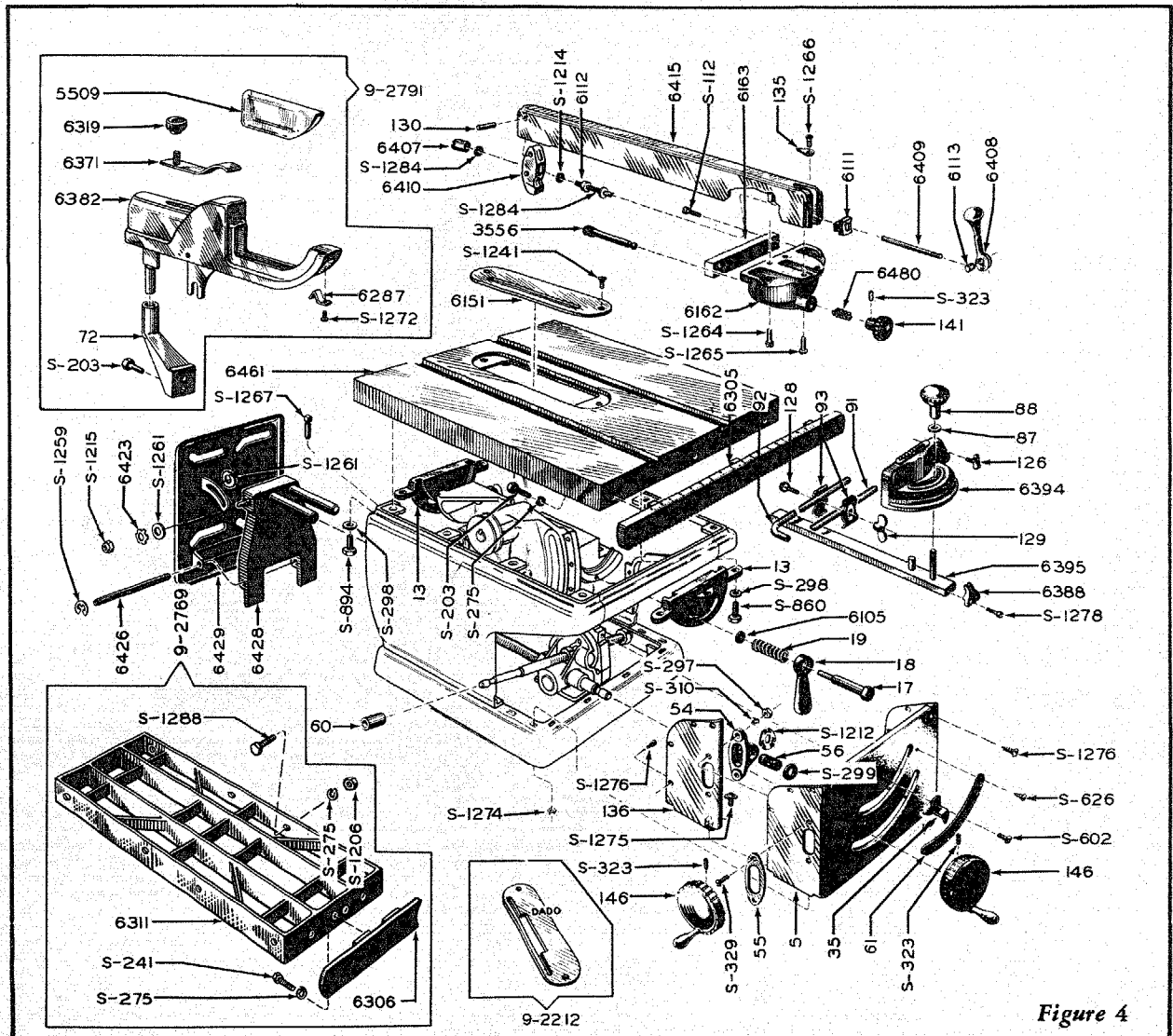

Figure 4

FIGURE 4 PARTS LIST

| Part No. | NAME OF PART | Part No. | NAME OF PART | Part No. | NAME OF PART |
|----------|---------------------------------|----------|--------------------------------|----------|---|
| 6403 | MITRE GAGE ASSEMBLY | 6287 | Guard Insert Spring Clip | 17 | Clamp Screw |
| 87 | Mitre Gage Washer | 6319 | Clamping Knob | 18 | Clamp Screw Handle |
| 88 | Mitre Clamp Knob | 6371 | Lift Plate Assembly | 19 | Clamp Screw Spring |
| 91 | Mitre Exten. Rod (Straight) | *6382 | Guard and Splitter Blade Assy. | 35 | Tilt Lift Pointer |
| 92 | Mitre Exten. Rod | 6417 | RIP FENCE ASSEMBLY | 54 | Tilt Bearing Bracket |
| 93 | Mitre Rod Clamp | 130 | Rip Fence Clamp Pin | 55 | Tilt Bearing Plate |
| 126 | Mitre Thumb Screw | 135 | Rip Fence Indicator | 56 | Tilt Screw Block |
| 128 | Carriage Bolt (3/16" dia.x3/4") | 141 | Rip Fence Knob | 60 | Tilting Screw Sleeve |
| 129 | Wing Nut 10-24 | 3556 | Rip Fence Pinion | 61 | Tilt Gage |
| 6388 | Mitre Gage Pointer | 6111 | Cam Face | 72 | Splitter Blade Bracket |
| 6394 | Mitre Gage | 6112 | Rip Fence Clamp Cushion | 136 | Front Panel Stiffener |
| 6395 | Mitre Gage Clamp Assy. | 6113 | Cam Clamp Lever Insert | 146 | 3-1/2" Hand Wheel Assembly |
| 6427 | MOTOR SUPPORT ASSEMBLY | 6162 | Rip Fence Guide | 6105 | Clamp Screw Washer |
| 6423 | Spring Washer | 6163 | Alignment Bar Assembly | 6151 | Table Insert |
| 6426 | Motor Support Hinge Rod | 6407 | Clamp Rod Nut | 6305 | Fence Slide Gear Rack |
| 6428 | Motor Base Support Assembly | 6408 | Cam Clamp Lever | 6306 | Extension Rack |
| 6429 | Motor Base & Bracket Assembly | 6409 | Rip Fence Clamp Rod | 6311 | Table Extension |
| S-1215 | 1/4-20 Elastic Stop Nut | 6410 | Rip Fence Clamp | 6461 | Table |
| S-1259 | Retaining Ring | 6415 | Rip Fence | S-298 | .380 x 7/8 x 1/16 Steel Washer |
| S-1261 | .253 x 3/4 x 1/16 Steel Washer | 6480 | Rip Fence Pinion Spring | S-299 | .758 x 1 x .047 Steel Washer |
| 5509 | Guard Insert 10" Saw | 5 | Front Panel | S-626 | 8 x 5/16 Style Z Sheet Metal Screw |
| | | 13 | Table Trunnion | S-1212 | Spring Washer |
| | | | | S-1276 | 10 x 3/8 Rd. Hd. Type Z Sheet Metal Screw |

* This part must be purchased as an assembly or the complete part returned to the manufacturer for repairs.

In figure 4 above the parts included in the three blocks are not furnished with the saw. See page 8 for ordering information on these items.

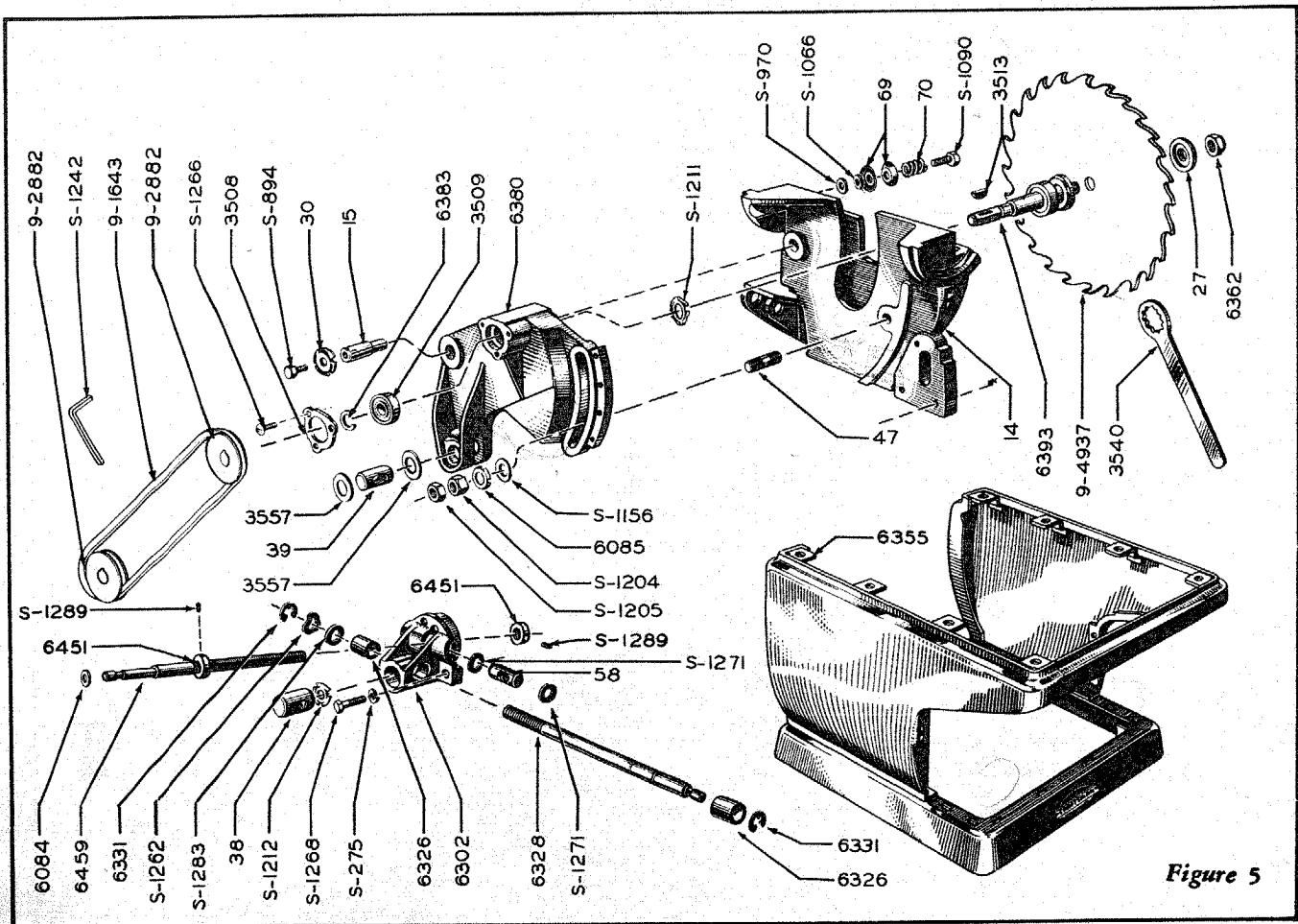

FIGURE 5 PARTS LIST

| Part No. | NAME OF PART | Part No. | NAME OF PART | Part No. | NAME OF PART |
|----------|---------------------------|----------|---------------------------------|----------|----------------------------------|
| 6392 | SAW ARBOR HOUSING ASSY. | 47 | Saw Arbor Retaining Stud | 6302 | Tilt Lift Nut Bracket |
| 27 | Loose Collar | 30 | Spindle Arm Retaining Washer. | 6326 | Lift Screw Collar |
| 3508 | Arbor Bearing Retainer | 38 | Lift Screw Block | 6328 | Lift Screw |
| 3509 | Saw Arbor Bearing | 39 | Lift Nut | 6331 | Retaining Ring |
| 3513 | Saw Arbor Key | 58 | Tilt Nut | 6355 | Saw Base Assembly |
| 6362 | Saw Arbor Nut | * 69 | Splitter Blade Clamp Washer | 6451 | Stop Collar |
| 6383 | Saw Arbor Shaft Snap Ring | * 70 | Splitter Blade Clamp Spring | 6459 | Tilt Screw |
| 6393 | Saw Arbor Assembly | 3540 | Arbor Wrench | * S-970 | 7/16 x 3/4 x .0239 Steel Washer |
| 6380 | Saw Arbor Housing | 3557 | Lift Nut Washer | * S-1066 | 7/16 x 3/4 x .0299 Steel Washer |
| S-1211 | Spring Washer | 6084 | Tilting Screw Spacer | S-1212 | Spring Washer |
| 3570 | CRADLE ASSEMBLY | 6085 | Saw Arbor Retaining Stud Washer | S-1262 | Spring Washer |
| 14 | Cradle | | | S-1271 | .758 x 1 x 1/32 Fibre Washer |
| 15 | Spindle Arm Pin | | | S-1283 | .693 x 15/16 x 1/64 Steel Washer |

The following parts shown on Figures 4 and 5 are standard and can be purchased locally:

| Part No. | NAME OF PART | Part No. | NAME OF PART | Part No. | NAME OF PART |
|----------|---|----------|--|----------|---|
| S-112 | 10—32 x 1/2 Fil. Hd. Mach. Screw | * S-1090 | 3/8—16 x 1-1/4 Hex. Hd. Cap Screw | S-1266 | 8—32 x 5/16 Pan Hd. or Rd. Hd. Mach. Screw |
| S-203 | 5/16—18 x 3/4 Hex. Hd. Cap Screw | S-1156 | 9/16 x 1-3/8 x 7/64 Flat Steel Washer | S-1267 | 5/16—18 x 5/8 Sq. Hd. Set Screw |
| S-241 | 5/16—18 x 7/8 Hex. Hd. Cap Screw | S-1204 | 1/2—13 x 13/16 x 7/16 Hex. Nut | S-1268 | 5/16—18 x 1-3/16 Hex. Hd. Cap Screw |
| S-275 | 5/16 SAE Med. Lockwasher | S-1205 | 1/2—13 x 13/16 x 5/16 Jam Nut | S-1272 | 8—32 x 3/16 Pan Hd. Mach. Screw |
| S-297 | 1/4—20 x 3/16 Hex. Nut | S-1206 | 5/16—18 x 7/32 Hex. Nut | S-1274 | 10—32 x 3/8 x 1/8 Hex. Nut |
| S-310 | 1/4 SAE Med. Lockwasher | S-1241 | 8—32 x 5/16 Flat Hd. Steel Mach. Screw | S-1275 | 10—32 x 1/2 Rd. Hd. Mach. Screw with External Lock Washer |
| S-323 | 1/4—20 x 1/4 Cup Pt. Slotted Headless Set Screw | S-1242 | Allen Wrench for 5/16 Set Screw | S-1278 | 8—32 x 1/4 Pan Hd. Mach. Screw with External Lock Washer |
| S-329 | 1/4—20 x 1 Rd. Hd. Mach. Screw | S-1264 | 10—32 x 1/2 Pan Hd. or Rd. Hd. Mach. Screw | S-1284 | 17/64 x 5/8 x 1/32 Plain Steel Wash. |
| S-602 | 10—32 x 3/8 Rd. Hd. Mach. Screw | S-1265 | 10—32 x 3/4 Pan Hd. or Rd. Hd. Mach. Screw | S-1288 | 5/16—18 x 1-1/8 Hex. Hd. Cap Screw |
| S-860 | 3/8—16 x 1 Hex. Hd. Cap Screw | | | S-1289 | 10—32 x 1/8 Headless Slotted Cup Pt. Set Screw |
| S-894 | 3/8—16 x 1/2 Hex. Hd. Cap Screw | | | | |

The following parts shown on Figures 4 and 5 may be ordered through any Sears Retail Store or Mail Order House:

| Stock No. | NAME OF PART | Stock No. | NAME OF PART |
|-----------|--------------------------|-----------|--|
| 9-1643 | 43" x 1/2" V-Belt | 9-2791 | Saw Guard Assembly |
| 9-2212 | Dado Insert | 9-2882 | 2 1/2" x 5/8" Bore Single Groove V-Pulley |
| 9-2769 | Bench Saw Side Extension | 9-4955 | 10" x 5/8" Bore Chisel Tooth Comb. Saw Blade |

* These Parts supplied with Guard Assembly Cat. No. 9-2791.