

OPERATOR'S MANUAL MANUAL DEL USUARIO

CRAFTSMAN®

24V MAX* LITHIUM-ION CORDLESS CHAINSAW MOTOSIERRA SIN CUERDA, CON BATERÍA DE IONES DE LITIO DE 24 V MÁX.*

Model No. 151.74931
(INCLUDES battery & charger)

Modelo n° 151.74931
(INCLUYE batería y cargador)

Model No. 151.74941
(Battery & charger NOT INCLUDED)

Modelo n° 151.74941
(Batería y cargador NO INCLUIDOS)

NOTE: BAR & CHAIN OIL NOT INCLUDED.
BAR & CHAIN OIL MUST BE ADDED PRIOR TO USE.

NOTA: ACEITE PARA BARRA Y CADENA NO INCLUIDO.
SE DEBE AÑADIR ACEITE PARA BARRA Y CADENA ANTES DE USAR.

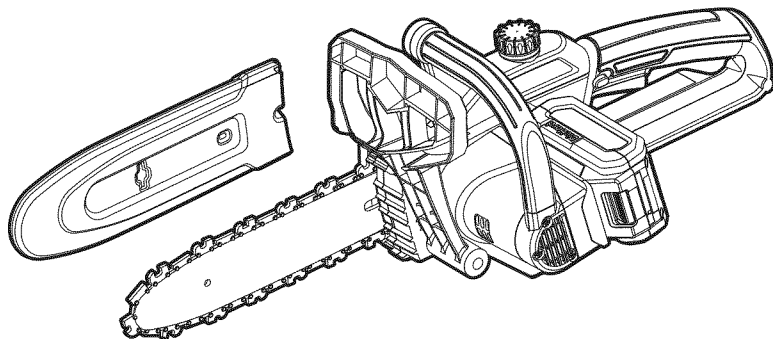

⚠ CAUTION: To reduce the risk of injury, the user must read and understand the operator's manual before using this product.

⚠ PRECAUCIÓN: Para reducir el riesgo de lesiones, el usuario debe leer y comprender el manual antes de utilizar este producto.

Sears Brands Management Corporation, Hoffman Estates, IL 60179 USA

Visit the Craftsman web page: www.craftsman.com

Visite el sitio Web de Craftsman: www.craftsman.com

**Save this manual for future reference
Conserve este manual para futura referencia.**

* Maximum initial battery voltage (measured without workload) is 24 volts.
Nominal working voltage is 21.6 volts.

* La tensión inicial máxima de la batería (medida sin carga) es 24 voltios.
La tensión de trabajo nominal es 21,6 volts.

Intertek
3084514

TABLE OF CONTENTS / TABLA DE CONTENIDOS

ENGLISH

■ Warranty	2
■ Introduction	2
■ General Safety Instructions	3-5
■ Specific Safety Instructions	6
■ Symbols	7-8
■ Features	9
■ Assembly	10
■ Battery Pack and Charger	11-12
■ Operation	13-18
■ Care and Maintenance	19-24
■ Environmentally Safe Battery Disposal	25
■ Troubleshooting	25
■ Illustrated Parts List	26-27
■ Figure Numbers (Illustrations)	i-xi

ESPAÑOL

■ Garantía	Sección de Inglés pág. 2
■ Introducción	Sección de Inglés pág. 2
■ Instrucciones generales de seguridad	3-5
■ Instrucciones específicas de seguridad	6
■ Símbolos	7-8
■ Características	9
■ Armado	10
■ Batería y cargador	11-13
■ Funcionamiento	14-20
■ Cuidados y mantenimiento	20-26
■ Eliminación ambientalmente segura de la batería ..	27
■ Resolución de problemas	28
■ Lista de piezas, ilustrada	29-30
■ Números de las figuras (ilustraciones)	i-xi

CRAFTSMAN LIMITED WARRANTY

FOR TWO YEARS from the date of sale, this power tool is warranted against defects in material or workmanship.

FOR ONE YEAR from the sale date a supplied battery pack or charger is warranted against material or workmanship defects.

WITH PROOF OF SALE, a defective product will be replaced free of charge.

For warranty coverage details to obtain free replacement, visit the web page:

www.craftsman.com/warranty

This warranty does not cover the bar and chain which are expendable parts that can wear out from normal use within the warranty period.

This warranty is void if this product is ever used while providing commercial services or if rented to another person.

This warranty gives you specific legal rights, and you may also have other rights which vary from state to state.

Sears Brands Management Corporation, Hoffman Estates, IL 60179

GARANTÍA LIMITADA CRAFTSMAN

* * *

DURANTE DOS AÑOS a contar de la fecha de venta, esta herramienta está garantizada contra defectos en sus materiales o fabricación.

DURANTE UN AÑO a contar de la fecha de venta, la batería o cargador incluidos con la herramienta están garantizados contra defectos en sus materiales o fabricación.

Un producto defectuoso puede reemplazarse por uno nuevo, de manera gratuita, considerando que se presente una PRUEBA DE VENTA.

Para conocer la cobertura de la garantía y obtener un reemplazo gratuito, visite el sitio Web

www.craftsman.com/warranty

Esta garantía no cubre la barra ni la cadena, las cuales son piezas desechables que pueden desgastarse debido al uso normal dentro del periodo de garantía.

La garantía de un año se anula si el producto se usa para proporcionar servicios comerciales o si se le arrienda a otra persona.

Esta garantía le entrega derechos legales específicos que pueden variar según su estado (podría tener otros derechos adicionales).

Sears Brands Management Corporation, Hoffman Estates, IL 60179

INTRODUCTION / INTRODUCCIÓN

This tool has many features for making its use more pleasant and enjoyable. Safety, performance, and dependability have been given top priority in the design of this product making it easy to maintain and operate.

* * *

Esta herramienta tiene muchas funciones para hacerla más agradable y cómoda de usar. Se ha dado máxima prioridad a la seguridad, rendimiento y dependencia en las etapas de diseño de este producto para que sea fácil de utilizar y mantener.

GENERAL SAFETY INSTRUCTIONS

⚠ WARNING!

Read and understand all instructions. Failure to follow all instructions listed below may result in electric shock, fire and/or serious personal injury:

BASIC SAFETY PRECAUTIONS

- Do not operate a chainsaw with one hand! Use a firm grip with thumbs and fingers encircling the chainsaw handles. Serious injury to the operator, helpers, bystanders, or any combination of these persons may result from one-handed operation. A chainsaw is intended for two-handed use.

- Hold the power tool by insulated gripping surfaces only, because the saw chain may contact hidden wiring.

- Always be aware of what you are doing when using the chainsaw. Use common sense. Do not operate the chainsaw when you are tired, ill, or under the influence of alcohol, drugs, or medication.

- Stay alert and pay attention to what you are doing. Use common sense when using this unit.

- Keep all parts of your body away from the saw chain when the unit is running.

- Never let anyone use your chainsaw who has not received adequate instructions in its proper use. This applies to rentals as well as privately owned saws.

- Before you start the unit, make sure the saw chain is not contacting any object.

- Stop the chainsaw before setting it down. Do not leave the unit running unattended.

- To avoid accidental starting, never carry the unit with your finger on the trigger switch.

- Maintain the unit with care. Keep the cutting edge sharp and clean for best performance and to reduce the risk of injury. Follow instructions for lubricating and changing accessories.

- Do not operate charger with a damaged

cord or plug, which could cause shorting and electric shock. If damaged, immediately discontinue use. Replace the charger with the identical unit as listed in the Parts List of this manual.

- Keep handles dry, clean, and free of oil and grease.

- Do not operate a chainsaw that is damaged, improperly adjusted, or not completely and securely assembled. Chain should stop turning when the trigger switch is released. If chain turns after the trigger switch has been released, discontinue chainsaw use immediately. If within warranty period, return unit to retailer of purchase for possible product replacement.

- Check for damaged parts. Any part or guard that has been damaged should be carefully checked to determine that it will operate properly and perform its intended function. Check for alignment of moving parts, binding of moving parts, breakage of parts, mounting, and any other conditions that may affect its operation. If guard or other part is damaged, discontinue chainsaw use immediately. Replace part with identical part as listed in the Parts List of this manual.

- Do not use in the rain, snow or wet conditions.

- Always maintain a proper stance. Do not overreach.

- Do not adapt your power head to a bow guide or use it to power any attachments or devices not listed for the saw.

- Do not cut vines and/or small underbrush.

CALIFORNIA PROPOSITION 65

⚠ WARNING!

This product and substances that may become airborne from its use may contain chemicals, including lead, known to the State of California to cause cancer, birth defects, or other reproductive harm.

Wash hands after handling.

GENERAL SAFETY INSTRUCTIONS

SAFETY APPAREL

- Wearing snug fitting clothing. Always wear heavy, long pants, long sleeves, overalls, jeans or chaps made of cut resistant material or ones that contain cut resistant inserts. Wear non-slip safety footwear. Wear non-slip heavy duty gloves to improve your grip and protect your hands. Do not wear jewelry, short pants, sandals, or go barefoot. Do not wear loose fitting clothing, which could be drawn into the motor or catch the chain or underbrush. Secure hair so it is above shoulder level.
- Always wear eye protection with side shields marked to comply with ANSI Z87.1, along with head protection.

KICKBACK

See Figures 1-3, page 1

▲WARNING!

Kickback may occur when the moving chain contacts an object at the upper portion of the tip of the guide bar or when the wood closes in and pinches the saw chain in the cut. Contact at the upper portion of the tip of the guide bar can cause the chain for an instant. The result is a lightning fast, reverse reaction which kicks the guide bar up and back toward the operator. If the saw chain is pinched along the top of the guide bar, the guide bar can be driven rapidly back toward the operator, either of these reactions can cause loss of saw control which can result in serious injury. Do not rely exclusively upon the safety devices built into the saw. As a chainsaw user, you should take several steps to keep your cutting jobs free from accident or injury.

- The following precautions should be followed to minimize kickback:
 - Always grip the saw firmly with both hands. Hold the saw firmly with both hands when the motor is running. Place your right hand on the rear handle and your left hand on the front handle with your thumbs and

fingers encircling the chainsaw handles. A firm grip together with a stiff left arm will help you maintain control of the saw if kickback occurs.

- Make sure that the area in which you are cutting is free from obstructions. Do not let the nose of the guide bar contact a log, branch, fence, or any other obstruction that could be hit while you are operating the saw.
- Always cut with the unit running at full speed. Fully squeeze the trigger switch and maintain a steady cutting speed.
- Use replacement parts such as low kickback chain and special guide bars that reduce the risks associated with rotational kickback.
- Use only the replacement guide bars and low kickback chains specified by the manufacturer for the saw.

- With a basic understanding of kickback, you can reduce or eliminate the element of surprise. Sudden surprise contributes to accidents.
- Keep proper footing and balance at all times.
- Do not cut above shoulder height or overreach when cutting.
- Follow the sharpening and maintenance instructions for the saw chain.
- Push and Pull - This reaction force is always opposite to the direction the chain is moving where wood contact is made. Thus, the operator must be ready to control the PULL when cutting on the bottom edge of the bar, and PUSH when cutting along the top edge. (Fig. 3)

IN THE CUTTING/WORK AREA

- Do not operate a chainsaw in a tree, on a ladder, rooftop or scaffold; this is extremely dangerous.
- Keep ALL children, bystanders, visitors, and animals out of the work area while starting or cutting with the chainsaw.

GENERAL SAFETY INSTRUCTIONS

NOTE: The size of the work area depends on the job being performed as well as the size tree or work piece involved. For example, felling a tree requires a larger work area than making bucking cuts.

- Never start cutting until you have a clear work area, secure footing, and a planned retreat path from the falling tree. Cluttered area invites injuries.
- Do not expose the chainsaw to rain.
- Do not use the chainsaw in damp or wet locations.
- Do not use the chainsaw near flammable liquids, gases, or in any type of explosive atmosphere,
- Use extreme caution when cutting small size brush and saplings, because slender material may catch the saw chain and be whipped toward you or pull you off balance.
- When cutting a limb that is under tension, be alert for spring back so that you will not be struck when the tension in the wood fibers is released.
- Do not force the chainsaw. The job can be performed better and safer at the rate for which it was intended.
- Always use the right product for your application. The chainsaw should be used for cutting wood only. Never use the chainsaw to cut plastic, masonry or non-wood building materials.
- Do not use the chainsaw for purposes not intended.
- Store idle chainsaw when not in use. Chainsaw should be stored in a dry and high or locked area out of the reach of children. When storing chainsaw, remove battery and place the chain cover on the bar and chain.
- Remove the battery pack from the chainsaw before cleaning, servicing, storing, transporting, removing material from the unit, changing accessories such as the bar and chain, or when not in use.

UNDERSTANDING YOUR CHAINSAW SAFETY DEVICES

LOW KICKBACK SAW CHAIN

The rakers (depth gauges) ahead of each cutter can minimize the force of a kickback reaction by preventing the cutters from the digging in too deeply at the kickback zone. Only use replacement chain that is equivalent to original chain or has been certified as low kickback chain per ANSI B175.1

Low kickback saw chain is chain that has met the kickback performance requirements of ANSI B175.1 - 1991 (American National Standard for Power Tools - Gasoline - Powered Chainsaws - Safety Requirements) when tested on the representative sample of chainsaws below 3.8. c.i.d. specified in ANSI B175.1 - 1991.

As saw chains are sharpened during their useful life, they lose some of the low kickback qualities and extra caution should be used.

GUIDE BARS

Generally, guide bars with small radius tips have somewhat lower kickback potentials.

When making a replacement, be sure to order the Craftsman bar listed for the saw in this operator's manual.

SPECIFIC SAFETY INSTRUCTIONS













BATTERY SAFETY

- Battery operated units do not have to be plugged into an electrical outlet; therefore, they are always in operating condition. Be aware of possible hazards even when unit is not operating.
- Remove the battery pack from the chainsaw before cleaning, servicing, storing, transporting, removing material from the unit, changing accessories such as the bar and chain, or when not in use.
- A battery pack must be recharged only with the specified charger for the battery pack. A charger that may be suitable for one type of battery pack may create a risk of fire when used with another battery pack. Use battery pack only with charger listed.
- To reduce the risk of explosion and possible injury. Do not place battery units or their battery near fire or heat.
- Do not open or mutilate the battery pack. Released electrolyte is corrosive and may cause damage to the eyes or skin. It may be toxic if swallowed.
- Do not crush, drop or damage battery pack. Do not use a battery pack or charger that has been dropped or received a sharp blow. A damaged battery is subject to explosion. Properly dispose of a dropped or damaged battery immediately.
- Batteries can explode in the presence of a source of ignition, such as a pilot light. To reduce the risk of serious personal injury, never use any cordless product in the presence of open flame. An exploded battery pack can propel debris and chemicals. If exposed, flush with water immediately.
- Do not charge unit in a damp or wet location. Following this rule will reduce the risk of electric shock.
- For best results, your battery unit should be charged in a location where the temperature is more than 50°F but less than 100°F. Do not store outside or in vehicles.
- Under extreme usage or temperature conditions, battery pack leakage may occur. If liquid comes in contact with your skin, wash immediately with soap and water, then neutralize with lemon juice or vinegar. If liquid gets into your eyes, flush them with clean water for at least 10 minutes, then seek immediate medical attention.
- Do not dispose of batteries in a fire. The cell may explode. Batteries should be recycled, consult your local waste authority for information regarding available cycling and/or disposal options.
- When battery pack is not in use, keep it away from other metal objects like: paper clips, keys, nails, screws, or other small metal objects that can make a connection from one terminal to another. Shorting the battery pack terminals together may cause sparks, burns, or a fire.











SAVE THESE INSTRUCTIONS

SYMBOLS



Some of the following symbols may be used on this product. Please study them and learn their meaning. Proper interpretation of these symbols will allow you to operate the product better and safer.

SYMBOL	NAME	DESIGNATION/EXPLANATION
V	Volts	Voltage
A	Amperes	Current
Hz	Hertz	Frequency (cycles per second)
W	Watt	Power
hrs	Hours	Time
/min	Per Minute	Revolutions, strokes, surface speed, orbits etc., per minute
n_o	No Load Speed	Rational speed, at no load
	Alternating Current	Type of current
	Direct Current	Type or a characteristic of current
	Lithium-Ion Battery Recycling	Designates that this tool is in compliance with Lithium-Ion battery recycling program requirements
	Safety Alert	Indicates a potential personal injury hazard.
	Read The Operator's Manual	To reduce the risk of injury user must read and understand operator's manual before using this product.
	Gloves	Wear non-slip, heavy-duty protective gloves when handling this product.
	Safety Footwear	Wear non-slip safety footwear when using this product.
	Wet Conditions Alert	Do not expose to rain or use in damp locations.
	Risk of Electrocution	DANGER! Risk of electrocution!
	Electric Shock	Failure to use in dry conditions and to observe safe practices can result in electric shock.
	No Hands Symbol	Failure to keep your hands away from the blade will result in serious personal injury.
	Keep Bystanders Away	Keep all bystanders at least 50' (15 m) away.
	Rain Alert	Do not expose to rain or wet conditions.

SYMBOLS

SYMBOL	NAME	DESIGNATION/EXPLANATION
	Eye Protection	Wear eye protection.
	Ear Protection	Wear ear protection.
	Bar Nose Contact	Avoid bar nose contact.
	Kickback	DANGER! Beware of kickback.
	One handed	Do not operate the saw using only one hand.
	Operate With Two Hands	Hold and operate the saw properly with both hands.
	Keep Away From Water	Do not dispose of battery packs in rivers or immerse in water.
	Keep Away From Fire	Do not dispose of battery packs in fire. They will explode or leak and cause injury.
	Heat Alert	Do not expose battery packs to heat in excess of 60°C.
	Recycle Symbol	This product uses lithium-ion batteries. Local, state, or federal laws may prohibit disposal of batteries in ordinary trash. Consult your local waste authority for information regarding available recycling and/or disposal options.

The following signal words and meanings are intended to explain the levels of risk associated with this product.

SYMBOL	SIGNAL	MEANING
	DANGER	Indicates an imminently hazardous situation, which, if not avoided, will result in death or serious injury.
	WARNING	Indicates a potentially hazardous situation, which, if not avoided, could result in death or serious injury.
	CAUTION	Indicates a potentially hazardous situation, which, if not avoided, may result in minor or moderate injury.
	CAUTION	(Without Safety Alert Symbol) Indicates a situation that may result in property damage.

FEATURES

PRODUCT SPECIFICATIONS

Type.....	Cordless, battery-powered
Motor	24V max* d.c.
Guide Bar Length	10 inch
Oil Tank Capacity.....	30 ml
Chain Speed.....	4.3 m/s
Max. Cutting Diameter.....	9 inch
Weight with Battery.....	6.50 lbs (2.95 kg)
Weight without Battery.....	5.47 lbs (2.48 kg)

BatteryMODEL #71.98724 (24LB2513) 24V max* d.c., 2.5 Ah Lithium-Ion

Charger

Model No.	24LFC14-ETL
Rated Input Voltage	120VAC
Rated Output Voltage	24VDC
Rated Output Current	2.5A
Charging Time from Zero to Full Charge	70 minutes

Bar and Saw Chain

Oregon® Bar = 581852

Oregon® Chain = 91PX040X

KNOW YOUR CHAINSAW

See Figure 4, page ii

The safe use of this product requires an understanding of the information on the product and in this operator's manual as well as a knowledge of the project you are attempting. Before use of this product, familiarize yourself with all operating features and safety instructions.

NOTE: BAR & CHAIN OIL NOT INCLUDED.
BAR & CHAIN OIL MUST BE ADDED
PRIOR TO USE.

REUSABLE SCABBARD

The scabbard keeps the operator from coming in contact with the sharp chain when the tool is not in use. It also helps keep the saw chain from being nicked or damaged when the tool is in storage.

CHAIN TENSIONING KNOB

This feature allows user to adjust the tension of the chain.

QUICK-VIEW OIL INDICATOR

Semi-transparent oil reservoir that allows user to see when to add oil.

ASSEMBLY

UNPACKING

This product has been shipped completely assembled.

- Carefully remove the product and any accessories from the box. Make sure that all items listed in the packing list are included.

 **WARNING!** Do not use this product if any parts on the Packing List are already assembled to your product when you unpack it. Parts on this list are not assembled to the product by the manufacturer and require customer installation. Use of a product that may have been improperly assembled could result in serious personal injury.

- Inspect the product carefully to make sure no breakage or damage occurred during shipping.

- Do not discard the packing material until you have carefully inspected and satisfactorily operated the product.

- If any parts are damaged or missing, do not operate the product. Return it for replacement to the retailer from which it was purchased.

151.74931 (KIT) PACKING LIST

24V Cordless Chainsaw with Bar, Chain and Scabbard

(1) 24V Max* 2.5 Ah Lithium-Ion Battery

(1) 24V Max* Battery Charger

Operator's Manual

151.74941 (TOOL ONLY) PACKING LIST

24V Cordless Chainsaw with Bar, Chain and Scabbard

Operator's Manual

BATTERY

IMPORTANT! The battery pack is not charged when the chainsaw is purchased. Before using the chainsaw, read all safety precautions and follow the instructions in the Battery Pack And Charger section. With regular use, the battery pack will need shorter charging time. If storing chainsaw for a prolonged period of time, remove the battery pack. When ready to use chainsaw again, charge the battery pack for at least 70 minutes.

 **WARNING!** If any parts are damaged or missing do not operate this product until the parts are replaced. Use of this product with damaged or missing parts could result in serious personal injury.

 **WARNING!** Do not attempt to modify this product or create accessories not recommended for use with this product. Any such alteration or modification is misuse and could result in a hazardous condition leading to possible serious personal injury.

 **WARNING!** To prevent accidental starting that could cause serious personal injury, always remove the battery pack from the product when assembling parts.

CHAIN AND GUIDE BAR ASSEMBLY

The saw chain and guide bar are pre-assembled at delivery. Inspect and re-assemble them before operation if necessary.

Use only the guide bar and saw chain listed in the Product Specifications of this manual.

To remove and replace bar and saw chain, refer to REPLACING THE GUIDE BAR AND CHAIN in the CARE AND MAINTENANCE section of this manual.

NOTE: BAR & CHAIN OIL NOT INCLUDED. BAR & CHAIN OIL MUST BE ADDED PRIOR TO USE.

BATTERY PACK AND CHARGER

BECOME FAMILIAR WITH THE CHARGER

See Figure 5, page iii

Before attempting to use this charger, become familiar with all of its operating features and safety requirements.

CHARGING THE BATTERY PACK

See Figure 6, page iii

WARNING!

- If any part of the charger is missing or damaged, do not operate it! Replace the charger with a new one. Failure to heed this warning could result in possible serious injury.
- Check the voltage! The voltage must comply with the information on the rating label.

BATTERY CHARGING PROCEDURE

- Align the battery pack to the slots on the charger and slide it in until it locks in place.
- Connect the charger to the power supply.
- Allow sufficient charging time (see Product Specifications), and then disconnect the charger from the power supply.
- Press the release button on the battery pack and remove it from the charger.

NOTE: It is normal for the battery pack and charger to become warm (but not hot) during charging process. If the battery does not charge properly, check to make sure the electrical outlet is "live".

Always charge the battery before storage!





 WARNING! To reduce risk of fire, never leave the battery connected with the charger for more than 24 hours!

- Do not use other battery chargers. The battery charger supplied is specifically designed for the Lithium-Ion battery used in this garden appliance.
- Check the main power supply! The voltage of the power supply must correspond with the data on the nameplate of the battery charger. Battery chargers operate on 120V.
- The battery is equipped with a temperature monitor that allows charging only within a temperature range between 23°F and 122°F. This ensures an optimum battery service life.

NOTE: The battery is supplied partially charged. To ensure full capacity of the battery, charge the battery in the battery charger before using the product for the first time. The Lithium-Ion battery can be charged at any time without reducing its service life. Interrupting the charging procedure does not affect the battery.

CHARGER INDICATORS

- **Preparation:** The charging process starts as soon as the battery charger is plugged into a power supply socket and the battery is inserted into the charger.
- If the battery is not inserted, a **continuous red light** indicates that the charger is plugged into a power supply socket and is now ready to begin charging.
- **Charging:** a **flashing green LED** on the charger indicates that the battery is charging normally.
- **Charged:** **continuous green LED** on the charger indicates that the battery is ready for use.
- The indicator lights on the charger show the charger status:

SYMBOL	INDICATOR LIGHTS	STATUS
	red, blinking	charging problem; see Technical Issue
	red, continuous	connected to power supply
	green, blinking	charging
	green, continuous	fully charged

Charger Indicator Panel

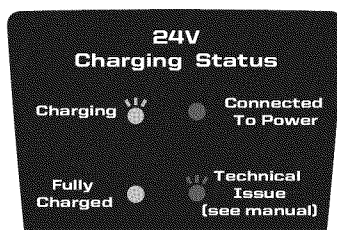

BATTERY PACK AND CHARGER

■ The intelligent charger ensures maximum battery life, because it measures the existing charge level of the battery and then charges with the required current and voltage. Charge battery fully before storage.

■ **Technical Issue: a flashing red LED light** on the charger indicates that battery pack has a charging problem or might be defective.

- One possible condition is the battery temperature is not within the charging temperature range of 23°F - 122°F or the charging current is too high. As soon as the permitted temperature and the charging current ranges are reached, the battery charger will automatically switch to charging.

- If the temperature range and charging current are correct and flashing red LED light continues, then remove and reinstall the battery pack. If the LED status repeats a second time, try to charge another identical battery. If the battery charges normally, dispose of the defective battery pack (see Environmentally Safe Battery Disposal section).

- If the flashing red light continues after installing the second battery, the charger may be defective. Replace with a new one.

■ After continuous or repeated charging cycles without interruption, the charger surface may become noticeably warm. This is normal and does not indicate a technical defect of the battery charger.

■ **Green LED flashing rapidly** indicates that the battery voltage is low, and that charging will only continue for about another 30 minutes.

⚠ WARNING! To avoid risk of fire, electric shock, or electrocution:





■ Do not use a damp cloth or detergent on the battery or battery charger.

■ Always remove the battery pack before cleaning, inspecting, or performing any maintenance on the product.

BATTERY LED INDICATORS

Check the battery pack capacity by pressing the LED button.

When the LED button is pressed, the number of illuminated lights indicates the state of battery pack capacity. See Table below.

NUMBER of LIGHTED LEDs	CAPACITY
	0%-25%
	25%-50%
	50%-75%
	75%-100%

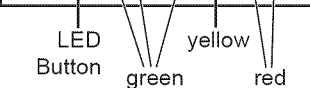

 LED Button green yellow red

SAFETY NOTES AND PRECAUTIONS

- Do not disassemble the battery.
- Keep away from children.
- Do not expose the battery to water or salt water. You should place the battery in a cool and dry environment.
- Do not place the battery in high-temperature locations, such as fire or heater.
- Do not reverse the positive terminal and the negative terminal of the battery.
- Do not connect the positive terminal and the negative terminal of the battery to each other with any metal objects.
- Do not knock or strike the battery, nor step on it.
- Do not solder directly onto the battery or pierce the battery with nails or other edge tools.
- In the event that battery leaks and fluid gets into your eyes, do not rub the eyes. Rinse well with water. Immediately discontinue use of the battery if it emits an unusual smell, feels hot, changes color, changes shape, or appears abnormal in any other way.

OPERATION

⚠ WARNING! Do not allow familiarity with products to make you careless. Remember that a careless fraction of a second is sufficient to inflict serious injury.

⚠ WARNING! Always wear eye protection with side shields marked to comply with ANSI Z87.1, along with head protection. Failure to do so could result in objects being thrown into your eyes and other possible serious injuries.

⚠ WARNING! Do not use any attachments or accessories not recommended by the manufacturer or retailer of this product. The use of attachments or accessories not recommended can result in serious personal injury.

Before each use, inspect the entire product for damaged, missing, or loose parts such as screws, nuts, bolts, caps, etc. Tighten securely all fasteners and caps and do not operate this product until all missing or damaged parts are replaced.

APPLICATIONS

You may use this product for the purposes listed below:

- Limbing and pruning branches from trees.
- Felling small trees up to 9 inch diameter.
- Bucking the fallen tree into shorter lengths

NOTE: For complete charging instructions, refer to the OPERATOR'S MANUAL for your battery pack and charger.

TO INSTALL / REMOVE BATTERY PACK

See Figure 7, page iii

⚠ WARNING! Always remove battery pack from your tool when you are assembling parts, making adjustments, cleaning, carrying, transporting or when not in use. Removing battery pack will prevent accidental starting that could cause serious personal injury.

NOTE: To avoid serious personal injury, always remove the battery pack and keep hands clear of the safety switch when carrying or transporting the tool.

TO INSTALL:

- Align the tongue of the battery pack with the cavity in the chainsaw.
- Grasp the chainsaw firmly.
- Push the battery pack into the chainsaw until the latch locks into place.
- Do not use force when inserting the battery pack. It should slide into position and “click”.

TO REMOVE:

- Press the release button on the battery pack to release the battery pack from the chainsaw.
- Grasp the chainsaw firmly, and pull the battery pack out.

CHAIN OIL SYSTEM

See Figure 8, page iii

Check and fill the oil tank when battery is recharged, or as needed.

CAUTION: Remove battery pack from unit before checking and filling oil reservoir. Fill oil tank with Craftsman Bar and Chain Oil before starting the chainsaw. Failure to lubricate the chain will cause damage to the bar and chain.

NOTE: BAR & CHAIN OIL NOT INCLUDED. BAR & CHAIN OIL MUST BE ADDED PRIOR TO USE.

- Use standard Craftsman chainsaw bar and chain oil. It is designed for chains and chain oilers, and is formulated to perform over a wide temperature range with no dilution required.

OPERATION

NOTE: Do not use dirty, used or otherwise contaminated oils. Damage may occur to the bar or chain.

- Remove oil reservoir cap.
- Carefully pour the bar and chain oil into the reservoir.
- Wipe off excess oil from around the reservoir.

NOTE: It is normal for oil to seep from the saw when not in use. To prevent seepage, empty the oil tank after each use. When storing the unit for a long period of time (three months or longer) be sure the chain is lightly lubricated; this will prevent rust on the chain and bar sprocket.

STARTING AND STOPPING THE CHAINSAW

See Figure 9, page iii

WARNING! Keep body to the left of the chain line. Never straddle the saw or chain, or lean over past the chain line.

NOTE: Carefully remove the scabbard from the bar before starting the chainsaw and place scabbard over the bar when chainsaw is not in use.

STARTING THE CHAINSAW

- Make sure chain tension is at desired setting. Refer to SAW CHAIN TENSIONING in the CARE AND MAINTENANCE section of this manual.
- Make sure no objects or obstructions are in immediate vicinity which could come into contact with the bar and chain.
- Press and hold the safety switch. This makes the trigger switch operational.
- Press and hold the trigger switch, release the safety switch, and continue to squeeze the trigger switch for continued operation.

STOPPING THE CHAINSAW

NOTE: It is normal for the chain to coast to a stop once the trigger switch is released.

WARNING! NEVER touch the chain while it is moving. Even a slowly moving chain can cause serious personal injury if touched.

- Release the trigger switch to stop the chainsaw.
- Upon release of the trigger switch, the safety switch will be automatically reset to the lock position.

NOTE: This cordless chainsaw is not designed for cutting trees larger than 9 inch in diameter.

This cordless chainsaw is designed for limbing and pruning type cutting, as well as cutting trees up to 9 inch in diameter only.

PROPER GRIP ON HANDLES

See Figures 10-11, page iv

- See GENERAL SAFETY INSTRUCTIONS for appropriate safety equipment.
- Wear non-slip gloves for maximum grip and protection.
- Hold the saw firmly with both hands. Always keep your left hand on the front handle and your right hand on the rear handle so that your body is to the left of the chain line.
- Maintain a proper grip on the saw whenever the motor is running. The fingers should encircle the handle, with the thumb wrapped under the handlebar. This grip is least likely to be broken by a kickback or other sudden reaction of the saw. Any grip in which the thumb and fingers are on the same side of the handle is dangerous, because a slight kick of the saw can cause loss of control.

WARNING! Never use a left-handed (cross-handed) grip or any stance that would place your body or arm across the chain line.

WARNING! DO NOT operate the trigger switch with your left hand and hold the front handle with your right hand. Never allow any part of your body to be in the chain line while operating a saw. (Fig.11)

OPERATION

PROPER CUTTING STANCE

See Figure 12, page iv

- Balance your weight with both feet on solid ground.
- Keep left arm with elbow locked in a “straight arm” position to withstand any kickback force.
- Keep your body to the left of the chain line.
- Keep your thumb on underside of handle bar.

BASIC OPERATING/CUTTING PROCEDURES

- Practice cutting a few small logs using the following technique to get the “feel” of using the saw before you begin a major sawing operation.
- Take the proper stance in front of the wood with the saw idling.
- Press the safety switch and squeeze the trigger switch, then release safety switch and let the chain accelerate to full speed before entering the cut.
- Begin cutting with the saw against the log.
- Keep the unit running the entire time you are cutting, maintain a steady speed.
- Allow the chain to cut for you; exert only light downward pressure.
- Forcing the cut could result in damage to the bar, chain, or motor.
- Release the trigger switch as soon as the cut is completed, allowing the chain to stop. If you run the saw without a cutting load, unnecessary wear can occur to the chain, bar, and unit.
- Do not put pressure on the saw at the end of the cut.

WORK AREA PRECAUTIONS

See Figure 13, page v

- Cut only wood or materials made from wood; no sheet metal, no plastics, no masonry, no non-wooden building materials.
- Never allow children to operate the saw. Allow no person to use this chainsaw who has not read this OPERATOR'S MANUAL or received adequate instructions for the safe and proper use of this chainsaw.

- Keep everyone - helpers, bystanders, children, and animals - a SAFE DISTANCE from the cutting area. During felling operations, the safe distance should be at least twice the height of the largest trees in the felling area. During bucking operations, keep a minimum distance of 15 ft. (4.6 m) between workers.
- Always cut with both feet on solid ground to prevent being pulled off balance.
- Do not cut above chest height, because a saw held higher is difficult to control against kickback forces.
- Do not fell trees near electrical wires or buildings. Leave this operation for professionals.
- Cut only when visibility and light are adequate for you to see clearly.

HAZARDOUS CONDITIONS IN TREE FELLING

See Figures 14a-14b, page v

When felling a tree, it is important that you heed the following instructions and warnings to prevent possible serious injury:

TO AVOID KICKBACK

- Saw with guide bar at a flat angle.
- Never work with a loose, widely stretched or the heavily worn out chain.
- Ensure chain is sharpened correctly.
- Never saw with the tip of the guide bar.
- Always hold the product firmly with both hands.
- Always use a low kickback chain.
- Ensure correct chain tension.
- Only cut with the motor at high speeds.
- Do not let the nose of the guide bar contact a log, branch, or any other obstruction which could be hit while you are operating the product.
- Follow the chain sharpening and maintenance instructions in the CARE AND MAINTENANCE section of this manual.
- Only replace the guide bar and saw chain with the identical parts as specified in the Parts List of this manual.

OPERATION

⚠ WARNING! Do not cut down trees having an extreme lean or large trees with rotten limbs, loose bark or hollow trunks. Have these trees pushed or dragged down with heavy equipment, then cut them up.

⚠ DANGER! Electrocutation hazard. Do not cut trees or branches near power lines or electrical wires. Contact with power lines or live electrical wires will result in serious personal injury or death.

⚠ WARNING! Do not cut trees or branches near buildings, which may result in serious injuries or property damage.

⚠ WARNING! Check the tree for damaged or dead branches that could fall and hit you during felling.

⚠ WARNING! Periodically glance at the top of the tree during the back cut to assure the tree is going to fall in the desired direction.

⚠ WARNING! If the tree starts to fall in the wrong direction, or if the saw gets caught or hung up during the fall, leave the saw and save yourself!

⚠ WARNING! Do not fell trees during periods of high wind or heavy precipitation. Wait until the hazardous weather has ended.

PROPER PROCEDURE FOR TREE FELLING

See Figures 15a-15c, page vi

■ Felling a tree - When bucking and felling operations are being performed by two or more persons at the same time, the felling operation should be separated from the bucking operation by a distance of at least twice the height of the tree being felled. Trees should not be felled in a manner that would endanger any person, strike any utility line, or

cause any property damage. If the tree does make contact with any utility line, the utility company should be notified immediately.

■ Operator should keep on the uphill side of terrain as the tree is likely to roll or slide after it is felled.

■ Plan and clear an escape path before starting to cut. The escape path should extend back and diagonally to the rear of the expected line of fall. (See Fig. 15a) Make sure there are no obstructions in your planned path of retreat. Clear a path of safe retreat from a point approximately 135° to the planned line of fall on each side of the tree. (See Fig. 14b)

■ Before felling is started, consider the natural lean of the tree, the location of larger branches and the wind direction to judge which way the tree will fall.

NOTCHING UNDERCUT

■ Make the notch 1/3 the diameter of the tree, perpendicular to the direction of fall. (Fig. 15b) Make the lower horizontal notching cut (A) first. This will help to avoid pinching either the saw chain or the guide bar when the upper angled second notching cut (B) is being made.

FELLING BACK CUT

■ Make the felling back cut (C) at least 2 inches (50 mm) higher than the horizontal notching cut. (Fig. 15b) Keep the felling back cut parallel to the horizontal notching cut. Make the felling back cut so enough wood is left to act as a hinge (D). The hinge wood keeps the tree from twisting and falling in the wrong direction. Do not cut through the hinge.

WARNING! Never cut through to the notch when making a back cut. The hinge controls the fall of the tree. This is the section of wood between the notch and back cut.

■ As the felling back cut gets close to the hinge, the tree should begin to fall. If there is any chance that the tree may not fall in

OPERATION

desired direction or that it may rock back and bind the saw chain, stop cutting and insert wedges in the cut (Fig. 15c) so as to open it wider and drop the tree in the desired line of fall.

- When the tree begins to fall, remove the chain bar from the cut, stop the chainsaw motor, put the chainsaw down, and move away from the tree along the planned retreat path. Be alert for overhead limbs falling and watch your footing.

- Limbing is removing the branches from a fallen tree. When limbing leave larger lower limbs to support the log off the ground. Remove the small limbs in one cut. (Fig. 15d) Branches under tension should be cut from the bottom up to avoid binding the chain bar.

REMOVING BUTTRESS ROOTS

See Figure 16, page vi

A buttress root is a large root extending from the trunk of the tree above the ground. Saw through the buttress root with a vertical cut. Remove the resulting loose section from the work area. Follow the correct tree felling procedure as stated in Proper Procedure for Tree Felling after you have removed the large buttress roots.

BUCKING

See Figure 17, page vi

Bucking is the term used for cutting a fallen tree to the desired log length.

- Always make sure your footing is secure and your weight is distributed evenly on both feet.
- Cut only one log at a time.
- Support small logs on a saw horse or another log while bucking.
- Keep a clear cutting area. Make sure no objects can contact the guide bar nose and chain during cutting, because this can cause kickback.

- When bucking on a slope, always stand on the uphill side of the log. To maintain complete control of the chainsaw when cutting through the log, release the cutting pressure near the end of the cut without relaxing your grip on the chainsaw handles. Do not let the chain contact the ground. After completing the cut, wait for the saw chain to stop before you move the chainsaw. Always stop the motor before moving from tree to tree.

BUCKING WITH A WEDGE

See Figure 18, page vi

If the wood diameter is large enough for you to insert a bucking wedge without touching the chain, you should use the wedge to hold the cut open to prevent pinching.

OVERBUCKING

See Figure 20, page vii

Begin on the top side of the log with the bottom of the saw against the log; exert light pressure downward. Note that the saw will tend to pull away from you.

UNDERBUCKING

See Figure 21, page vii

Begin on the under side of the log with the top of the saw against the log; exert light pressure upward. During under bucking, the saw will tend to push back at you. Be prepared for this reaction, and hold the saw firmly to maintain control.

BUCKING LOGS UNDER STRESS

See Figure 19, page vi

Make the first bucking cut 1/3 of the way through the log, and finish with a 2/3 cut on the opposite side. As you cut the log, it will tend to bend. The saw can become pinched or hung in the log if you make the first cut deeper than 1/3 of the diameter of the log. Give special attention to logs under stress to prevent the bar and chain from pinching.

OPERATION

LIMBING

See Figure 23, page vii

Limbing is removing branches from a fallen tree.

- Work slowly, keeping both hands on the chainsaw with a firm grip. Always make sure your footing is secure and your weight is distributed evenly on both feet.
- Leave the larger support limbs under the tree to keep the tree off the ground while cutting.
- Limbs should be cut one at a time. Remove the cut limbs from the work area often to help keep the work area clean and safe.
- Support limbs are under tension. Underbuck (cut from bottom up) support limbs to avoid binding the saw blade.
- **WARNING!** While limbing, stand on the other side of the tree from the limb you are cutting (Fig. 23) to stay out of the way of the falling cut limb.

PRUNING

See Figure 22, page vii

Pruning is trimming limbs from a live tree.

- Work slowly, keeping both hands on the chainsaw with a firm grip. Always make sure your footing is secure and your weight is distributed evenly on both feet.
- **WARNING!** Do not cut from a ladder. This is extremely dangerous. Leave this operation for professionals.
- **WARNING!** Do not cut above chest height, because a saw held higher is difficult to control against kickback.
- When pruning trees, it is important not to make the finishing cut next to the main limb or trunk until you have cut off the limb further out to reduce the weight. This prevents stripping the bark from the main member.
- Underbuck the branch 1/3 through for your first cut.

- Your second cut should overbuck to drop the branch off.

- Now make your finishing cut smoothly and neatly against the main member so the bark will grow back to seal the wound.

CUTTING SPRINGPOLES

See Figure 24, page vii

A springpole is any log, branch, rooted stump, or sapling that is bent under tension by other wood, so that it springs back if the wood holding it is cut or removed. On a fallen tree, a rooted stump has a high potential of springing back to the upright position during the bucking cut to separate the log from the stump. Watch out for springpoles - they are dangerous.

- ▲ **WARNING!** Springpoles are dangerous, and could strike the operator, causing the operator to lose control of the chainsaw. This could result in severe or fatal injury to the operator.

CARE AND MAINTENANCE

 **WARNING!** When servicing, use only identical replacement parts. Use of any other parts may create a hazard or cause product damage.

 **WARNING!** Always wear eye protection with side shields marked to comply with ANSI Z87.1, along with hearing protection. Failure to do so could result in objects being thrown into your eyes resulting in possible serious injuries. If operation is dusty, also wear breathing protection.

 **WARNING!** To avoid serious personal injury, always remove the battery pack from the tool when cleaning or performing any maintenance.

GENERAL MAINTENANCE

Avoid using solvents when cleaning plastic parts. Most plastics are susceptible to damage from various types of commercial solvents and may be damaged by their use. Use clean cloths to remove dirt, dust, oil, grease, etc.

 **WARNING!** Do not at any time let brake fluids, gasoline, petroleum-based products, penetrating oils, etc., come in contact with plastic parts. Chemicals can damage, weaken or destroy plastic which may result in serious personal injury.

Remove the scabbard when user is performing any maintenance or cleaning. Always place scabbard over the bar when chainsaw is not in use.

BATTERY PACK

- Store the battery pack fully charged.
- Recharge the battery pack whenever there is a noticeable reduction in chainsaw performance. Do not allow the battery pack to become completely discharged.

■ Do not recharge a battery pack that is already fully charged. Overcharging shortens battery life.

■ Once the battery pack is fully charged, remove the battery from the charger and disconnect the charger from the outlet.

■ Do not store the battery pack on the tool or in the charger.

■ Recharge the battery at a temperature between 23°F and 122°F. If the battery pack is hot, allow it to cool down before recharging.

CHARGER MAINTENANCE

■ Keep the charger clean and clear of debris. Do not allow foreign material to get into the recessed cavity or onto the contacts. Wipe the charger clean with a dry cloth. Do not use solvents or water, and do not place the charger in wet conditions.

■ Unplug the charger when there is no battery pack in it.

■ Keep the charger stored in normal room temperature. Do not store it in excessive heat. Do not use in direct sunlight.

LUBRICATION

All of the motor bearings in this product are lubricated with a sufficient amount of high-grade oil for the life of the unit under normal operating conditions. Therefore, no further lubrication is required.

CHAINSAW CARE

Switch the chainsaw off, remove the battery pack and let it cool down.

Check, clean and store the chainsaw as described below.

Keep the chainsaw clean. Remove debris from it after each use and before storage.

Regular and proper cleaning will help ensure safe use and prolong the life of the chainsaw.

Inspect the chainsaw before each use for worn and damaged parts.

Do not operate chainsaw if you find broken and worn parts.

CARE AND MAINTENANCE

GENERAL CLEANING

Clean the product with a slightly damp cloth and mild soap. Use a brush for areas that are hard to reach.

In particular clean the air vents after every use with a cloth and brush.

Remove stubborn dirt with high pressure air (max. 3 bar).

Check for damaged or worn parts. Replace damaged or worn parts before further chain saw use. Only use identical replacement parts as listed in the Parts List in this manual.

BAR NOSE

Clean the bar nose. Using a disposable lube gun, insert the applicator into the lubrication hole and inject grease until it appears at the outside edge of the bar nose sprocket. (Fig. 25)

Rotate the saw chain by hand. Repeat the lubrication procedure until the entire bar nose sprocket has been greased.

GUIDE BAR AND SAW CHAIN MAINTENANCE

Most guide bar problems can be prevented merely by keeping the chainsaw well maintained. Incorrect filing and non-standard cutter and depth gauge settings are the causes of most guide bar problems, primarily resulting in uneven bar wear. As the bar wears unevenly, the rails widen, which may cause the chain to clatter and make it difficult to complete straight cuts. If the guide bar is insufficiently lubricated and the chainsaw is operated with a chain which is too tight, the bar will wear rapidly. To help minimize bar wear, maintenance of the guide bar as well as the saw chain is recommended.

Check the oiling port (see Fig. 4) for clogging and clean if necessary to ensure proper lubrication of the guide bar and saw chain during operation. Use a soft wire small enough to insert into the oil discharge hole.

REMOVING THE GUIDE BAR AND CHAIN
See Figure 26, page viii ; Figure 33, page ix

 **WARNING!** To avoid serious personal injury, read and understand all the safety instructions in this section.

 **WARNING!** Before performing any maintenance, remove the battery pack from the tool. Failure to heed this warning could result in serious personal injury.

 **CAUTION!** Always wear gloves when handling the bar and chain. These components are sharp and may contain burrs.

 **WARNING!** Never touch or adjust the chain while the motor is running. The saw chain is very sharp. Always wear protective gloves when performing maintenance involving the chain to avoid possible serious lacerations.

 **WARNING!** Always hold the chainsaw with your right hand on the rear handle and your left hand on the front handle. Holding the chainsaw with a reversed hand configuration increases the risk of personal injury and should never be done.

- Place the chainsaw on a suitable flat surface.
- Loosen the lock knob and remove the chain cover. (Fig. 26)
- Remove bar and chain assembly from support bolt. (Fig. 33)

CARE AND MAINTENANCE

REPLACING THE GUIDE BAR AND CHAIN

See Figures 26-39, page viii-x

 **DANGER!** Never start the motor before installing the guide bar, chain, chain cover, and chain cover lock knob. Without all these parts in place, the clutch can fly off or explode, exposing the user to possible serious injury.

 **WARNING!** Keep all parts of the body away from the chainsaw when the chainsaw is operating. Before you start the chainsaw, make sure the chainsaw is not contacting anything.

A moment of inattention while operating chainsaws may cause entanglement of your clothing or body with the saw chain.

 **WARNING!** Always use a saw chain designated as “low-kickback” or a saw chain which meets the low-kickback requirements! A standard saw chain (a chain which does not have the kickback reducing guard links) should only be used by an experienced professional operator! Nevertheless, a low-kickback saw chain does not completely eliminate kickback! A low-kickback or “safety” chain should never be regarded as complete protection against injury! Therefore always use a low-kickback saw chain in conjunction with other kickback protection devices such as the front hand guard!

- Use only a guide bar and saw chain as listed in the Product Specifications of this manual.
- Lay the saw chain into the groove of the bar with the cutting edges of the chain pointing in the rotational direction shown on the bar. (Fig. 27)
- Ensure that the guide bar tension disc is adjusted to the outermost position away from the bar; turn the disc counterclockwise if required. (Figs. 31-32)
- Lay the saw chain around the drive sprocket, and lay the guide bar against the

saw body so that the support bolt protrudes through the hole in the guide bar tension disc. (Figs. 33-34)

- Replace the chain cover and slightly tighten the lock knob. (Fig. 35)
- Do not tighten the lock knob completely; saw chain tensioning is required first.
- Release the tip of the guide bar, and turn the chain tensioning knob 1/2 turn clockwise. (Fig. 35)
- Hold the tip of the guide bar up and fully tighten the chain cover lock knob.

The chain is correctly tensioned when there is no sag on the underside of the guide bar, and when the chain is snug it can be turned by hand without binding.

NOTE: If chain is too tight, it will not rotate. Loosen the chain cover lock knob slightly, and turn the chain tensioning knob 1/4 turn counterclockwise. Lift the tip of the guide bar up, and retighten the chain cover lock knob. Ensure that the chain will rotate without binding.

SAW CHAIN TENSIONING

 **WARNING!** Never touch or adjust the chain while the motor is running. The saw chain is very sharp. Always wear protective gloves when performing maintenance involving the chain.

- Always check the saw chain tension before use and regularly during use (approximately every five cuts).
- Upon initial operation, new chains can lengthen considerably. This is normal during the break-in period and the interval between future adjustments will lengthen quickly.
- To tension chain, first set the the chainsaw on a suitable flat surface.
- Turn the tensioning knob until the chain “tie straps” are just touching the bottom edge of the guide bar. (Fig. 28)

CARE AND MAINTENANCE

TENSION TEST

- Check the chain tension by using one hand to lift the chain above the edge of the bar. The tension is correct when the chain lifts so that the tie straps are approximately 3/32 - 5/32 in. (2 - 4 mm) above the bar edge. (Figs. 29-30)
- Adjust the tension if you find that the chainsaw is too loose or tight. Turn the chain tensioning knob clockwise to tighten and counterclockwise to loosen the chain tension.

NOTE: A cold chain is correctly tensioned when there is no slack on the underside of the guide bar, the chain is snug, and it can be turned by hand without binding.

- Rotate the chain cover lock knob clockwise to secure. Retension the chain whenever the flats on the drive links hang out of the bar groove.

NOTE: During normal saw operation, the temperature of the chain increases. The drive links of a correctly tensioned warm chain will hang approximately 1/16 in. (1.3 mm) out of the bar groove.

NOTE: New chains tend to stretch. Check the chain tension frequently and tension as required.

 **CAUTION!** A chain tensioned while warm may be too tight upon cooling. Check the “cold tension” before next use.

CHECKING OIL LEVEL

- Check the oil level at the window of the oil tank (Quick View Oil Indicator) prior to switching on and regularly during operation. Refill oil when the oil level is lower than the “MIN” marking. (Fig. 42)
- Do not overfill. Leave approximately 1/5 inch of space to the lower edge to allow the oil to expand. (Fig. 41)

- Wipe up spilled oil with a soft cloth and refill the tank cap.

- Make sure the guide bar and the saw chain are in place when you check the oil delivery.

- Switch on the product (see section “STARTING THE CHAINSAW”); keep pressing the trigger switch and check if the chain oil is delivered as shown in the figure. (Fig. 43)

CARE AND MAINTENANCE

- Check the drive sprocket. If it is worn or damaged due to strain, it must be replaced before further chainsaw use.

- Clear residue from the rails on the guide bar using a screwdriver, putty knife, wire brush or other similar tool. This will keep the oil passages open to provide proper lubrication to the bar and chain. (Fig. 44)

- Check the guide bar ‘rail’ for wear: Hold a ruler (straight edge) against the side of the guide bar and ‘cutter side plates’. If there is a gap between the ruler and guide bar the guide bar ‘rail’ is normal. If there is no gap (ruler flush against the side of the guide bar) the guide bar ‘rail’ is worn and needs to be replaced with a new one of the same type. (Fig. 45)

- Reverse the guide bar from time to time to allow for even wear, which will extend the life span of the bar. Loosen the screw and remove the tension disc from the guide bar.

Ensure the rubber washer on the screw is free of wear. Turn the guide bar and fix the tension disc with the screw. Apply a drop of suitable glue to the screw to ensure its safe positioning when reassembled. (Fig. 45a)

CARE AND MAINTENANCE

CHAIN MAINTENANCE

Know your saw chain (See Figure 46-47, page xi)

Use only a low-kickback chain on this saw (Fig. 47). This fast-cutting chain provides kickback reduction when properly maintained. For smooth and fast cutting, maintain the chain properly. The chain requires sharpening when the wood chips are small and powdery, the chain must be forced through the wood during cutting, or the chain cuts to one side. During maintenance of the chain, consider the following:

- Improper filing angle of the side plate (Fig.46) can increase the risk of severe kickback.
- Depth gauge setting. (Fig. 49).
- Edges worn too low increases the potential for kickback.
- Cutting edges not low enough decreases cutting ability.
- If the chain cutters hit hard objects such as nails and stones, or are abraded by mud or sand on the wood, take the saw to a qualified chainsaw service center to have the chain sharpened. Use only identical parts as listed in this manual.

NOTE: Inspect the drive sprocket for wear or damage when replacing the chain. If signs of wear or damage are present in the areas indicated, take the saw to a qualified chainsaw service center to have the sprocket replaced. Use only identical parts as listed in this manual.

Check the saw chain for possible wear and damages. Replace it with a new one if required. Experienced users can sharpen a dull saw chain (see section “Saw chain sharpening” below). Refit the saw chain and the guide bar as described in Replacing the Guide Bar and Chain section.

NOTE: If you do not fully understand the correct procedure for sharpening the chain after reading the instructions that follow, have the saw chain sharpened by a qualified chainsaw service center or replaced with a recommended low-kickback chain.

SAW CHAIN SHARPENING

Have your chain sharpened professionally at a qualified service center, or sharpen the chain yourself by using a proper sharpening kit. Also observe the sharpening instructions supplied with the sharpening kit.

The height difference between the cutting tip and the ridge is the depth gauge setting. (Fig. 49).

When sharpening the saw chain you have to consider the following points:

- File angle
- Cutting angle
- File position
- Diameter of round file
- File

TO SHARPEN THE CHAIN, PROCEED AS FOLLOWS:

- Use protective gloves.
- Ensure the chain is correctly tensioned on the guide bar.

Use a round file, whose diameter is 1.1 times the cutting tooth depth.

Make sure 20% of the file diameter is above the cutter's top plate.

A file guide is available from most reputable tool merchants and is the easiest way to hold the file at the correct position.

File at an angle perpendicular to the bar, and at an angle of 25° to the direction of travel. (Fig.48)

File each tooth from the inside towards outside only.

File one side of the chain first than turn the saw around and repeat the process.

Sharpen each tooth equally by using the same number of strokes.

Keep all cutter lengths equal (Fig. 49).

Check the depth gauge settings every 5 sharpenings. It is essential to keep the depth gauge settings at .025 inch (Fig. 49).

CARE AND MAINTENANCE

Use a depth gauge measuring instrument to check the height of the depth gauge setting.

Depth gauge measuring jigs are available from most tool merchants.

If the saw is not functioning properly, take it to a qualified chainsaw service center to have saw inspected for possible repair. Use only identical parts as listed in this manual.

STORAGE

Store the product and its accessories in a dry, frost-free place.

Always store the product in a place that is inaccessible to children. The ideal storage temperature is between 50°F and 80°F.

We recommend using the original package for storage or covering the product with a suitable cloth or enclosure to protect it against dust.

TRANSPORTATION

Switch the product off and remove the battery pack before transporting it anywhere.

Attach the blade cover to the saw blade.

Attach other transportation guards, if applicable.

Always carry the product by its gripping handles.

Protect the product from any heavy impact or strong vibrations which may occur during transportation in vehicles.

Secure the product to prevent it from slipping or falling over.

ENVIRONMENTALLY SAFE BATTERY DISPOSAL



The following toxic and corrosive materials are in the batteries used in this battery pack:

Lithium-Ion, a toxic material.



WARNING! All toxic materials must be disposed of in a specified manner to prevent contamination of the environment. Before disposing of damaged or worn out Lithium-Ion battery packs, contact your local waste disposal agency, or the local Environmental Protection Agency for information and specific instructions.



WARNING! If the battery pack cracks or breaks, with or without leaks, do not recharge it and do not use. Dispose of it and replace with a new battery pack.

DO NOT ATTEMPT TO REPAIR IT!

To avoid injury and risk of fire, explosion, or electric shock, and to avoid damage to the environment:

- Cover the battery terminals with heavy-duty adhesive tape.
- DO NOT attempt to remove or destroy any of the battery pack components.
- DO NOT attempt to open the battery pack.
- If a leak develops, the released electrolytes are corrosive and toxic. DO NOT get the solution in the eyes or on skin, and do not swallow it.
- DO NOT place these batteries in your regular household trash.
- DO NOT incinerate.
- DO NOT place batteries where they will become part of any waste landfill or municipal solid waste stream.
- Take batteries to a certified recycling or disposal center.

TROUBLESHOOTING

PROBLEM	POSSIBLE CAUSE	SOLUTION
Bar and chain running hot and smoking.	1. Check chain tension for over-tight condition.	1. Adjust the chain tension.
	2. Chain-oil tank empty.	2. Refill with the correct oil.
Motor runs, but chain is not rotating.	1. Chain tension too tight.	1. Retension chain, Refer to SAW CHAIN TENSIONING earlier in this manual.
	2. Check guide bar and chain assembly.	2. Refer to Replacing Bar and Chain earlier in this manual.
	3. Check guide bar and chain for damage.	3. Inspect guide bar and chain for damage.
Motor runs, chain rotates but does not cut.	1. Dull chain.	1. Sharpen chain.
	2. Chain on backwards.	2. Reverse direction of chain.

CRAFTSMAN 24V MAX* LITHIUM-ION CORDLESS CHAINSAW – MODEL NUMBER 151.74931

CRAFTSMAN 24V MAX* LITHIUM-ION CORDLESS CHAINSAW – MODEL NUMBER 151.74941

The model number will be found on a label attached to the motor housing.

TO PURCHASE REPLACEMENT PARTS, CALL 1-888-331-4569

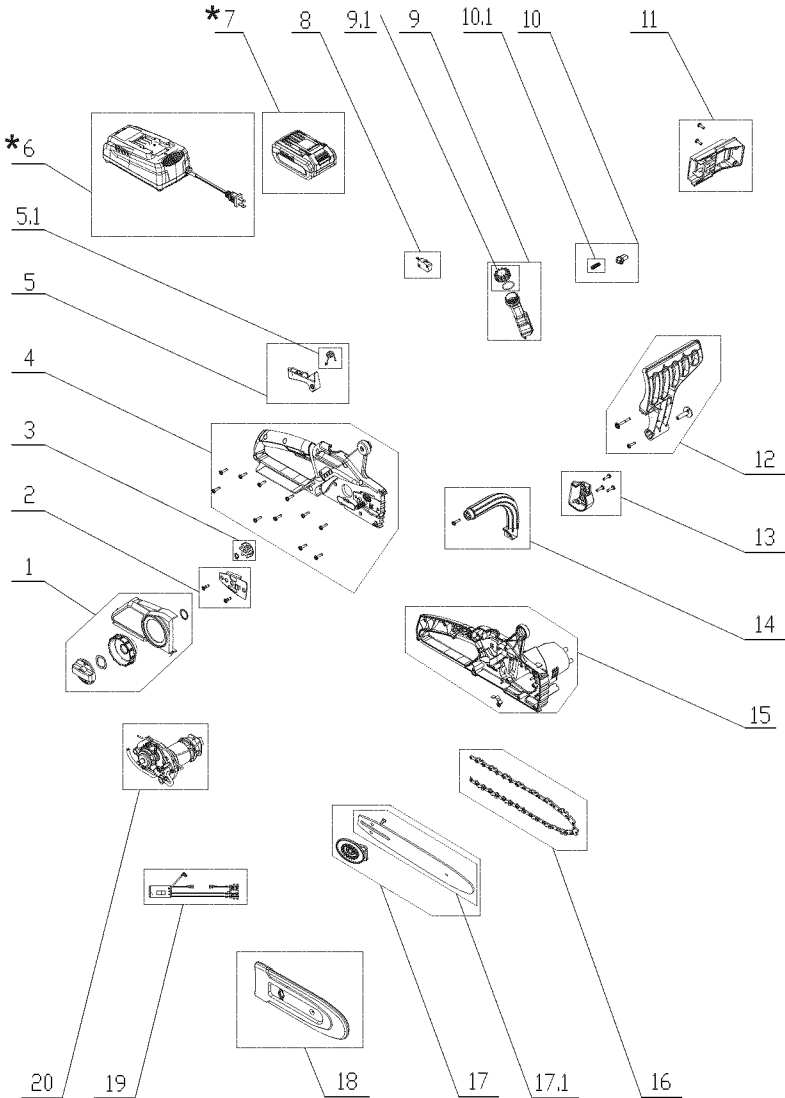

* - Parts #6 & #7 NOT INCLUDED in item # 151.74941

CRAFTSMAN 24V MAX* LITHIUM-ION CORDLESS CHAINSAW – MODEL NUMBER 151.74931

CRAFTSMAN 24V MAX* LITHIUM-ION CORDLESS CHAINSAW – MODEL NUMBER 151.74941

The model number will be found on a label attached to the motor housing.

TO PURCHASE REPLACEMENT PARTS, CALL 1-888-331-4569

ITEM NO.	PART NO.	DESCRIPTION	QTY
1	261004101	Tool-Free Housing Assembly	1
2	261001120	Guide Plate Assembly	1
3	261001121	Chain Wheel Assembly	1
4	261004102	Right Motor Housing Assembly	1
5	261004103	Trigger Assembly	1
5.1	261001105	Trigger Spring	1
6	24LFC14-ETL	24V Lithium-Ion Battery Charger (24LFC14-ETL) * (NOT INCLUDED in item # 151.74941)	1
7	71.98724	24V Lithium-Ion Battery (24LB2513) * (NOT INCLUDED in item # 151.74941)	1
8	241003110	Switch	1
9	261004104	Oil Reservoir Assembly	1
9.1	261004105	Oil Reservoir Cap	1
10	261004106	Safety Switch Assembly	1
10.1	261001107	Safety Switch Spring	1
11	261004107	Battery Bracket Assembly	1
12	261004108	Chain Guard Assembly	1
13	261004109	Motor Housing Cover Assembly	1
14	261004110	Assist Handle Assembly	1
15	261004111	Left Motor Housing Assembly	1
16	261001116	Chain	1
17	261004112	Guide Bar with Tensioning Sprocket	1
17.1	261004115	Guide Bar	1
18	261001117	Scabbard	1
19	261004113	PCB Board	1
20	261004114	Motor Assembly	1

* - Parts #6 & #7 NOT INCLUDED in item # 151.74941

See this section for all of the figures referenced in the operator's manual.

Fig. 1

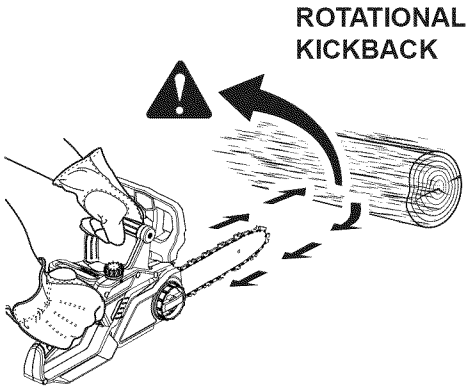

Fig. 2

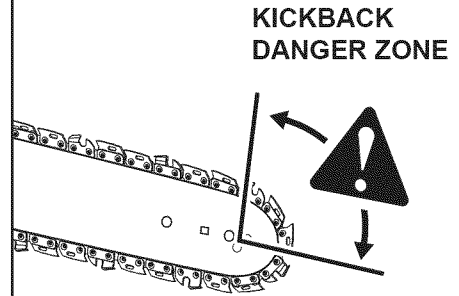

Fig. 3

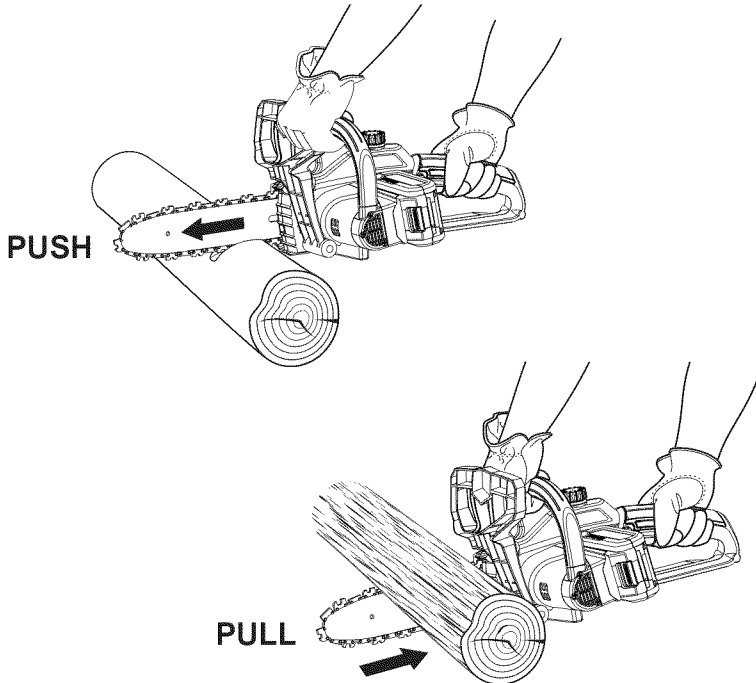
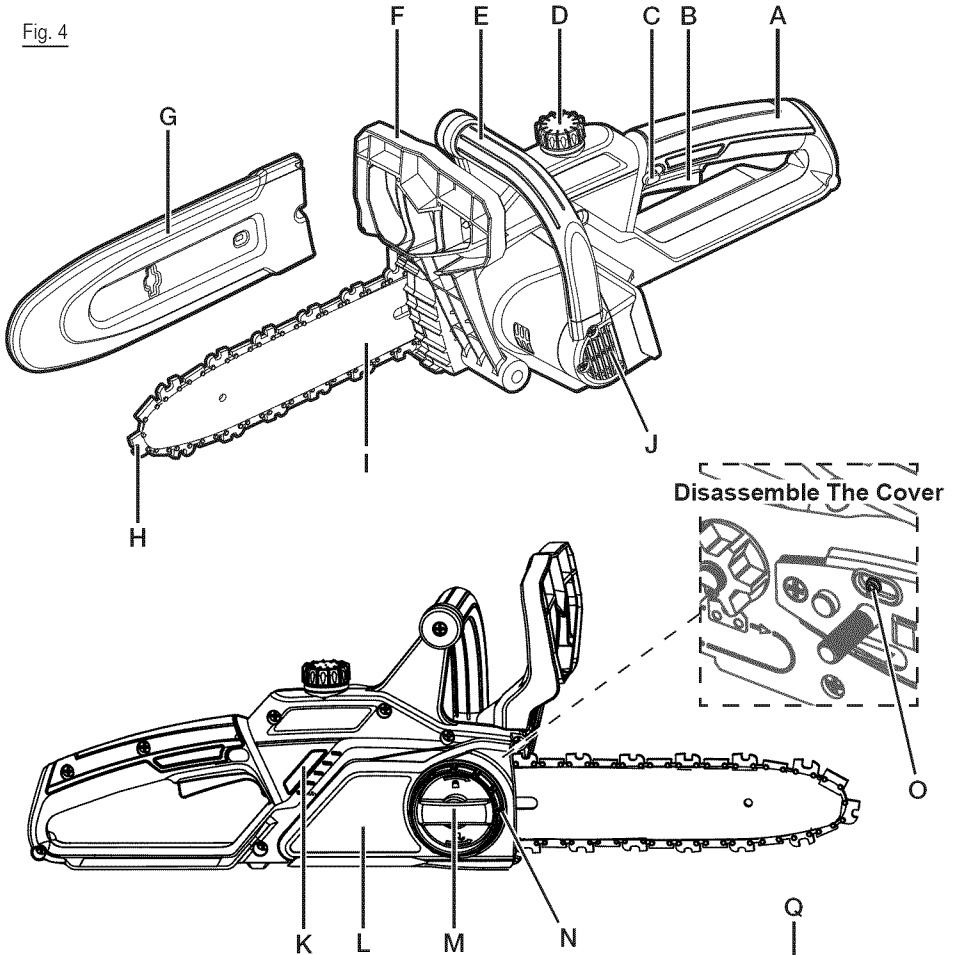

Fig. 4



- A - Rear Handle
- B - Trigger Switch
- C - Safety Switch
- D - Oil Reservoir Cap
- E - Front Hand
- F - Front Hand Guard
- G - Reusable Scabbard
- H - Low Kickback Saw Chain
- I - Guide Bar

- J - Motor Housing Cover
- K - Quick View Oil Indicator
- L - Chain Cover
- M - Chain Cover Lock Knob
- N - Chain Tensioning Knob

- O - Oiling Port
- P - Battery Charger
- Q - 24V max*, 2.5 Ah Lithium-Ion Battery

Fig. 5

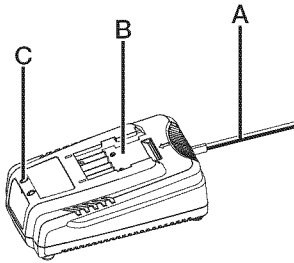

- A - Power Cord with Plug
- B - Charger
- C - Indicator Lights

Fig. 6

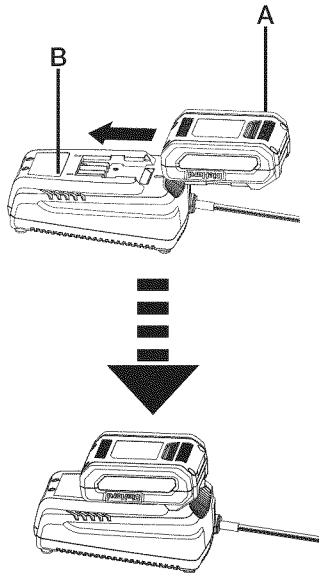

- A - Battery
- B - Charger

Fig. 7

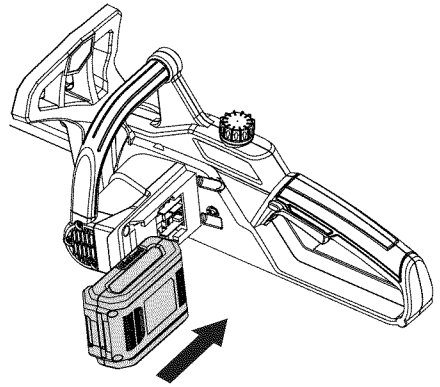
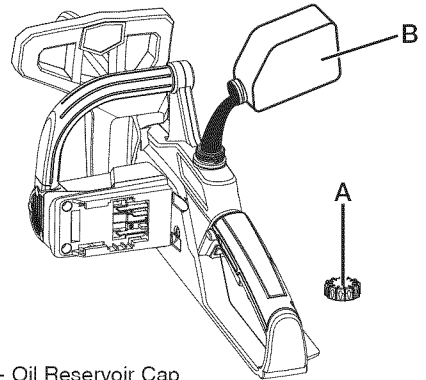
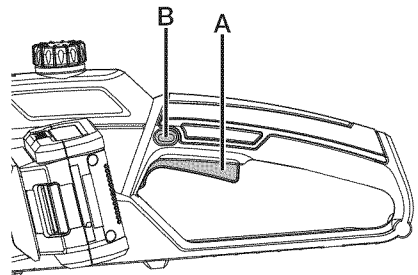

Fig. 8



- A - Oil Reservoir Cap
- B - Bar & Chain Oil

Fig. 9



- A - Trigger Switch
- B - Safety Switch

Fig. 10

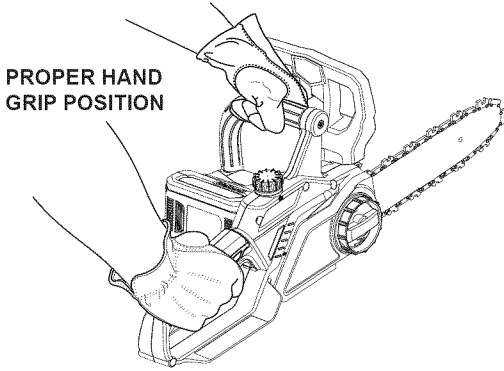

Fig. 11

WRONG OPERATION POSITION

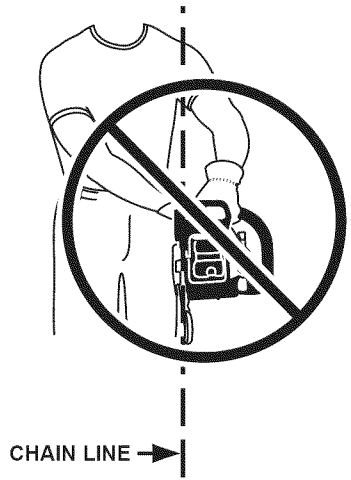

Fig. 12

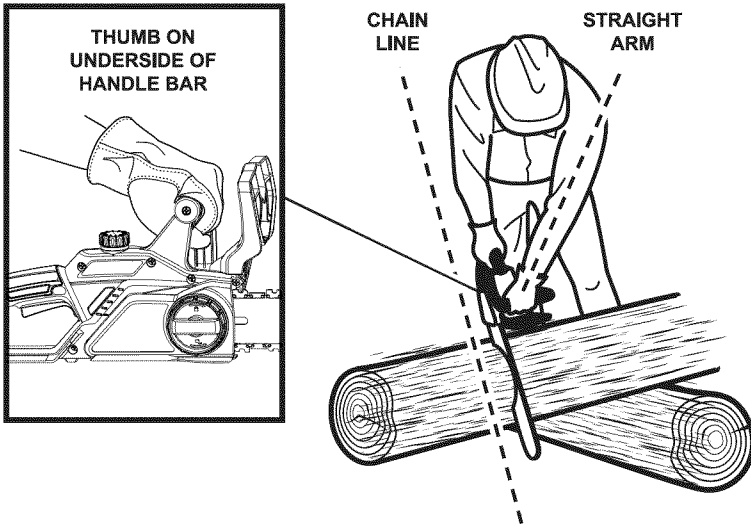

Fig. 13



Fig. 14a

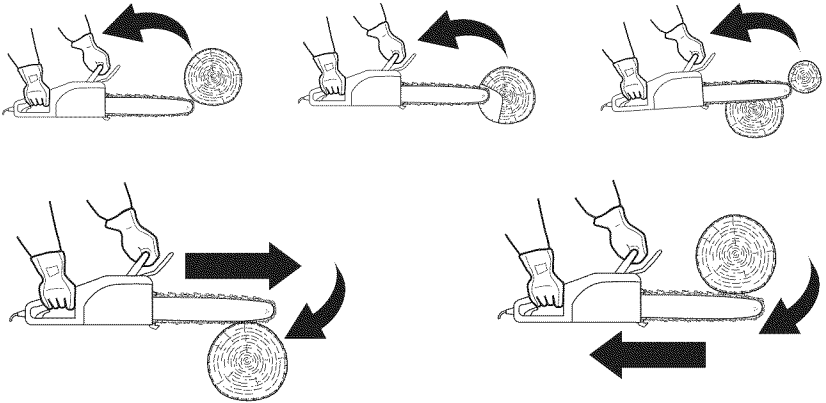

Fig. 14b

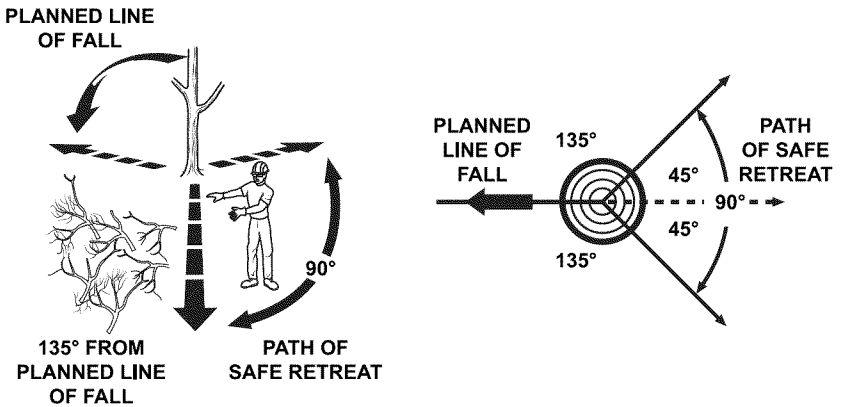

Fig. 15a

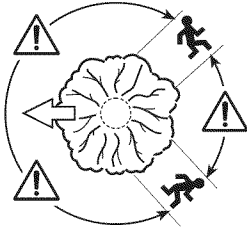

Fig. 15b

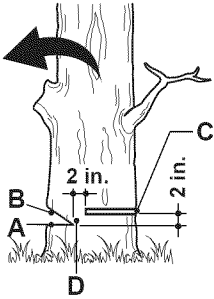
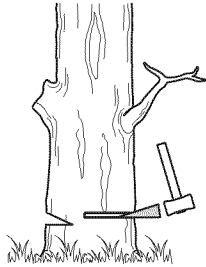

Fig. 15c



- A - Lower Horizontal Notch Cut
- B - Upper Angled Notch Cut
- C - Felling Back Cut
- D - Hinge

Fig. 15d

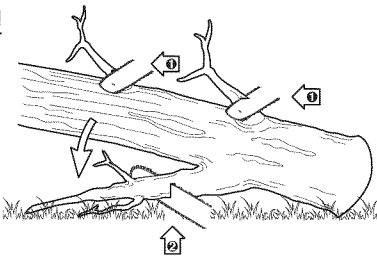

Fig. 16

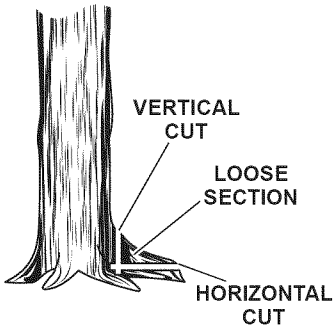

Fig. 17

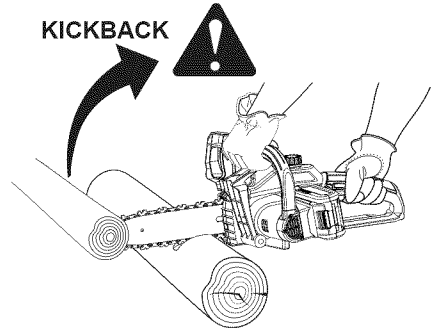

Fig. 18

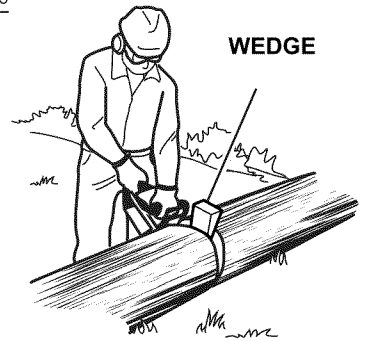
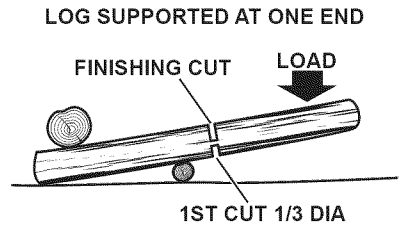

Fig. 19



LOG SUPPORTED AT BOTH ENDS

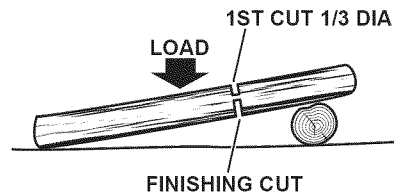

Fig. 20

OVERBUCKING

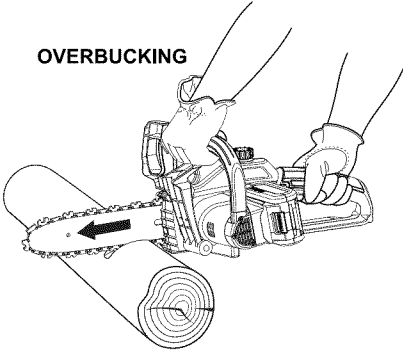

Fig. 21

UNDERBUCKING

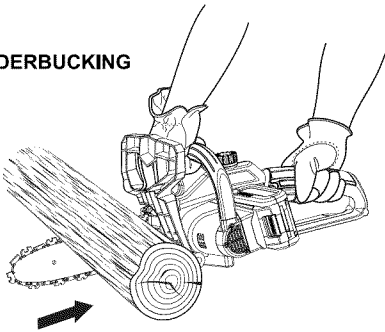

Fig. 22

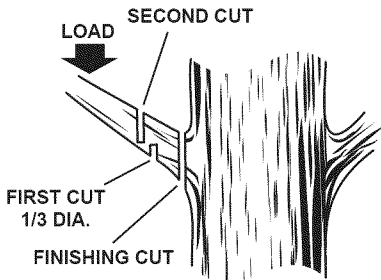
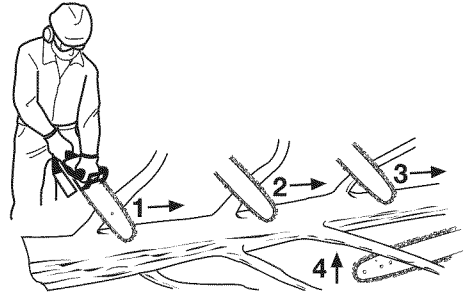

Fig. 23



**CUT LIMBS ONE AT A TIME.
LEAVE SUPPORT LIMBS UNDER
TREE TO RAISE OFF GROUND.
CUT TOP LIMBS FIRST.
UNDERBUCK SUPPORT LIMBS.**

Fig. 24

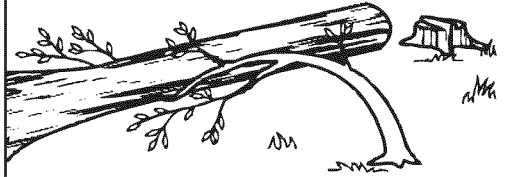
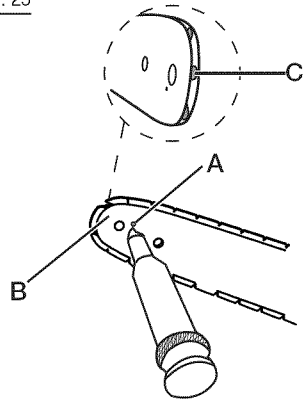
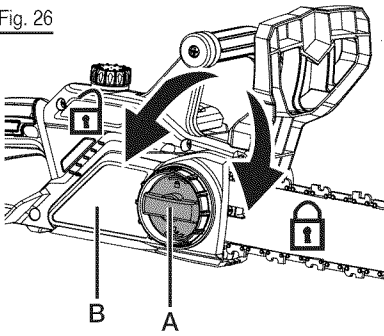

Fig. 25



A - Lubrication Hole
B - Bar Nose
C - Sprocket

Fig. 26



A - Lock Knob
B - Chain Cover

Fig. 27

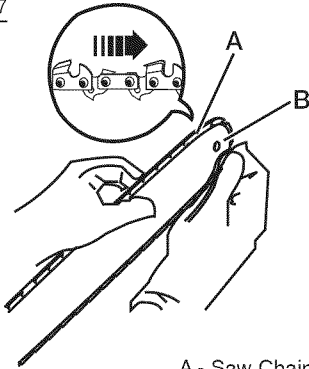

A - Saw Chain
B - Guide Bar

Fig. 28

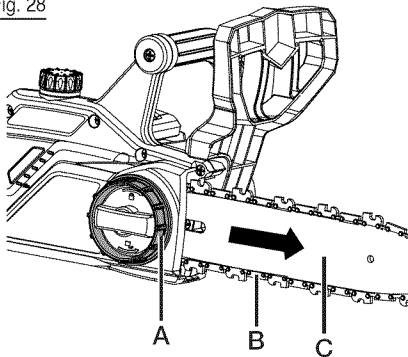

A - Chain Tensioning Knob
B - Tie Strap
C - Guide Bar

Fig. 29

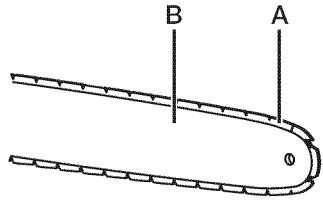

A - Saw Chain
B - Guide Bar

Fig. 30

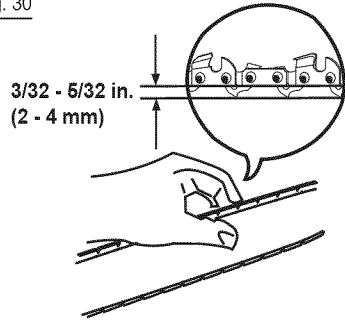

Fig. 31

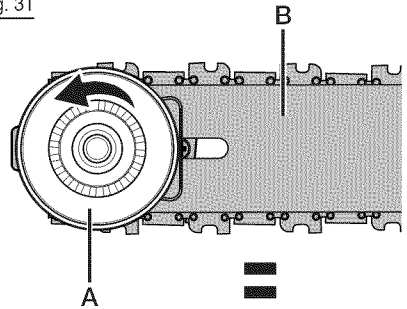
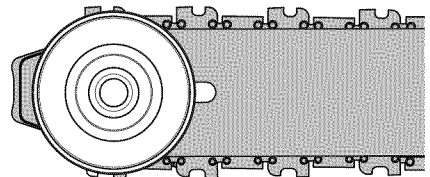
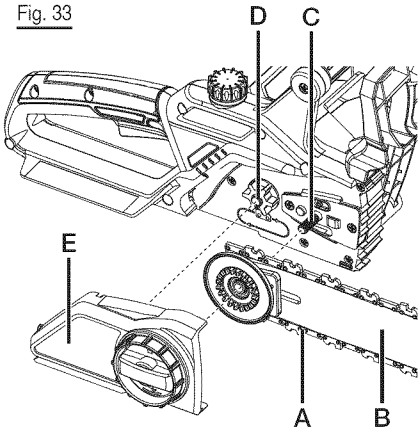

Fig. 32



A - Tension Disc
B - Guide Bar

Fig. 33



- A - Saw Chain
- B - Guide Bar
- C - Support Bolt
- D - Drive Sprocket
- E - Chain Cover

Fig. 34

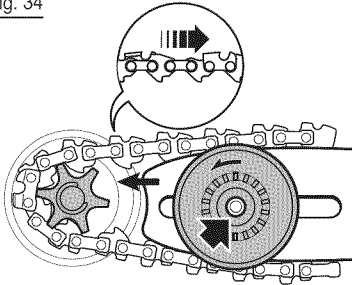
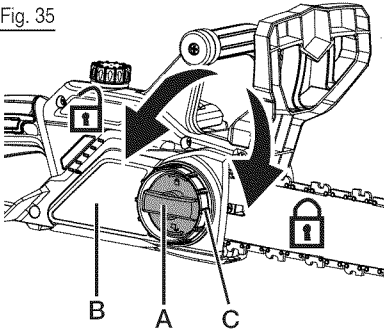
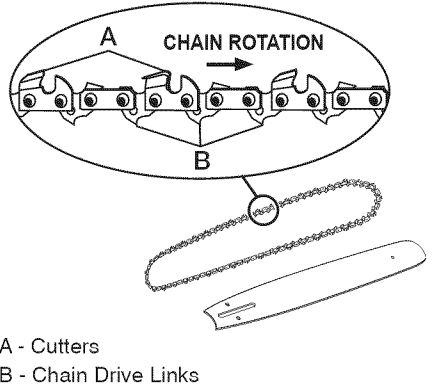

Fig. 35



- A - Lock Knob
- B - Chain Cover
- C - Chain Tensioning Knob

Fig. 36



- A - Cutters
- B - Chain Drive Links

Fig. 37

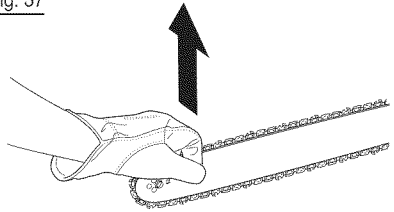
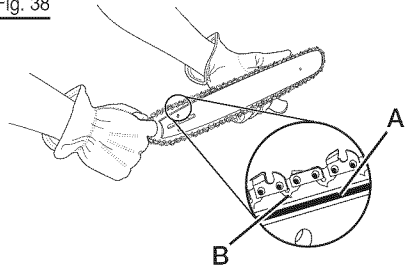

Fig. 38



- A - Bar Groove
- B - Chain Drive Links

Fig. 39

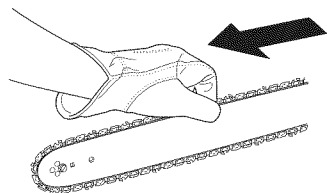
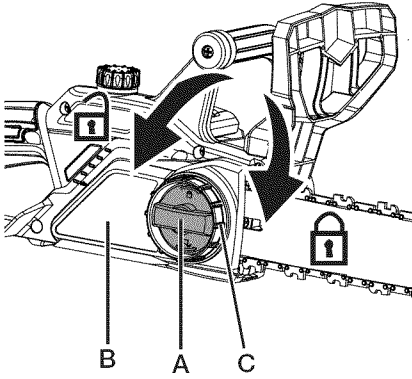
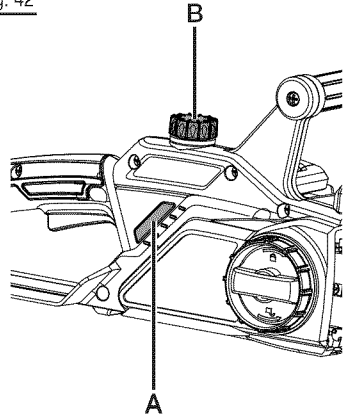

Fig. 40



- A - Lock Knob
- B - Chain Cover
- C - Chain Tensioning Knob

Fig. 42



- A - Quick View Oil Indicator
- B - Oil Reservoir Cap

Fig. 41

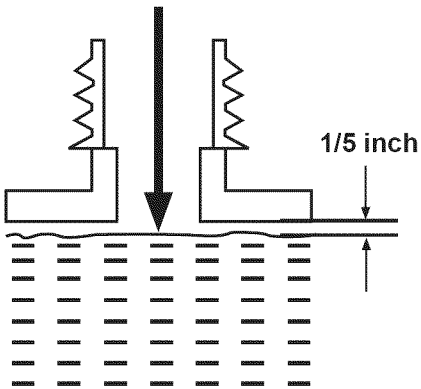

Fig. 43

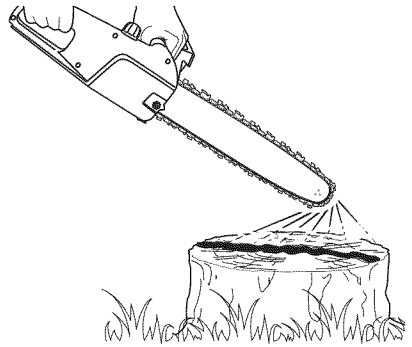

Fig. 44

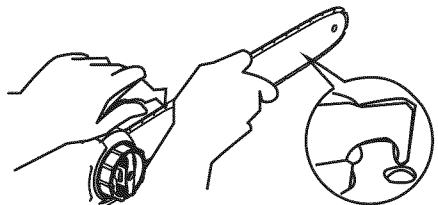

Fig. 45

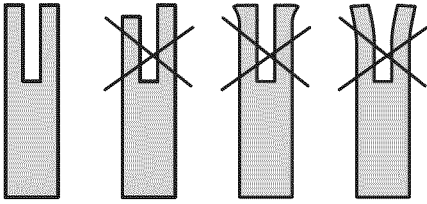
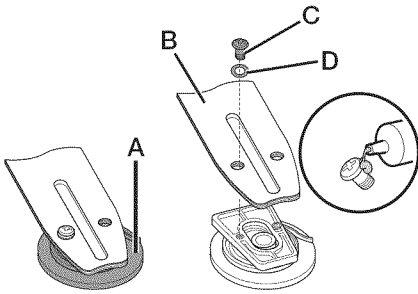
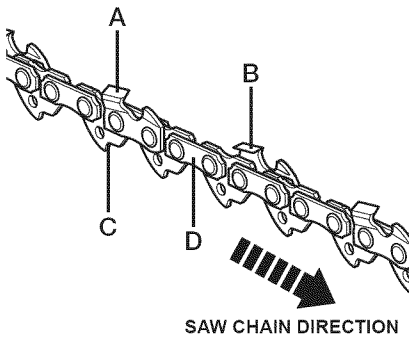

Fig. 45a



- A - Tension Disc
- B - Guide Bar
- C - Screw
- D - Rubber Washer

Fig. 47



- A - Right-hand Cutter
- B - Left-hand Cutter
- C - Bumper Drive Link
- D - Tie Strap

Fig. 46

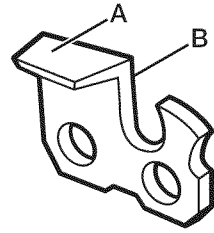

- A - Top Plate
- B - Side Plate

Fig. 48

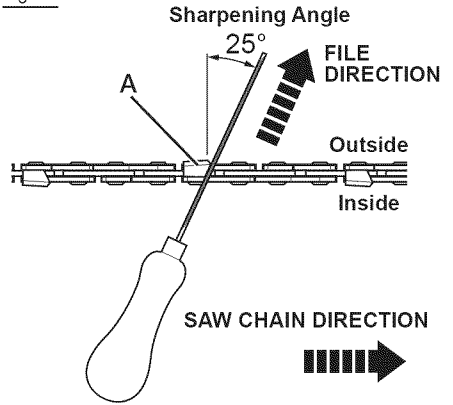

- A - Left-hand Cutter

Fig. 49

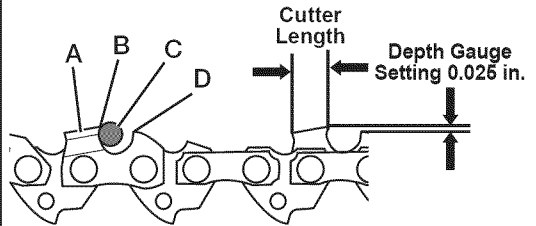

- A - Top Plate
- B - Cutting Tip
- C - File Position
- D - Ridge

CRAFTSMAN®

Product questions or problems?

1-888-331-4569

Customer Care Hot Line

**Get answers to questions, troubleshoot problems,
order parts, or schedule repair service.**

Para respuestas a preguntas o problemas, y ordenar
piezas o pedir servicio para la reparación de su equipo.

To help us help you, register your product at www.craftsman.com/registration

Para poderte ayudar mejor, registra tu producto en www.craftsman.com/registration

Join the Craftsman Club today!

CRAFTSMAN® CLUB

www.craftsman.com/signup

**Receive exclusive member benefits including special pricing and offers,
project sharing, expert advice, and SHOP YOUR WAY REWARDS!**

Como miembro exclusivo, recibe diversos beneficios como ofertas, precios especiales, proyectos nuevos, consejos de expertos y nuestro programa de puntos SHOP YOUR WAY REWARDS!

® Registered Trademark / ™ Trademark of KCD IP, LLC in the United States, or Sears Brands, LLC in other countries

® Marca Registrada / ™ Marca de Fábrica de KCD IP, LLC en Estados Unidos, o Sears Brands, LLC in otros países