

Owner's Manual

CRAFTSMAN®

**5.5 HORSEPOWER
21" REAR DISCHARGE
ROTARY LAWN MOWER**

Model No.
917.388270

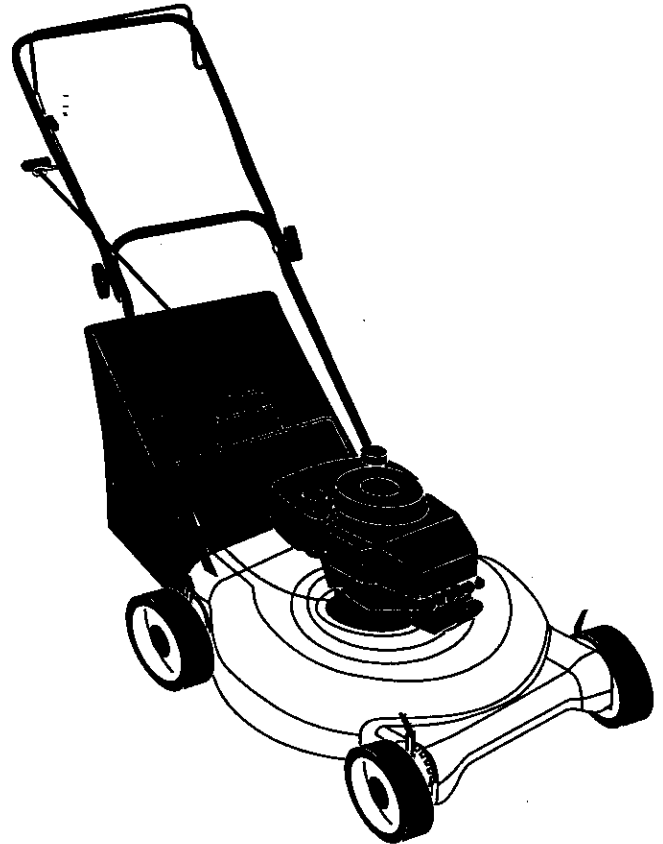

- **Safety**
- **Assembly**
- **Operation**
- **Maintenance**
- **Español**
- **Repair Parts**

CAUTION:

Read and follow all
Safety Rules and Instructions
before operating this equipment

Sears, Roebuck and Co., Hoffman Estates, IL 60179
Visit our Craftsman website: www.sears.com/craftsman

TABLE OF CONTENTS

| | | | |
|----------------------|---|-------------------------|------------|
| Warranty | 2 | Product Specifications | 10 |
| Safety Rules | 2 | Service and Adjustments | 12 |
| Assembly | 4 | Storage | 13 |
| Operation | 6 | Troubleshooting | 15 |
| Maintenance Schedule | 9 | Repair Parts | 32 |
| Maintenance | 9 | Parts Ordering | Back Cover |

WARRANTY

LIMITED TWO YEAR WARRANTY ON CRAFTSMAN POWER MOWER

For two years from date of purchase, when this Craftsman Lawn Mower is maintained, lubricated, and tuned up according to the operating and maintenance instructions in the owner's manual, Sears will repair free of charge any defect in material or workmanship. If this Craftsman Lawn Mower is used for commercial or rental purposes, this warranty applies for only 90 days from the date of purchase.

This Warranty does not cover:

- Expendable items which become worn during normal use, such as rotary mower blades, blade adapters, belts, air cleaners and spark plug.
- Repairs necessary because of operator abuse or negligence, including bent crankshafts and the failure to maintain the equipment according to the instructions contained in the owner's manual.

Warranty service is available by returning the Craftsman power mower to the nearest Sears Service Center/Department in the United States. This warranty applies only while this product is in use in the United States.

This Warranty gives you specific legal rights, and you may also have other rights which vary from state to state.

SEARS, ROEBUCK AND CO., D/817 WA, HOFFMAN ESTATES, ILLINOIS 60179

SAFETY RULES

Safety standards require operator presence control to minimize the risk of injury. Your unit is equipped with such controls. do not attempt to defeat the function of the operator presence controls under any circumstances.

TRAINING:

- Read this operator's manual carefully. Become familiar with the controls and know how to operate your mower properly. Learn how to quickly stop mower.
- Do not allow children to use your mower. Never allow adults to use mower without proper instructions.
- Keep the area of operation clear of all persons, especially small children and pets.
- Use mower only as the manufacturer intended and as described in this manual.

- Do not operate mower if it has been dropped or damaged in any manner. Always have damage repaired before using your mower.
- Do not use accessory attachments that are not recommended by the manufacturer. Use of such attachments may be hazardous.
- The blade turns when the engine is running.

PREPARATION:

- Always thoroughly check the area to be mowed and clear it of all stones, sticks, wires, bones, and other foreign objects. These objects will be thrown by the blade and can cause severe injury.
- Always wear safety glasses or eye shields when starting and while using your mower.
- Dress properly. Do not operate mower when barefoot or wearing open sandals.

Wear only solid shoes with good traction when mowing.

- Check fuel tank before starting engine. Do not fill gas tank indoors, when the engine is running or when the engine is hot. Allow the engine to cool for several minutes before filling the gas tank. Clean off any spilled gasoline before starting the engine.
- Always make wheel height adjustments before starting your mower. Never attempt to do this while the engine is running.
- Mow only in daylight or good artificial light.

OPERATION:

- Keep your eyes and mind on your mower and the area being cut. Do not let other interests distract you.
- Do not mow wet or slippery grass. Never run while operating your mower. Always be sure of your footing - keep a firm hold on the handles and walk.
- Do not put hands or feet near or under rotating parts. Keep clear of the discharge opening at all times.
- Always stop the engine whenever you leave or are not using your mower, or before crossing driveways, walks, roads, and any gravel-covered areas.
- Never direct discharge of material toward bystanders nor allow anyone near the mower while you are operating it.
- Before cleaning, inspecting, or repairing your mower, stop the engine and make absolutely sure the blade and all moving parts have stopped. Then disconnect the spark plug wire and keep it away from the spark plug to prevent accidental starting.
- Do not continue to run your mower if you hit a foreign object. Follow the procedure outlined above, then repair any damage before restarting and operating your mower.
- Do not change the governor settings or overspeed the engine. Engine damage or personal injury may result.
- Do not operate your mower if it vibrates abnormally. Excessive vibration is an indication of damage; stop the engine, safely check for the cause of vibration and repair as required.
- Do not run the engine indoors. Exhaust fumes are dangerous.

- Never cut grass by pulling the mower towards you. Mow across the face of slopes, never up and down or you might lose your footing. Do not mow excessively steep slopes. Use caution when operating the mower on uneven terrain or when changing directions - maintain good footing.
- Never operate your mower without proper guards, plates, grass catcher or other safety devices in place.

MAINTENANCE AND STORAGE:

- Check the blade and the engine mounting bolts often to be sure they are tightened properly.
- Check all bolts, nuts and screws at frequent intervals for proper tightness to be sure mower is in safe working condition.
- Keep all safety devices in place and working.
- To reduce fire hazard, keep the engine free of grass, leaves or excessive grease and oil.
- Check grass catcher often for deterioration and wear and replace worn bags. Use only replacement bags that are recommended by and comply with specifications of the manufacturer of your mower.
- Always keep a sharp blade on your mower.
- Allow engine to cool before storing in any enclosure.
- Never store mower with fuel in the tank inside a building where fumes may reach an open flame or an ignition source such as a hot water heater, space heater, clothes dryer, etc.

▲ Look for this symbol to point out important safety precautions. It means **CAUTION!!! BECOME ALERT!!! YOUR SAFETY IS INVOLVED.**

▲ CAUTION: Always disconnect spark plug wire and place wire where it cannot contact spark plug in order to prevent accidental starting when setting up, transporting, adjusting or making repairs.





▲ WARNING: The engine exhaust from this product contains chemicals known to the State of California to cause cancer, birth defects, or other reproductive harm.

ACCESSORIES





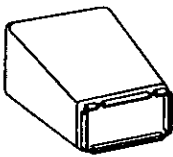

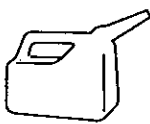
These accessories were available when this lawn mower was produced. They are also available at most Sears retail outlets and service centers. Most Sears stores can also

order repair parts for you, when you provide the model number of your lawn mower. Some of these accessories may not apply to your lawn mower.

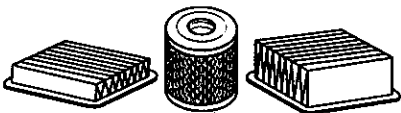
LAWN MOWER PERFORMANCE

| | | |
|---|--|--|
|  <p>CLIPPING DEFLECTOR FOR REAR DISCHARGE LAWN MOWERS</p> |  <p>MULCHER KITS</p> |  <p>STABILIZER</p> |
|  <p>GRASS CATCHERS FOR REAR DISCHARGE LAWN MOWERS</p> |  <p>GRASS CATCHERS FOR SIDE DISCHARGE LAWN MOWERS</p> |  <p>GAS CANS</p> |

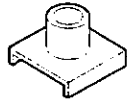
LAWN MOWER MAINTENANCE

| | | | | |
|--|---|--|---|---|
|  <p>MUFFLERS</p> | |  <p>AIR FILTERS</p> | |  <p>SPARK PLUGS</p> |
|  <p>BELTS</p> |  <p>BLADES</p> |  <p>BLADE ADAPTERS</p> |  <p>WHEELS</p> |  <p>ENGINE OIL</p> |

ASSEMBLY

Read these instructions and this manual in its entirety before you attempt to assemble or operate your new lawn mower. Your new lawn mower has been assembled at the factory with the exception of those parts left unassembled for shipping purposes. All parts such as nuts, washers, bolts, etc., necessary to complete the assembly have been placed in the parts bag. To ensure safe and proper operation of your lawn mower, all parts and hardware you assemble must be tightened securely. Use the correct tools as necessary to ensure proper tightness.

TO REMOVE LAWN MOWER FROM CARTON

- Remove loose parts included with mower.
- Cut down two end corners of carton and lay end panel down flat.
- Remove all packing materials except padding between upper and lower handle and padding holding operator presence control bar to upper handle.
- Roll lawn mower out of carton and check carton thoroughly for additional loose parts.

HOW TO SET UP YOUR LAWN MOWER

TO UNFOLD HANDLE

IMPORTANT: Unfold handles carefully so as not to pinch or damage control cables.

- Raise handles until lower handle section locks into place in mowing position.
- Remove protective padding, raise upper handle section into place on lower handles and tighten both handle knobs.
- Remove handle padding holding operator presence control bar to upper handle.
- Your lawn mower handle can be adjusted for your mowing comfort. Refer to "Adjust Handle" in the Service and Adjustment section of this manual.

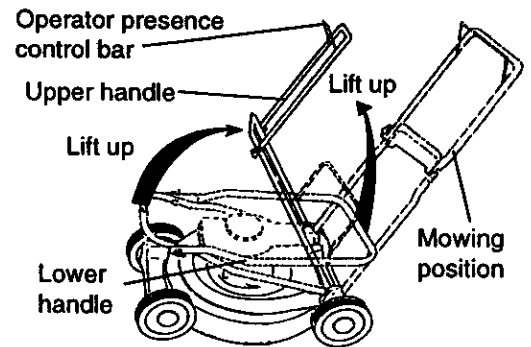

TO INSTALL ATTACHMENTS

Your lawn mower was shipped ready to be used as a mulcher.

OPERATION

KNOW YOUR LAWN MOWER

READ THIS OWNER'S MANUAL AND SAFETY RULES BEFORE OPERATING YOUR LAWN MOWER. Compare the illustrations with your lawn mower to familiarize yourself with the location of various controls and adjustments. Save this manual for future reference.

These symbols may appear on your lawn mower or in literature supplied with the product. Learn and understand their meaning.

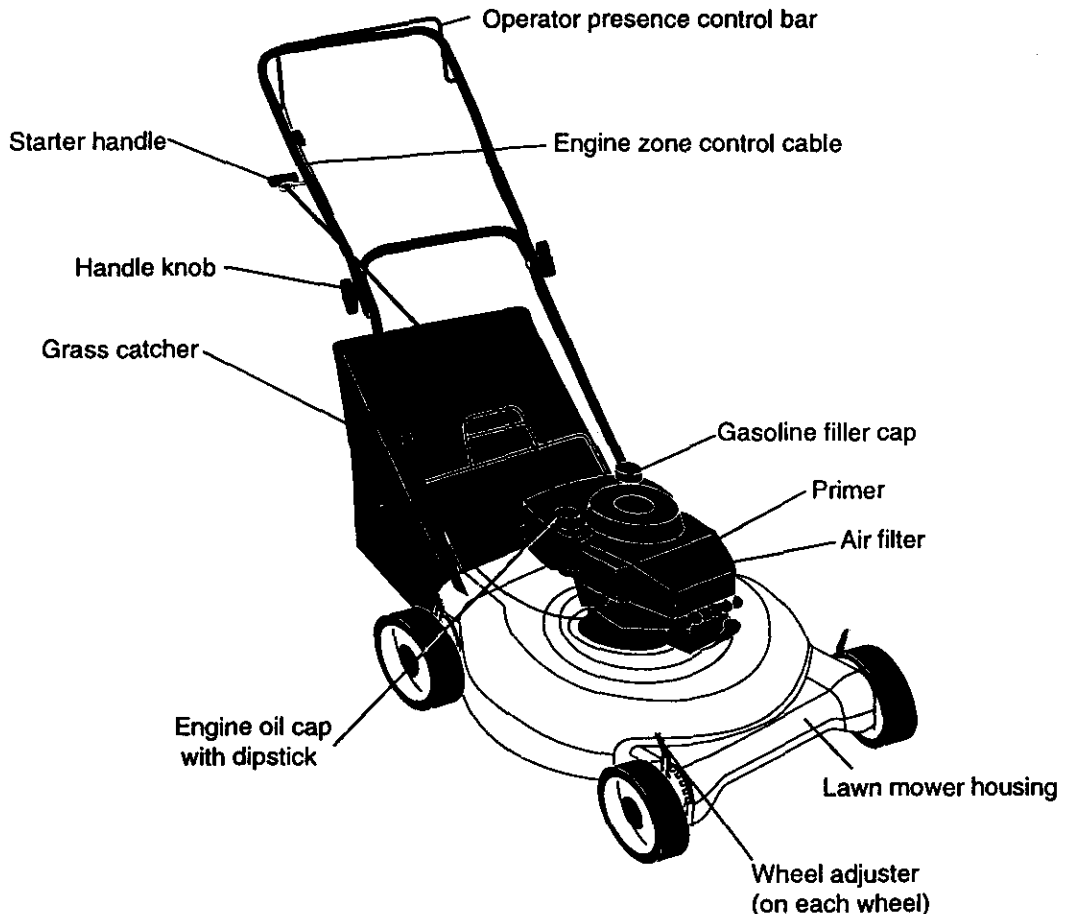
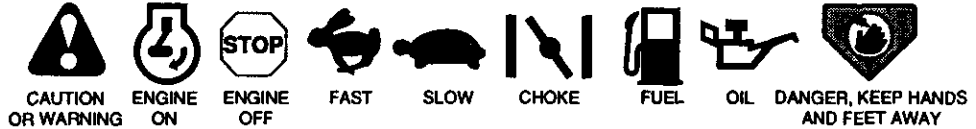

MEETS CPSC SAFETY REQUIREMENTS

Sears rotary walk-behind power lawn mowers conform to the safety standards of the American National Standards Institute and the U.S. Consumer Product Safety Commission. The blade turns when the engine is running.

Operator Presence Control Bar - must be held down to the handle to start the engine. Release to stop the engine.

Primer - pumps additional fuel from the carburetor to the cylinder for use when starting a cold engine.

Starter Handle - used for starting the engine.

The operation of any lawn mower can result in foreign objects thrown into the eyes, which can result in severe eye damage. Always wear safety glasses or eye shields while operating your lawn mower or performing any adjustments or repairs. We recommend a wide vision safety mask over spectacles or standard safety glasses.

HOW TO USE YOUR LAWN MOWER ENGINE SPEED CONTROL

The engine speed was set at the factory for optimum performance. Speed is not adjustable.

ENGINE ZONE CONTROL

▲CAUTION: Federal regulations require an engine control to be installed on this lawn mower in order to minimize the risk of blade contact injury. Do not under any circumstances attempt to defeat the function of the operator control. The blade turns when the engine is running.

- Your lawn mower is equipped with an operator presence control bar which requires the operator to be positioned behind the lawn mower handle to start and operate the lawn mower.

TO ADJUST CUTTING HEIGHT

- Raise wheels for low cut and lower wheels for high cut.
- Adjust cutting height to suit your requirements. Medium position is best for most lawns.
- To change cutting height, squeeze adjuster lever toward wheel. Move wheel up or down to suit your requirements. Be sure all wheels are in the same setting.

NOTE: Adjuster is properly positioned when plate tab inserts into hole in lever. Also, 9-position adjusters (if so equipped) allow lever to be positioned between the plate tabs.

Lower Wheels for High Cut

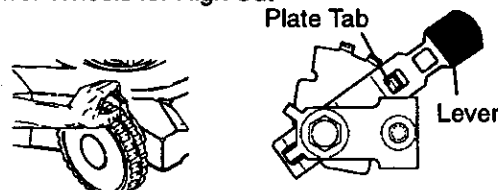

Raise Wheels for Low Cut

TO ATTACH GRASS CATCHER

- Lift the rear door of the lawn mower and place the grass catcher frame side hooks onto the door pivot pins.
- The grass catcher is secured to the lawn mower housing when the rear door is lowered onto the grass catcher frame.

CAUTION: Do not run your lawn mower without clipping deflector or approved grass catcher in place. Never attempt to operate the lawn mower with the rear door removed or propped open.

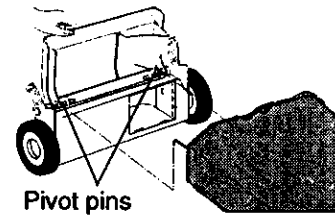

Pivot pins

TO EMPTY GRASS CATCHER

- Lift up on grass catcher using the frame handle.
- Remove grass catcher with clippings from under lawn mower handle.
- Empty clippings from bag using both frame handle and bag handle.

NOTE: Do not drag the bag when emptying; it will cause unnecessary wear.

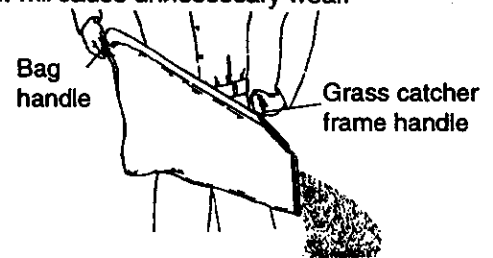

BEFORE STARTING ENGINE

OIL

Your lawn mower is shipped without oil in the engine.

- Be sure mower is level and area around oil fill is clean.
- Remove engine oil cap and fill to the full line on the dipstick.
- Use 20 ozs. of oil. For type and grade of oil to use, see "ENGINE" in the Maintenance section of this manual.
- Pour oil slowly. Do not over fill.
- Check oil level before each use. Add oil if needed. Fill to full line on dipstick.
- To read proper level, tighten engine oil cap each time.
- Reinstall engine oil cap and tighten.
- Change the oil after every 25 hours of operation or each season. You may need to change the oil more often under dusty, dirty conditions.

GAS

- Fill fuel tank. Use fresh, clean, regular unleaded gasoline with a minimum of 87 octane. Do not mix oil with gasoline. Purchase fuel in quantities that can be used within 30 days to assure fuel freshness.

WARNING: Experience indicates that alcohol blended fuels (called gasohol or using ethanol or methanol) can attract moisture which leads to separation and formation of acids during storage. Acidic gas can damage the fuel system of an engine while in storage. To avoid engine problems, the fuel system should be emptied before storage of 30 days or longer. Drain the fuel tank, start the engine and let it run until fuel lines and carburetor are empty. Use fresh fuel next season. See Storage Instructions for additional information. Never use engine or carburetor cleaner products in fuel tank or permanent damage may occur.

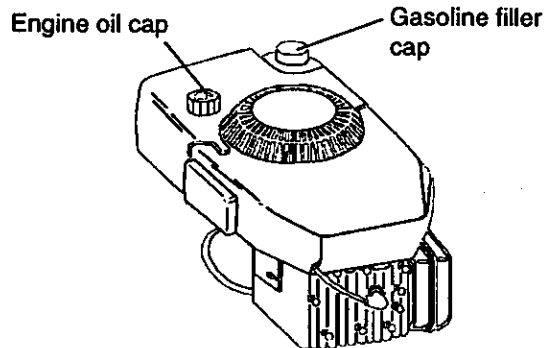

TO START ENGINE

- To start a cold engine, push primer five (5) times before trying to start. Use a firm push. This step is not usually necessary when starting an engine which has already run for a few minutes.
- Hold operator presence control bar down to the handle and pull starter handle quickly. Do not allow starter rope to snap back.
- To stop engine, release operator presence control bar.

NOTE: In cooler weather it may be necessary to repeat priming steps. In warmer weather over priming may cause flooding and engine will not start. If you do flood engine, wait a few minutes before attempting to start and do not repeat priming steps.

MOWING TIPS

- Under certain conditions, such as very tall grass, it may be necessary to raise the height of cut to reduce pushing effort and to keep from overloading the engine and leaving clumps of grass clippings. It may also be necessary to reduce ground speed and/or run the lawn mower over the area a second time.
- For extremely heavy cutting, reduce the width of cut by overlapping previously cut path and mow slowly.
- For better grass bagging and most cutting

conditions, the engine speed should be set in the fast position.

- Pores in cloth grass catchers can become filled with dirt and dust with use and catchers will collect less grass. To prevent this, regularly hose catcher off with water and let dry before using.
- Keep top of engine around starter clear and clean of grass clippings and chaff. This will help engine air flow and extend engine life.

MULCHING MOWING TIPS

IMPORTANT: For best performance, keep mower housing free of built-up grass and trash. Clean **UNDERSIDE OF MOWER HOUSING** after each use. See "Cleaning" in **MAINTENANCE** section of this manual.

- The special mulching blade will recut the grass clippings many times and reduce them in size so that as they fall onto the lawn they will disperse into the grass and not be noticed. Also, the mulched grass will biodegrade quickly to provide nutrients for the lawn. Always mulch with your highest engine (blade) speed as this will provide the best recutting action of the blades.
- Avoid cutting your lawn when it is wet. Wet grass tends to form clumps and interferes with the mulching action. The best time to mow your lawn is the early afternoon. At this time the grass has dried and the newly cut area will not be exposed to the direct sun.
- For best results, adjust the lawn mower cutting height so that the lawn mower cuts off only the top one-third of the grass blades. If the lawn is overgrown it will be necessary to raise the height of cut to reduce pushing effort and to keep from overloading the engine and leaving clumps of mulched grass. For extremely heavy mulching, reduce your width of cut, mow slowly and raise the rear of the lawn mower one wheel adjuster setting higher than the front.
- Certain types of grass and grass conditions may require that an area be mulched a second time to completely hide the clippings. When doing a second cut, mow across or perpendicular to the first cut path.
- Change your cutting pattern from week to week. Mow north to south one week then change to east to west the next week. This will help prevent matting and graining of the lawn.



MAINTENANCE

| MAINTENANCE SCHEDULE | | SERVICE DATES | | | | | | | | | | |
|---|---|-----------------|----------------|----------------|-----------------------------------|------------------|----------------|--|--|--|--|--|
| FILL IN DATES AS YOU COMPLETE REGULAR SERVICE | | BEFORE EACH USE | AFTER EACH USE | EVERY 10 HOURS | EVERY 25 HOURS OR EVERY SEASON | BEFORE STORAGE | | | | | | |
| M O W E R | Check for Loose Fasteners | ✓ | | | | ✓ | | | | | | |
| | Clean/Inspect Grass Catcher (If Equipped) | ✓ | ✓ | | | ✓ | | | | | | |
| | Clean Lawn Mower | | ✓ | | | ✓ | | | | | | |
| | Clean Under Drive Cover (Power-Propelled Mowers) | | | ✓ | | | | | | | | |
| | Check drive belt/pulleys (Power-Propelled Mowers) | | | | | ✓ | | | | | | |
| | Check/Sharpen/Replace Blade | | | | | ✓ ₃ | | | | | | |
| | Lubrication Chart | | | | | ✓ | ✓ | | | | | |
| E N G I N E | Clean Battery/Recharge (Electric Start Mowers) | | | | | ✓ | ✓ ₄ | | | | | |
| | Check Engine Oil Level | ✓ | | | | | | | | | | |
| | Change Engine Oil | | | | | ✓ _{1,2} | | | | | | |
| | Clean Air Filter | | | | | ✓ ₂ | | | | | | |
| | Inspect Muffler | | | | | ✓ | | | | | | |
| | Clean or Replace Spark Plug | | | | | ✓ | | | | | | |
| Replace Air Filter Paper Cartridge | | | | | ✓ ₂ | | | | | | | |

- 1 - Change more often when operating under a heavy load or in high ambient temperatures.
 2 - Service more often when operating in dirty or dusty conditions.
 3 - Replace blades more often when mowing in sandy soil.
 4 - Charge 48 hours at end of season.

GENERAL RECOMMENDATIONS

The warranty on this lawn mower does not cover items that have been subjected to operator abuse or negligence. To receive full value from the warranty, operator must maintain mower as instructed in this manual. Some adjustments will need to be made periodically to properly maintain your unit. All adjustments in the Service and Adjustments section of this manual should be checked at least once each season.

- Once a year, replace the spark plug, replace air filter element and check blade for wear. A new spark plug and clean/new air filter element assures proper air-fuel mixture and helps your engine run better and last longer.
- Follow the maintenance schedule in this manual.

BEFORE EACH USE

- Check engine oil level.
- Check for loose fasteners.

LUBRICATION

Keep unit well lubricated (See "LUBRICATION CHART").

LUBRICATION CHART

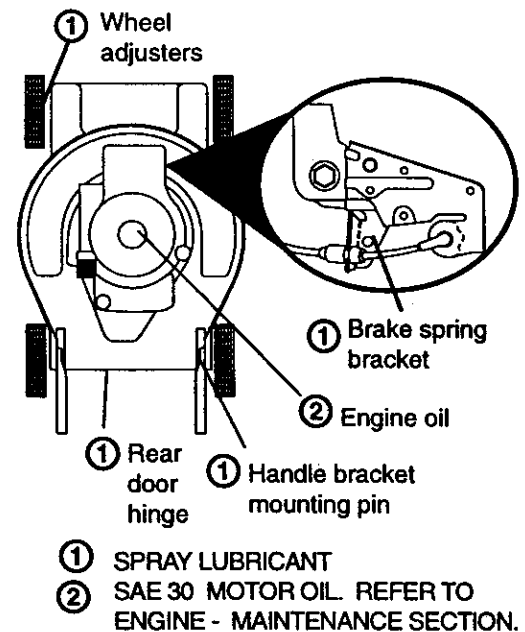

IMPORTANT: Do not oil or grease plastic wheel bearings. Viscous lubricants will attract dust and dirt that will shorten the life of the self lubricating bearings. If you feel they must be lubricated, use only a dry, powdered graphite type lubricant sparingly.

PRODUCT SPECIFICATIONS

| | |
|---|--------------------------|
| MODEL NUMBER | 917.388270 |
| SERIAL NUMBER | |
| DATE OF PURCHASE | |
| HORSEPOWER: | 5.5 |
| GASOLINE CAPACITY/ TYPE: | 1.5 QUARTS |
| OIL TYPE (API-SF/SG/SH): | UNLEADED REGULAR |
| | SAE 30 (ABOVE 32°F) |
| OIL CAPACITY: | SAE 5W-30 (BELOW 32°F) |
| | 20 OZS. |
| SPARK PLUG(GAP: .030") | CHAMPION RJ19LM OR J19LM |
| VALVE CLEARANCE: | INTAKE: .004 - .008 |
| | EXHAUST: .004 - .008 |
| SOLID STATE IGNITION | |
| AIR GAP: | .0125 IN. |
| BLADE BOLT TORQUE: | 35-40 FT. LBS. |
| <ul style="list-style-type: none"> The model and serial numbers will be found on a decal attached to the rear of the lawn mower housing. Record both serial number and date of purchase in space provided above. | |

LAWN MOWER

Always observe safety rules when performing any maintenance.

TIRES

- Keep tires free of gasoline, oil, or insect control chemicals which can harm rubber.
- Avoid stumps, stones, deep ruts, sharp objects and other hazards that may cause tire damage.

BLADE CARE

For best results, mower blade must be kept sharp. Replace bent or damaged blades.

TO REMOVE BLADE

- Disconnect spark plug wire from spark plug and place wire where it cannot come in contact with spark plug.
- Turn lawn mower on its side. Make sure air filter and carburetor are up.
- Use a wood block between blade and mower housing to prevent blade from turning when removing blade bolt.
- Protect your hands with gloves and/or wrap blade with heavy cloth.
- Remove blade bolt by turning counter-clockwise.

- Remove blade and attaching hardware (bolt, lock washer and hardened washer).

NOTE: Remove the blade adapter and check the key inside hub of blade adapter. The key must be in good condition to work properly. Replace adapter if damaged.

TO REPLACE BLADE

- Position the blade adapter on the engine crankshaft. Be sure key in adapter and crankshaft keyway are aligned.
- Position blade on the blade adapter aligning the two (2) holes in the blade with the raised lugs on the adapter.
- Be sure the trailing edge of blade (opposite sharp edge) is up toward the engine.
- Install the blade bolt with the lock washer and hardened washer into blade adapter and crankshaft.
- Use block of wood between blade and lawn mower housing and tighten the blade bolt, turning clockwise.
- The recommended tightening torque is 35-40 ft. lbs.

IMPORTANT: Blade bolt is grade 8 heat treated.

TO SHARPEN BLADE

NOTE: We do not recommend sharpening blade - but if you do, be sure the blade is balanced.

Care should be taken to keep the blade balanced. An unbalanced blade will cause eventual damage to lawn mower or engine.

- The blade can be sharpened with a file or on a grinding wheel. Do not attempt to sharpen while on the mower.
- To check blade balance, drive a nail into a beam or wall. Leave about one inch of the straight nail exposed. Place center hole of blade over the head of the nail. If blade is balanced, it should remain in a horizontal position. If either end of the blade moves downward, sharpen the heavy end until the blade is balanced.

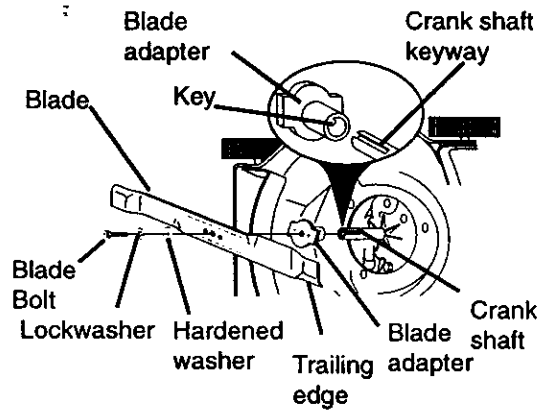

GRASS CATCHER

- The grass catcher may be hosed with water, but must be dry when used.
- Check your grass catcher often for damage or deterioration. Through normal use it will wear. If catcher needs replacing, replace only with a manufacturer approved replacement catcher. Give the lawn mower model number when ordering.

ENGINE

LUBRICATION

Use only high quality detergent oil rated with API service classification SF, SH or SG. Select the oil's SAE viscosity grade according to your expected operating temperature.

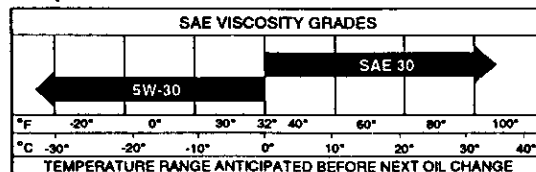

NOTE: Although multi—viscosity oils (5W30, 10W30 etc.) improve starting in cold weather, these multi—viscosity oils will result in increased oil consumption when used above 32°F. Check your engine oil level more frequently to avoid possible engine damage from running low on oil. Change the oil after every 25 hours of operation or at least once a year if the lawn mower is not used for 25 hours in one year.

Check the crankcase oil level before starting the engine and after each five (5) hours of continuous use. Tighten oil plug securely each time you check the oil level.

TO CHANGE ENGINE OIL

NOTE: Before tipping lawn mower to drain oil, drain fuel tank by running engine until fuel tank is empty.

- Disconnect spark plug wire from spark plug and place wire where it cannot come in contact with spark plug.
- Remove engine oil cap; lay aside on a clean surface.
- Tip lawn mower on its side and drain oil into a suitable container. Rock lawn mower back and forth to remove any oil trapped inside of engine.
- Wipe off any spilled oil on lawn mower and on side of engine.
- Fill engine with oil. Fill only to the "FULL" line on the dipstick. DO NOT OVER FILL.
- Replace engine oil cap.
- Reconnect spark plug wire to spark plug.

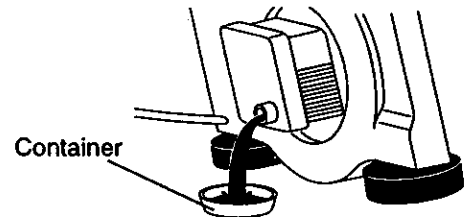

AIR FILTER

Your engine will not run properly and may be damaged by using a dirty air filter. Replace the air filter every year, more often if you mow in very dusty, dirty conditions. Do not wash air filter.

TO CHANGE AIR FILTER

- Remove the air filter cover by turning counterclockwise to the stop and pull away from collar.
- Remove filter from inside of cover.

- Clean the inside of the cover and the collar to remove any dirt accumulation.
- Insert new filter into cover.
- Put air filter cover and filter into collar aligning the tab with the slot.
- Push in on cover and turn clockwise to tighten.

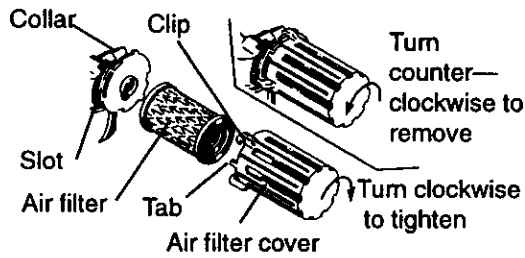

MUFFLER

Inspect and replace corroded muffler as it could create a fire hazard and/or damage.

SPARK PLUG

Change your spark plug each year to make your engine start easier and run better. Set spark plug gap at .030 inch.

CLEANING

IMPORTANT: For best performance, keep mower housing free of built-up grass and trash. Clean underside of mower housing after each use.

CAUTION: Disconnect spark plug wire from spark plug and place wire where it cannot come in contact with the spark plug.

- Turn lawn mower on its side. Make sure air filter and carburetor are up. Clean the underside of your lawn mower by scraping to remove build-up of grass and trash.
- Clean engine often to keep trash from accumulating. A clogged engine runs hotter and shortens engine life.
- Keep finished surfaces and wheels free of all gasoline, oil, etc.
- We DO NOT recommend using a garden hose to clean lawn mower unless the electrical system, muffler, air filter and carburetor are covered to keep water out. Water in engine can result in shortened engine life.

SERVICE AND ADJUSTMENTS

CAUTION: Before performing any service or adjustments:

- Release control bar and stop engine.
- Make sure the blade and all moving parts have completely stopped.
- Disconnect spark plug wire from spark plug and place where it cannot come in contact with plug.

LAWN MOWER

TO ADJUST CUTTING HEIGHT

See "TO ADJUST CUTTING HEIGHT" in the Operation section of this manual.

REAR DEFLECTOR

The rear deflector, attached between the rear wheels of your lawn mower, is provided to minimize the possibility that objects will be thrown out the rear of the lawn mower into the operator's mowing position.

If the rear deflector becomes damaged, it should be replaced.

TO ADJUST HANDLE

The handle can be mounted in a high or low position. The mounting holes in the bottom of lower handle are off center for raising or lowering the handle.

- Remove upper handle and all parts attached to lower handle.
- Remove hairpin cotters from lower handle bracket mounting pin.
- Squeeze lower handle in to remove it from mounting pins.
- Turn lower handle over to raise or lower handle.
- Squeeze lower handle in and position holes onto mounting pins on handle bracket.
- Reassemble upper handle and all parts removed from lower handle.

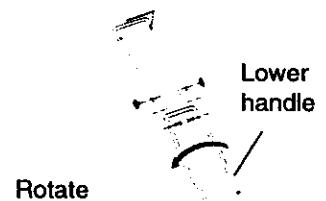

ENGINE CARBURETOR

Your carburetor has a non-adjustable fixed main jet for mixture control. If your engine does not operate properly due to suspected carburetor problems, take your lawn mower to an authorized service center for repair or adjustment.

IMPORTANT: Never tamper with the engine governor, which is factory set for proper engine speed. Overspeeding the engine above the factory high speed setting can be dangerous.

if you think the engine-governed high speed needs adjusting, contact your nearest **AUTHORIZED** service center, which has proper equipment and experience to make any necessary adjustments.

ENGINE SPEED

Your engine speed has been factory set. Do not attempt to increase engine speed or it may result in personal injury. If you believe that the engine is running too fast or too slow, take your lawn mower to an authorized service center for repair and adjustment.

STORAGE

Immediately prepare your lawn mower for storage at the end of the season or if the unit will not be used for 30 days or more.

LAWN MOWER

When lawn mower is to be stored for a period of time, clean it thoroughly, remove all dirt, grease, leaves, etc. Store in a clean, dry area.

- Clean entire lawn mower (See "CLEANING" in the Maintenance section of this manual).
- Lubricate as shown in the Maintenance section of this manual.
- Be sure that all nuts, bolts, screws, and pins are securely fastened. Inspect moving parts for damage, breakage and wear. Replace if necessary.
- Touch up all rusted or chipped paint surfaces; sand lightly before painting.

HANDLE

You can fold your lawn mower handle for storage.

- Squeeze the bottom ends of the lower handle toward each other until the lower handle clears the handle bracket, then move handle forward.
- Loosen upper handle mounting bolts enough to allow upper handle to be folded back.

IMPORTANT: When folding the handle for storage or transportation, be sure to fold handle as shown or you may damage the control cables.

- When setting up your handle from the storage position, the lower handle will automatically lock into the mowing position.

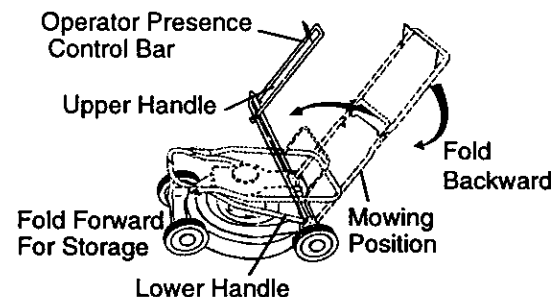
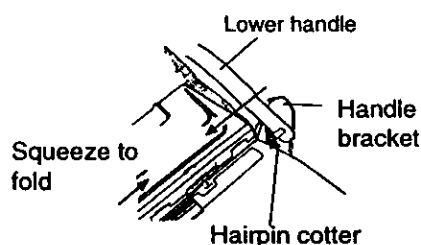

ENGINE FUEL SYSTEM

IMPORTANT: It is important to prevent gum deposits from forming in essential fuel system parts such as carburetor, fuel filter, fuel hose, or tank during storage.

Also, experience indicates that alcohol blended fuels (called gasohol or using ethanol or methanol) can attract moisture which leads to separation and formation of acids during storage. Acidic gas can damage the fuel system of an engine while in storage.

- Drain the fuel tank.
- Start the engine and let it run until the fuel lines and carburetor are empty.
- Never use engine or carburetor cleaner products in the fuel tank or permanent damage may occur.
- Use fresh fuel next season.

NOTE: Fuel stabilizer is an acceptable alternative in minimizing the formation of fuel gum deposits during storage. Add stabilizer to gasoline in fuel tank or storage container. Always follow the mix ratio found on stabilizer container. Run engine at least 10 minutes after adding stabilizer to allow the stabilizer to reach the carburetor. Do not drain the gas tank and carburetor if using fuel stabilizer.

ENGINE OIL

Drain oil (with engine warm) and replace with clean engine oil. (See "ENGINE" in the Maintenance section of this manual).

CYLINDER

- Remove spark plug.
- Pour one ounce (29 ml) of oil through spark plug hole into cylinder.
- Pull starter handle slowly a few times to distribute oil.
- Replace with new spark plug.

OTHER

- Do not store gasoline from one season to another.
- Replace your gasoline can if your can starts

to rust. Rust and/or dirt in your gasoline will cause problems.

- If possible, store your unit indoors and cover it to give protection from dust and dirt.
- Cover your unit with a suitable protective cover that does not retain moisture. Do not use plastic. Plastic cannot breathe which allows condensation to form and will cause your unit to rust.

IMPORTANT: Never cover mower while engine and exhaust areas are still warm.

▲CAUTION: Never store the lawn mower with gasoline in the tank inside a building where fumes may reach an open flame or spark. Allow the engine to cool before storing in any enclosure.

TROUBLESHOOTING CHART

| PROBLEM | CAUSE | CORRECTION |
|---|--|---|
| Does not start | <ul style="list-style-type: none"> • Dirty air filter. • Out of fuel. • Stale fuel. • Water in fuel. • Spark plug wire is disconnected. • Bad spark plug. • Loose blade or broken blade adapter. • Control bar in released position. • Control bar defective. | <ul style="list-style-type: none"> • Clean/replace air filter. • Fill fuel tank. • Drain tank and refill with fresh clean fuel. • Drain fuel tank and carburetor and refill tank with fresh gasoline. • Connect wire to plug. • Replace spark plug. • Tighten blade bolt or replace blade adapter. • Depress control bar to handle. • Replace control bar. |
| Loss of power | <ul style="list-style-type: none"> • Rear of lawn mower housing or cutting blade dragging in heavy grass. • Cutting too much grass. • Dirty air filter. • Buildup of grass, leaves, and trash under mower. • Too much oil in engine. • Walking speed too fast. | <ul style="list-style-type: none"> • Set to "Higher Cut" position. • Set to "Higher Cut" position. • Clean/replace air filter. • Clean underside of mower housing. • Check oil level. • Cut at slower walking speed. |
| Poor cut – uneven | <ul style="list-style-type: none"> • Worn, bent or loose blade. • Wheel heights uneven. • Buildup of grass, leaves and trash under mower. | <ul style="list-style-type: none"> • Replace blade. Tighten blade bolt. • Set all wheels at same height • Clean underside of mower housing. |
| Excessive vibration | <ul style="list-style-type: none"> • Worn, bent or loose blade. • Bent engine crankshaft. | <ul style="list-style-type: none"> • Replace blade. Tighten blade bolt. • Contact an authorized service center. |
| Starter rope hard to pull | <ul style="list-style-type: none"> • Engine flywheel brake is on when control bar is released. • Bent engine crankshaft. • Blade adapter broken. • Blade dragging in grass. | <ul style="list-style-type: none"> • Depress control bar to upper handle before pulling starter rope. • Contact an authorized service center. • Replace blade adapter. • Move lawn mower to cut grass or to hard surface to start engine. |
| Grass catcher not filling (if so equipped) | <ul style="list-style-type: none"> • Cutting height too low. • Lift on blade worn off. • Catcher not venting air. | <ul style="list-style-type: none"> • Raise cutting height. • Replace blade. • Clean grass catcher. |
| Hard to push | <ul style="list-style-type: none"> • Grass is too high or wheel height is too low. • Rear of lawn mower housing or blade dragging in grass. • Grass catcher too full. • Handle height position not right for you. | <ul style="list-style-type: none"> • Raise cutting height. • Raise rear of lawn mower housing one (1) setting higher. • Empty grass catcher. • Adjust handle height to suit. |

For in-home major brand repair service:

Call 24 hours a day, 7 days a week

1-800-4-MY-HomeSM (1-800-469-4663)

Para pedir servicio de reparación a domicilio

1-800-676-5811

In Canada for all your service and parts needs call

Au Canada pour tout le service ou les pièces

1-800-665-4455

For the repair or replacement parts you need:

Call 6 am-11pm CST, 7 days a week

PartsDirectSM

1-800-366-PART (1-800-366-7278)

Para ordenar piezas con entrega a domicilio

1-800-659-7084

**For the location of a Sears Parts and Repair Center
in your area:**

Call 24 Hours a day, 7 days a week

1-800-488-1222

**For information on purchasing a Sears Maintenance Agree-
ment or to inquire about an existing Agreement:**

Call 9 am-5 pm, Monday - Saturday

1-800-827-6655

