

# Operator's Manual

# CRAFTSMAN®

## 2.4 cu.in./40cc 2-Cycle GASOLINE CHAIN SAW

Model No.

**358.351810 – 18 in. Bar**

- Safety
- Assembly
- Operation
- Maintenance
- Parts List
- Español, p. 27

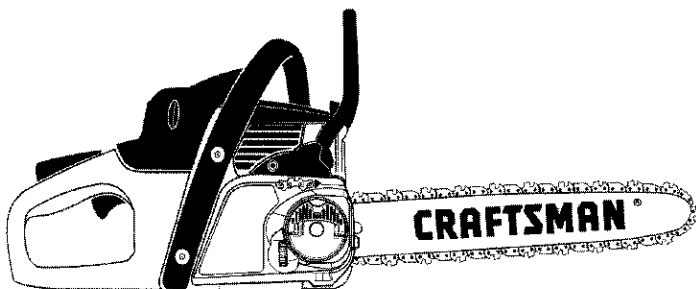

### **WARNING:**

Read and follow all Safety Rules and Operating Instructions before first use of this product.



For answers to your questions about this product:  
Call 7 am–7 pm, Mon–Sat; Sun, 10 am–7 pm

■ **1-800-235-5878** (Hours listed are Central Time)

Sears, Roebuck and Co., Hoffman Estates, IL 60179 U.S.A.

545186815 Rev. 1 6/15/08 BRW

## TABLE OF CONTENTS

Warranty	2	Storage	20
Safety Rules	2	Troubleshooting Table	21
Assembly	6	Emissions Statement	23
Operation	7	Parts List	25
Maintenance	14	Spanish	27
Service and Adjustments	17	Parts & Ordering	Back Cover

## WARRANTY STATEMENT

### ONE YEAR FULL WARRANTY ON CRAFTSMAN GAS CHAIN SAW

When used and maintained according to the operator's manual, if this product fails due to a defect in material or workmanship within one year from the date of purchase, return it to any Sears store, Sears Service Center, or other Craftsman outlet in the United States for free repair (or replacement if repair proves impossible).

This warranty excludes the bar, chain, spark plug and air filter, which are expendable parts that can wear out from normal use in less than one year.

This warranty applies for only 30 days from purchase date if this product is used for commercial or rental purposes.

This warranty gives you specific legal rights, and you may also have other rights which vary from state to state.

Sears, Roebuck and Co., Hoffman Estates, IL 60179

## SAFETY RULES

**⚠ WARNING:** Always disconnect spark plug wire when making repairs except for carburetor adjustments. Because a chain saw is a high-speed wood-cutting tool, special precautions must be observed to reduce the risk of accidents. Careless or improper use of this tool can cause serious injury.

### PLAN AHEAD

- Restrict the use of your saw to adult users who understand and can follow safety rules, precautions, and operating instructions found in this manual.

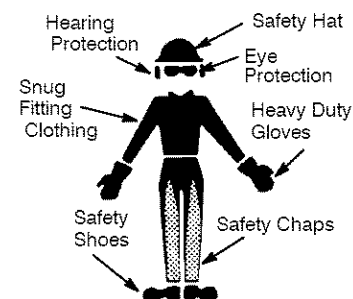

- Wear protective gear. Always use steel-toed safety footwear with non-slip

soles; snug-fitting clothing; heavy-duty, non-slip gloves; eye protection such as non-fogging, vented goggles or face screen; an approved safety hard hat; and sound barriers (ear plugs or mufflers) to protect your hearing. Regular users should have hearing checked regularly as chain saw noise can damage hearing.

- Secure hair above shoulder length. Do not wear loose clothing or jewelry; they can get caught in moving parts.
- Keep all parts of your body away from the chain when the engine is running.
- Keep children, bystanders, and animals a minimum of 30 feet (10 meters) away from the work area when starting and using the saw.
- Do not handle or operate a chain saw when you are fatigued, ill, or upset, or if you have taken alcohol, drugs, or medication. You must be in good physical condition and mentally alert. If you have any condition that might be aggravated by strenuous work, check with doctor before operating.
- Do not start cutting until you have a clear work area, secure footing, and, if you are felling trees, a planned retreat path.

## OPERATE YOUR SAW SAFELY

- Do not operate a chain saw with one hand. Serious injury to the operator, helpers, bystanders or any combination of these persons may result from one-handed operation. A chain saw is intended for two-handed use.
- Operate the chain saw only in a well-ventilated outdoor area.
- Do not operate saw from a ladder or in a tree.
- Make sure the chain will not make contact with any object while starting the engine. Never try to start the saw when the guide bar is in a cut.
- Do not put pressure on the saw at the end of the cut. Applying pressure can cause you to lose control when the cut is completed.
- Stop engine before setting saw down.
- Hand carry saw only when engine is stopped. Carry with muffler away from body; guide bar & chain projecting behind you; guide bar preferably covered with a scabbard.
- Do not operate a chain saw that is damaged, improperly adjusted, or not completely and securely assembled. Always replace bar, chain, hand guard, or chain brake immediately if it becomes damaged, broken or is otherwise removed.

## MAINTAIN YOUR SAW IN GOOD WORKING ORDER

- ⚠ WARNING:** Disconnect the spark plug before performing maintenance except carburetor adjustments.
- Have all chain saw service performed by a qualified service dealer with the exception of the items listed in the MAINTENANCE section of this manual.
  - Make certain the saw chain stops moving when the throttle trigger is released. For correction, refer to CARBURETOR ADJUSTMENT.
  - Keep the handles dry, clean, and free from oil or fuel mixture.
  - Keep caps and fasteners securely tightened.
  - Nonconforming replacement components or the removal of safety devices may cause damage to the unit and possible injury to the operator or bystanders. Use only Craftsman accessories and replacement parts as recommended. Never modify your saw.
  - Maintain chain saw with care.
  - Keep unit sharp and clean for better and safer performance.

- Follow instructions for lubricating and changing accessories.
- Check for damaged parts. Before further use of the chain saw, a guard or other part that is damaged should be carefully checked to determine that it will operate properly and perform its intended function. Check for alignment of moving parts, binding of moving parts, breakage of parts, mounting and any other conditions that may affect its operation. A guard or other part that is damaged should be properly repaired or replaced by a Sears Service Center unless otherwise indicated elsewhere in the operator's manual.
- When not in use, chain saws should be stored in a dry, high or locked-up place out of the reach of children.
- When storing saw, use a scabbard or carrying case.

## HANDLE FUEL WITH CAUTION

- Do not smoke while handling fuel or while operating the saw.
- Eliminate all sources of sparks or flame in the areas where fuel is mixed or poured.
- Mix and pour fuel in an outdoor area and use an approved, marked container for all fuel purposes. Wipe up all fuel spills before starting saw.
- Move at least 10 feet (3 meters) from fueling site before starting engine.
- Turn the engine off and let saw cool in a non-combustible area, not on dry leaves, straw, paper, etc. Slowly remove fuel cap and refuel unit.
- Empty the fuel tank before storing or transporting the unit. Use up fuel left in the carburetor by starting the engine and letting it run until it stops.
- Store the unit and fuel in an area where fuel vapors cannot reach sparks or open flames from water heaters, electric motors or switches, furnaces, etc.

## GUARD AGAINST KICKBACK

Follow all safety rules to help avoid kickback and other forces which can result in serious injury.

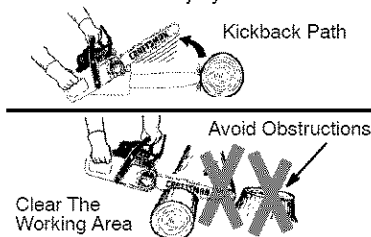

**⚠ WARNING:** Avoid kickback which can result in serious injury. **Kickback** is the backward, upward or sudden forward motion of the guide bar occurring when the saw chain near the upper tip of the guide bar contacts any object such as a log or branch, or when the wood closes in and pinches the saw chain in the cut. Contacting a foreign object in the wood can also result in loss of chain saw control.

- **Rotational Kickback** can occur when the moving chain contacts an object at the upper tip of the guide bar. This contact can cause the chain to dig into the object, which stops the chain for an instant. The result is a lightning fast, reverse reaction which kicks the guide bar up and back toward the operator.
- **Pinch-Kickback** can occur when the wood closes in and pinches the moving saw chain in the cut along the top of the guide bar and the saw chain is suddenly stopped. This sudden stopping of the chain results in a reversal of the chain force used to cut wood and causes the saw to move in the opposite direction of the chain rotation. The saw is driven straight back toward the operator.
- **Pull-In** can occur when the moving chain contacts a foreign object in the wood in the cut along the bottom of the guide bar and the saw chain is suddenly stopped. This sudden stopping pulls the saw forward and away from the operator and could easily cause the operator to lose control of the saw.

### REDUCE THE CHANCE OF KICKBACK

- Recognize that kickback can happen. With a basic understanding of kickback, you can reduce the element of surprise which contributes to accidents.
- Never let the moving chain contact any object at the tip of the guide bar.
- Keep the working area free from obstructions such as other trees, branches, rocks, fences, stumps, etc. Eliminate or avoid any obstruction that your saw chain could hit while you are cutting.
- When cutting a branch, do not let the guide bar contact branch or other objects around it.

- Keep saw chain sharp and properly tensioned. A loose or dull chain can increase the chance of kickback. Follow manufacturer's chain sharpening and maintenance instructions. Check tension at regular intervals, but never with the engine running. Make sure the bar nuts are securely tightened.
- Begin and continue cutting at full speed. If the chain is moving at a slower speed, there is greater chance of kickback occurring.
- Use extreme caution when re-entering a previous cut.
- Do not attempt cuts starting with the tip of the bar (plunge cuts).
- Watch for shifting logs or other forces that could close a cut and pinch or fall into chain.
- Use the Reduced-Kickback Guide Bar and Low-Kickback Chain specified for your saw.

### Avoid Pinch-Kickback:

- Be extremely aware of situations or obstructions that can cause material to pinch the top of or otherwise stop the chain.
- Do not cut more than one log at a time.
- Do not twist the saw as the bar is withdrawn from an undercut when bucking.

### Avoid Pull-In:

- Always begin cutting with the engine at full speed and the saw housing against wood.
- Use wedges made of plastic or wood. Never use metal to hold the cut open.

### MAINTAIN CONTROL

Stand to the left of the saw  
Thumb on underside of handlebar

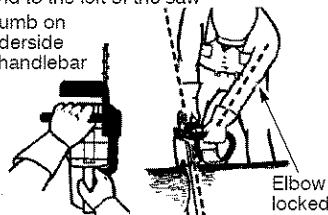

Never reverse hand positions

- A good, firm grip on the saw with both hands will help you maintain control. Don't let go. Grip the rear handle with your right hand whether you are right or left handed. Wrap the fingers of your left hand over and around the front handlebar, and your left thumb under the front handlebar. Keep your left arm straight with the elbow locked.

- Position your left hand on the front handlebar so it is in a straight line with your right hand on the rear handle when making bucking cuts. Never reverse right and left hand positions for any type of cutting.
- Stand with your weight evenly balanced on both feet.
- Do not overreach. You could be drawn or thrown off balance and lose control of the saw.
- Do not cut above shoulder height. It is difficult to maintain control of saw above shoulder height.

### KICKBACK SAFETY FEATURES

**⚠ WARNING:** The following features are included on your saw to help reduce the hazard of kickback; however, such features will not totally eliminate this danger. Do not rely only on safety devices. Follow all safety rules to help avoid kickback and other forces which can result in serious injury.

- Front Hand Guard, designed to reduce the chance of your left hand contacting the chain if your hand slips off the front handlebar.
- Position of front and rear handlebars, designed with distance between handles and "in-line" with each other. The spread and "in-line" position of the hands provided by this design work together to give balance and resistance in controlling the pivot of the saw back toward the operator if kickback occurs.
- Reduced-Kickback Guide Bar, designed with a small radius tip which reduces the size of the kickback danger zone on the bar tip. This type of bar has been demonstrated to significantly reduce the number and seriousness of kickbacks when tested in accordance with ANSI B175.1.

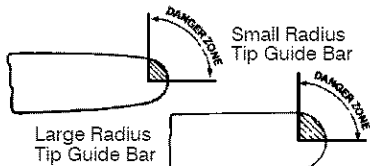

- Low-Kickback Chain, has met kickback performance requirements when tested on a representative sample of chain saws below 3.8 cubic inch displacement specified in ANSI B175.1.

### Low-Kickback Chain

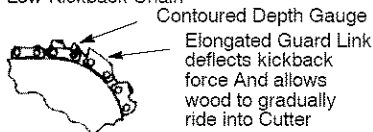

### CHAIN BRAKE

- Chain Brake, designed to stop the chain in the event of kickback.

**⚠ WARNING:** WE DO NOT REPRESENT AND YOU SHOULD NOT ASSUME THAT THE CHAIN BRAKE WILL PROTECT YOU IN THE EVENT OF A KICKBACK. Kickback is a lightning fast action which throws the bar and rotating chain back and up toward the operator. Kickback can be caused by allowing contact of the bar tip in the danger zone with any hard object. Kickback can also be caused by pinching the saw chain along the top of the guide bar. This action may push the guide bar rapidly back toward the operator. Either of these events may cause you to lose control of the saw which could result in serious injury or even death. DO NOT RELY UPON ANY OF THE DEVICES BUILT INTO YOUR SAW. YOU SHOULD USE THE SAW PROPERLY AND CAREFULLY TO AVOID KICKBACK. Reduced-kickback guide bars and low-kickback saw chains reduce the chance and magnitude of kickback and are recommended. Your saw has a low kickback chain and bar as original equipment. Repairs on a chain brake should be made by an authorized Sears Service Center. Take your unit to the place of purchase if purchased from a servicing dealer, or to your nearest Sears Service Center

- Tip contact in some cases may cause a lightning fast reverse REACTION, kicking guide bar up and back toward operator.
- Pinching the saw chain along the top of the guide bar may push the guide bar rapidly back toward the operator.
- Either of these reactions may cause you to lose control of the saw which could result in serious injury. Do not rely exclusively upon devices built into your saw.

This unit is not equipped with an anti-vibration system and is intended for occasional use only.

**SAFETY NOTICE:** Exposure to vibrations through prolonged use of gasoline powered hand tools could cause blood vessel or nerve damage in the fingers, hands, and joints of people prone to circulation disorders or abnormal swellings. Prolonged use in cold weather has been linked to blood vessel damage in otherwise healthy people. If symptoms occur such as numbness, pain, loss of strength, change in skin color or texture, or loss of feeling in the fingers, hands, or joints, discontinue the use of this tool and seek medical attention. An anti-vibration system does not guarantee the avoidance of these problems. Users who operate power tools on a continual and regular basis must monitor closely their physical condition and the condition of this tool.

**CHAIN BRAKE:** If this saw is to be used for commercial logging, a chain brake is required and shall not be removed or otherwise disabled to comply with Federal OSHA Regulations for Commercial Logging.

**SPARK ARRESTING SCREEN:** Your saw is equipped with a temperature limiting muffler and spark arresting screen which meets the requirements of California Codes 4442 and 4443. All U.S. forest land and the states of California, Idaho, Maine, Minnesota, New Jersey, Oregon, and Washington require by law that many internal combustion engines to be equipped with a spark arresting screen. If you operate a chain saw in a state or locale where such regulations exist, you are legally responsible for maintaining the operating condition of these parts. Failure to do so is a violation of the law. Refer to the Customer Responsibilities chart in the MAINTENANCE section.

**STANDARDS:** This chain saw is listed by Underwriters Laboratories, Inc. in accordance with American National Standards for Gasoline-Powered Chain Saws Safety Requirements (ANSI B175.1-2000).

## ASSEMBLY

**⚠ WARNING:** Before using chain saw, ensure all fasteners are secure.

### CARTON CONTENTS

Check carton contents against the following list.

#### Model 358.351810

- Chain saw (fully assembled)
- 2-cycle engine oil

Examine parts for damage. Do not use damaged parts.

If you need assistance or find that parts are missing or damaged, please call 1-800-235-5878.

**NOTE:** It is normal to hear the fuel filter rattle in an empty fuel tank.

Your unit has been factory tested and the carburetor precisely adjusted. As a result you may smell gasoline or find a drop of oil/fuel residue on the muffler when you unpack the unit.

### ASSEMBLY

Your saw is fully assembled; no assembly is necessary.

## OPERATION

### KNOW YOUR CHAIN SAW

READ THIS OPERATOR'S MANUAL AND SAFETY RULES BEFORE OPERATING YOUR CHAIN SAW. Compare the illustrations with your unit to familiarize yourself with the location of the various controls and adjustments. Save this manual for future reference.

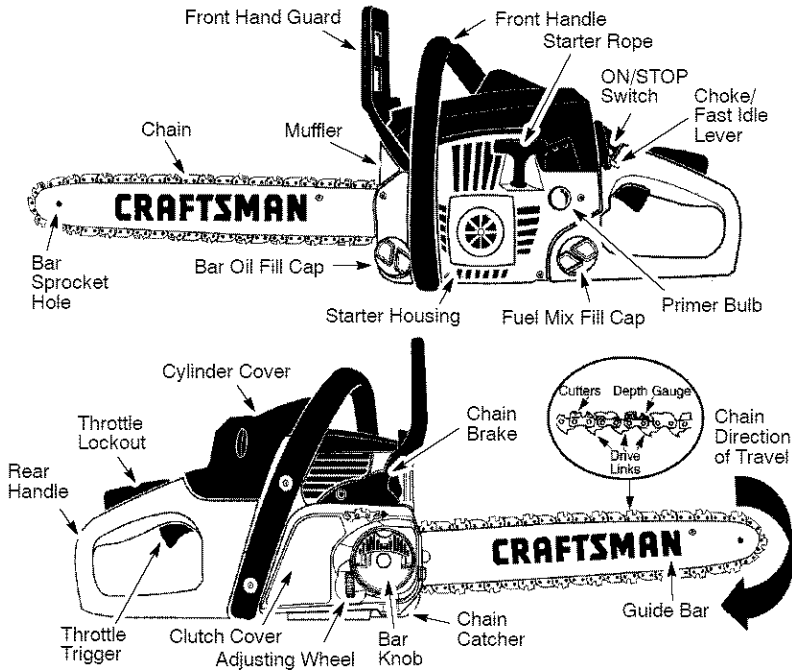

#### ON/STOP SWITCH

The ON/STOP SWITCH is used to stop the engine.

#### THROTTLE TRIGGER

The THROTTLE TRIGGER controls engine speed.

#### THROTTLE LOCK-OUT

The THROTTLE LOCK-OUT must be pressed before you can squeeze the throttle trigger. This feature prevents you from accidentally squeezing the trigger.

#### CHOKE/FAST IDLE LEVER

The choke and fast idle are set by pulling the CHOKE/FAST IDLE LEVER out to the full extent for cold starting or after refueling. The choke provides additional fuel to the engine during cold starting.

#### PRIMER BULB

The PRIMER BULB circulates fuel to the carburetor to provide quicker starting.

#### CHAIN BRAKE

The CHAIN BRAKE is a device designed to stop the chain if kickback occurs. The chain brake activates automatically in the event of kickback. The chain brake activates manually if the front hand guard is pushed forward. The chain brake is disengaged by pulling the front hand guard back toward the front handle as far as possible.

#### CHAIN TENSION

It is normal for a new chain to stretch during the first 15 minutes of operation. You should check your chain tension each time before you start the chain saw. See CHAIN TENSION under the MAINTENANCE section.

**⚠ WARNING:** If the saw is operated with a loose chain, the chain could jump off the guide bar and result in serious injury to the operator and/or damage the chain making it unusable.

## BEFORE STARTING ENGINE

**⚠ WARNING:** Muffler is very hot during and after use. Do not touch the muffler or allow combustible material such as dry grass or fuel to do so.

**⚠ WARNING:** Be sure to read the fuel handling information in the safety rules section of this manual before you begin. If you do not understand the fuel handling information do not attempt to fuel your unit. Seek help from someone that does understand the information or call the customer assistance help line at 1-800-235-5878.

### GUIDE BAR AND CHAIN OIL

The bar and chain require lubrication. The chain oiler provides continuous lubrication to the chain and guide bar. Be sure to fill the bar oil tank when you fill the fuel tank (Capacity = 6.8 fl. oz.). Lack of oil will quickly ruin the bar and chain. Too little oil will cause overheating shown by smoke coming from the chain and/or discoloration of the bar. For maximum guide bar and chain life, we recommend you use Craftsman chain saw bar oil. If Craftsman bar oil is not available, you may use a good grade SAE 30 oil until you are able to obtain Craftsman brand. The oil output is automatically metered during operation. Your saw will use approximately one tank of bar oil for every tank of fuel mix. Always fill the bar oil tank when you fill the fuel tank.

### FUELING ENGINE

**⚠ WARNING:** Remove fuel cap slowly when refueling. This engine is certified to operate on unleaded gasoline. Before operation, gasoline must be mixed with a good quality synthetic 2-cycle air-cooled engine oil. We recommend Craftsman brand synthetic oil. Mix gasoline and oil at a ratio of 40:1. A 40:1 ratio is obtained by mixing 3.2 ounces of oil with 1 gallon of unleaded gasoline. Included with this saw is a 3.2 ounce container of oil. Pour the entire contents of this container into 1 gallon of gasoline to achieve the proper fuel mixture. DO NOT USE automotive or boat oil. These oils will cause engine damage. When mixing fuel follow the instructions printed on the oil container. Once

oil is added to the gasoline, shake container momentarily to assure that the fuel is thoroughly mixed. Always read and follow the safety rules relating to fuel before fueling your unit.

### IMPORTANT

Experience indicates that alcohol-blended fuels (called gasohol or using ethanol or methanol) can attract moisture which leads to separation and formation of acids during storage. Acidic gas can damage the fuel system of an engine while in storage. To avoid engine problems, the fuel system should be emptied before storage for 30 days or longer. Drain the gas tank, start the engine and let it run until the fuel lines and carburetor are empty. Use fresh fuel next season. Never use engine or carburetor cleaner products in the fuel tank or permanent damage may occur. See the STORAGE section for additional information

### CHAIN BRAKE

Ensure chain brake is disengaged by pulling the front hand guard back toward the front handle as far as possible. The chain brake must be disengaged before cutting with the saw.

**⚠ WARNING:** The chain must not move when the engine runs at idle speed. If the chain moves at idle speed refer to CARBURETOR ADJUSTMENT within this manual. Avoid contact with the muffler. A hot muffler can cause serious burns.

### STOPPING YOUR ENGINE

- Release the throttle trigger.
- Move ON/STOP switch to the STOP position.

### STARTING POSITION

- To start the engine, hold the saw firmly on the ground as illustrated. Make sure the chain is free to turn without contacting any object.  
Starter Rope Handle

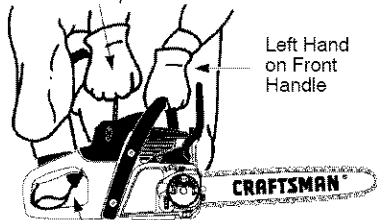

Right Foot Through Rear Handle



**⚠ WARNING:** Do not attempt to throw or drop—start the chain saw. Doing so will put the operator at risk of serious injury due to loss of control of the chain saw.

**IMPORTANT POINTS TO REMEMBER**

When pulling the starter rope, do not use the full extent of the rope as this can cause the rope to break. Do not let starter rope snap back. Hold the handle and let the rope rewind slowly.

For cold weather starting, start the unit at FULL CHOKE; allow the engine to warm up before squeezing the throttle trigger.

**NOTE:** Do not attempt to cut material with the choke/fast idle lever in the FULL CHOKE position.

**STARTING A COLD ENGINE (or warm engine after running out of fuel)**

**NOTE:** In the following steps, when the choke/fast idle lever is pulled out to the full extent, the correct throttle setting for starting is set automatically.

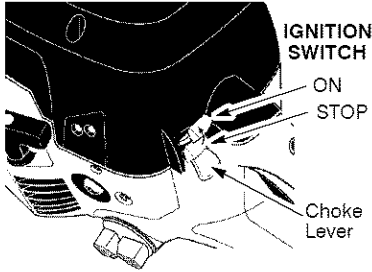

1. Move ON/STOP switch to the ON position.
2. Pull choke/fast idle lever out to the full extent (to the FULL CHOKE position).
3. Slowly press primer bulb 6 times.
4. Pull the starter rope sharply 5 times with your right hand. Then, proceed to the next step.

**NOTE:** If the engine sounds as if it is trying to start before the 5th pull, stop pulling and immediately proceed to the next step.

5. Push the choke/fast idle lever in to the HALF CHOKE position.

**CHOKE/FAST IDLE LEVER**

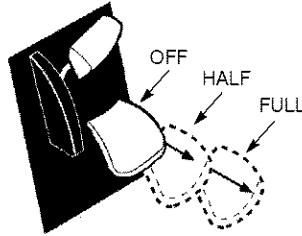

6. Pull the starter rope sharply with your right hand until the engine starts.
7. Allow the engine to run for approximately 30 seconds. Then, squeeze and release the throttle trigger to allow engine to return to idle speed.

**STARTING A WARM ENGINE**

1. Move ON/STOP switch to the ON position.
2. Pull the choke/fast idle lever out to the FULL CHOKE position to set the fast idle, then push the lever in to the HALF CHOKE position.
3. Slowly press primer bulb 6 times.
4. Pull the starter rope sharply with your right hand until the engine starts.
5. Squeeze and release throttle trigger to allow engine to return to idle speed.

**DIFFICULT STARTING (or starting a flooded engine)**

The engine may be flooded with too much fuel if it has not started after 10 pulls.

Flooded engines can be cleared of excess fuel by pushing the choke/fast idle lever in completely (to the OFF CHOKE position) and then following the warm engine starting procedure listed above. Ensure the ON/STOP switch is in the ON position.

Starting could require pulling the starter rope handle many times depending on how badly the unit is flooded. If engine fails to start, refer to the TROUBLESHOOTING TABLE or call 1-800-235-5878.

## CHAIN BRAKE

**⚠ WARNING:** If the brake band is worn too thin it may break when the chain brake is triggered. With a broken brake band, the chain brake will not stop the chain. The chain brake must be replaced if any part is worn to less than 0.020" (0.5 mm) thick. Repairs on a chain brake should be made by your Sears Service Center. Take your unit to the place of purchase or to the nearest Sears Service Center.

- This saw is equipped with a chain brake. The brake is designed to stop the chain if kickback occurs.
- The inertia-activated chain brake is activated if the front hand guard is pushed forward, either manually (by hand) or automatically (by sudden movement).
- If the brake is already activated, it is disengaged by pulling the front hand guard back toward the front handle as far as possible.
- When cutting with the saw, the chain brake must be disengaged.

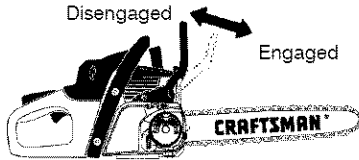

### Braking function control

**CAUTION:** The chain brake must be checked several times daily. The engine must be running when performing this procedure. This is the only instance when the saw should be placed on the ground with the engine running.

Place the saw on firm ground. Grip the rear handle with your right hand and the front handle with your left hand. Apply full throttle by fully depressing the throttle trigger. Activate the chain brake by turning your left wrist against the hand guard without releasing your grip around the front handle. The chain should stop immediately.

### Inertia activating function control

**⚠ WARNING:** When performing the following procedure, the engine must be turned off. Grip the rear handle with your right hand and the front handle with your left hand.

Hold the chain saw approximately 14 inches (35 cm) above a stump or other wooden surface. Release your grip on the front handle and use the weight of the saw to let the top of the guide bar fall forward and contact the stump. When the tip of the bar hits the stump, the brake should activate.

### OPERATING TIPS

- Check chain tension before first use and after 1 minute of operation, and each time before you start the chain saw. See CHAIN TENSION in the MAINTENANCE section.
- Cut wood only. Do not cut metal, plastics, masonry, non-wood building materials, etc.
- Stop the saw if the chain strikes a foreign object. Inspect the saw and repair or replace parts as necessary. If the chain jumps off the guide bar, inspect the chain for damaged drive links before reinstalling. Burrs on drive links, which prevent them from entering the groove of the guide bar, can be removed with a flat file.
- Keep the chain out of dirt and sand. Even a small amount of dirt will dull a chain, increase the possibility of kickback, and require chain sharpening or replacement.
- Practice cutting a few small logs using the following techniques to get the "feel" of using your saw before you begin a major sawing operation.
  - Squeeze the throttle trigger and allow the engine to reach full speed before cutting.
  - Begin cutting with the saw frame against the log.
  - Keep the engine at full speed the entire time you are cutting.
  - Allow the chain to cut for you. Exert only light downward pressure. If you force the cut, damage to the bar, chain, or engine can result.
  - Release the throttle trigger as soon as the cut is completed, allowing the engine to idle. If you run the saw at full throttle without a cutting load, unnecessary wear can occur to the chain, bar, and engine. **To maximize operating efficiency, do not run the engine for longer than 30 seconds at a time at full throttle.**
  - To avoid losing control when cut is complete, do not put pressure on saw at end of cut.
- Stop the engine before setting the saw down after cutting.

## TREE FELLING TECHNIQUES

**⚠ WARNING:** Check for broken or dead branches which can fall while cutting causing serious injury. Do not cut near buildings or electrical wires if you do not know the direction of tree fall, nor cut at night since you will not be able to see well, nor during bad weather such as rain, snow, or strong winds, etc. If the tree makes contact with any utility line, the utility company should be notified immediately.

- Carefully plan your sawing operation in advance.
- Clear the work area. You need a clear area all around the tree so you can have secure footing.
- The chain saw operator should keep on the uphill side of the terrain as the tree is likely to roll or slide downhill after it is felled.
- Study the natural conditions that can cause the tree to fall in a particular direction.

Natural conditions that can cause a tree to fall in a particular direction include:

- The wind direction and speed.
- The lean of the tree. The lean of a tree might not be apparent due to uneven or sloping terrain. Use a plumb or level to determine the direction of tree lean.
- Weight and branches on one side.
- Surrounding trees and obstacles. Look for decay and rot. If the trunk is rotted, it can snap and fall toward the operator. Check for broken or dead branches which can fall on you while cutting. Make sure there is enough room for the tree to fall. Maintain a distance of 2-1/2 tree lengths from the nearest person or other objects. Engine noise can drown out a warning call.

Remove dirt, stones, loose bark, nails, staples, and wire from the tree where cuts are to be made.

Plan a clear retreat path to the rear and diagonal to the line of fall.

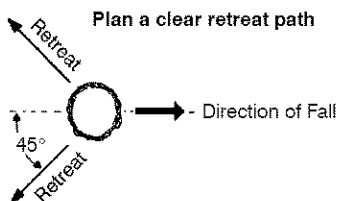

## FELLING LARGE TREES

(6 inches (15 cm) in diameter or larger)

The notch method is used to fell large trees. A notch is cut on the side of the tree in the desired direction of fall. After a felling cut is made on the opposite side of tree, the tree will tend to fall into the notch.

**NOTE:** If the tree has large buttress roots, remove them before making the notch. If using saw to remove buttress roots, keep saw chain from contacting ground to prevent dulling of the chain.

### NOTCH CUT AND FELLING THE TREE

- Make notch cut by cutting the top of the notch first. Cut through 1/3 of the diameter of the tree. Next complete the notch by cutting the bottom of the notch. See illustration. Once the notch is cut remove the notch of wood from the tree.

Final (felling) cut here, 2 inches (5 cm) above center of notch.

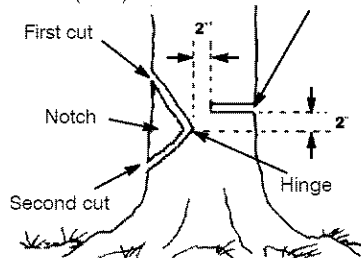

- After removing the wood from the notch, make the felling cut on the opposite side of the notch. This is done by making a cut about two inches (5 cm) higher than the center of the notch. This will leave enough uncut wood between the felling cut and the notch to form a hinge. This hinge will help prevent the tree from falling in the wrong direction.

**Hinge holds tree on stump and helps control fall**

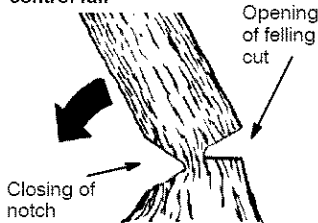

**NOTE:** Before felling cut is complete, use wedges to open the cut if necessary to control the direction of fall. To avoid

kickback and chain damage, use wood or plastic wedges, but never steel or iron wedges.

- Be alert to signs that the tree is ready to fall: cracking sounds, widening of the felling cut, or movement in the upper branches.
- As tree starts to fall, stop saw, put it down, and get away quickly on your planned retreat path.
- DO NOT cut down a partially fallen tree with your saw. Be extremely cautious with partially fallen trees that may be poorly supported. When a tree doesn't fall completely, set the saw aside and pull down the tree with a cable winch, block and tackle, or tractor.

### CUTTING A FALLEN TREE (BUCKING)

Bucking is the term used for cutting a fallen tree to the desired log size.

**⚠ WARNING:** Do not stand on the log being cut. Any portion can roll causing loss of footing and control. Do not stand downhill of the log being cut.

#### IMPORTANT POINTS

- Cut only one log at a time.
- Cut shattered wood very carefully; sharp pieces of wood could be flung toward operator.
- Use a sawhorse to cut small logs. Never allow another person to hold the log while cutting and never hold the log with your leg or foot.
- Do not cut in an area where logs, limbs, and roots are tangled such as in a blown down area. Drag the logs into a clear area before cutting by pulling out exposed and cleared logs first.

### TYPES OF CUTTING USED FOR BUCKING

**⚠ WARNING:** If saw becomes pinched or hung in a log, don't try to force it out. You can lose control of the saw resulting in injury and/or damage to the saw. Stop the saw, drive a wedge of plastic or wood into the cut until the saw can be removed easily. Restart the saw and carefully reenter the cut. To avoid kickback and chain damage, do not use a metal wedge. Do not attempt to restart your saw when it is pinched or hung in a log.

### Use a wedge to remove pinched saw



Turn saw OFF and use a plastic or wooden wedge to force cut open.

**Overcutting** begins on the top side of the log with the bottom of the saw against the log. When overcutting use light downward pressure.



Overcutting



Undercutting

**Undercutting** involves cutting on the underside of the log with top of saw against the log. When undercutting use light upward pressure. Hold saw firmly and maintain control. The saw will tend to push back toward you.

**⚠ WARNING:** Never turn saw upside down to undercut. The saw cannot be controlled in this position. Always make your first cut on the compression side of the log. The compression side of the log is where the pressure of the log's weight is concentrated.

First cut on compression side of log

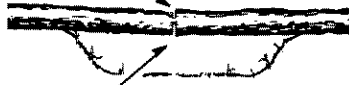

Second cut

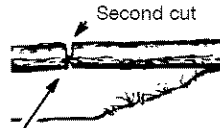

Second cut

First cut on compression side of log

### BUCKING WITHOUT A SUPPORT

- Overcut through 1/3 of the diameter of the log.
- Roll the log over and finish with a second overcut.
- Watch for logs with a compression side to prevent the saw from pinching. See illustrations for cutting logs with a compression side.

### BUCKING USING A LOG OR SUPPORT STAND

- Remember your first cut is always on the compression side of the log. (Refer to the illustrations below for your first and second cut)

- Your first cut should extend 1/3 of the diameter of the log.
- Finish with your second cut.

#### Using a log for support

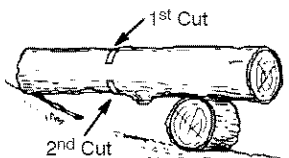
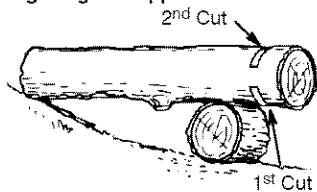

#### Using a support stand

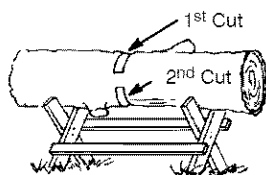
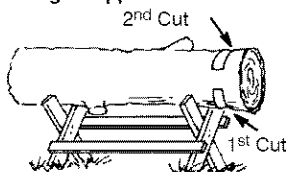

#### LIMBING AND PRUNING

**⚠ WARNING:** Be alert for and guard against kickback. Do not allow the moving chain to contact any other branches or objects at the nose of the guide bar when limbing or pruning. Allowing such contact can result in serious injury.

**⚠ WARNING:** Never climb into a tree to limb or prune. Do not stand on ladders, platforms, a log, or in any position which can cause you to lose your balance or control of the saw.

#### IMPORTANT POINTS

- Work slowly, keeping both hands firmly gripped on the saw. Maintain secure footing and balance.

- Watch out for springpoles. Springpoles are small size limbs which can catch the saw chain and whip toward you or pull you off balance. Use extreme caution when cutting small size limbs or slender material.
- Be alert for springback. Watch out for branches that are bent or under pressure. Avoid being struck by the branch or the saw when the tension in the wood fibers is released.
- Keep a clear work area. Frequently clear branches out of the way to avoid tripping over them.

#### LIMBING

- Always limb a tree after it is cut down. Only then can limbing be done safely and properly.
- Leave the larger limbs underneath the felled tree to support the tree as you work.
- Start at the base of the felled tree and work toward the top, cutting branches and limbs. Remove small limbs with one cut.
- Keep the tree between you and the chain. Cut from the side of the tree opposite the branch you are cutting.
- Remove larger, supporting branches with the cutting techniques described in BUCKING WITHOUT A SUPPORT.
- Always use an overcut to cut small and freely hanging limbs. Undercutting could cause limbs to fall and pinch the saw.

#### PRUNING

- ⚠ WARNING:** Limit pruning to limbs shoulder height or below. Do not cut if branches are higher than your shoulder. Get a professional to do the job.
- Make your first cut 1/3 of the way through the bottom of the limb.
  - Next make a 2nd cut **all the way through the limb**. Then cut a third overcut leaving a 1 to 2 inch (2.5 to 5 cm) collar from the truck of the tree.

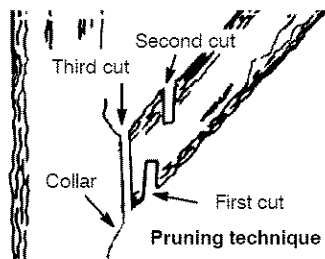

# MAINTENANCE

## CUSTOMER RESPONSIBILITIES

**⚠ WARNING:** Disconnect the spark plug before performing maintenance except for carburetor adjustments.

Fill in dates as you complete regular service	Before Use	After Use	Every 5 hrs.	Every 25 hrs.	Yearly	Service Dates
Check for damaged/worn parts	✓					
Check for loose fasteners/parts	✓					
Check chain tension	✓					
Check chain sharpness	✓					
Check guide bar	✓					
Check fuel mixture level	✓					
Check guide bar and chain oil	✓					
Inspect and clean unit & decals		✓				
Check chain brake			✓			
Clean guide bar groove			✓			
Clean air filter			✓			
Clean/inspect muffler and spark arresting screen				✓		
Replace spark plug and fuel filter					✓	

### GENERAL RECOMMENDATIONS

The warranty on this unit does not cover items that have been subjected to operator abuse or negligence. To receive full value from the warranty, the operator must maintain unit as instructed in this manual. Various adjustments will need to be made periodically to properly maintain your unit.

- Once a year, replace the spark plug, air filter, and check guide bar and chain for wear. A new spark plug and air filter assures proper air-fuel mixture and helps your engine run better and last longer.

### CHECK FOR DAMAGED OR WORN PARTS

Contact your Sears Service Center for replacement of damaged or worn parts.

**NOTE:** It is normal for a small amount of oil to appear under the saw after engine stops. Do not confuse this with a leaking oil tank.

- ON/STOP Switch - Ensure ON/STOP switch functions properly by moving the switch to the STOP position. Make sure engine stops; then restart engine and continue.

- Fuel Tank - Do not use saw if fuel tank shows signs of damage or leaks.
- Oil Tank - Do not use saw if oil tank shows signs of damage or leaks.

### CHECK FOR LOOSE FASTENERS AND PARTS

- Bar Knob
- Chain
- Muffler
- Cylinder Shield
- Air Filter
- Handle Screws
- Vibration Mounts
- Starter Housing
- Front Hand Guard

### CHECK CHAIN TENSION

**⚠ WARNING:** Wear protective gloves when handling chain. The chain is sharp and can cut you even when it is not moving.

Chain tension is very important. Chains stretch during use. This is especially true during the first few times you use your saw. Always check chain tension each time before you start the chain saw.

1. Use a screwdriver to move chain around guide bar to ensure kinks do not exist. The chain should rotate freely.

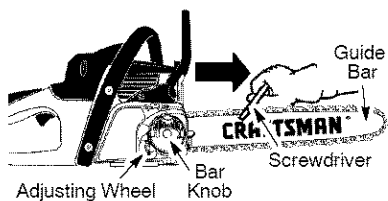

2. Lift lever on bar knob and turn counterclockwise 1 turn to loosen bar clamp.

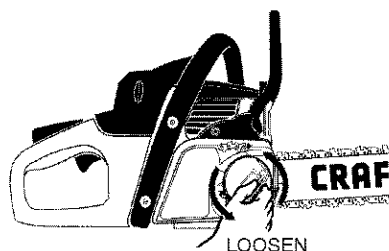

3. Turn adjusting wheel (downward direction) to tension chain until chain solidly contacts bottom of guide bar rail. Lift tip of guide bar while adjusting tension.

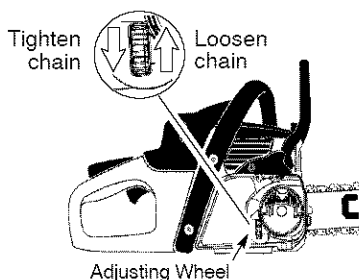

4. Using a screwdriver, move chain around guide bar to ensure all links are in bar groove.
5. While lifting tip of guide bar, tighten bar knob securely (clockwise). **Hand tighten only!**

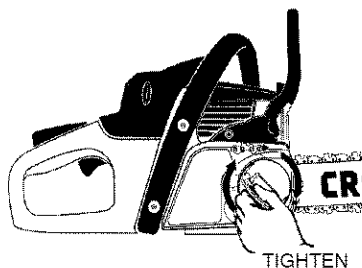
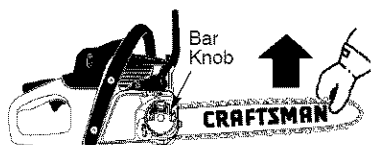

6. Push lever on bar knob down to return lever to closed/locked position.

**WARNING:** Failure to push lever on bar knob down to closed/locked position could result in serious personal injury or damage to your chain saw.

7. Use a screwdriver to move chain around guide bar.
8. If chain does not rotate, it is too tight. Loosen bar knob 1 turn (counterclockwise); then, loosen chain by turning the adjusting wheel  $\frac{1}{4}$  turn (upward direction). Retighten bar knob.
9. If chain is too loose, it will sag below the guide bar. **DO NOT** operate the saw if the chain is loose.

**NOTE:** The chain is tensioned correctly when the weight of the chain does not cause it to sag below the guide bar (with the chain saw sitting in an upright position), but the chain still moves freely around the guide bar.

**WARNING:** If the saw is operated with a loose chain, the chain could jump off the guide bar and result in serious injury to the operator and/or damage the chain making it unusable. If the chain jumps off the guide bar, inspect each drive link for damage. Damaged chain must be repaired or replaced.

#### CHECK CHAIN SHARPNESS

A sharp chain makes wood chips. A dull chain makes a sawdust powder and cuts slowly. See CHAIN SHARPENING.

#### CHECK GUIDE BAR

Conditions which require guide bar maintenance:

- Saw cuts to one side or at an angle.
  - Saw has to be forced through the cut.
  - Inadequate supply of oil to bar/chain.
- Check the condition of guide bar each time chain is sharpened. A worn guide bar will damage the chain and make cutting difficult.

After each use, ensure ON/STOP switch is in the STOP position, then clean all sawdust from the guide bar and sprocket hole.

To maintain guide bar:

- Move ON/STOP switch to STOP.
- Loosen and remove bar nuts and clutch cover. Remove bar and chain from saw.
- Clean the oil holes and bar groove after each 5 hours of operation.

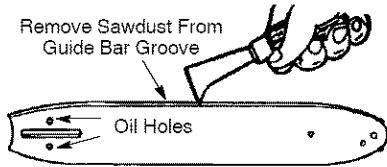

- Burring of guide bar rails is a normal process of rail wear. Remove these burrs with a flat file.
- When rail top is uneven, use a flat file to restore square edges and sides.

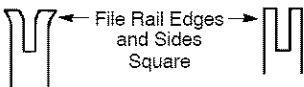

Replace guide bar when the groove is worn, the guide bar is bent or cracked, or when excess heating or burring of the rails occurs. If replacement is necessary, use only the guide bar specified for your saw in the repair parts list or on the decal located on the chain saw.

#### CHECK FUEL MIXTURE LEVEL

- See FUELING ENGINE under the OPERATION section.

#### LUBRICATION

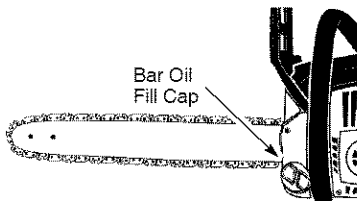

- See GUIDE BAR AND CHAIN OIL under the OPERATION section.

#### INSPECT AND CLEAN UNIT AND DECALS

- After each use, inspect complete unit for loose or damaged parts. Clean the unit and decals using a damp cloth with a mild detergent.
- Wipe off unit with a clean dry cloth.

#### CHECK CHAIN BRAKE

See CHAIN BRAKE in the OPERATION section.

#### CLEAN AIR FILTER

**CAUTION:** Do not clean filter in gasoline or other flammable solvent to avoid creating a fire hazard or producing harmful evaporative emissions.

#### Cleaning the air filter:

A dirty air filter decreases the life and performance of the engine and increases fuel consumption and harmful emissions. Always clean your air filter after 10 tanks of fuel or 5 hours of operation, whichever comes first. Clean more frequently in dusty conditions. A used air filter can never be completely cleaned. It is advisable to replace your air filter with a new one after every 50 hours of operation, or annually, whichever comes first.

1. Loosen 3 screws on cylinder cover.
2. Remove cylinder cover.
3. Remove air filter cover and air filter.
4. Clean the air filter using hot soapy water. Rinse with clean cool water. Air dry completely before reinstalling.
5. Reinstall air filter and air filter cover.
6. Reinstall cylinder cover and 3 screws. Tighten securely.

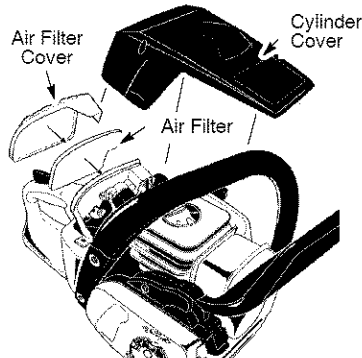

#### INSPECT MUFFLER AND SPARK ARRESTING SCREEN

**WARNING:** The muffler on this product contains chemicals known to the State of California to cause cancer. As the unit is used, carbon deposits build up on the muffler and spark arresting screen, and must be removed to avoid creating a fire hazard or affecting engine performance.



Replace the spark arresting screen if breaks occur.

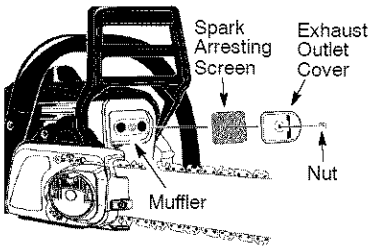

### CLEANING THE SPARK ARRESTING SCREEN

Cleaning is required every 25 hours of operation or annually, whichever comes first.

1. Loosen and remove the nut from the exhaust outlet cover.
2. Remove the exhaust outlet cover.
3. Remove spark arresting screen. Handle screen carefully to prevent damage.
4. Clean the spark arresting screen gently with a wire brush. Replace screen if breaks are found.
5. Replace any broken or cracked muffler parts.
6. Reinstall spark arresting screen, exhaust outlet cover, and nut. Tighten nut securely.

### REPLACE SPARK PLUG

The spark plug should be replaced each year to ensure the engine starts easier and runs better. Ignition timing is fixed and nonadjustable.

1. Loosen 3 screws on cylinder cover.
2. Remove the cylinder cover.
3. Pull off the spark plug boot.
4. Remove spark plug from cylinder and discard.
5. Replace with Champion RCJ-7Y spark plug and tighten securely with a  $\frac{3}{4}$  inch (19 mm) socket wrench. Spark plug gap should be 0.025 inch (0,6 mm).
6. Reinstall the spark plug boot.
7. Reinstall the cylinder cover and 3 screws. Tighten securely.

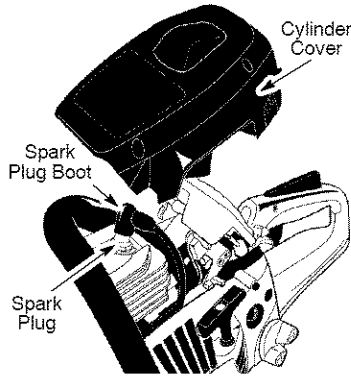

### REPLACE FUEL FILTER

To replace fuel filter, drain your unit by running it dry of fuel. Remove fuel cap and its connected retainer from tank. Pull filter from tank and remove from line. Replace and reassemble.

## SERVICE AND ADJUSTMENTS

**⚠ WARNING:** Disconnect the spark plug before performing maintenance, service, or adjustments except for carburetor adjustments.

### CHAIN SHARPENING

**⚠ WARNING:** Improper chain sharpening techniques and/or depth gauge maintenance will increase the chance of kickback which can result in serious injury.

**⚠ WARNING:** Wear protective gloves when handling chain. The chain is sharp and can cut you even when it is not moving.  
Conditions which indicate the need for chain sharpening:

- Reduction in size of wood chips. The size of the wood chip will decrease as the chain gets duller until it becomes more like a powder than a chip. Note that dead or rotted wood will not produce a good chip.
- Saw cuts to one side or at an angle.
- Saw has to be forced through the cut.

#### Tools required:

- 5/32 inch (4 mm) diameter round file and file holder
- Flat file
- Depth gauge tool

#### TO SHARPEN CHAIN:

1. Move ON/STOP switch to the STOP position.
2. Check chain for proper tension. Adjust chain tension if necessary. See CHAIN TENSION section.

### 3. Sharpen cutters.

- To sharpen the cutters, position the file holder level ( $90^\circ$ ) so that it rests on the top edges of the cutter and depth gauge.

**NOTE:** The chain has both left and right hand cutters.

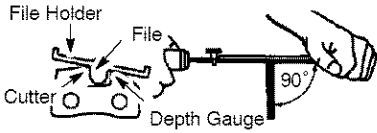

- Align the  $30^\circ$  file holder marks parallel with the bar and to the center of the chain.

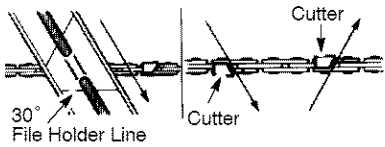

- Sharpen cutters on one side of the chain first. File from the inside of each cutter to the outside. Then, turn the chain saw around and repeat the process for the other side of the chain.
- File on the forward stroke only. use 2 or 3 strokes per cutting edge.
- Keep all cutters the same length when filing.
- File enough to remove any damage to cutting edges (side plate and top plate of cutter).

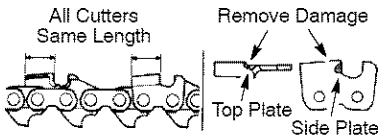

- File chain to meet the specifications as shown.

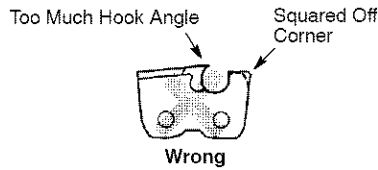
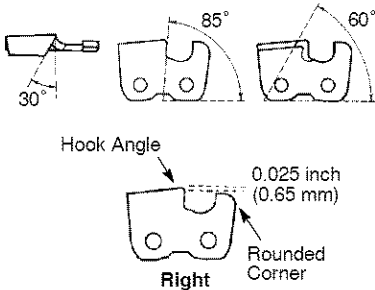

**WARNING:** Maintain the proper hook angle according to the manufacturer's specifications for the chain you are using. Improper hook angle will increase the chance of kickback which can result in serious injury.

### 4. Check and lower depth gauges.

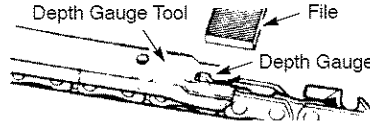

- Place gauge tool on cutter.
- If the depth gauge is higher than the depth gauge tool, file it level to the top of the depth gauge tool.
- Maintain rounded front corner of depth gauge with a flat file.

**NOTE:** The very top of the depth gauge should be flat with the front half rounded off with a flat file.

If you require further assistance or are unsure about performing this procedure, contact your Sears Service Center or call our customer assistance help line at 1-800-235-5878.

### CHAIN REPLACEMENT

**WARNING:** Wear protective gloves when handling chain. The chain is sharp and can cut you even when it is not moving.

It is normal for a new chain to stretch during the first 15 minutes of operation. You should recheck your chain tension each time before you start the chain saw and adjust the chain tension as required. See CHAIN TENSION section. Replace the old chain when it becomes worn or damaged. Use only the Low-Kickback replacement chain specified in the repair parts list. The correct replacement bar and chain is also specified on a decal located on the chain saw.

See your Sears Service Center to replace and sharpen individual cutters on your chain.

### TO REPLACE CHAIN:

1. Move ON/STOP switch to the STOP position.

2. Loosen and remove bar knob completely by lifting lever and turning counterclockwise.

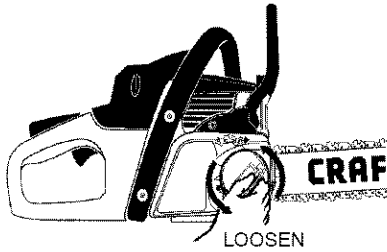

3. Loosen chain tension by turning adjusting wheel (upward direction). Remove clutch cover.

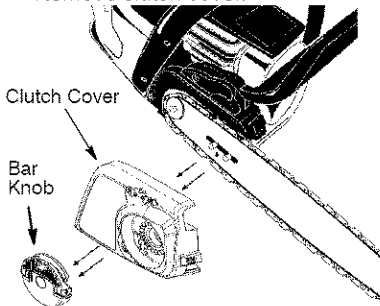

4. Slide guide bar on bar bolts until guide bar stops against clutch drum sprocket.

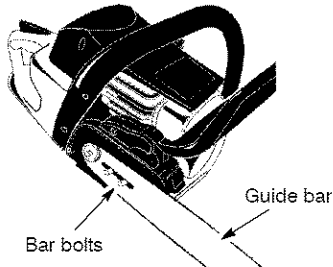

5. Remove the old chain.
6. Carefully remove the chain from the package. Hold chain with the drive links as shown.

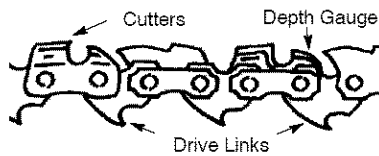
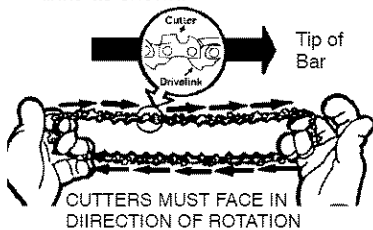

7. Place chain over and behind clutch retainer, fitting the drive links in the clutch drum sprocket.
8. Fit bottom of drive links between the teeth in the sprocket in the nose of the guide bar.
9. Fit chain drive links into bar groove.
10. Pull guide bar forward until chain is snug in guide bar groove. Ensure all drive links are in the bar groove.
11. Install clutch cover. Be sure adjusting pin is in the adjusting pin hole in the guide bar.

**CAUTION:** It is very important when installing the clutch cover that the adjusting pin aligns into the adjusting pin hole in the bar. Failure to install the clutch cover correctly may result in permanent damage to your chain saw.

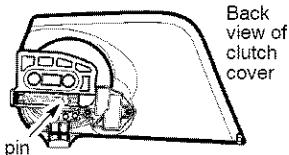

12. Install bar knob and finger tighten only. Do not tighten any further at this point. Proceed to CHAIN ADJUSTMENT.

#### CHAIN ADJUSTMENT

See CHECK CHAIN TENSION in MAINTENANCE section.

#### CARBURETOR ADJUSTMENT

**WARNING:** The chain will be moving during most of this procedure. Wear your protective equipment and observe all safety precautions. The chain must not move at idle speed. The carburetor has been carefully set at the factory. Adjustments may be necessary if you notice any of the following conditions:

- Chain moves at idle. See IDLE SPEED-T adjusting procedure.
- Saw will not idle. See IDLE SPEED-T adjusting procedure.

### Idle Speed-T

Allow engine to idle. If the chain moves, idle is too fast. If the engine stalls, idle is too slow. Adjust speed until engine runs without chain movement (idle too fast) or stalling (idle too slow). The idle speed screw is located in the area above the primer bulb and is labeled T.

- Turn idle screw (T) clockwise to increase engine speed.
- Turn idle screw (T) counterclockwise to decrease engine speed.

If you require further assistance or are unsure about performing this procedure, contact your Sears Service Center or call our customer assistance help line at 1-800-235-5878.

## STORAGE

**⚠ WARNING:** Perform the following steps after each use:

- Allow the engine to cool, and secure the unit before storing or transporting.
- Store chain saw and fuel in a well ventilated area where fuel vapors cannot reach sparks or open flames from water heaters, electric motors or switches, furnaces, etc.
- Store chain saw with all guards in place and position chain saw so that any sharp object cannot accidentally cause injury.
- Store chain saw well out of the reach of children.

### SEASONAL STORAGE

Prepare your unit for storage at the end of the season or if it will not be used for 30 days or more.

If your chain saw is to be stored for a period of time:

- Clean saw thoroughly before storage.
- Store in a clean dry area.
- Lightly oil external metal surfaces and guide bar.
- Oil the chain and wrap it in heavy paper or cloth.

### FUEL SYSTEM

Empty the fuel system before storage for 30 days or longer. Drain the gas tank, start the engine and let it run until the fuel lines and carburetor are empty. Use fresh fuel next season.

Under FUELING ENGINE in the OPERATION section of this manual, see message labeled **IMPORTANT** regarding the use of gasohol in your chain saw. Fuel stabilizer is an acceptable alternative in minimizing the formation of fuel gum deposits during storage. Add stabilizer to the gasoline in the fuel tank or fuel storage container. Follow the mix instructions found on stabilizer containers. Run engine at least 3 minutes after adding stabilizer. Craftsman 40:1, 2-cycle engine oil (air cooled) is blended with fuel stabilizer. If you do not use this oil, you can add a fuel stabilizer to your fuel tank.

### ENGINE

- Remove spark plug and pour 1 teaspoon of 40:1, 2-cycle engine oil (air cooled) through the spark plug opening. Slowly pull the starter rope 8 to 10 times to distribute oil.
- Replace spark plug with new one of recommended type and heat range.
- Clean air filter.
- Check entire unit for loose screws, nuts, and bolts. Replace any damaged, broken, or worn parts.
- At the beginning of the next season, use only fresh fuel having the proper gasoline to oil ratio.

### OTHER

- Do not store gasoline from one season to another.
- Replace your gasoline can if it starts to rust.

## TROUBLESHOOTING TABLE

**⚠ WARNING:** Always stop unit and disconnect spark plug before performing all of the recommended remedies below except remedies that require operation of the unit.

TROUBLE	CAUSE	REMEDY
Engine will not start or will run only a few seconds after starting.	<ol style="list-style-type: none"> <li>ON/STOP switch in STOP position.</li> <li>Engine flooded.</li> <li>Fuel tank empty.</li> <li>Spark plug not firing.</li> <li>Fuel not reaching carburetor.</li> <li>Carburetor requires adjustment.</li> <li>None of the above.</li> </ol>	<ol style="list-style-type: none"> <li>Move ON/STOP switch to ON.</li> <li>See "Difficult Starting" in the Operation Section.</li> <li>Fill tank with correct fuel mixture.</li> <li>Install new spark plug.</li> <li>Check for dirty fuel filter; replace. Check for kinked or split fuel line; repair or replace.</li> <li>Contact Sears Service (see back cover).</li> <li>Contact Sears Service (see back cover).</li> </ol>
Engine will not idle properly.	<ol style="list-style-type: none"> <li>Idle speed set too high or too low.</li> <li>Low Speed Mixture requires adjustment.</li> <li>Crankshaft seals worn.</li> <li>Compression low.</li> <li>None of the above.</li> </ol>	<ol style="list-style-type: none"> <li>See "Carburetor Adjustment" in the Service and Adjustments Section.</li> <li>Contact Sears Service (see back cover).</li> <li>Contact Sears Service (see back cover).</li> <li>Contact Sears Service (see back cover).</li> <li>Contact Sears Service (see back cover).</li> </ol>
Engine will not accelerate, lacks power, or dies under a load.	<ol style="list-style-type: none"> <li>Air filter dirty.</li> <li>Spark plug fouled.</li> <li>Carburetor requires adjustment.</li> <li>Exhaust ports or muffler outlets plugged.</li> <li>Compression low.</li> <li>Chain brake engaged.</li> <li>None of the above.</li> </ol>	<ol style="list-style-type: none"> <li>Clean or replace air filter.</li> <li>Clean or replace plug and regap.</li> <li>Contact Sears Service (see back cover).</li> <li>Contact Sears Service (see back cover).</li> <li>Contact Sears Service (see back cover).</li> <li>Disengage chain brake.</li> <li>Contact Sears Service (see back cover).</li> </ol>
Engine smokes excessively.	<ol style="list-style-type: none"> <li>Choke partially on.</li> <li>Fuel mixture incorrect.</li> <li>Air filter dirty.</li> <li>High Speed Mixture requires adjustment.</li> <li>Crankcase leak.</li> </ol>	<ol style="list-style-type: none"> <li>Adjust choke.</li> <li>Empty fuel tank and refill with correct fuel mixture.</li> <li>Clean or replace air filter.</li> <li>Contact Sears Service (see back cover).</li> <li>Contact Sears Service (see back cover).</li> </ol>
Engine runs hot.	<ol style="list-style-type: none"> <li>Fuel mixture incorrect.</li> <li>Spark plug incorrect.</li> <li>High Speed Mixture set too lean.</li> <li>Exhaust ports or muffler outlets plugged.</li> <li>Carbon build-up on spark arresting screen.</li> <li>Starter housing dirty</li> <li>None of the above.</li> </ol>	<ol style="list-style-type: none"> <li>See "Fueling Engine" in the Operation section.</li> <li>Replace with correct plug.</li> <li>Contact Sears Service (see back cover).</li> <li>Contact Sears Service (see back cover).</li> <li>Clean spark arresting screen.</li> <li>Clean starter housing area.</li> <li>Contact Sears Service (see back cover).</li> </ol>
Oil inadequate for bar and chain lubrication.	<ol style="list-style-type: none"> <li>Oil tank empty.</li> <li>Oil pump or oil filter clogged.</li> <li>Guide bar oil hole blocked.</li> </ol>	<ol style="list-style-type: none"> <li>Fill oil tank.</li> <li>Contact Sears Service (see back cover).</li> <li>Remove bar and clean.</li> </ol>
Chain moves at idle speed.	<ol style="list-style-type: none"> <li>Idle speed requires adjustment.</li> <li>Clutch requires repair.</li> </ol>	<ol style="list-style-type: none"> <li>See "Carburetor Adjustment" in the Service and Adjustments Section.</li> <li>Contact Sears Service (see back cover).</li> </ol>

## TROUBLESHOOTING TABLE - Continued

TROUBLE	CAUSE	REMEDY
Chain does not move when engine is accelerated.	<ol style="list-style-type: none"> <li>1. Chain tension too tight.</li> <li>2. Carburetor requires adjustment.</li> <li>3. Guide bar rails pinched.</li> <li>4. Clutch slipping.</li> <li>5. Chain brake engaged.</li> </ol>	<ol style="list-style-type: none"> <li>1. See "Check Chain Tension" in the Maintenance Section.</li> <li>2. Contact Sears Service (see back cover).</li> <li>3. Repair or replace.</li> <li>4. Contact Sears Service (see back cover).</li> <li>5. Disengage chain brake.</li> </ol>
Chain clatters or cuts roughly.	<ol style="list-style-type: none"> <li>1. Chain tension incorrect.</li> <li>2. Cutters damaged.</li> <li>3. Chain worn.</li> <li>4. Cutters dull, improperly sharpened, or depth gauges too high.</li> <li>5. Sprocket worn.</li> <li>6. Chain installed backwards.</li> </ol>	<ol style="list-style-type: none"> <li>1. See "Check Chain Tension" in the Maintenance Section.</li> <li>2. Contact Sears Service (see back cover).</li> <li>3. Resharpener or replace chain.</li> <li>4. See "Chain Sharpening" in the Service and Adjustments Section.</li> <li>5. Contact Sears Service (see back cover).</li> <li>6. Install chain in right direction.</li> </ol>
Chain stops within the cut.	<ol style="list-style-type: none"> <li>1. Chain cutter tops not filed flat.</li> <li>2. Guide bar burred or bent; rails uneven.</li> <li>3. Clutch slipping.</li> </ol>	<ol style="list-style-type: none"> <li>1. See "Chain Sharpening" in the Service and Adjustments Section.</li> <li>2. Repair or replace guide bar.</li> <li>3. Contact Sears Service (see back cover).</li> </ol>
Chain cuts at an angle.	<ol style="list-style-type: none"> <li>1. Cutters damaged on one side.</li> <li>2. Chain dull on one side.</li> <li>3. Guide bar bent or worn.</li> </ol>	<ol style="list-style-type: none"> <li>1. See "Chain Sharpening" in the Service and Adjustments Section.</li> <li>2. See "Chain Sharpening" in the Service and Adjustments Section.</li> <li>3. Replace guide bar.</li> </ol>

If situations occur which are not covered in this manual, use care and good judgement. If you need assistance, contact Sears Service or the CUSTOMER ASSISTANCE HELPLINE at 1-800-235-5878.

## U.S. EPA/CALIFORNIA EMISSION CONTROL WARRANTY STATEMENT

### **YOUR WARRANTY RIGHTS AND**

**OBLIGATIONS:** The U.S. Environmental Protection Agency/California Air Resources Board and Sears, Roebuck and Co., U.S.A., are pleased to explain the emissions control system warranty on your year 2007 and later small off-road engine. In California, all small off-road engines must be designed, built, and equipped to meet the State's stringent anti-smog standards. Sears must warrant the emission control system on your small off-road engine for the periods of time listed below provided there has been no abuse, neglect, or improper maintenance of your small off-road engine. Your emission control system includes parts such as the carburetor, the ignition system and the fuel tank (California only). Where a warrantable condition exists, Sears will repair your small off-road engine engine at no cost to you. Expenses covered under warranty include diagnosis, parts and labor. **MANUFACTURER'S WARRANTY COVERAGE:** If any emissions related part on your engine (as listed under Emissions Control Warranty Parts List) is defective or a defect in the materials or workmanship of the engine causes the failure of such an emission related part, the part will be repaired or replaced by Sears.

**OWNER'S WARRANTY RESPONSIBILITIES:** As the small off-road engine engine owner, you are responsible for the performance of the required maintenance listed in your operator's manual. Sears recommends that you retain all receipts covering maintenance on your small off-road engine, but Sears cannot deny warranty solely for the lack of receipts or for your failure to ensure the performance of all scheduled maintenance. As the small off-road engine engine owner, you should be aware that Sears may deny you warranty coverage if your small off-road engine engine or a part of it has failed due to abuse, neglect, improper maintenance, unapproved modifications, or the use of parts not made or approved by the original equipment manufacturer. You are responsible for presenting your small

off-road engine to a Sears authorized repair center as soon as a problem exists. Warranty repairs should be completed in a reasonable amount of time, not to exceed 30 days. If you have any questions regarding your warranty rights and responsibilities, you should contact your nearest authorized service center or call Sears at 1-800-469-4663. **WARRANTY COMMENCEMENT DATE:** The warranty period begins on the date the small off-road engine is purchased.

**LENGTH OF COVERAGE:** This warranty shall be for a period of two years from the initial date of purchase.

**WHAT IS COVERED: REPAIR OR REPLACEMENT OF PARTS.** Repair or replacement of any warranted part will be performed at no charge to the owner at an approved Sears Service Center. If you have any questions regarding your warranty rights and responsibilities, you should contact your nearest authorized service center or call Sears at 1-800-469-4663. **WARRANTY PERIOD:** Any warranted part which is not scheduled for replacement as required maintenance, or which is scheduled only for regular inspection to the effect of "repair or replace as necessary" shall be warranted for 2 years. Any warranted part which is scheduled for replacement as required maintenance shall be warranted for the period of time up to the first scheduled replacement point for that part.

**DIAGNOSIS:** The owner shall not be charged for diagnostic labor which leads to the determination that a warranted part is defective if the diagnostic work is performed at an approved Sears Service Center. **CONSEQUENTIAL DAMAGES:** Sears may be liable for damages to other engine components caused by the failure of a warranted part still under warranty.

**WHAT IS NOT COVERED:** All failures caused by abuse, neglect, or improper maintenance are not covered. **ADD-ON OR MODIFIED PARTS:** The use of add-on or modified parts can be grounds for disallowing a warranty claim. Sears is not liable to cover fail-

ures of warranted parts caused by the use of add-on or modified parts.

**HOW TO FILE A CLAIM:** If you have any questions regarding your warranty rights and responsibilities, you should contact your nearest authorized service center or call Sears at 1-800-469-4663.

**WHERE TO GET WARRANTY SERVICE:** Warranty services or repairs shall be provided at all Sears Service Centers. Call 1-800-469-4663.

**MAINTENANCE, REPLACEMENT AND REPAIR OF EMISSION RELATED PARTS:** Any Sears approved replacement part

used in the performance of any warranty maintenance or repair on emission related parts will be provided without charge to the owner if the part is under warranty.

**EMISSION CONTROL WARRANTY PARTS LIST:**

spark plug (covered up to maintenance schedule), ignition module, muffler including catalyst (if equipped), fuel tank (California only).

**MAINTENANCE STATEMENT:** The owner is responsible for the performance of all required maintenance as defined in the operator's manual.

The information on the product label indicates which standard your engine is certified. Example: (Year) EPA Phase 1 or Phase 2 and/or CALIFORNIA.

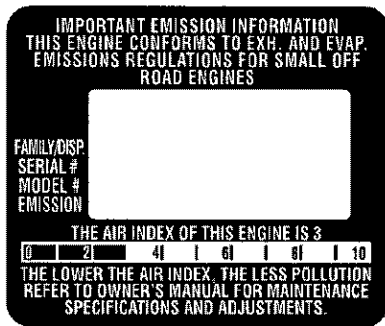

This engine is certified to be emissions compliant for the following use:

- Moderate (50 hours)
- Intermediate (125 hours)
- Extended (300 hours)



# REPAIR PARTS

SEARS CHAINSAW MODEL 358.351810

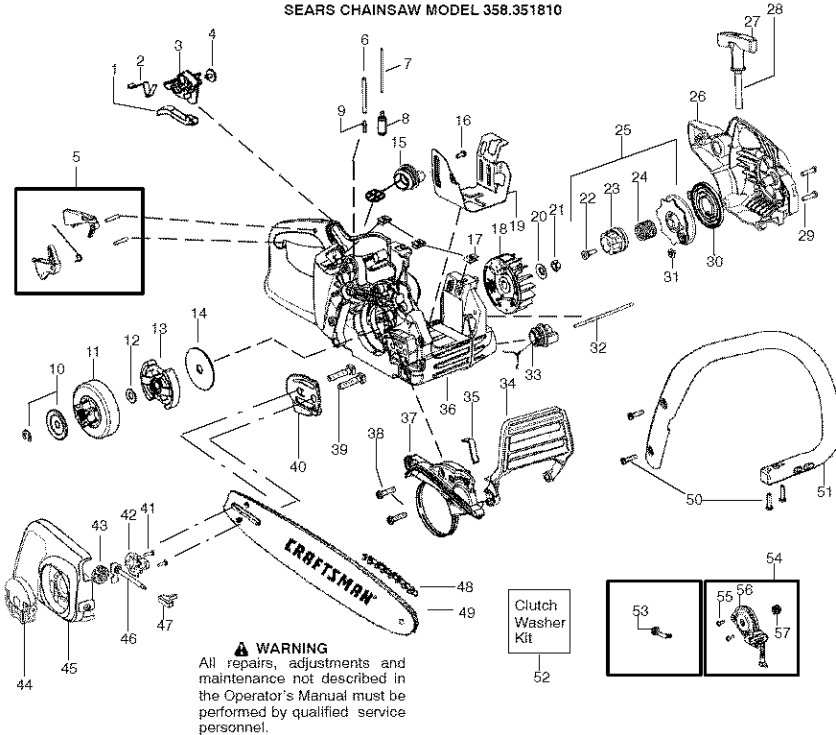

**WARNING**  
All repairs, adjustments and maintenance not described in the Operator's Manual must be performed by qualified service personnel.

Ref.	Part No.	Description	Ref.	Part No.	Description	Ref.	Part No.	Description
1.	530057893	Knob-Choke	22.	530021179	Screw-Shoulder	41.	530018064	Screw
2.	530057908	Spring-Ign. Switch	23.	530059677	Starter Hub- EPS	42.	530059999	Cover-Gearbox
3.	530057891	Lever-Ign. Switch	24.	530021180	Spring-EPS	43.	545039501	Wheel-Bar adjust
4.	530016080	Screw	25.	530071966	Kit-EPS starter pulley (Incl. 22,23,24,31)	44.	545040604	Assy-EZT knob
5.	530071888	Kit-Trigger/Lockout	26.	545039604	Housing-Fan	45.	545027614	Cover-EZT
6.	530069216	Kit-Fuel Line (large)	27.	530056402	Handle-Starter	46.	530150000	Assy-Adj. screw
7.	530069247	Kit-Fuel Line (small)	28.	530069232	Kit-Rope	47.	545157401	Pin-Bar Adjust
8.	530095649	Assy-Fuel Pick Up	29.	530016432	Screw	48.	71-3613	Chain 18"
9.	530023877	Fitting-Fuel Line	30.	530042095	Spring-Starter	49.	71-36638	Bar 18"
10.	530071945	Kit-Clutch Washer	31.	530018080	Screw	50.	530016432	Screw
11.	530057905	Assy-clutch drum 3/8"	32.	530058786	Assy-Oil Vent	51.	530057888	Handle-Front
12.	530071945	Kit-Clutch Washer	33.	530057236	Assy-Oil Cap w/ret.	52.	530071945	Kit-Clutch Washer (Incl. 10,12)
13.	530057907	Assy-Clutch	34.	530057897	Handguard	53.	530057924	Assy-Oil pick up
14.	530016419	Washer-Large Clutch	35.	530016416	Spring-Handguard	54.	530071891	Kit-Oil pump (Incl. 55,56,57)
15.	530047192	Assy-Fuel Cap wret.	36.	545026306	Assy-Chassis (Incl. ,5,6,7,8,9,15,16,17, ,19,32,33,35,39)	55.	530018064	Screw
16.	530018064	Screw				56.	530057931	Assy-Oil Pump
17.	530015922	Nut-"U" type speed	37.	530071893	Kit-Chainbrake	57.	530037820	Gear-Worm
18.	530059635	Assy-Flywheel	38.	530016432	Screw			
19.	530057911	Shield-Heat	39.	530016133	Bolt-Bar			
20.	530015127	Washer-Flywheel	40.	530057910	Plate-Bar			
21.	530016134	Nut-Flywheel						

