

OPERATOR'S MANUAL

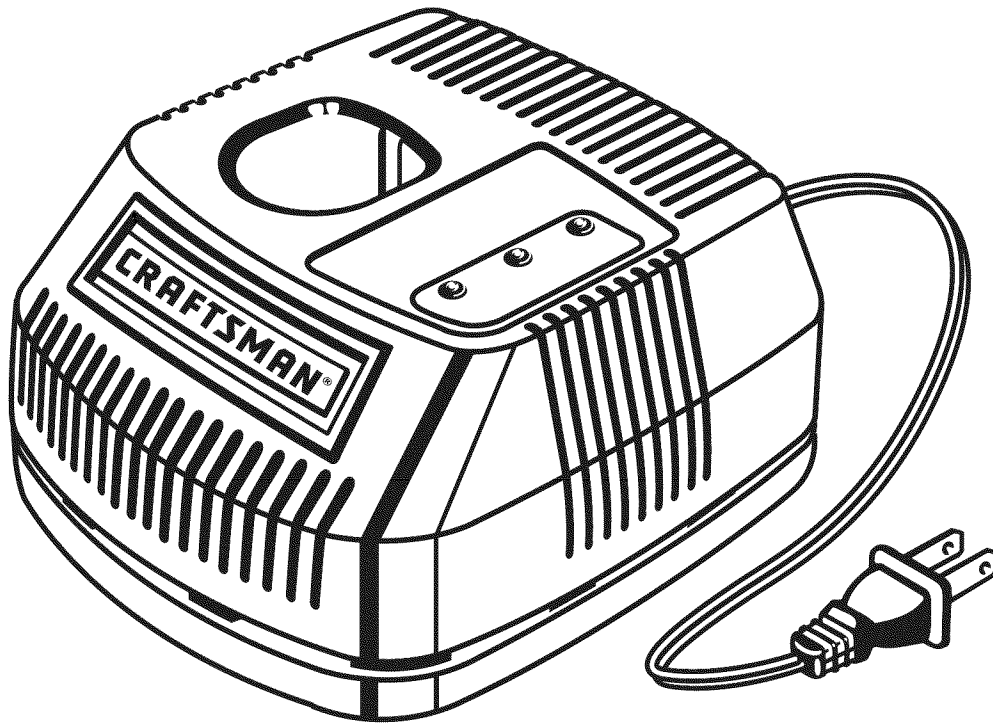

ONE HOUR UNIVERSAL BATTERY CHARGER

Item No. 911041
(1425301)



**For use with Craftsman EX and DieHard
7.2 Volt - 24 Volt battery packs**

BATTERIES SOLD SEPARATELY

⚠ WARNING: To reduce the risk of injury,
the user must read and understand the
operator's manual before using this
product.

Customer Help Line: 1-800-932-3188

Sears, Roebuck and Co., 3333 Beverly Rd., Hoffman Estates, IL 60179 USA
Visit the Craftsman web page: www.sears.com/craftsman



WARRANTY

ONE YEAR FULL WARRANTY ON CRAFTSMAN TOOL

If this Craftsman tool fails to give complete satisfaction within one year from date of purchase, **RETURN IT TO THE NEAREST SEARS STORE IN THE UNITED STATES**, and Sears will replace it, free of charge.

If this Craftsman tool is used for commercial or rental purposes, this warranty applies for only 90 days from the date of purchase.

This warranty gives you specific legal rights, and you may also have other rights which vary from state to state.

Sears, Roebuck and Co., Dept. 817 WA, Hoffman Estates, IL 60179

SAFETY RULES FOR CHARGER

 **WARNING! READ AND UNDERSTAND ALL INSTRUCTIONS.** Failure to follow all instructions listed below, may result in electric shock, fire and/or serious personal injury.

- **Before using battery charger**, read all instructions and cautionary markings in this manual, on battery charger, battery, and product using battery to prevent misuse of the products and possible injury or damage.





 **CAUTION:** To reduce the risk of electric shock or damage to the charger and battery, charge only nickel-cadmium rechargeable batteries as specifically designated on your charger. Other types of batteries may burst, causing personal injury or damage.

- **Do not use charger outdoors or expose to wet or damp conditions.** Water entering charger will increase the risk of electric shock.
- **Use of an attachment not recommended or sold by the battery charger manufacturer may result in a risk of fire, electric shock, or injury to persons.** Following this rule will reduce the risk of electric shock, fire, or serious personal injury.
- **Do not abuse cord or charger.** Never use the cord to carry the charger. Do not pull the charger cord rather than the plug when disconnecting from receptacle. Damage to the cord or charger could occur and create an electric shock hazard. Replace damaged cords immediately.
- **Make sure cord is located so that it will not be stepped on, tripped over, come in contact with sharp edges or moving parts or otherwise subjected to damage or stress.** This will reduce the risk of accidental falls, which could cause injury, and damage to the cord, which could result in electric shock.

- **Keep cord and charger from heat to prevent damage to housing or internal parts.**
- **Do not let gasoline, oils, petroleum-based products, etc. come in contact with plastic parts.** They contain chemicals that can damage, weaken, or destroy plastic.
- **Do not operate charger with a damaged cord or plug**, which could cause shorting and electric shock. If damaged, have the charger replaced by an authorized serviceman.
- **Do not operate charger if it has received a sharp blow, been dropped, or otherwise damaged in any way.** Take it to an authorized serviceman for electrical check to determine if the charger is in good working order.
- **Do not disassemble charger.** Take it to an authorized serviceman when service or repair is required. Incorrect reassembly may result in a risk of electric shock or fire.
- **Unplug charger from outlet before attempting any maintenance or cleaning to reduce the risk of electric shock.**
- **Disconnect charger from the power supply when not in use.** This will reduce the risk of electric shock or damage to the charger if metal items should fall into the opening. It also will help prevent damage to the charger during a power surge.
- **Risk of electric shock.** Do not touch uninsulated portion of output connector or uninsulated battery terminal.
- **Save these instructions.** Refer to them frequently and use them to instruct others who may use this tool. If you loan someone this tool, loan them these instructions also to prevent misuse of the product and possible injury.

SYMBOLS

Some of the following symbols may be used on this tool. Please study them and learn their meaning. Proper interpretation of these symbols will allow you to operate the tool better and safer.

| SYMBOL | NAME | DESIGNATION/EXPLANATION |
|---|----------------------------|--|
|  | Wet Conditions Alert | Do not expose to rain or use in damp locations. |
|  | Read The Operator's Manual | To reduce the risk of injury, user must read and understand operator's manual before using this product. |
|  | Eye Protection | Always wear safety goggles or safety glasses with side shields, or a full face shield when operating this product. |
|  | Safety Alert | Precautions that involve your safety. |

FEATURES

PRODUCT SPECIFICATIONS

| | |
|----------------------|-----------------------|
| Charger Voltage..... | 7.2 Volt - 24 Volt DC |
| Charger Input | 120 V, 60 Hz, AC only |
| Charge Rate | 1 hour |
| Cord Length | 6 ft. |

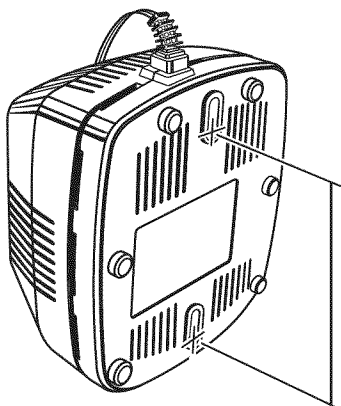
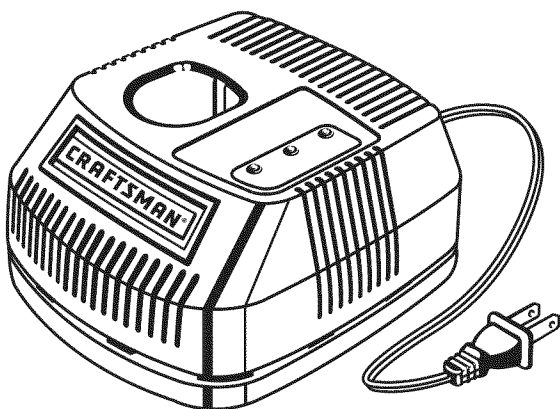

4-1/2 in.

KNOW YOUR CHARGER

See Figure 1.

Before attempting to use this product, familiarize yourself with all operating features and safety rules.

“KEY HOLE” HANGING

The charger has a “key hole” hanging feature for convenient, space-saving storage. Screws should be installed so the center distance is 4-1/2 in.

LED DISPLAY

The LED lights located next to each battery port indicate the charge status of each battery.

THERMAL PROTECTION

Your charger has a thermal protection system that prevents charging batteries that are too hot, which could

CAUTION

Do not use any DC to AC power inverters. Charger will be **Damaged!**

Fig. 1

OPERATION

APPLICATIONS

You may use this tool for the following purposes:

- Portable charging of Craftsman EX and DieHard 7.2 Volt - 24 Volt batteries

CAUTION: If at any point during the charging process none of the LEDs are lit, remove the battery pack from the charger to avoid damaging the product. DO NOT insert another battery. Return the charger and battery to your nearest service center for service or replacement.

LED FUNCTIONS OF CHARGER

LED WILL BE ON TO INDICATE STATUS OF CHARGER AND BATTERY PACK:

- Red LED on = Fast charging mode.
- Green LED on = Fully charged and in maintenance charge mode.
- Green LED on = When battery pack is inserted into charger, indicates hot battery pack or that battery pack is out of normal temperature range.
- Yellow and Green LEDs on = Deeply discharged or defective battery pack.
- No LED on = Defective charger or battery pack.

CHARGING A COOL BATTERY PACK

If battery pack is below normal temperature range, the green LED on charger will come on. Allow battery pack to reach normal temperature, then the red LED will come on.

NOTE: If the charger does not charge the battery pack under normal circumstances, return both the battery pack and charger to your nearest Sears Repair Center for electrical check.

- Charge the battery pack only with the charger provided.
- Make sure the power supply is normal household voltage, **120 V, 60 Hz, AC only.**
- Connect the charger to the power supply.
- Place the battery pack in the charger aligning raised rib on the battery pack with the groove in the charger. See *Figure 2*.
- Press down on the battery pack to be sure contacts on the battery pack engage properly with contacts in the charger.
- Normally the red LED on charger will come on. This indicates the charger is in fast charging mode.
- Red LED should remain on for approximately 1 hour then the green LED will come on. Green LED on indicates battery pack is fully charged and charger is in maintenance charge mode.

NOTE: The green LED will remain on until the battery pack is removed from the charger or charger is disconnected from the power supply.

- If both yellow and green LEDs come on, this indicates a deeply discharged or defective battery pack. Allow the battery pack to remain in the charger for 15 to 30 minutes. When the battery pack reaches normal voltage range, the red LED should come on. If the red LED does not come on after 30 minutes, this may indicate a defective battery pack and should be replaced.
 - After normal usage, a minimum of 1 hour of charging time is required to fully recharge battery pack.
 - The battery pack will become slightly warm to the touch while charging. This is normal and does not indicate a problem.
 - Do not place the charger and battery pack in an area of extreme heat or cold. They will work best at normal room temperature.
- NOTE:** The charger and battery pack should be placed in a location where the temperature is more than 50°F but less than 100°F.
- When batteries become fully charged, unplug the charger from power supply and remove the battery pack.

BATTERY SHOWN CHARGING (BATTERY SOLD SEPARATELY)

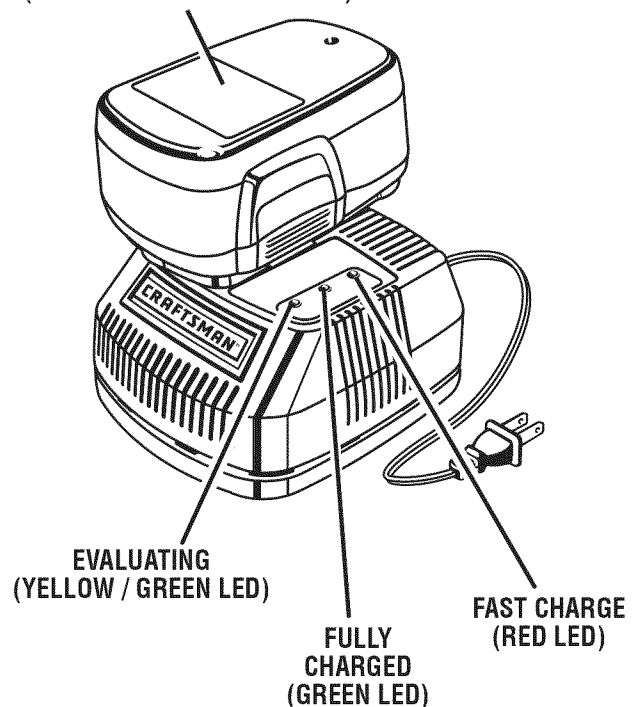

Fig. 2

OPERATION

CHARGING A HOT BATTERY PACK

When using the tool continuously, the batteries in the battery pack will become hot. You should let a hot battery pack cool down for approximately 30 minutes before attempting to recharge. When the battery pack becomes discharged and is hot, this will cause the green LED to come on instead of the red LED. After 30 minutes, reinsert the battery pack in the charger. If the green LED continues to remain on, return battery pack to your nearest Sears Repair Center for checking or replacing.

NOTE: This situation only occurs when continuous use of the tool causes the batteries to become hot. It does not occur under normal circumstances. Refer to “Charging a Cool Battery Pack” for normal recharging of batteries. If the charger does not charge your battery pack under normal circumstances, return both the battery pack and charger to your nearest Sears Repair Center for electrical check.

USE 11041 BATTERY CHARGER ONLY WITH BATTERY PACKS LISTED BELOW.

| TYPE 1 BATTERY PACK MODEL NUMBERS (require 1 hour to charge) |
|---|
|---|

| |
|--|
| 1310715, 1322521, 1322522, 1323408, 1323409, 1323501, 1323502, 1323505, 1323506, 1323513, 1323514, 1323516, 1323517, 1323903, 1323905, 1325101, 130235029, 130238003, 130238005, 130251008, 130279001, 130279002, 130279003, 130279004, 130279005, 130287001 |
|--|

| CHARGER CAN ALSO BE USED FOR PRODUCTS WITH THE FOLLOWING ITEM NUMBERS |
|--|
|--|

| |
|--|
| 10153, 11044, 11045, 11068, 11375, 11403, 11426, 11427, 11428, 11430, 11442, 11448, 11453, 11462, 11485, 11512, 11516, 11538, 11539, 11540, 11541, 11542, 11543, 11544, 11545, 11546, 11574, 11575 |
|--|

Get it fixed, at your home or ours!

Your Home

For repair – **in your home** – of **all** major brand appliances, lawn and garden equipment, or heating and cooling systems, **no matter who made it, no matter who sold it!**

For the replacement parts, accessories and owner's manuals that you need to do-it-yourself.

For Sears professional installation of home appliances and items like garage door openers and water heaters.

1-800-4-MY-HOME® (1-800-469-4663)

Call anytime, day or night (U.S.A. and Canada)

www.sears.com www.sears.ca

Our Home

For repair of carry-in items like vacuums, lawn equipment, and electronics, call or go on-line for the location of your nearest **Sears Parts & Repair Center.**

1-800-488-1222

Call anytime, day or night (U.S.A. only)

www.sears.com

To purchase a protection agreement (U.S.A.) or maintenance agreement (Canada) on a product serviced by Sears:

1-800-827-6655 (U.S.A.)

1-800-361-6665 (Canada)

Para pedir servicio de reparación a domicilio, y para ordenar piezas:

1-888-SU-HOGARSM

(1-888-784-6427)

Au Canada pour service en français:

1-800-LE-FOYER^{MC}

(1-800-533-6937)

www.sears.ca

