

Owner's Manual
for the
BXH-220
BASS AMPLIFIER



CRATE

musician made in the U.S.A.

CRATE BXH-220 BASS AMPLIFIER

Congratulations!

You are now the proud owner of the innovative Crate BXH-220 Bass amplifier. This feature-packed powerhouse offers you solid state reliability with classic Crate performance and high cosmetic appeal.





Like all Crate products, your BXH-220 Bass amp is Musician Made in the U.S.A., using only the best components. Extensive testing at many stages in its production, including a final "audition" by a skilled musician, insures you that your BXH-220 Bass amp is the best it can be.

In order to get the best possible performance, please read this manual before you use the amplifier.

And thank you for choosing **CRATE**.

Contents:

Introduction	3
Features	3
The Front Panel	4
The Rear Panel	5
Some Suggested Settings	6
System Block Diagram	7
Technical Specifications	back cover

 CAUTION RISK OF ELECTRIC SHOCK DO NOT OPEN	 ATTENTION RISQUE D'ELECTROCUTION NE PAS OUVRIR	 VORSICHT ELEKTRISCHE SCHLAGEFAHR NICHT OFFENEN
CAUTION: TO REDUCE THE RISK OF ELECTRIC SHOCK, DO NOT REMOVE COVER. NO USER-SERVICEABLE PARTS INSIDE. REFER SERVICING TO QUALIFIED SERVICE PERSONNEL.	ATTENTION: POUR REDUIRE D'ELECTROCUTION NE PAS ENLEVER LE COUVERCLE. AUCUNE PIECE INTERNE N'EST REPRABLE PAR L'UTILISATEUR. POUR TOUTE REPARATION, S'ADRESSER A UN TECHNICIEN QUALIFIE.	VORSICHT: ZUR MINIMIERUNG ELEKTRISCHER SCHLAGEFAHR NICHT DEN DECKEL ABENHMEN. INTERNE TEILE KÖNNEN NICHT VOM BENUTZER GEWARTET WERDEN. DIE WARTUNG IS QUALIFIZIERTEM WARTUNGSPERSONAL ZU ÜBERLASSEN.
THIS EQUIPMENT HAS BEEN DESIGNED AND ENGINEERED TO PROVIDE SAFE AND RELIABLE OPERATION. IN ORDER TO PROLONG THE LIFE OF THE UNIT AND PREVENT ACCIDENTAL DAMAGES OR INJURY, PLEASE FOLLOW THESE PRECAUTIONARY GUIDELINES:		
CAUTION: TO REDUCE THE RISK OF ELECTRIC SHOCK, DO NOT OPEN CHASSIS; DO NOT DEFEAT OR REMOVE THE GROUND PIN OF THE POWER CORD; CONNECT ONLY TO A PROPERLY GROUNDED AC POWER OUTLET.		
WARNING: TO REDUCE THE RISK OF FIRE OR ELECTRIC SHOCK, DO NOT EXPOSE THIS EQUIPMENT TO RAIN OR MOISTURE.		
CAUTION: NO USER-SERVICEABLE PARTS INSIDE. REFER SERVICING TO QUALIFIED SERVICE PERSONNEL.		
CAUTION: IF YOU USE AUDIO AMPLIFIERS PROFESSIONALLY OR IN WORK RELATED SITUATIONS AS AN EMPLOYEE, THE OCCUPATIONAL SAFETY AND HEALTH ADMINISTRATION (OSHA) HAS SPECIFIED REGULATIONS CONCERNING PROLONGED EXPOSURE TO HIGH SOUND PRESSURE LEVELS. PLEASE REFER TO THE CODE OF FEDERAL REGULATIONS DOCUMENT 29CFR1910 FOR ADDITIONAL INFORMATION.		
EXPLANATION OF GRAPHICAL SYMBOLS:	 = "DANGEROUS VOLTAGE" "DANGER HAUTE TENSION" "GEFAHLICHE SPANNUNG"	 = "IT IS NECESSARY FOR THE USER TO REFER TO THE INSTRUCTION MANUAL" "REFERREZ-VOUS AU MANUAL D'UTILISATION" "UNBEDINGT IN DER BEDIENUNGSANLEITUNG NACHSCHLAGEN"

Introduction:

Crate's new BXH-220 Bass amplifier is a feature-packed, professional-strength powerhouse which can deliver incredible bass sounds. Rugged construction, reliable American craftsmanship and solid state electronics add up to create one very roadworthy, stage-ready piece of gear.

The BXH-220 packs solid performance into a compact head unit, contained in a rugged Tolex[®] covered cabinet. Its side-mounted handle and heavy-duty rubber feet on two sides (not just the bottom, but also on the end you set it down on in real life) increase its value to those musicians who are always "on the go." The amplifier will deliver 220 watts into 4 ohms, or 150 watts into 8 ohms. A listing of the features of the amp is given below.

Features:

Additional information can be found on the pages indicated.

- Solid state circuitry for reliable service and incredible tones.
- Crate's APM (Automatic Power Maximizer) limiter circuit for the most output without distortion.
- Variable input gain control with -15dB pad switch and 3 input icon LEDs for the best match between your bass and the amplifier (page 4).
- Switchable contour control (page 4).
- 8-band graphic equalizer for optimum tone control (page 4).
- Balanced line out with adjustable level control and "pre/post" switch (pages 4 and 5).
- Headphone jack with adjustable level control for private practice sessions (page 4).
- Effects loop for noiseless use of your favorite processors and effects (page 5).
- Musician made in the U.S.A.
- Crate's exclusive 5-year warranty (U.S. only - see your dealer in other areas for warranty information)

CRATE BXH-220 BASS AMPLIFIER

The Front Panel:

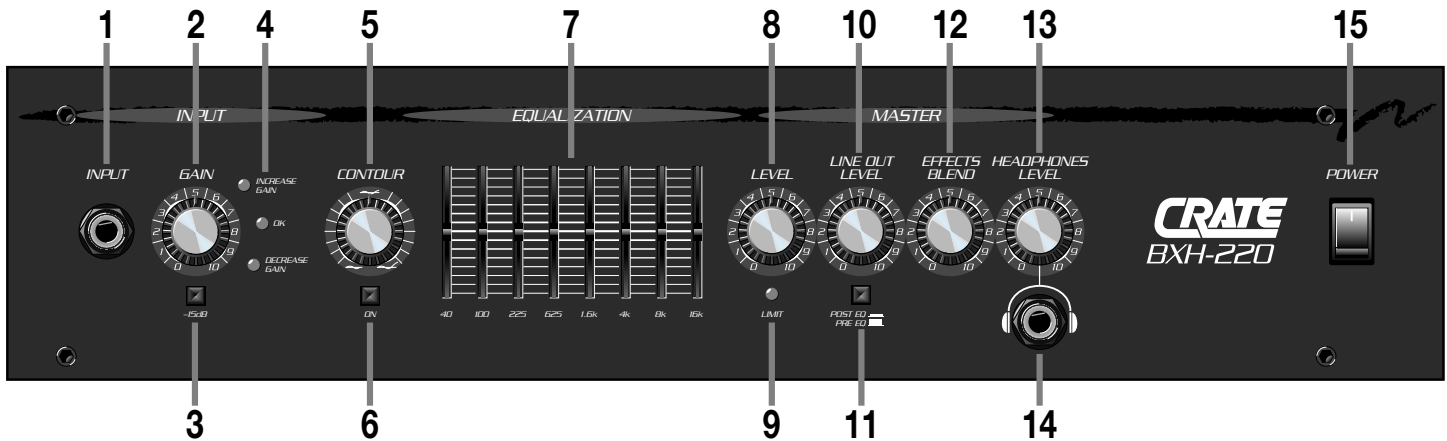

1. INPUT: Connect your bass to the amplifier here.

2. GAIN: Use this control to properly match the output of your bass to the amplifier. With the amp's Master level control at "0", begin playing your bass as you normally would. Watch the adjacent LEDs (#4) as you turn up the Gain control: the proper setting for the Gain control is the one where the "OK" LED lights most often while playing. If the "Decrease Gain" LED stays lit even with the Gain control turned down low, press in the -15dB button (#3) and continue adjusting the Gain control until the proper setting is obtained.

3. -15dB: If your bass has active electronics or "hot" pickups, its output signal may need to be padded to get the best signal to noise setting from the Gain control. If the "Decrease Gain" LED stays lit with the Gain control turned down low, press in the -15dB button.

4. LEDs: These three LEDs are your guide to properly setting the Gain control. Follow the steps given for the Gain control (#2) until the "OK" LED lights most often while you play.

5. CONTOUR: This control allows you to make additional changes to your tone and is active only when the Contour On/Off switch (#6) is pressed in. As the "wave" icons indicate you can enhance both the lows and highs at the same time, or add mid punch.

6. CONTOUR ON/OFF: Use this switch to engage the contour circuitry. With the switch pressed in, the Contour control (#5) is active.

7. EQUALIZATION: This eight-band graphic equalizer allows you to custom tailor your tone. Each slider controls the frequency indicated directly below it and offers a cut or boost of 10dB at various frequencies from 40Hz to 16kHz

8. MASTER LEVEL: Use this control to set the output level of the amplifier. This controls the signal level at the Speaker Output jacks (#19), as well as the Preamp Out jack (#17).

9. LIMIT: The amplifier employs Crate's APM Automatic Power Maximizer protection circuitry to keep the output distortion-free even at high volume levels. Whenever the output nears its clipping point, the limit circuit kicks in to keep the output clean. The Limit LED lights up when the APM limiter circuit is activated. Occasional flashing of the LED is normal. Very frequent flashing or constant illumination indicates the output level is too high; reduce the Master level control and/or your instrument's output until the LED flashes less.

10. LINE OUT LEVEL: This controls the level of the signal at the Balanced Line Out jack (#20). You may also use this output (or the headphone jack, #14) to run a signal to a tuner.

11. POST/PRE : This switch selects the tap point for the signal at the Balanced Line Out jack. With the switch pressed in, the signal is tapped *before* the eq, contour and effects loop ("pre"). With the switch pressed in, the signal is tapped *after* the eq, contour and effects loop ("post").

12. EFFECTS BLEND: This control proportions the amount of effect added to the signal going to the power amp stage. At the "0" position the signal is "dry" (no effect added); as you bring the control towards "10" the amount of effect applied increases. ("5" is a 50/50 blend of dry signal and effects.)

13. HEADPHONES LEVEL: This control adjusts the signal level at the Headphones jack (#14).

14. HEADPHONES: Plug a pair of stereo headphones in here for private listening. The signal at this jack is post Gain and post EQ. The level of the signal here is determined by the setting of the Headphones Level control (#13). **Using headphones does not disable the speaker outputs.** You may also use this output (or the line out jack, #20) to run a signal to a tuner.

15. POWER: This two-position switch turns the amp on and off, "on" being the UP position. The switch lights up when the amp is turned on.

CRATE BXH-220 BASS AMPLIFIER

The Rear Panel:

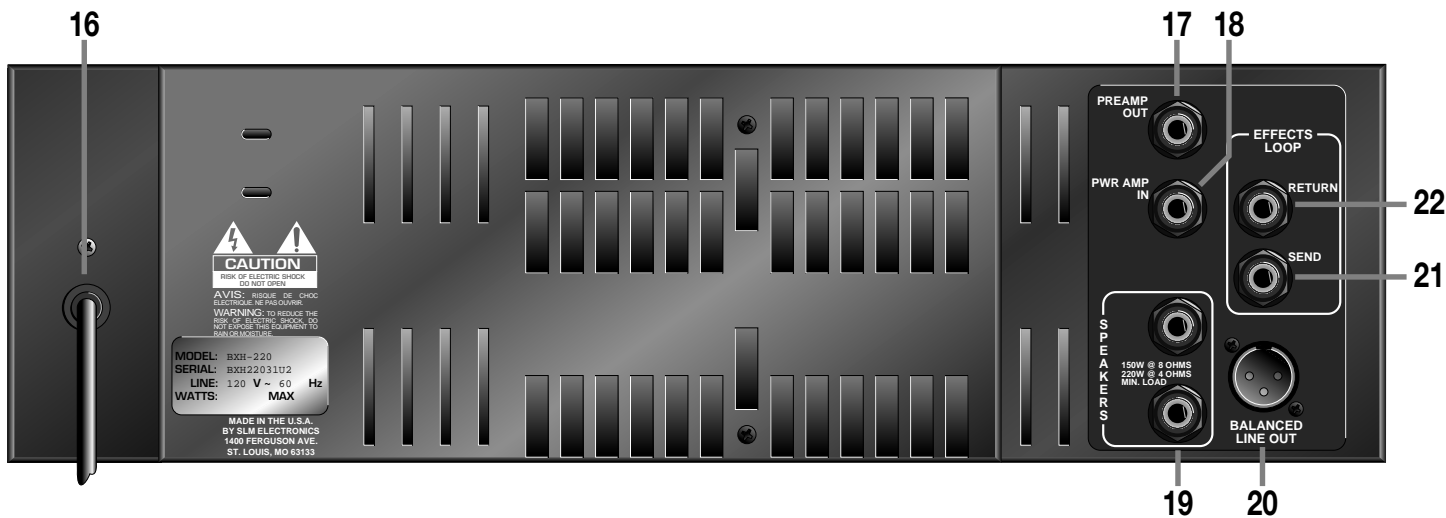

16. POWER CORD: Connect the male end of this cord to a properly grounded AC power outlet. **Use only a grounded outlet! DO NOT defeat the ground pin of the cord!** If the amplifier is used outside of the United States, see the area's Crate dealer for the proper power cord or consult a local professional electrician.

17. PREAMP OUT: A pre-amplified line-level signal may be tapped from this jack for sending to an external amplifier, powered monitor, recording console, mixing board or effects processor. This is an unbalanced, mono 1/4" jack.

18. POWER AMP IN: A pre-amplified line level signal may be sent directly into the bass amp's power amp (as when slaving two amplifiers together, for example). Connection to this jack interrupts the signal from the internal preamp to the power amp. The Preamp Out (#17) signal is **not** interrupted.

19. SPEAKERS: Use these jacks to connect the amp to your speaker cabinet(s). Use heavy-duty speaker cables with mono 1/4" plugs. These jacks are wired in parallel. Don't use cabinet combinations resulting in impedance loads below 4 ohms. Use the chart below to help determine parallel loads. If in doubt, ask your dealer.

<u>Cab Imp.</u>	<u># Cabs</u>	<u>Total Imp.</u>
8 ohms	2	4 ohms
16 ohms	2	8 ohms
16 ohms	4	4 ohms

20. BALANCED LINE OUT: Use this 3-pin XLR jack to send a line level signal to the house sound board or mixing console. The level of the signal at this jack is determined by the setting of the Line Out Level control on the front panel (#10). This signal is switchable to be either pre or post EQ through the front panel Pre/Post switch(#11).

21. EFFECTS LOOP SEND: This unbalanced jack lets you send a signal out to an external effects processor or tuner. The signal at this jack is post-EQ, pre-Master. Connect this to the input jack of the processor or tuner.

22. EFFECTS LOOP RETURN: This jack receives the signal from the output jack of an external effects processor. Use shielded cables with mono 1/4" plugs for connecting the Effects Loop.

CRATE BXH-220 BASS AMPLIFIER

Some Suggested Settings:

Rock:

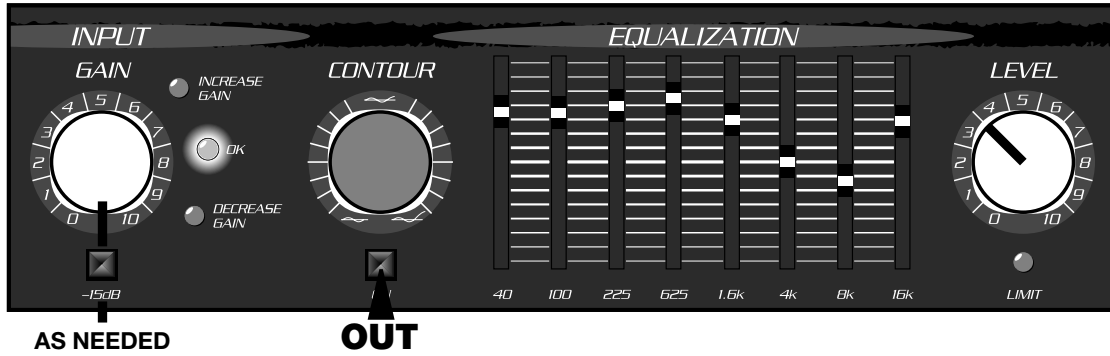

Jazz:

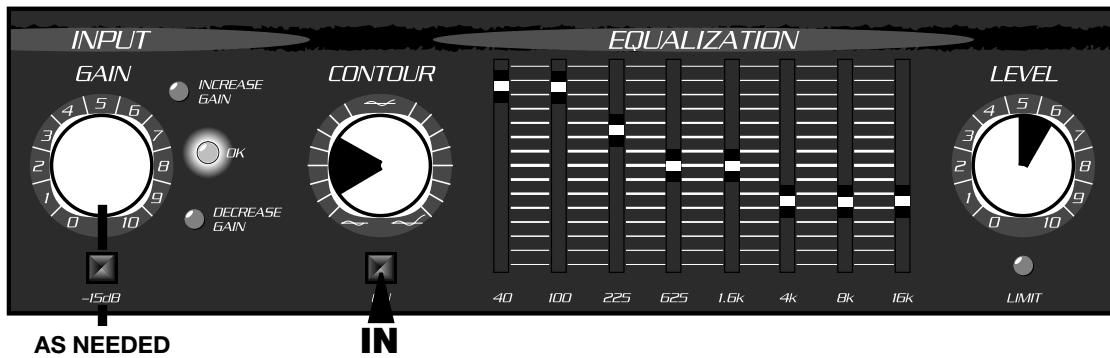

Country:

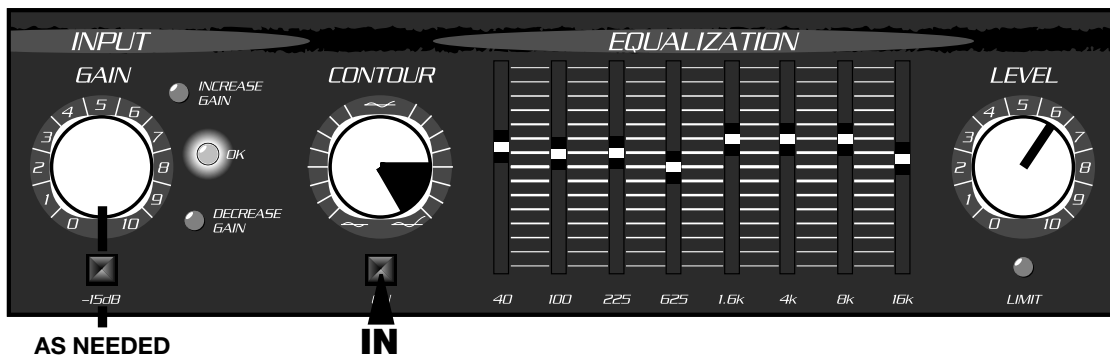

Funk:

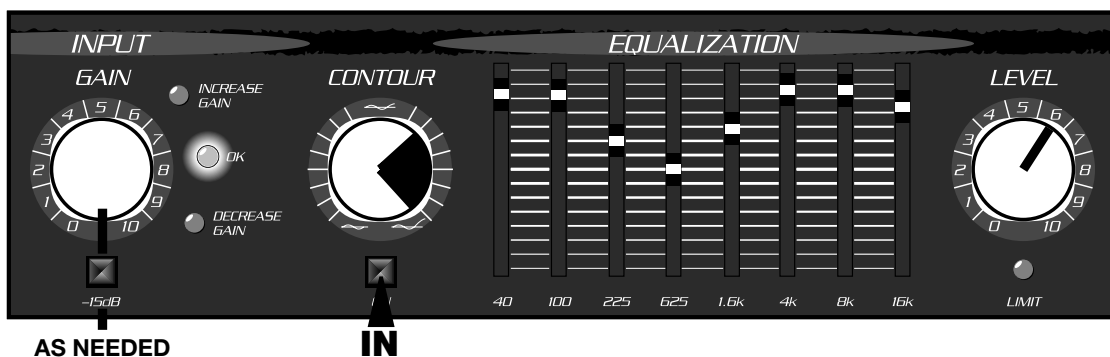

CRATE BXH-220 BASS AMPLIFIER

System Block Diagram:

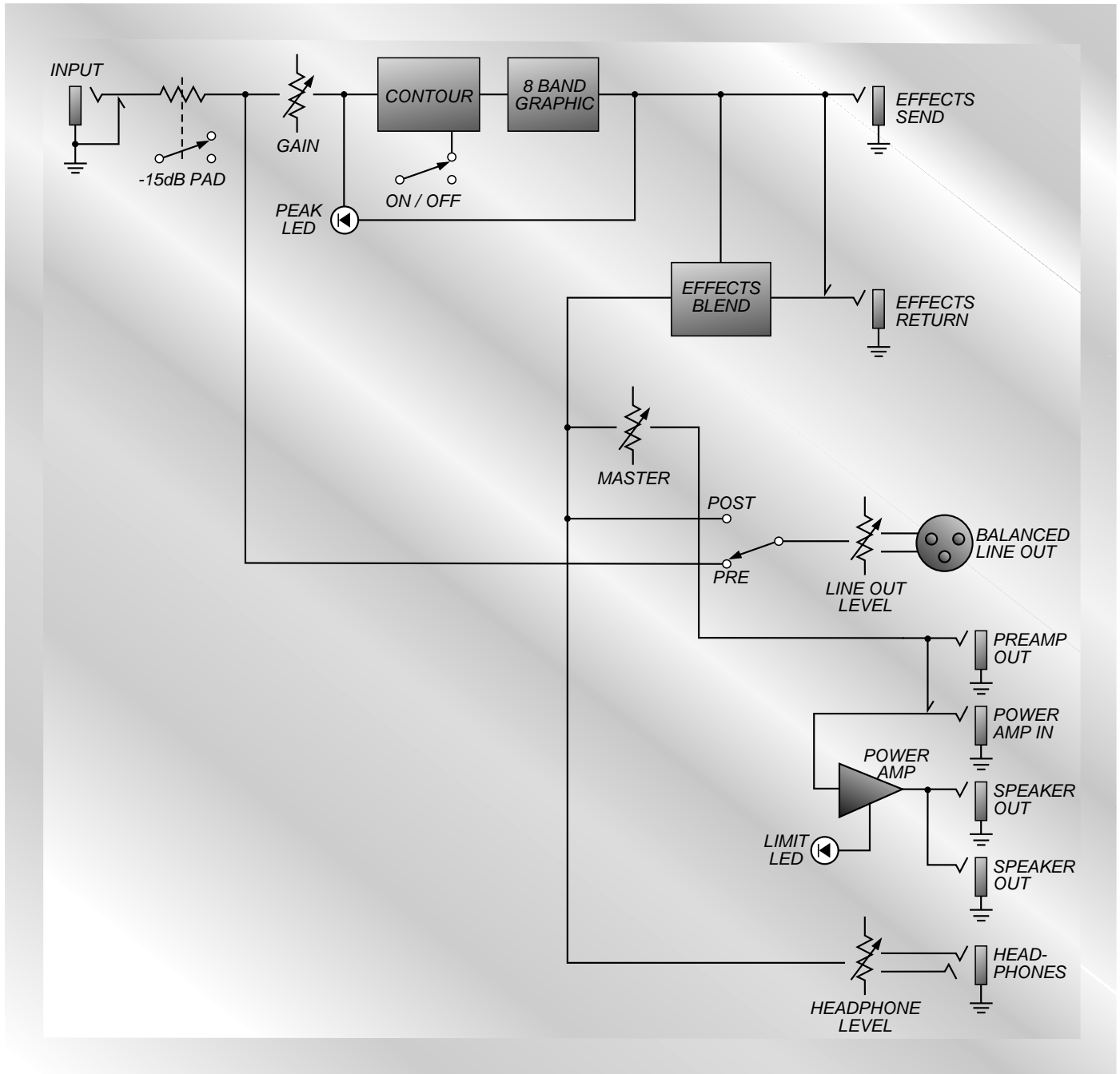

CRATE BXH-220 BASS AMPLIFIER

Technical Specifications:

Maximum Input Signal Level Accepted	17 volts peak to peak (-15dB switch pressed in)
Input Impedance	500k ohms (-15dB switch out), 75k ohms (-15dB switch in)
Signal to Noise Ratio	75dB typical
Output Power Rating	160 watts RMS @ < 5% THD w/8 ohm load, 120VAC line 220 watts RMS @ < 5% THD w/4 ohm load, 120VAC line
Gain @ 1kHz	67dB with EQ flat, Contour off
EQ Section	20dB range (± 10 dB) @ 40Hz, 100Hz, 225Hz, 625Hz, 1.6kHz, 4kHz, 8kHz and 16kHz
Input Power Requirements	120VAC, 60Hz, 250VA 100/120VAC, 50/60Hz, 250VA 230VAC, 50/60Hz, 250VA
Size and Weight	7-1/4"H x 21"W x 12-1/2"D, 35 lbs.

CRATE continually develops new products, as well as improves existing ones. For this reason, specifications and information in this manual are subject to change without notice.

CRATE

musician made in the U.S.A.

