

CRATE

GFX Amplifiers **WITH CHANNEL TRACKING** **& DIGITAL SIGNAL PROCESSING**

GFX-212T



GFX-120T

Owner's Manual

Congratulations!

You are now the proud owner of the Crate GFX-120T/212T amplifier. This rugged amplifier combines outstanding features with serious clean and distorted sounds. An easy to operate DSP section lets you dial in a variety of digital effects including reverbs, delays, octave and wah-wahs – with a separate level control. Crate's unique **Channel Tracking** feature means that as you switch between channels and gains, the DSP automatically “tracks” the changes - your DSP settings for each channel are stored and automatically recalled! The supplied three-button footswitch allows you to select channels, change the overdrive gain, and turn the DSP on and off by “remote control.” The top-mounted electronic tuner lets you get tuned and stay in tune any time the amplifier is on.

Like all Crate products, your GFX-120T/212T is designed by musicians, and built using only the best components. Extensive testing confirms that this amplifier is the absolute best it can be.

In order to get the most out of your new amplifier, we strongly urge you to read the information contained in this manual before you begin playing.







And **thank you** for choosing 

TABLE OF CONTENTS:	
The Digital Signal Processor	3
Channel Tracking	3
The Front Panel	4, 5
Suggested Settings	6
System Block Diagram	7
Technical Specificationsback cover

 CAUTION RISK OF ELECTRIC SHOCK DO NOT OPEN	 PRECAUCION RIESGO DE CORRIENTAZO NO ABRA	 ATTENTION RISQUE D'ELECTROCUTION NE PAS OUVRIR
WARNING: TO REDUCE THE RISK OF FIRE OR ELECTRIC SHOCK, DO NOT EXPOSE THIS APPARATUS TO RAIN OR MOISTURE. TO REDUCE THE RISK OF ELECTRIC SHOCK, DO NOT REMOVE COVER. NO USER-SERVICEABLE PARTS INSIDE. REFER SERVICING TO QUALIFIED SERVICE PERSONNEL.	PRECAUCION: PARA REDUIR EL RIESGO DE INCENDIOS O DESCARGAS ELECTRICAS, NO PERMITA QUE ESTE APARATO QUEDE EXPUESTO A LA LLUVIA O LA HUMEDAD. PARA DISMINUIR EL RIESGO DE CORRIENTAZO, NO ABRA LA CUBIERTA. NO HAY PIEZAS ADETRON QUE EL USUARIO PUEDO REPARAR DEJE TODO MANTENIMIENTO A LOS TECNICOS CALIFICADOS.	ATTENTION: PROTEGEZ CET APPAREIL DE LA PLUIE ET DE L'HUMIDITE AFIN D'EVITER TOUT RISQUE D'INCENDIE OU D'ELECTROCUTION. POUR REDUIRE D'ELECTROCUTION NE PAS ENLEVER LE COUVERCLE. AUCUNE PIECE INTERNE N'EST REPRABLE PAR L'UTILISATEUR. POUR TOUTE REPARATION, S'ADRESSER A UN TECHNICIEN QUALIFIE.
IMPORTANT SAFETY INSTRUCTIONS		
<ul style="list-style-type: none"> • READ, FOLLOW, HEED, AND KEEP ALL INSTRUCTIONS AND WARNINGS. • DO NOT OPERATE NEAR ANY HEAT SOURCE AND DO NOT BLOCK ANY VENTILATION OPENINGS ON THIS APPARATUS. FOR PROPER OPERATION, THIS UNIT REQUIRES 3" (75mm) OF WELL VENTILATED SPACE AROUND HEATSINKS AND OTHER AIR FLOW PROVISIONS IN THE CABINET. • DO NOT USE THIS APPARATUS NEAR SPLASHING, FALLING, SPRAYING, OR STANDING LIQUIDS. • CLEAN ONLY WITH LINT-FREE DAMP CLOTH AND DO NOT USE CLEANING AGENTS. • ONLY CONNECT POWER CORD TO A POLARIZED, SAFETY GROUNDED OUTLET WIRED TO CURRENT ELECTRICAL CODES AND COMPATIBLE WITH VOLTAGE, POWER, AND FREQUENCY REQUIREMENTS STATED ON THE REAR PANEL OF THE APPARATUS. • PROTECT THE POWER CORD FROM DAMAGE DUE TO BEING WALKED ON, PINCHED, OR STRAINED. • UNPLUG THE APPARATUS DURING LIGHTNING STORMS OR WHEN UNUSED FOR LONG PERIODS OF TIME. • ONLY USE ATTACHMENTS, ACCESSORIES, STANDS, OR BRACKETS SPECIFIED BY THE MANUFACTURER FOR SAFE OPERATION AND TO AVOID INJURY. • WARNING: TO REDUCE THE RISK OF ELECTRIC SHOCK OR FIRE, DO NOT EXPOSE THIS UNIT TO RAIN OR MOISTURE.. • SERVICE MUST BE PERFORMED BY QUALIFIED PERSONNEL. • OUR AMPLIFIERS ARE CAPABLE OF PRODUCING HIGH SOUND PRESSURE LEVELS. CONTINUED EXPOSURE TO HIGH SOUND PRESSURE LEVELS CAN CAUSE PERMANENT HEARING IMPAIRMENT OR LOSS. USER CAUTION IS ADVISED AND EAR PROTECTION IS RECOMMENDED IF UNIT IS OPERATED AT HIGH VOLUME. 		
EXPLANATION OF GRAPHICAL SYMBOLS: EXPLICACION DE SIMBOLOS GRAFICOS: EXPLICATION DES SYMBOLES GRAPHIQUES:	 = 	"DANGEROUS VOLTAGE" "VOLTAJE PELIGROSO" "DANGER HAUTE TENSION"
		"IT IS NECESSARY FOR THE USER TO REFER TO THE INSTRUCTION MANUAL" "ES NECESARIO QUE EL USUARIO SE REFIERA AL MANUAL DE INSTRUCCIONES." "REFERREZ-VOUS AU MANUAL D'UTILISATION"

The Digital Signal Processor:

Crate's Digital Signal Processing offers 16 exciting digital effects, accessible through the DSP Mode control. The effects are described below.

1	REV 1	small room reverb
2	REV 2	medium room reverb
3	REV 3	large room reverb
4	REV 4	concert hall reverb
5	DLY 1	short slapback + small room reverb
6	DLY 2	medium delay + plate reverb
7	DLY 3	long delay + large room reverb
8	FLNG 1	slow deep flange + reverb
9	FLNG 2	flange + reverb + delay
10	CHO 1	slow tremolo chorus + reverb
11	CHO 2	chorus + reverb + delay
12	RTRY	simulated rotating speaker effect
13	OCTV DN	adds a signal one octave lower than input
14	T-WAH	touch sensitive wah-wah effect
15	I-WAH	inverse wah-wah effect
16	DBLR	simulated second track, slightly out-of-sync

Use the DSP Mode control to access any of the 16 built-in digital effects. Use the level control to mix in the desired amount of each effect.



Channel Tracking:

Your Crate GFX-120T/212T gives you the power of **Channel Tracking!** Once you select a DSP setting for each channel, Channel Tracking recalls those DSP settings automatically – without changing the DSP controls! For example:

- Select the Clean channel. Set the DSP Mode to “FLNG 1” (*slow deep flange + reverb*)
- Select the Overdrive channel, Gain 1. Set the DSP Mode to “CHO 1” (*slow tremolo chorus + reverb*) (the setting for the Clean channel is now saved to memory)
- Select the Overdrive channel, Gain 2. Set the DSP Mode to “T-WAH000” (*touch sensitive wah-wah*) (the setting for the Overdrive channel, Gain 1 is now saved to memory)
- Reselect the Clean channel (the setting for the Overdrive channel, Gain 2 is now saved to memory)

Now when you go back to the Clean channel, even though the DSP Mode was last set to “T-WAH,” Channel Tracking automatically recalls the last setting for the Clean channel – in this example, “FLNG 1.” Change to the Overdrive channel, Gain 1, and “CHO 1” is recalled. Change to the Overdrive channel, Gain 2, and “T-WAH” is recalled. That’s the power of **Channel Tracking!**

(Note: Even when the power is turned off, **Channel Tracking** still retains the settings – until **you** change them!)

CRATE *GFX-120T/212T* Guitar Amps with DSP & Channel Tracking

The Front Panel:

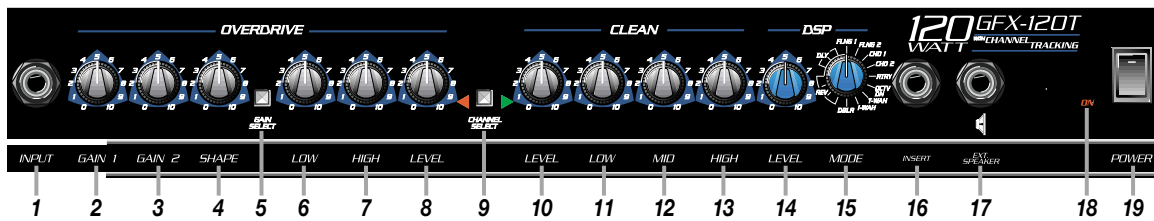

1: INPUT: Use this 1/4" jack to connect your guitar to the amplifier by means of a shielded instrument cable.

OVERDRIVE CHANNEL: A high gain channel giving you sounds from a slight edge to serious overdrive.

2: GAIN 1: Use this control to adjust the amount of light distortion for the Overdrive channel. Gain 1 produces less intense distortion than Gain 2 (#3) and is active when the Gain switch (#5) is in the out position.

3: GAIN 2: Use this control to adjust the amount of heavy distortion for the Overdrive channel. Gain 2 produces more intense distortion than Gain 1 (#2) and is active when the Gain switch (#5) is depressed.

4: SHAPE: Use this control to "dial in" the tone for the Overdrive channel when Gain 2 is selected. Rotating the control counterclockwise enhances the mid frequencies, while rotating the control clockwise enhances the low and high frequencies. This control is active only when Gain 2 is selected.

5: GAIN SELECT: Use this switch to select which gain control is active for the Overdrive channel. With the switch in the out position, Gain 1 is selected. When the switch is depressed, Gain 2 is selected.

6: LOW: Use this control to adjust the low frequency level of the Overdrive channel.

7: HIGH: Use this control to adjust the high frequency level of the Overdrive channel.

8: LEVEL: Use this control to adjust the output level of the Overdrive channel.

9: CHANNEL SWITCH: Use this switch to select either channel. With the switch in the out position, the Clean channel is selected. When the switch is depressed, the Overdrive channel is selected.

CLEAN CHANNEL: A normal gain channel designed to give you crystal clear sounds to medium distortion.

10: LEVEL: Use this control to adjust the output level of the Clean channel.

11: LOW: Use this control to adjust the low frequency level of the Clean channel.

12: MID: Use this control to adjust the midrange frequency level of the Clean channel.

13: HIGH: Use this control to adjust the high frequency level of the Clean channel.

14: DSP LEVEL: Use this control to adjust the amount of digital effect: in its fully counterclockwise position the signal will be "dry" (without any effect). As you rotate the control clockwise the amount of effect increases.

15: DSP MODE: Use this control to select one of the 16 built-in digital effects. The effects available are listed on page 3 of this manual.

16: INSERT: Use this jack to connect an external effects device to the amplifier. Use a stereo 1/4" male Y connector: ring = send, tip = return, sleeve = ground. (Refer to the illustration at the bottom of page 5.)

17: EXTERNAL SPEAKER: Use this jack to connect the amplifier to an external speaker. This jack is wired in series with the internal speaker, which remains active even when an external speaker is connected.

18: ON LED: This LED will illuminate when power is applied to the amplifier.

19: POWER: Use this switch to turn the amplifier on (top of the switch depressed) and off (bottom of the switch depressed).

The Electronic Tuner:

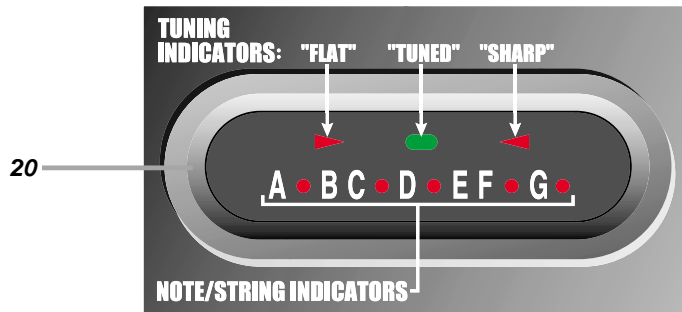

20. ELECTRONIC TUNER (top panel): The electronic tuner is active whenever the amplifier is turned on, providing constant, “real-time” tuning. The bottom row of LEDs indicate which note (string) is being tuned. The top row of LEDs provides directional queues to facilitate quick and precise tuning of your instrument. The indicated note (string) is properly tuned when only the center LED is illuminated.

The Rear Panel (not shown):

21: AC LINE CORD: This grounded power cord is to be plugged into a grounded power outlet, wired to current electrical codes and compatible with the voltage, power, and frequency requirements stated on the rear panel. **Do not attempt to defeat the safety ground connection.**

21: FUSE: The fuse protects the amplifier from damages caused by a faulty AC power source and/or other problems. If the fuse opens, replace it ONLY with the same size and type. If fuses continue to fail, check the AC source – if the source is okay, contact your Crate dealer for service information.

22: CHANNEL SELECT / GAIN FOOTSWITCH JACK: Use this jack to connect the stereo 1/4” plug of the supplied three-button footswitch for remote control of channel selection and gain selection.

23: REVERB FOOTSWITCH JACK: Use this jack to connect the mono 1/4” plug of the supplied three-button footswitch for remote control of DSP on and off.

CONNECTING TO THE INSERT JACK:

The Insert jack (#16) allows you to patch an external effects device into the amplifier prior to its power amp stage. Use Crate’s STP201, STP202 or STP203 stereo-to-mono Y cord or an adapter such as Crate’s YPP117 and two 1/4” mono signal cables to connect the effect as shown to the immediate right.

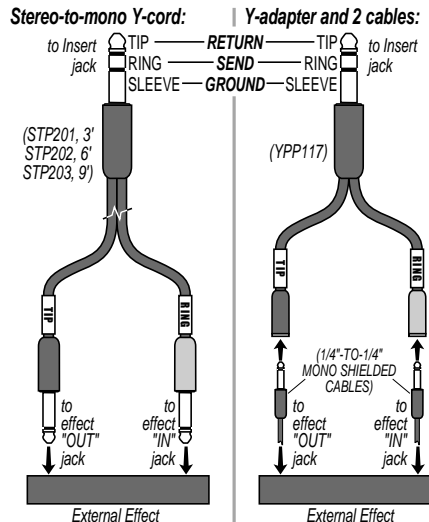

CRATE *GFX-120T/212T* Guitar Amps with DSP & Channel Tracking

Suggested Settings:

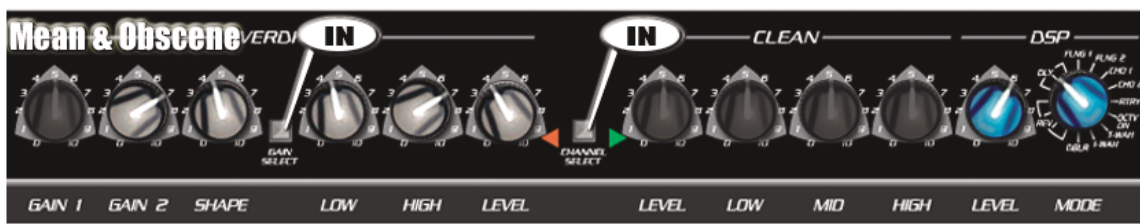
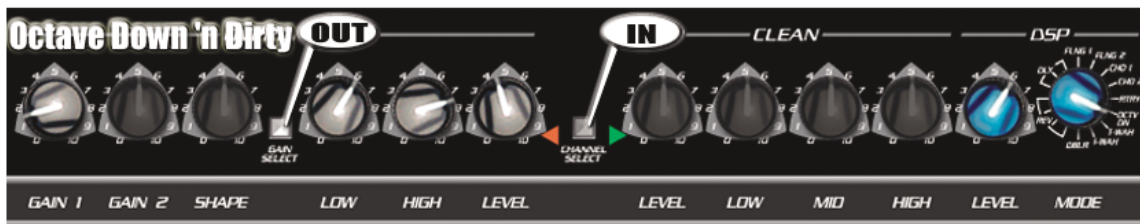

System Block Diagram:

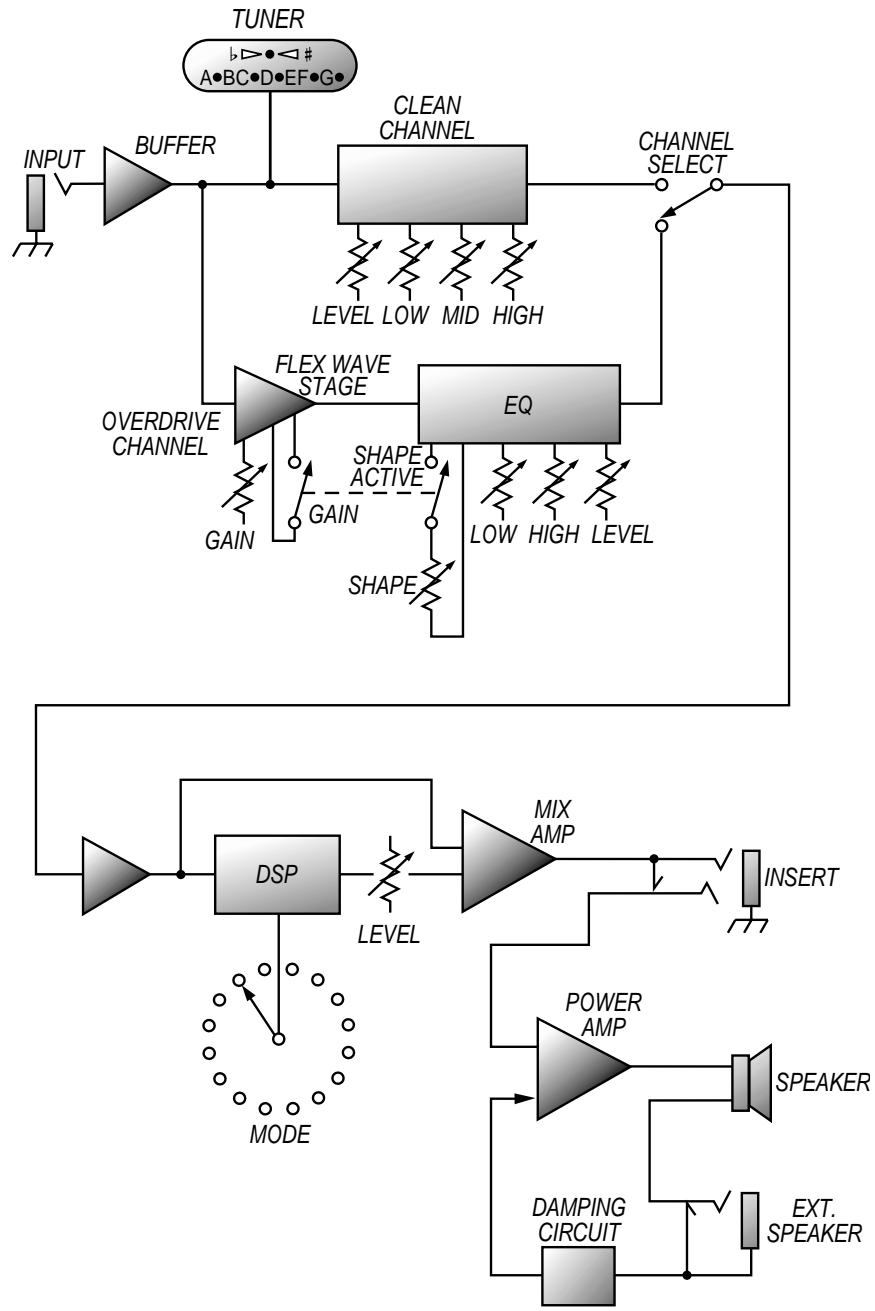

CRATE *GFX-120T/212T* Guitar Amps with DSP & Channel Tracking

GFX-120/212T TECHNICAL SPECIFICATIONS:

Output Power Rating		120W RMS @ 5% THD, 4Ω, 120 VAC
Speaker Size and Rating	GFX-120T	(1) Custom Design 12", 4Ω
	GFX-212T	(2) Custom Design 12", 8Ω
Input Impedance		470kΩ
Total System Gain	Overdrive Ch	Gain 1: 88dB, all controls @10; Gain 2: 110dB
	Clean Ch	58dB, all controls @10
Maximum Input Signal Accepted		7 volts peak-to-peak
Overdrive Channel	Low Control	11dB range @ 80Hz
	Shape Control	Proprietary Circuit
	High Control	10dB range @10kHz
Clean Channel	Low Control	22dB range @ 80Hz
	Mid Control	14dB range @ 600Hz
	High Control	28dB range @ 10kHz
Power Requirements		120 VAC, 60Hz, 95VA; 100/115VAC, 50/60Hz, 95VA; 100/115VAC, 50/60Hz, 95VA
Size and Weight	GFX-120T	17-1/2" H x 19-1/4" W x 9-3/4" D, 44 lbs.
	GFX-212T	21" H x 26-1/2" W x 11" D, 50 lbs.

The GFX-120T/212T is covered with a durable charcoal gray Tolex material: wipe it clean with a lint-free cloth. Never spray cleaning agents onto the cabinet. Avoid abrasive cleansers which would damage the finish.

Crate continually develops new products, as well as improves existing ones. For this reason, the specifications and information in this manual are subject to change without notice.

Declaration Of Conformity

#34, Effective 01-01-2001

Manufacturer's Name: SLM Electronics
Production Facility: 11880 Borman Drive, St. Louis, MO 63146, USA
Production Facility: 700 Hwy 202 W, Yellville, AR 72687, USA
Shipping Facility: 1400 Ferguson Ave., St. Louis, MO 63133, USA
Office Facility: 1400 Ferguson Ave., St. Louis, MO 63133, USA

Product Type: Audio Amplifier

Complies with Standards:
LVD: 92/31/EEC, 93/68/EEC, & 73/23/EWG
Safety: EN60065
EMC: EN55013, EN55020, EN55022, EN61000-3-2,
& EN61000-3-3

Supplementary information provided by your local Sales & Services Office or:
SLM Electronics - R & D Engineering
1901 Congressional Drive, St Louis, MO 63146, USA
Tel.: 314-569-0141, Fax: 314-569-0175



www.crateamps.com



©2001 SLM Electronics, a division of St. Louis Music, Inc • 1400 Ferguson Avenue • St. Louis, MO 63133
47-476-06 • 013003