

GT*X* Amplifiers
WITH CHANNEL TRACKING
& Digital Signal Processing



Owner's Manual

CRATE

Congratulations!

You are now the proud owner of the Crate GTX120/212 amplifier. This rugged amplifier combines outstanding features with serious clean and distorted sounds. An easy to operate DSP section lets you dial in a variety of digital effects including reverbs, delays, octave and wah-wahs – with a separate level control. Crate's unique **Channel Tracking** feature means that as you switch between channels and gains, the DSP automatically "tracks" the changes - your DSP settings for each channel are stored and automatically recalled! The supplied three-button footswitch allows you to select channels, change the overdrive gain, and turn the DSP on and off by "remote control."

Like all Crate products, your GTX120/212 is designed by musicians, and built using only the best components. Extensive testing confirms that this amplifier is the absolute best it can be.

In order to get the most out of your new amplifier, we strongly urge you to read the information contained in this manual before you begin playing.

And **thank you** for choosing **CRATE**.

TABLE OF CONTENTS:

The Digital Signal Processor3
Channel Tracking3
The Front Panel4, 5
Suggested Settings6
System Block Diagram7
Technical Specificationsback cover

	CAUTION RISK OF ELECTRIC SHOCK DO NOT OPEN	
<small>WARNING: TO REDUCE THE RISK OF FIRE OR ELECTRIC SHOCK, DO NOT EXPOSE THIS APPARATUS TO RAIN OR MOISTURE. TO REDUCE THE RISK OF ELECTRIC SHOCK, DO NOT REMOVE COVER. NO USER-SERVICEABLE PARTS INSIDE. REFER SERVICING TO QUALIFIED SERVICE PERSONNEL.</small>		

	PRECAUCION RIESGO DE CORRIENTAZO NO ABRA	
<small>ADVERTENCIA: REDUCIR EL RIESGO DE FUEGO O CHOQUE ELECTRICO. NO LE EXPONE DE ESTE APARATO A LLUVIA O HUMEDAD. PARA DISMINUIR EL RIESGO DE CORRIENTAZO. NO ABRA LA CUBIERTA. NO HAY PIEZAS ADENTRO QUE EL USUARIO PUEDO REPARAR DEJE TODO MANTENIMIENTO A LOS TECNICOS CALIFICADOS.</small>		

	ATTENTION RISQUE D'ELECTROCUTION NE PAS OUVRIR	
<small>ATTENTION: POUR REDUIRE D'ELECTROCUTION NE PAS ENLEVER LE COUVERCLE. AUCUNE PIECE INTERNE NEST REPRABLE PAR L'UTILISATEUR. POUR TOUTE REPARATION, S'ADRESSER A UN TECHNICIEN QUALIFIE.</small>		

IMPORTANT SAFETY INSTRUCTIONS

- READ, FOLLOW, HEED, AND KEEP ALL INSTRUCTIONS AND WARNINGS.
- DO NOT OPERATE NEAR ANY HEAT SOURCE AND DO NOT BLOCK ANY VENTILATION OPENINGS ON THIS APPARATUS.
- DO NOT USE THIS APPARATUS NEAR SPLASHING, FALLING, SPRAYING, OR STANDING LIQUIDS.
- CLEAN ONLY WITH LINT-FREE DAMP CLOTH AND DO NOT USE CLEANING AGENTS.
- ONLY CONNECT POWER CORD TO A POLARIZED, SAFETY GROUNDED OUTLET WIRED TO CURRENT ELECTRICAL CODES AND COMPATIBLE WITH VOLTAGE, POWER, AND FREQUENCY REQUIREMENTS STATED ON THE REAR PANEL OF THE APPARATUS.
- PROTECT THE POWER CORD FROM DAMAGE DUE TO BEING WALKED ON, PINCHED, OR STRAINED.
- UNPLUG THE APPARATUS DURING LIGHTNING STORMS OR WHEN UNUSED FOR LONG PERIODS OF TIME.
- ONLY USE ATTACHMENTS, ACCESSORIES, STANDS, OR BRACKETS SPECIFIED BY THE MANUFACTURER FOR SAFE OPERATION AND TO AVOID INJURY.
- THIS APPARATUS DOES NOT OPERATE NORMALLY AND REQUIRES SERVICE WITH ANY PHYSICAL DAMAGE FROM IMPACT OR ANY EXPOSURE TO MOISTURE.
- SERVICE MUST BE PERFORMED BY QUALIFIED PERSONNEL.
- OUR AMPLIFIERS ARE CAPABLE OF PRODUCING HIGH SOUND PRESSURE LEVELS. CONTINUED EXPOSURE TO HIGH SOUND PRESSURE LEVELS CAN CAUSE PERMANENT HEARING IMPAIRMENT OR LOSS. USER CAUTION IS ADVISED AND EAR PROTECTION IS RECOMMENDED IF UNIT IS OPERATED AT HIGH VOLUME.

EXPLANATION OF GRAPHICAL SYMBOLS:

EXPLICACION DE SIMBOLOS GRAFICOS:

EXPLICATION DES SYMBOLES GRAPHIQUES:



"DANGEROUS VOLTAGE"

"VOLTAJE PELIGROSO"

"DANGER HAUTE TENSION"



"IT IS NECESSARY FOR THE USER TO REFER TO THE INSTRUCTION MANUAL"

"ES NECESARIO QUE EL USUARIO SE REFERIA AL MANUAL DE INSTRUCCIONES."

"REFERREZ-VOUS AU MANUAL D'UTILISATION"

The Digital Signal Processor:

Crate's Digital Signal Processing offers 16 exciting digital effects, accessible through the DSP Mode control. The effects are described below.

1	small room reverb
2	medium room reverb
3	large room reverb
4	concert hall reverb
5	short slapback w/small room reverb
6	medium delay w/plate reverb
7	long delay w/large room reverb
8	slow deep flange w/reverb
9	flange w/reverb & delay
10	slow chorus w/reverb
11	chorus w/reverb & delay
12	rotating speaker
13	octave down
14	touch wah
15	inverse wah
16	doubler

Use the DSP Mode control to access any of the 16 built-in digital effects. Use the Level control to mix in the desired amount of each effect.



Channel Tracking:

Your Crate GTX120/212 gives you the power of **Channel Tracking!** Once you select a DSP setting for each channel, Channel Tracking recalls those DSP settings automatically – without changing the DSP controls! For example:

- Select the Clean channel. Set the DSP Mode to “8” (*slow deep flange w/reverb*)
- Select the Rhythm/Solo channel, Gain 1. Set the DSP Mode to “10” (*slow chorus w/reverb*) (the setting for the Clean channel is now saved to memory)
- Select the Rhythm/Solo channel, Gain 2. Set the DSP Mode to “14” (*touch wah*) (the setting for the Rhythm/Solo channel, Gain 1 is now saved to memory)
- Reselect the Clean channel (the setting for the Rhythm/Solo channel, Gain 2 is now saved to memory)

Now when you go back to the Clean channel, even though the DSP Mode was last set to “14” (touch wah), Channel Tracking automatically recalls the last setting for the Clean channel – in this example, “8” (slow flange). Change to the Rhythm/Solo channel, Gain 1, and “10” (chorus) is recalled. Change to the Rhythm/Solo channel, Gain 2, and “14” (touch wah) is recalled. That’s the power of **Channel Tracking!**

(Note: Even when the power is turned off, **Channel Tracking** still retains the settings – until **you** change them!)

The Front Panel:

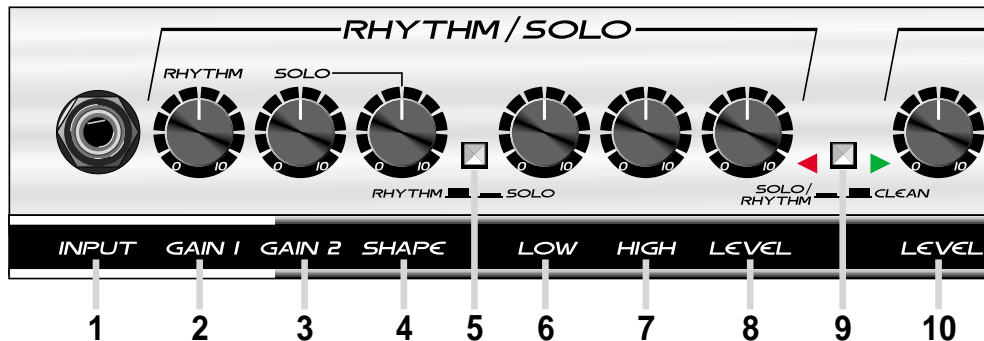

1: INPUT: Use this 1/4" jack to connect your guitar to the amplifier by means of a shielded instrument cable.

RHYTHM/SOLO CHANNEL: A high gain channel giving you sounds from a slight edge to serious overdrive.

2: RHYTHM GAIN 1: Use this control to adjust the amount of light distortion for the Rhythm/Solo channel. Gain 1 produces less intense distortion than Gain 2 (#3) and is active when the Rhythm/Solo Gain switch (#5) is in the out position.

3: SOLO GAIN 2: Use this control to adjust the amount of heavy distortion for the Rhythm/Solo channel. Gain 2 produces more intense distortion than Gain 1 (#2) and is active when the Rhythm/Solo Gain switch (#5) is depressed.

4: SHAPE: Use this control to "dial in" the tone for the Rhythm/Solo channel when Gain 2 is selected. Rotating the control counterclockwise enhances the mid frequencies, while rotating the control clockwise enhances the low and high frequencies.

5: RHYTHM/SOLO SWITCH: Use this switch to select which gain control is active for the Rhythm/Solo channel. With the switch in the out position, Gain 1 (Rhythm) is selected. When the switch is depressed, Gain 2 (Solo) is selected.

6: LOW: Use this control to adjust the low frequency level of the Rhythm/Solo channel.

7: HIGH: Use this control to adjust the high frequency level of the Rhythm/Solo channel.

8: LEVEL: Use this control to adjust the output level of the Rhythm/Solo channel.

9: CHANNEL SWITCH: Use this switch to select the desired channel. With the switch in the out position, the Clean channel is selected. When the switch is depressed, the Rhythm/Solo channel is selected.

CLEAN CHANNEL: A normal gain channel designed to give you sounds from crystal clear to medium distortion.

10: LEVEL: Use this control to adjust the output level of the Clean channel.

11: LOW: Use this control to adjust the low frequency level of the Clean channel.

12: MID: Use this control to adjust the midrange frequency level of the Clean channel.

13: HIGH: Use this control to adjust the high frequency level of the Clean channel.

14: DSP LEVEL: Use this control to adjust the amount of digital effect: in its fully counterclockwise position the signal will be "dry" (without any effect). As you rotate the control clockwise the amount of effect increases.

15: DSP MODE: Use this control to select one of the 16 built-in digital effects. The effects are shown on page 3.

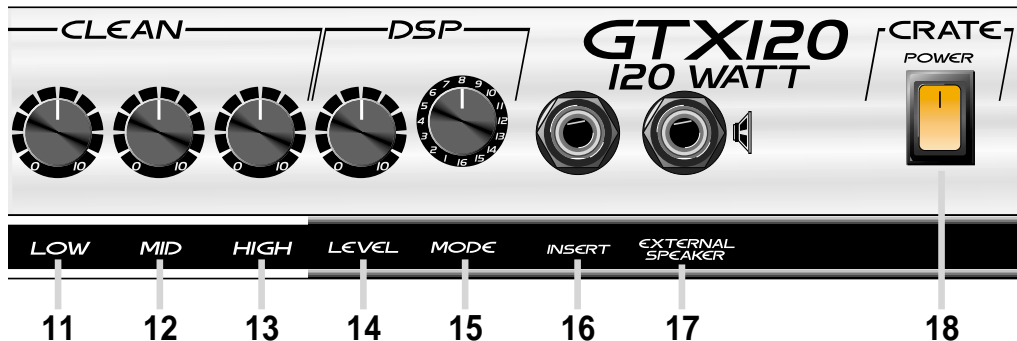

16: INSERT: Use this jack to connect an external effects device to the amplifier. Use a stereo 1/4" male Y connector: ring = send, tip = return, sleeve = ground. (Refer to the illustration at the bottom of page 5.)

17: EXTERNAL SPEAKER: Use this jack to connect an external speaker to the amplifier. This jack is wired in series with the internal speaker(s) which remain active when an external speaker is connected.

18: POWER: Use this switch to turn the amplifier on (top of the switch depressed) and off (bottom of the switch depressed). The switch is illuminated when the amplifier is on.

19: AC LINE CORD (rear panel, not shown): This grounded power cord is to be plugged into a grounded power outlet, wired to current electrical codes and compatible with the voltage, power, and frequency requirements stated on the rear panel. **Do not attempt to defeat the safety ground connection.**

20: FUSE (rear panel, not shown): The fuse protects the amplifier from damages caused by a faulty AC power source and/or other problems. If the fuse opens, replace it **ONLY** with the same size and type. If fuses continue to fail, check the AC source – if the source is okay, contact your Crate dealer for service information.

21: CHANNEL SELECT / GAIN FOOTSWITCH JACK (rear panel, not shown): Use this jack to connect the 1/4" stereo plug on the footswitch cable to the three-button footswitch (supplied). This allows you to remotely switch between the Clean and Rhythm/Solo channels and between Rhythm Gain 1 and Solo Gain 2 of the Rhythm/Solo channel.

22: REVERB FOOTSWITCH JACK (rear panel, not shown): Use this jack to connect the 1/4" mono plug on the footswitch cable to the three-button footswitch (supplied). This allows you to remotely turn the DSP function on and off.

CONNECTING TO THE INSERT JACK:

The Insert jack (#16) allows you to patch an external effects device into the amplifier prior to its power amp stage. Use Crate's STP201, STP202 or STP203 stereo-to-mono Y cord or an adapter such as Crate's YPP117 and two 1/4" mono signal cables to connect the effect as shown in the adjacent illustration.

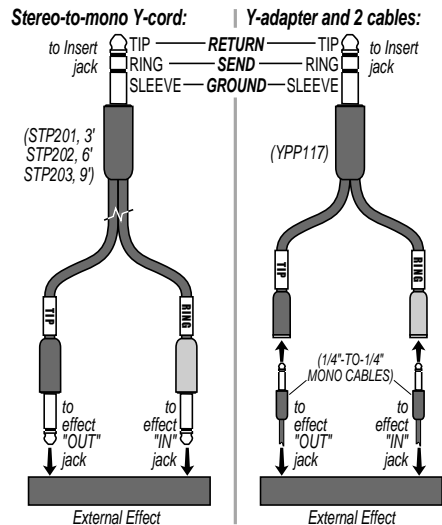

Suggested Settings:

"Sweet 'n Clean"



"Just a 'Lil Nasty"

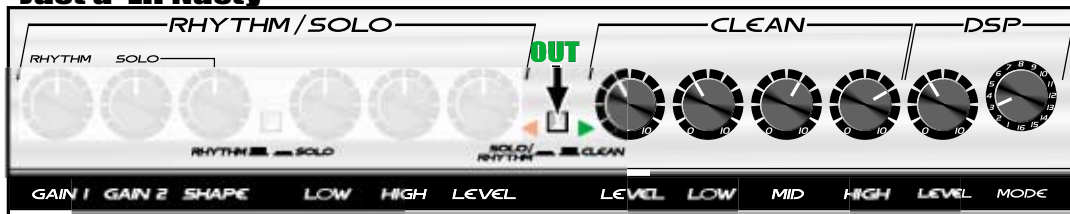

"Politely Gritty"

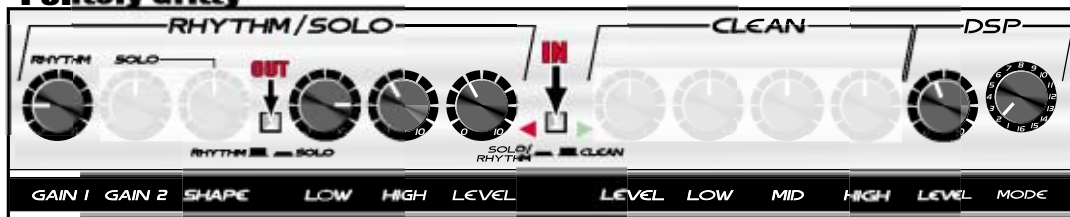

"Octave Down 'n Dirty"

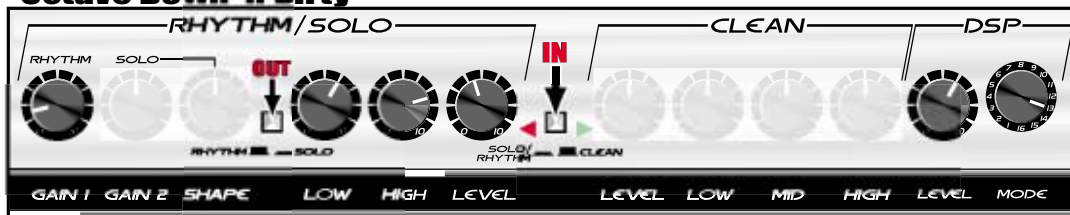

"Wah Full House"

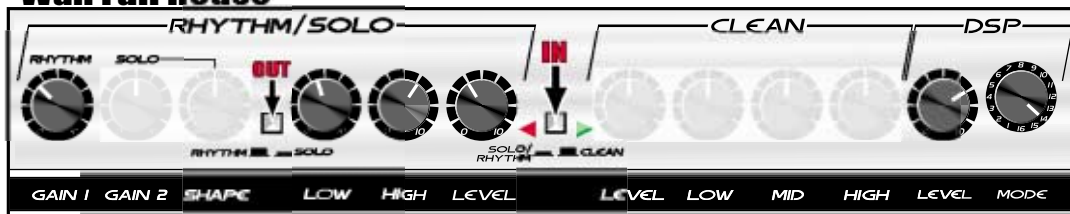

"Mean & Obscene"

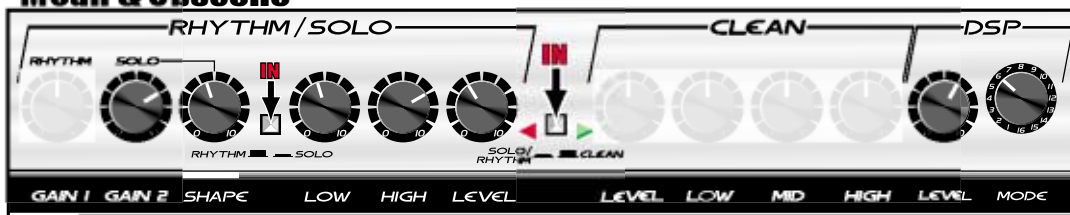

System Block Diagram:

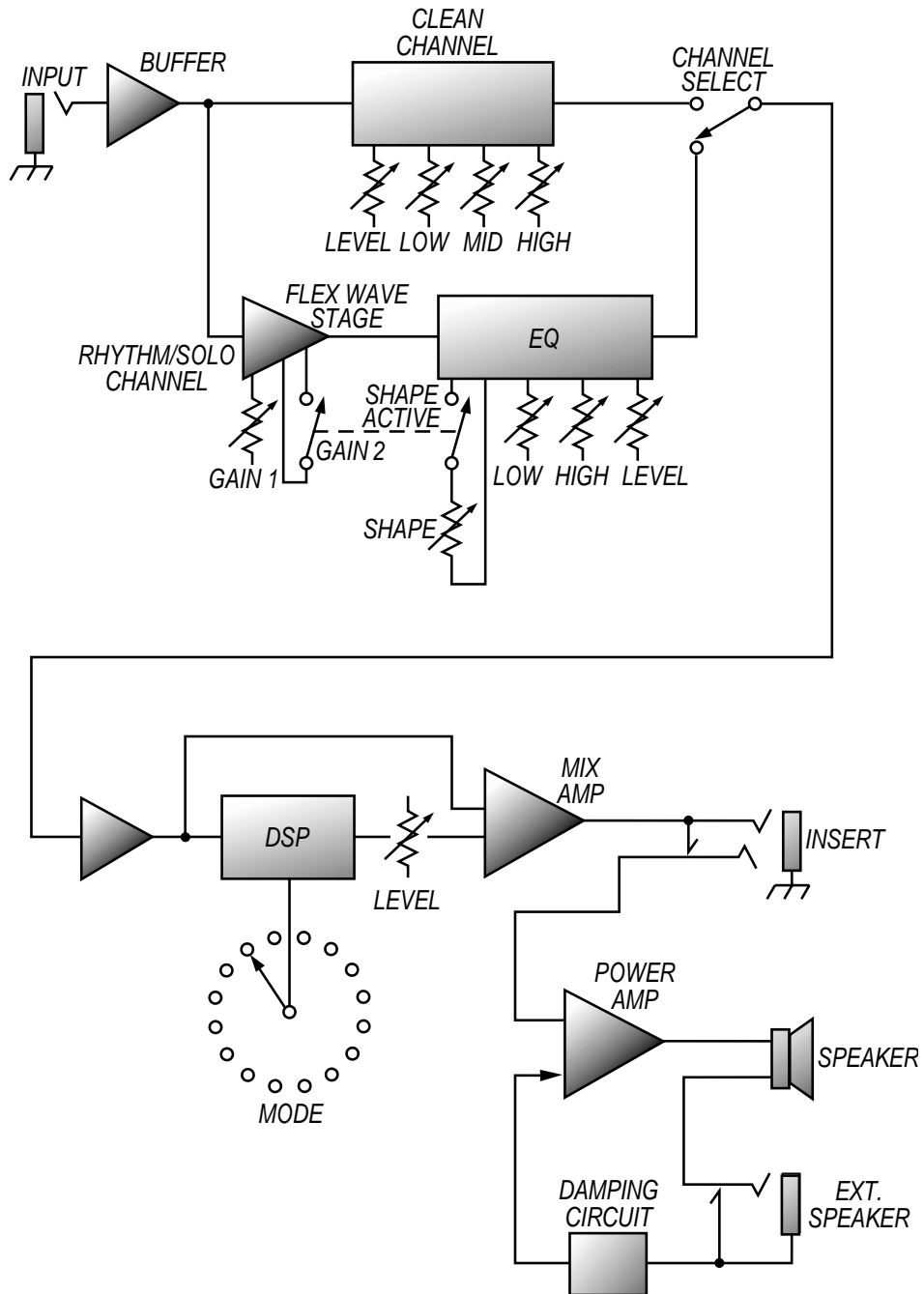



GTX120/212 Guitar Amplifier with DSP & Channel Tracking

GTX120/212 TECHNICAL SPECIFICATIONS:

Output Power Rating		120W RMS @ 5% THD, 4Ω, 120 VAC
Speaker Size and Rating	GTX120	(1) Custom Design 12", 4Ω
	GTX212	(2) Custom Design 12", 8Ω
Input Impedance		470kΩ
Total System Gain	Overdrive Ch	Gain 1: 88dB, all controls @10; Gain 2: 110dB
	Clean Ch	58dB, all controls @10
Maximum Input Signal Accepted		7 volts peak-to-peak
Rhythm/Solo Channel	Low Control	11dB range @ 80Hz
	Shape Control	Proprietary Circuit
	High Control	10dB range @10kHz
Clean Channel	Low Control	22dB range @ 80Hz
	Mid Control	14dB range @ 600Hz
	High Control	28dB range @ 10kHz
Power Requirements		120 VAC, 60Hz, 95VA; 100VAC, 50/60Hz, 95VA; 230VAC, 50Hz, 95VA
Size and Weight	GTX120	17-1/2" H x 20" W x 11" D, 34 lbs.
	GTX212	21" H x 26.5" W x 11" D, 50 lbs.

The GTX120/212 is covered with a durable charcoal gray Tolex material: wipe it clean with a lint-free cloth. Never spray cleaning agents onto the cabinet. Avoid abrasive cleansers which would damage the finish.

Crate continually develops new products, as well as improves existing ones. For this reason, the specifications and information in this manual are subject to change without notice.

Declaration Of Conformity

#34, Effective 01-01-2001

Manufacturer's Name: SLM Electronics
Production Facility: 11880 Borman Drive, St. Louis, MO 63146, USA
Production Facility: 700 Hwy 202 W, Yellville, AR 72687, USA
Shipping Facility: 1400 Ferguson Ave., St. Louis, MO 63133, USA
Office Facility: 1400 Ferguson Ave., St. Louis, MO 63133, USA

Product Type: Audio Amplifier

Complies with Standards:
LVD: 92/31/EEC, 93/68/EEC, & 73/23/EWG
Safety: EN60065
EMC: EN55013, EN55020, EN55022, EN61000-3-2, & EN61000-3-3

Supplementary information provided by:
 SLM Electronics - R & D Engineering
 1901 Congressional Drive, St Louis, MO 63146, USA
 Tel.: 314-569-0141, Fax: 314-569-0175



www.crateamps.com

