

CREATIVE

**Xdock** User's Guide

# Congratulations!

Your Creative Xdock™ harnesses Creative's X-Fi™ technology to give you audio beyond CD quality. With your iPod® docked in Xdock, music from your home theater system has never sounded better!

Read on to learn how to get started with your new Xdock!

## Contents

About Your Xdock .....	2
About Your Remote Control .....	3
Setting Up Your Xdock .....	4
Playing Music From Your iPod .....	7
Using Your Xdock .....	9
Using X-Fi Enhancements .....	14
Connecting Headphones .....	15
Connecting To An External Stereo Audio Source .....	15
Transferring Music From iTunes .....	16
FAQs .....	17
General Specifications .....	22
Safety Information .....	23
European Compliance .....	24

# About Your Xdock

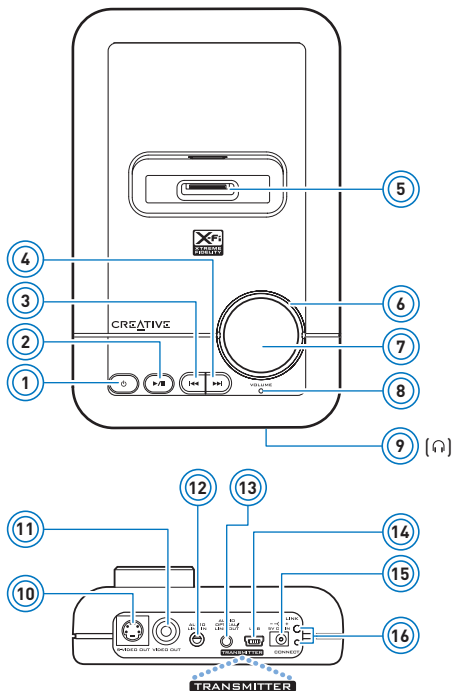

- 1 Power/Standby button
- 2 Play/Pause button
- 3 Previous/Rewind button
- 4 Next/Fast-forward button
- 5 iPod connector
- 6 Volume LED ring
- 7 Volume control  
See "Using Your Xdock" on page 9.
- 8 Power/Standby LED  
See "Understanding the Power/Standby LED" on page 10.
- 9 Headphone jack
- 10 S-Video Out jack
- 11 Video Out jack
- 12 Audio Line In jack
- 13 Audio Optical/ Line Out jack
- 14 USB port
- 15 5V DC In jack
- 16 Link LED and Connect button  
For use with X-Fi Wireless Receivers.

# About Your Remote Control

Your remote control has an operating distance of up to three meters (approximately 9.8 feet).

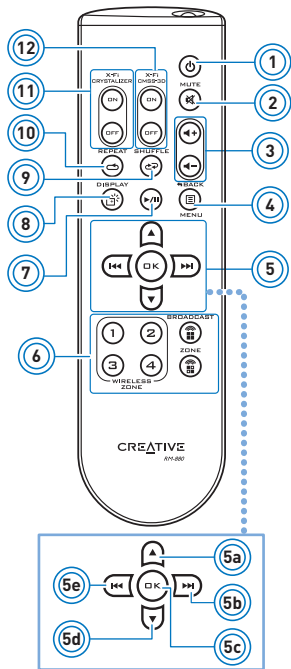

- 1 Power/Standby button
- 2 Mute on/off button
- 3 Volume buttons
- 4 iPod Back/Menu button
- 5 iPod Navigation keypad
  - 5a. Scrolls up.
  - 5b. Skips to the next track or fast-forwards a track.
  - 5c. Executes a selected option in a menu.
  - 5d. Scrolls down.
  - 5e. Skips to the previous track or rewinds a track.
- 6 Broadcasting and Zone control buttons  
For use with X-Fi Wireless Receivers. See "Enabling wireless features" on page 11.
- 7 Play/Pause button
- 8 iPod Backlight button  
The backlight in your iPod automatically turns off after 30 seconds.
- 9 iPod Shuffle option button
- 10 iPod Repeat option button
- 11 X-Fi Crystalizer™ on/off buttons
- 12 X-Fi CMSS®-3D on/off buttons

# Setting Up Your Xdock

## Step 1: Select a Dock adapter

Your Xdock comes with five different Dock adapters, each to fit a different iPod. Look at the number on the side of each Dock adapter to select the correct one for your iPod.



	<b>iPod mini</b> <b>(4 GB and 6 GB)</b>	<b>3</b>	
	<b>iPod</b> <b>(20 GB and U2 Special Edition)</b>	<b>4</b>	
	<b>iPod</b> <b>(40 GB)</b>	<b>5</b>	
	<b>iPod with color display</b> <b>(20 GB, 30 GB and U2 Special Edition)</b>	<b>6</b>	
	<b>iPod with color display</b> <b>(40 GB and 60 GB)</b>	<b>7</b>	

**NOTES** Other iPod models are supplied with their own Dock adapters.

## Step 2: Insert the Dock adapter

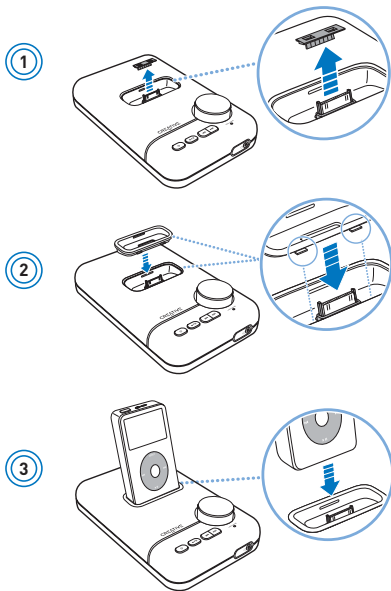

**IMPORTANT** Your iPod charges automatically when your Xdock is connected to the power outlet.

## Step 3: Connect Your Xdock

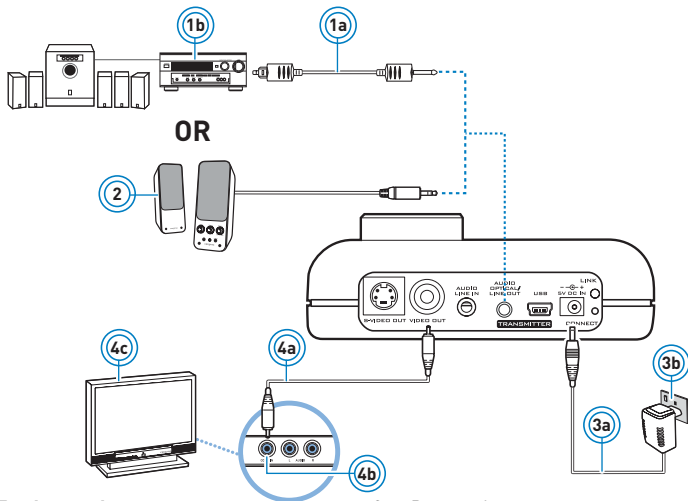

### For home theater

- 1a Optical cable
- 1b Home theater receiver  
(with an Optical In jack and DTS™ decoding support)

- 3a Power adapter

- 3b Power outlet

- 4a RCA cable

- 4b Video In jack - Yellow

- 4c TV (for iPod models with video)

### For powered stereo speakers

- 2 Powered stereo or 2.1 speakers

- NOTES**
- You can also connect Xdock to a home theater using a 3.5 mm audio cable, and to a TV using an S-Video cable.

## Turning on Xdock

When you connect Xdock to the power outlet, Xdock will prepare the wireless connection, so that when it is needed, the best connection can be made without any interference. During this time, the Power/Standby LED will flash red and finally light up blue.

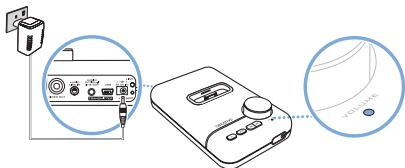

## Playing Music From Your iPod

### Step 1: Insert batteries into your remote control

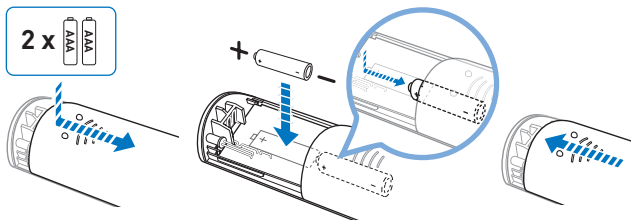

**IMPORTANT** The cover of your remote control can only be opened halfway. Do not try to detach the cover when inserting the batteries.



## Step 2: Play music

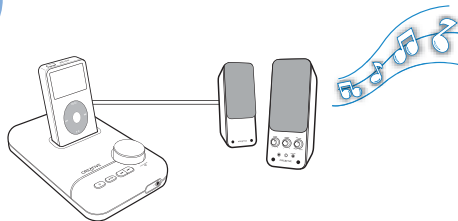
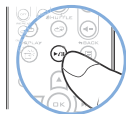

**IMPORTANT** To save your volume and the X-Fi enhancements' on/off settings, enable Standby mode by pressing the Power/Standby button  on the remote control. The Power/Standby LED lights up red. You may then unplug Xdock from the power outlet.

# Using Your Xdock

## Adjusting volume



When you adjust the volume, the Volume LED ring indicates for about four seconds the level selected. Subsequently, the entire Volume LED ring remains lit.

**NOTES** You can also use the Volume control on Xdock.

## Muting audio



When you mute audio, the Power/Standby LED flashes red. To unmute, press the Mute button again. The Power/Standby LED lights up blue.

**NOTES** You can also press the Volume control on Xdock.

## Turning on Xdock or enabling Standby mode

Press the Power/Standby button  on your remote control to turn on Xdock or enable Standby mode. For Power/Standby LED information, see “Understanding the Power/Standby LED” below.

**NOTES** You can also press the Power/Standby button  on Xdock.

## Returning to factory default settings

Press and hold the Previous/Rewind and Next/Fast-forward buttons on your Xdock together for three seconds. The Volume LED ring lights up. For more information, see “FAQs” on page 17.

## Understanding the Power/Standby LED

LED	Behavior	Status
Blue	Stable	Turned on and ready for use.
Red	Stable	In Standby mode.
	Flashing	Muted.

**NOTES** For information on the Link LED, see the Creative X-Fi Wireless Receiver User's Guide.

## Enabling wireless features

To stream music wirelessly throughout the house, purchase the Creative X-Fi Wireless Receiver.

- Broadcast music to every room in the house.

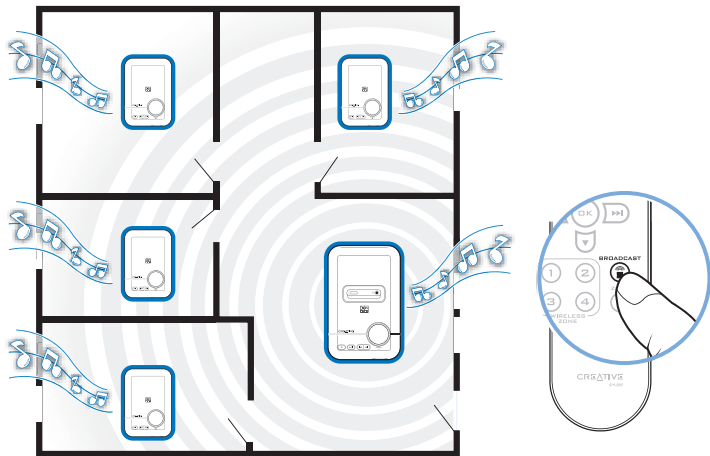

- Control which rooms (up to four) receive music.

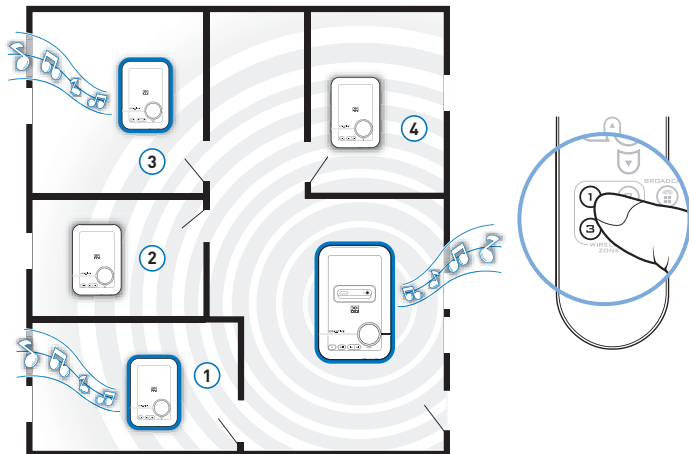

- Remotely stream music to your X-Fi Wireless Receivers, while your Xdock remains muted.

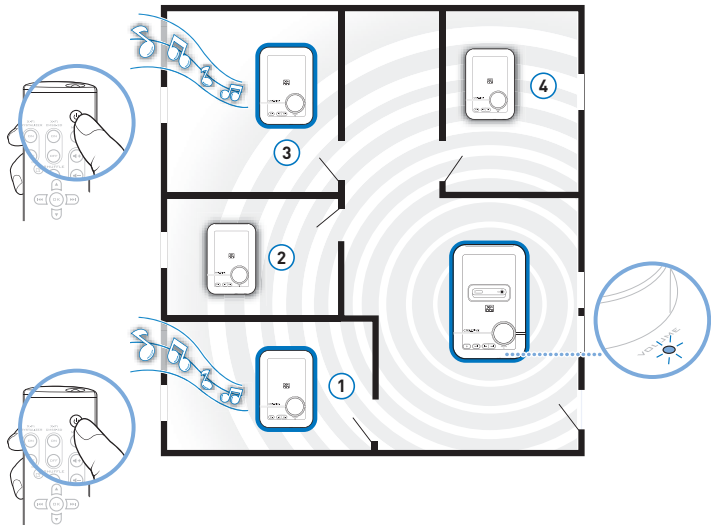

For more information on X-Fi Wireless Receivers, go to [www.creative.com](http://www.creative.com).

## Using X-Fi Enhancements

X-Fi Crystalizer and X-Fi CMSS-3D enhancements have been optimally calibrated for your listening pleasure. Use the remote control to turn the X-Fi Crystalizer or X-Fi CMSS-3D enhancements on or off.

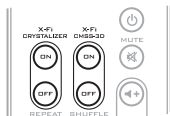

By default, X-Fi Crystalizer and X-Fi CMSS-3D enhancements are enabled. X-Fi CMSS-3D is dependant on your speaker or headphone setup.

**X-Fi CMSS-3D Virtual** - Enjoy immersive surround sound when your Xdock is connected to your Hi-Fi system or any powered stereo speaker system.

**X-Fi CMSS-3D Headphone** - Obtain immersive surround sound when your Xdock is connected to your headphones.

**X-Fi CMSS-3D Surround** - Create multichannel surround sound from stereo recordings by

- connecting the optical cable to the Xdock Optical Out jack.
- using an amplifier or AV receiver that has an Optical In jack and that supports DTS decoding.

## Connecting Headphones

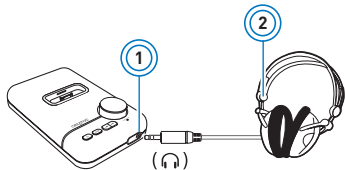

- 1 Headphone jack
- 2 Headphones

**NOTES** Speaker output is automatically disabled when headphones are connected to your Xdock. Disconnect the headphones to enable audio output through your speakers.

## Connecting To An External Stereo Audio Source

To enjoy the X-Fi difference, connect external audio sources (see examples below) to the Line In jack on your Xdock, as shown below.

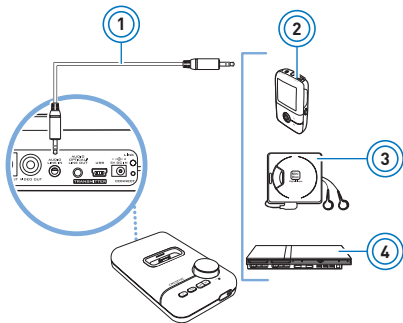

- 1 3.5 mm-to-3.5 mm audio cable (available separately)
- 2 MP3 player
- 3 MiniDisc player
- 4 Gaming console



## Transferring Music From iTunes

With the USB port on your Xdock, you can connect your Xdock to your computer and transfer songs to your iPod using iTunes®.

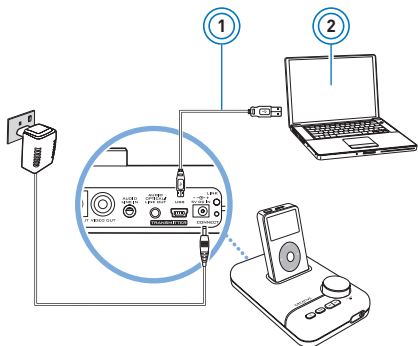

- 1 USB cable (available separately)
- 2 Computer

**NOTES** To learn how to transfer songs to your iPod, refer to your iPod documentation.

## FAQs

This section covers questions you might have while using your product. For further assistance, consult our self-help tool "Knowledge Base". Go to **www.creative.com**, select your region and country, and then select **Support**.

### Why can't I hear any sound from my headphones or speakers?

Check that:

- your speaker system's power is turned on.
- your Xdock is powered from the power adapter.
- the volume is not muted. Press the Mute button on your remote control or the Volume control on your Xdock to unmute.
- you have connected headphones or speakers to your Xdock.
- you have disconnected your headphones from your Xdock. This applies only if you want to hear sound from speakers.

### Why can't I hear much difference in sound after enabling X-Fi Crystalizer?

X-Fi Crystalizer works most dramatically on sound with many high and low frequencies. Some types of music have mostly mid-range frequencies, so the change may not be as apparent.

### Do I need to enable the Equalizer feature in iPod to fully experience X-Fi Xtreme Fidelity?

X-Fi enhancements are best experienced when the Equalizer feature in your iPod is disabled.

## What is the best position for powered stereo speakers when X-Fi CMSS-3D Virtual is enabled?

Good speaker placement can enhance your listening experience, while careless placement can make good audio systems sound bad. Below is our recommendation for powered stereo speakers.

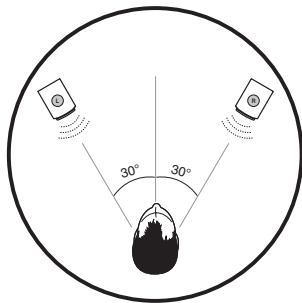

## Can I use noise-cancelling headphones or other special audio-enhancing headphones with Xdock?

When using headphones or earphones with special audio-enhancing features, disable the effects before using them with Xdock. The audio enhancements on the headphones or earphones may interfere with the X-Fi enhancements on Xdock.

## Why do other wireless and electronic devices detect interference when I turn on Xdock?

Your other devices may be detecting signals sent out by Xdock. If you do not have an X-Fi Wireless Receiver, disable the wireless feature.

- i. Press the Power/Standby button to enable Standby mode.
- ii. Disconnect the power adapter from your Xdock.
- iii. Press and hold the Volume control on your Xdock as you reconnect the power adapter to your Xdock. The Link LED lights up and then turns off.

To enable the wireless feature, press and hold both the Previous/Rewind and Next/Fast-forward buttons on your Xdock together for three seconds. The Link LED lights up again.

## Can I change the playback volume using the iPod click wheel?

Your iPod click wheel does not control volume when your player is docked, even when your iPod appears to be registering volume level changes. When your iPod is docked, volume can only be controlled using the Volume control buttons on your remote control or the Volume control on your Xdock.

## Can I use the remote control to display photos on my TV?

No. After connecting your Xdock to a TV (see “Connect Your Xdock” on page 6), press the Play/Pause button on your iPod.

**NOTES** This feature is only applicable to iPod models that support TV Out.

## Why is my remote control not responding?

Your remote control's batteries may have depleted. Replace the batteries.

## Will my saved settings be lost when I unplug my Xdock from the power outlet?

No. If you enable Standby mode before unplugging your Xdock from the power outlet, your settings will be saved (see “Play music” on page 8).

### **Why is my iPod not charging when my Xdock is connected to a computer?**

This may occur if your Xdock is connected to a USB port on a computer that is turned off. Disconnect the USB cable from the back of your Xdock. Charging should start and the charging icon will be displayed on the screen of your iPod.

### **Can I connect my Xdock to a USB hub?**

Using a USB hub with your Xdock may cause your iPod not to be detected by your computer. Always connect your Xdock directly to a computer USB port.

### **Why does my CRT monitor become distorted whenever Xdock is turned on?**

CRT monitors typically have no proper shielding, so their screens may become distorted in the presence of strong magnetic or radio signals. Place your Xdock as far away as possible from your monitor.

### **What happens when I reset Xdock?**

During a reset, your Xdock reverts to the original volume setting, and turns on the X-Fi enhancements. If your Xdock is paired with any X-Fi Wireless Receiver, the zone control settings are also erased.

## How do I remove the Dock adapter?

Remove the Dock adapter as shown below.

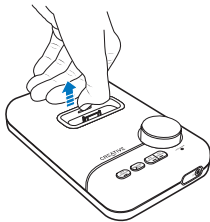

# General Specifications

## Connectivity

- S-Video Out jack
- Video Out jack
- USB Mini-B port
- Audio Optical Out / Line Out - 3.5 mm (1/8") Stereo jack
- Audio Line In - 3.5 mm (1/8") Stereo jack
- Headphone Out - 3.5 mm (1/8") Stereo jack

## X-Fi Technology

- X-Fi Crystalizer
- X-Fi CMSS-3D Surround
- X-Fi CMSS-3D Virtual
- X-Fi CMSS-3D Headphone

## Power Adapter

- Supply Voltage: 5V +/- 5%
- Current: 2.4 A
- Power: 12 W

## Radio frequency (RF)

- Operating RF range: 2400 - 2483.5 MHz
- Number of RF channels: 3
- RF transmitter power output: 16 dBm

## Port compatibility

- Universal Serial Bus (USB) 1.1 and 2.0

## Safety Information

Refer to the following information to use your product safely, and to reduce the chance of electric shock, short-circuiting, damage, fire, hearing impairment or other hazards. **Improper handling may void the warranty for your product. For more information, read the warranty available with your product.**

- Do not dismantle or attempt to repair your product.  
**Refer all servicing to authorized repair agents.**
- Do not expose your product to temperatures outside the range of 0°C to 40°C (32°F to 104°F).
- Do not pierce, crush or set fire to your product.
- Keep your product away from strong magnetic objects.
- Do not subject your product to excessive force or impact.
- Do not expose your product to water or moisture.  
If your product is moisture-resistant, take care not to immerse your product in water or expose it to rain.
- When a conductive apparatus, such as earphones, is used in close proximity with a CRT television or CRT monitor, the latter may emit an electrostatic discharge. The electrostatic discharge can be felt as a static shock. While this static shock is usually harmless, it is good practice to avoid close contact with CRT devices when using earphones.
- Do not listen to audio on your earbuds or headphones at high volume for prolonged periods of time as hearing loss may result. For users in the United States, go to **[www.hei.org](http://www.hei.org)** for more information.
- The battery must be recycled or disposed of properly. Contact local agencies for recycling and disposal information.
- Do not allow metal objects to touch the terminals of your battery.
- If there is leakage, an offensive odor, discoloration or deformation during charging or use, remove the battery and do not use it again. Clean your hands well before touching food or sensitive areas, for example, your eyes.



## European Compliance

This product conforms to the following:

EMC Directive 89/336/EEC as amended by 92/31/EEC and 93/68/EEC.

Mains operated products for the European market comply with Low Voltage Directive 2006/95/EC.

Communication / RF wireless products for the European market comply with R&TTE Directive 1999/5/EC.

**CAUTION:** To comply with the Europe CE requirement, this device must be installed with CE certified computer equipment which meet with Class B limits.

All cables used to connect this device must be shielded, grounded and no longer than 3m in length. Operation with non-certified computers or incorrect cables may result in interference to other devices or undesired effects to the product.

**MODIFICATION:** Any changes or modifications not expressly approved by Creative Technology Limited or one of its affiliated companies could void the user's warranty and guarantee rights.

Information in this document is subject to change without notice and does not represent a commitment on the part of Creative Technology Ltd. No part of this manual may be reproduced or transmitted in any form or by any means, electronic or mechanical, including photocopying and recording, for any purpose without the written permission of Creative Technology Ltd.

Copyright © 2007 Creative Technology Ltd. All rights reserved. The Creative logo, Xdock, X-Fi, CMSS, and Crystalizer are trademarks or registered trademarks of Creative Technology Ltd. in the United States and/or other countries. iPod and iTunes are trademarks or registered trademarks of Apple Inc., registered in the U.S. and other countries. Manufactured under license from DTS, Inc. U.S. Pat. No's. 5,451,942; 5,956,674; 5,974,380; 5,978,762; 6,487,535 and other U.S. and world-wide patents issued and pending. "DTS INTERACTIVE" is a trademark of DTS, Inc. "DTS" is a registered trademark of DTS, Inc. Copyright 1996, 2002-2006 DTS, Inc. All Rights Reserved.

Version 1.0

March 2007