

Introduction

Congratulations on your purchase of Sound Blaster® E7! This high performance USB DAC (Digital-to-Analog Converter) incorporates the advanced Sound Core3D™ audio processor -- the next generation multi-core sound and voice processor for accelerating advanced audio and voice processing technologies. It is designed to work perfectly with your computer and mobile devices, making your audio sound simply amazing while giving you a truly immersive listening experience!

Package Checklist

Your Sound Blaster E7 package comes with the following components.

- The Sound Blaster E7 device
- Headphone stand
- Gold plated 2.0m 3.5mm stereo male to RCA cable for Aux-In
- Gold plated 55mm 3.5mm stereo female to RCA cable for Line-Out (Front L/R)
- 1.5m Micro-USB cable
- 24V 2.91A AC/DC power adaptor
- 1.08m AC power cord

Minimum System Requirements

For computer,

- Intel® Core™ 2 Duo or AMD® equivalent processor, 2.8 GHz or faster recommended
- Intel, AMD or 100% compatible motherboard
- 1GB RAM
- >600 MB of free hard disk space
- Available USB 2.0 port
- Microsoft® Windows® 8.1 64-bit, Windows 8.1 32-bit, OR Windows 8 64-bit, Windows 8 32-bit, OR Windows 7 64-bit, Windows 7 32-bit, OR Windows Vista® 64-bit, Windows Vista 64-bit (Service Pack 1 or higher), OR Mac® OS X® 10.6.8 and above.

For mobile device,

- Android 2.3 and above for Bluetooth®, OR Android 4.1 and above for USB host streaming*;
- iOS 5.0 and above for Bluetooth®, OR iOS 7.0 and above for USB host audio streaming via lightning port.

Note:

*Device's firmware must support USB audio streaming.

Registering Your Product

Registering your product ensures you receive the most appropriate service and product support available. You can register your product during installation or at register.creative.com. Please note that

your warranty rights are not dependent on registration.

More Help

For the latest news and products for the Sound Blaster, please visit www.soundblaster.com. The site also includes information on making purchases, technical help and the latest software updates.

Using Creative Software AutoUpdate

Locating, downloading and installing updates for your Creative products is now simpler and faster with the web-based Creative Software AutoUpdate system.

When you connect to Creative Software AutoUpdate via the Internet, the website will analyze your computer system to determine your operating system, language and which Creative products are connected to your system.

When this analysis is completed, you will then be given a list of only the most relevant software updates for your connected products. The files can then be retrieved and installed.

To learn more about the Creative Software AutoUpdate, please visit www.soundblaster.com/support.

Note:

First-time users of Creative Software AutoUpdate may be prompted to authorize the download of a browser component required for system analysis. Check to ensure that this content is signed by Creative Labs, Inc., then click the **Yes** button.

Please ensure that all your Creative products are connected and installed on the same computer running Creative Software AutoUpdate.

Introduction - 1 -

Introduction - 2 -

About Your Hardware

Your USB audio device is equipped with a variety of input and output jacks to enable connection to various devices. Other controls give you basic control over the system's functions.

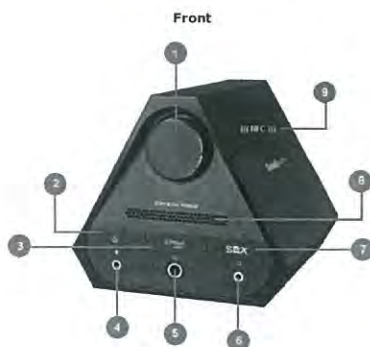

Control or Jack	Description
1	Playback Volume/Mute knob Turn clockwise or counterclockwise to increase or decrease the playback volume. Push to mute/unmute playback volume.
2	Power/Bluetooth button/indicator Press the button once to power Sound Blaster E7 ON. Press again to power it OFF. When it is turned ON, press and hold the button for 2 seconds to enter Bluetooth pairing mode.
3	Dolby Digital indicator Lights up in white when Dolby Digital decoding is activated.
4	Mic-In jack Connects to a microphone using a 3.50 mm (1/8-inch) stereo jack.
5	6.3mm Headphone 1 jack Connects to stereo headphones using a 6.3 mm (1/4-inch) stereo jack.
6	3.5mm Headphone 2 jack Connects to stereo headphones using a 3.50 mm (1/8-inch) stereo jack.
7	SBX button/indicator Toggles SBX Pro Studio audio enhancements ON/OFF. The SBX Pro Studio is ON when the LED is lighted and dimmed otherwise.

About Your Hardware - 3 -

Control or Jack	Description
8	Built-In Microphone Array For voice pickup and recording.
9	NFC sensor Tap NFC device to connect.

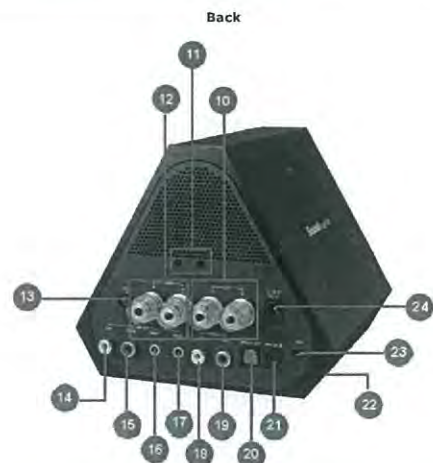

Control or Jack	Description
10	Speaker Output terminal (Left) Connects to the Left input of passive speakers.
11	Headphone Stand slots For installing the supplied headphone stand.
12	Speaker Output terminal (Right) Connects to the Right input of passive speakers.
13	Amplifier switch Slide switch to turn speaker amplifier ON/OFF.
14	RCA Line-Out jack (Front Right) Connects to the Front Right input on powered analog speakers or an A/V receiver.
15	RCA Line-Out jack (Front Left) Connects to the Front Left input on powered analog speakers or an A/V receiver.
16	3.5mm Rear-Out jack (Rear L/R) Connects to the Rear Left and Rear Right inputs on powered analog speakers or an A/V receiver.

About Your Hardware - 4 -

	Control or Jack	Description
17	3.5mm Center/Subwoofer-Out jack	Connects to the Centre and Subwoofer inputs on powered analog speakers or an A/V receiver.
18	RCA Line-In jack (Left)	Connects to the Left output on line-level sources (for example, MP3 players).
19	RCA Line-In jack (Right)	Connects to the Right output on line-level sources (for example, MP3 players).
20	Optical S/PDIF-Out jack	Connects to recording devices with optical connectors (for example, Digital Audio Tape recorders, MiniDisc recorders or external A/V receivers).
21	Optical S/PDIF-In jack	Connects to playback devices with optical connectors (for example, Digital Audio Tape players, MiniDisc players, DVD players or televisions with optical output).
22	USB Host port	Connects to mobile devices (for example, smartphones and tablets) for audio streaming. You may also charge your mobile devices with this port.
23	USB port	Connects to the USB port of a PC/laptop for audio streaming via a Micro-USB cable.
24	DC-In port	Connects to a supplied 24V 2.91A AC/DC power adaptor.

Setting Up Your Audio Device

Step 1: Connecting to a Power Supply

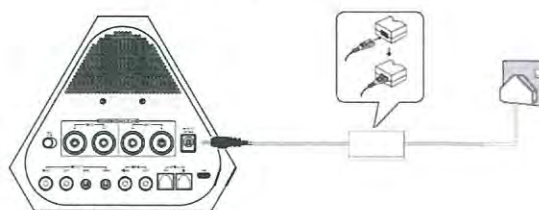

Turning On Sound Blaster E7

Press the **Power/Bluetooth** button to turn on Sound Blaster E7. The **Power/Bluetooth** indicator lights up in white once the device is properly connected and turned on.

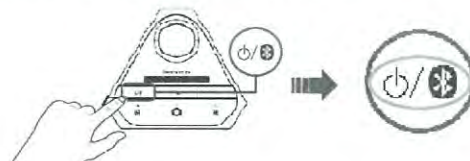

Note:

Sound Blaster E7 fully boots up within 6 seconds. It's ready to play audio when the **Power/Bluetooth** indicator lights up in white.

Step 2: Connecting to an Audio Source

Connecting to a Computer via USB

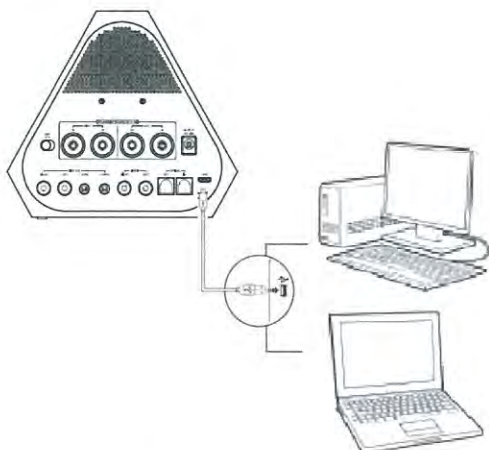

Setting the default audio device

For Windows:

After the Sound Blaster E-Series Control Panel is installed, Sound Blaster E7 will be automatically set as the default audio device. Alternatively, you can set the desired default audio device from the Windows Sound Control Panel.

For Mac:

1. Go to **System Preferences** and click **Sound**.
2. Select **Sound Blaster E7** in the **Output** tab.
3. In the **Input** tab, select **Line-In** or **Mic-In/Mic Array**.

Connecting to a Mobile Device via USB Host

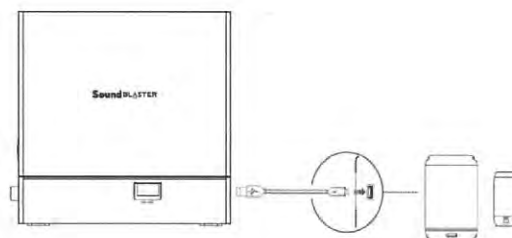

Connecting to Line-In Sources (e.g. MP3 Player, CD Player)

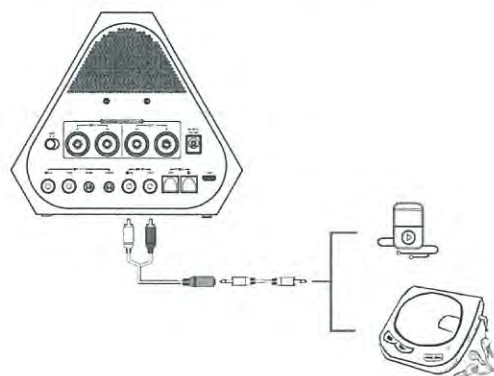

Connecting to Optical-In Sources (e.g. DVD/Blu-ray Player, TV Set)

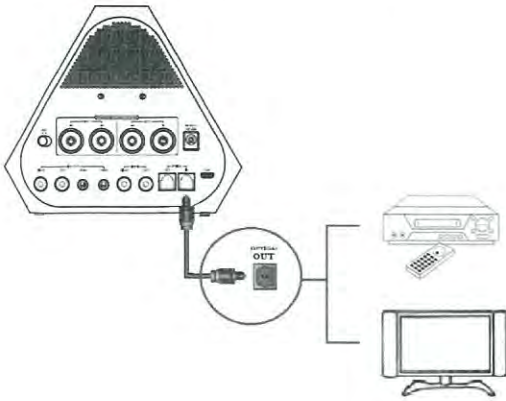

Connecting to Bluetooth Devices

To enjoy your favorite music from your *Bluetooth* devices, simply follow these steps to connect your devices.

i. Activate Bluetooth pairing mode on Sound Blaster E7

Turn on Sound Blaster E7. Press and hold the **Power/Bluetooth** button for 5 seconds. The **Power/Bluetooth** indicator will begin to blink in blue while waiting to be connected.

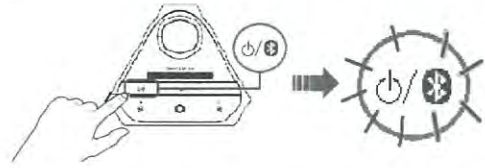

Note:

If no device is paired within 2 minutes, it will exit from pairing mode.

ii. Activate Bluetooth pairing mode on your mobile device

Activate *Bluetooth* on your mobile device. From the list of discovered *Bluetooth* devices, select "Sound Blaster E7".



Note:

Bluetooth pairing between these devices may vary depending upon the model type. Consult your device's manual on how to pair.

iii. Pairing success

When both devices are paired, the **Power/Bluetooth** indicator will light in blue.

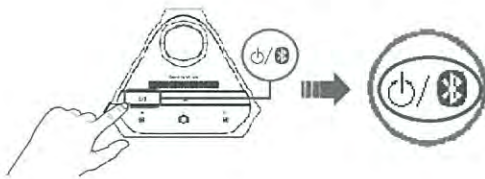

Pairing Multiple Devices

The Sound Blaster E7 supports multipoint *Bluetooth* connection. It can be connected to two *Bluetooth* devices at the same time! To have the second device paired, repeat steps i to iii on **Connecting to Bluetooth Devices**. If you wish to connect it with a third device, one of the two devices that are currently paired with the audio device has to be disconnected.

One Touch Pairing with NFC

You may pair your NFC-enabled device with Sound Blaster E7 with a single tap using the NFC technology. Simply follow these steps to connect them.

i. Activate NFC on your mobile device

Turn on the NFC feature on your mobile device by enabling "NFC" on the "Settings" screen.

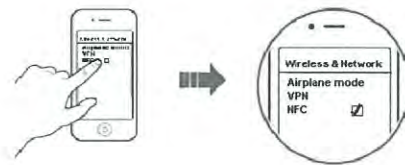

Note:

Some of these settings may vary depending on the device's model type. Consult your device's manual on how to activate NFC.

ii. Tap your mobile device on Sound Blaster E7

Touch your mobile device on the NFC logo on Sound Blaster E7 to connect.



Note:

Be sure that your mobile device is NFC-enabled and find out where the NFC sensor is located on your device. Consult your device's manual for more information.

Aim the device's sensor at the NFC logo on Sound Blaster E7 before tapping the devices.

iii. Pairing success

When both devices are paired, the **Power/Bluetooth** indicator will light in blue.

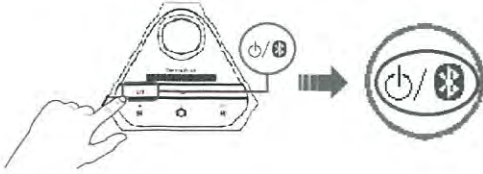

To disconnect, tap your device with Sound Blaster E7 again.

Step 3: Connecting to Speakers / Headphones

Connecting to Passive Speakers

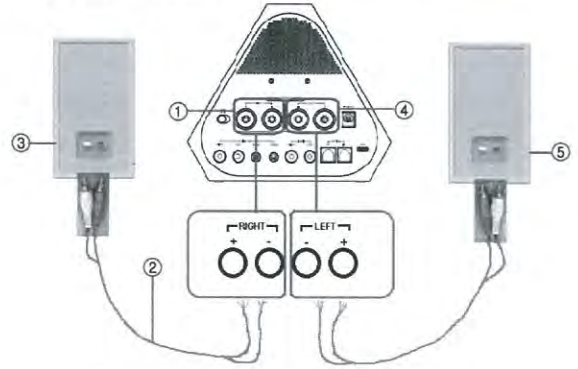

Component	
1	Speaker Output terminal (Right)
2	Speaker cords
3	Speaker (Right)
4	Speaker Output Terminal (Left)
5	Speaker (Left)

Speaker Cables

There are three different types of speaker cables or connectors that can be attached to the Speaker Output terminals (Right and Left) of Sound Blaster E7. Ensure that the rubber covers are removed from the binding posts before attaching the speaker cables.

i. Bare Wires



1. Turn the binding post of the Speaker Output terminal counter-clockwise to reveal the metal hole in the binding post.
2. Tightly twist the bare wire and insert it into the hole. Ensure that the polarities of the wires match. For example, connect the wire from the positive (red/white) terminal on each speaker to the corresponding positive terminal on your receiver. Similarly, connect the wire from the negative (black) terminal on each speaker to the negative terminal on your receiver.
3. Tighten the binding post to the speaker cable by rotating clockwise.

ii. Spade Lug



1. Turn the binding post of the Speaker Output terminal counter-clockwise to reveal the metal hole in the binding post.
2. Slide the open part of the U-shaped connector over the binding post. Ensure that the polarities of the wires match.
3. Tighten the binding post to the speaker cable by rotating clockwise.

iii. Banana Plug

Simply push the banana plug into the binding post of the Speaker Output terminal. Ensure that the polarities of the wires match.



Turn On the Amplifier

Slide the **Amplifier** switch to turn it ON. After use, slide the switch back to deactivate it.

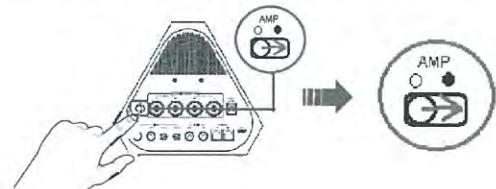

Note:

Only applicable when Sound Blaster E7 is connected to passive speakers.

Connecting to Analog Speaker Systems

2.1 Channel Analog Speakers

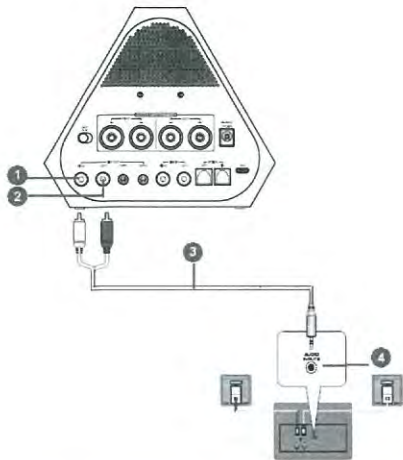

Component	
1	RCA Line-Out jack (Front Right)
2	RCA Line-Out jack (Front Left)
3	RCA to Stereo cable
4	Audio Input jack

Setting Up Your Audio Device - 17 -

Component	
8	Front (Audio Input) jack
9	Rear (Audio Input) jack
10	Center/Subwoofer (Audio Input) jack

Setting Up Your Audio Device - 19 -

5.1 Channel Analog Speakers

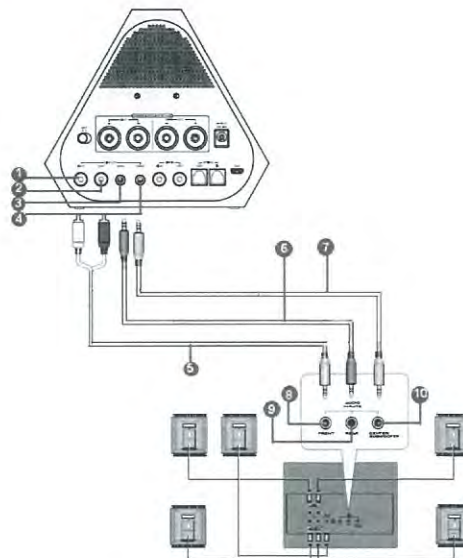

Component	
1	RCA Line-Out jack (Front Right)
2	RCA Line-Out jack (Front Left)
3	3.5mm Rear-Out jack (Rear L/R)
4	3.5mm Center/Subwoofer-Out jack
5	RCA to Stereo cable
6	2-channel audio cable
7	2-channel audio cable

Setting Up Your Audio Device - 18 -

Connecting to Digital Speaker Systems

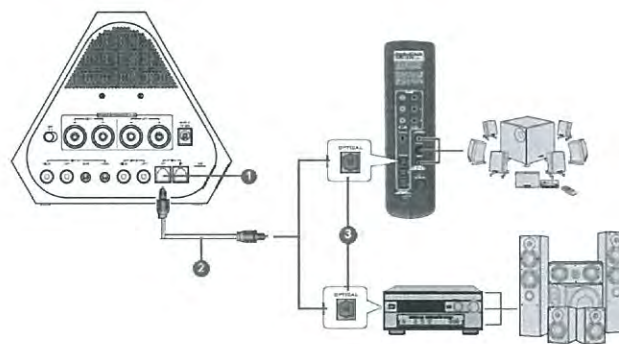

Component	
1	Optical S/PDIF-Out jack
2	Optical cable
3	Optical S/PDIF-In jack

Setting Up Your Audio Device - 20 -

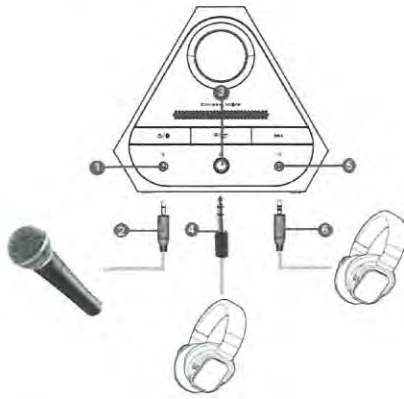

	Component
1	3.5mm Microphone jack
2	3.5mm Microphone plug
3	6.3mm Headphone 1 jack
4	6.3mm Headphone plug
5	3.5mm Headphone 2 jack
6	3.5mm Headphone plug

Note:

When headphones and a line-out device are connected simultaneously, audio will output to the headphones.

Installing and Uninstalling Software

To take full advantage of your Sound Blaster E7 audio device, you need to install device drivers and applications. At times, you may also need to uninstall some or all of the device drivers and applications to correct problems, change configurations, or upgrade outdated drivers or applications. To learn how to do so in all supported Windows and Mac operating systems, consult the following sections:

- Installing Drivers and Applications
- Uninstalling Drivers and Applications

Installing Drivers and Applications

Ensure that your audio device is connected before proceeding. For instructions on installing your audio device, consult your Quick Start leaflet.

After you have connected your audio device, turn on your computer. Windows automatically detects your audio device and searches for device drivers.

For Windows OS

1. Using a standard web browser, visit support.creative.com and locate the software package for the Windows operating system.
2. Download this package into your local hard disk.
3. Locate and launch the software package.
4. Follow the on-screen instructions to complete the installation.
5. When prompted, restart your computer.

For Mac OS

1. Using your web browser, visit support.creative.com and locate the software package for the Mac OS.
2. Download this package into your local hard disk.
3. Double-click the downloaded file to uncompress it.
4. Double-click the uncompress DMG file.
5. Double-click the **Install** icon and follow the subsequent on-screen instructions to complete the installation.



Uninstalling Drivers and Applications

In the event that an uninstallation is required (such as for upgrades), please follow the following procedure.

Before you begin, close all running audio applications. Applications that are still running during uninstallation will not be removed.

For Windows OS

1. From the **Control Panel**, click **Uninstall a program**.
2. Select your audio device's entry.
3. Click the **Uninstall** button or option.
If the **User Account Control** dialog box appears, click the **Continue** button.
4. Click the **Yes** button.
5. When prompted, restart your computer.

For Mac OS

1. Click **Applications > Creative > Creative Uninstaller**
2. Select the Creative product to be uninstalled.
3. Click the **Uninstall** button.
4. Follow the on-screen instructions.

Using the Creative Software Suite

A specialized software for the Sound Blaster E7 is developed to provide additional enhancements to the audio and voice inputs and outputs of the product. The software bundle supports a range of operating systems including:

- Windows 8.1, Windows 8, Windows 7, Windows Vista
- Mac OS X 10.6.8 or higher
- iOS v5 or higher
- Android v2.3 or higher

To take full advantage of your audio device, we recommend downloading and installing this software into your computer. The following applications are included in the software bundle:

For Windows OS,

- Sound Blaster E-Series Control Panel
- Creative Smart Recorder
- Creative WaveStudio
- Creative Host OpenAL
- Creative Alchemy
- Creative Software AutoUpdate
- Creative System Information
- Creative Online Registration

For Mac OS,

- Sound Blaster E-Series Control Panel
- Creative Online Registration

For iOS and Android,

- Sound Blaster Central

Note:

Some applications are available only for certain operating systems. To learn more about each application, please consult its respective Online Help.

Sound Blaster E-Series Control Panel



Configuring Your Software Settings

Click each feature to access its settings page. More information on each feature can be found in their respective sections in this manual.



Using the Creative Software Suite - 25 -

SBX Pro Studio Settings



Enhancing Your Listening Experience

You can adjust the amount to apply for each enhancement by dragging its slider left to decrease or right to increase. To test the effects of the audio enhancements, click and listen to the demo video.

- **SBX Pro Studio Surround** provides immersion control of sounds not just around you, but also above and below for a full 3D audio experience. Hear the natural sense of audio depth, spaciousness and stunning 3D surround effects from your audio content. Enjoy an unbelievably true-to-life audio experience, whether it's over stereo speakers or headphones.
- **SBX Pro Studio Crystalizer** restores the dynamic range that is lost when iTunes and MP3 music gets compressed. This makes the music sound as good as the artist originally intended, and adds an enhanced level of realism for movies and games.
- **SBX Pro Studio Bass** fills in the low frequency tones and gives the extra impact for a better entertainment experience. It dramatically improves the sound experience without a subwoofer.
- **SBX Pro Studio Smart Volume** addresses the problem of abrupt volume level changes during playback and between songs by automatically and continuously measuring volume, and intelligently applying gain and attenuation to compensate for those changes.
- **SBX Pro Studio Dialog Plus** enhances the voices in movies for clearer dialog, allowing the listener to hear the dialog over the rest of the soundtrack and over ambient noise in the listening environment.

Using the Creative Software Suite - 26 -

CrystalVoice Settings



Having Fun with CrystalVoice

After configuration, click and speak into your microphone to hear how your voice sounds with CrystalVoice applied. Readjust as desired.

CrystalVoice FX enables the speaker's voice to be altered with a variety of effects, which can be used to enhance the tone of the speaker's voice, create interesting accents or to sound like a completely different person.

CrystalVoice Smart Volume automatically adjusts the loudness of the speaker's voice to maintain a consistent volume level. This makes it convenient for the speaker to converse normally, regardless of whether the speaker is close to or far away from the microphone.

CrystalVoice Noise Reduction enables the speaker to be heard clearly over background noise by constantly monitoring the environment and eliminate the unwanted noise that interferes with the conversation.

CrystalVoice Acoustic Echo Cancellation eliminates echoes and enables the speaker to listen to the other party clearly. Echoes are a common problem present in voice communication systems that disrupts conversations by making it difficult to hear the other party.

CrystalVoice Focus creates a zone and suppresses noise outside it to enable the speaker within to be heard with amazing clarity. Multiple microphones are used to focus, enhance the speaker's voice, and eliminate sounds outside the zone.

Using the Creative Software Suite - 27 -

Speakers/Headphones Settings

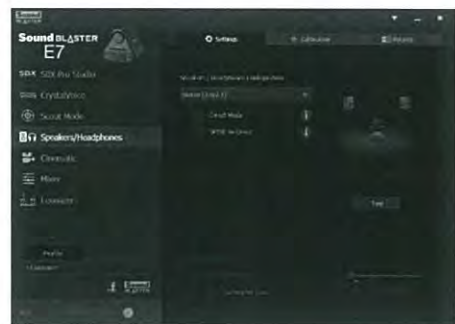

1. Switch between Speakers or Headphones mode.
2. Speakers / Headphones Configuration
Select your current physical speakers or headphones configuration.
3. For headphones, select the gain for headphone out:
 - Normal Gain (32/300 ohm headphones)
 - High Gain (600 ohm headphones)



WARNING!
Setting to high gain may damage your headphones if their impedance does not match the specified level of 600 ohms.
4. Option to set to high gain by default.
Select Always set to high gain when in headphones configuration. This check box is only applicable when **High Gain** is being selected as shown in the figure below.

Using the Creative Software Suite - 28 -

Mixer Settings



1. Volume sliders
Adjust the playback and recording volume for your various inputs and outputs.
2. Mixer Settings

Click the  icon to mute/unmute the input/output. You can click the  icon to adjust the settings for your input/output.

Equalizer Settings



1. EQ presets
Select an equalizer preset to apply to your audio.
2. EQ sliders
Adjust the equalizer settings.

Customizing Your EQ Settings

Select the EQ checkbox to enable this feature, then click the EQ drop-down arrow and select a preset from the list.

Selecting a preset will move the EQ sliders to the appropriate values. You can then adjust the equalizer setting by dragging the sliders up or down to the desired level. Click  to save the new configuration as a new preset.

Note:

The list of default EQ presets cannot be deleted or overwritten.

General Specifications

Controls and Indicators

- Power/Bluetooth button/indicator
- Playback Volume/Mute knob
- Dolby Digital indicator
- SBX button/indicator
- Amplifier switch
- Bluetooth wireless
- NFC sensor

Inputs

- One 3.5 mm (1/8") Microphone-In jack
- Built-In Microphone Array
- Two RCA Line-In jacks
- One Optical S/PDIF-In jack
- One USB port
- One USB Host port
- One DC-In port

Outputs

- One 3.5 mm (1/8") Headphone 1 jack
- One 6.35 mm (1/4") Headphone 2 jack
- One Optical S/PDIF-Out jack
- Four 3.5mm (1/8-inch) Line-Out jacks for six channel analog audio output:
Front Left, Front Right, Front Center, Subwoofer, Rear Left and Rear Right channels
- Four Speaker Output terminal for connecting to the Left and Right inputs of passive speakers

Technical Specifications

- Operating Temperature Range: 0°C to 40°C
- Audio Codec: AAC, SBC, aptX®, aptX-L (Low Latency)
- USB Host Port Output: 5 V ⚡ 2.1 A
- Power Adapter:
 - Input: 100 V - 240 V, 1.5 A 50/60 Hz
 - Output: 24 V ⚡ 2.91 A 69.84 W
- Power Consumption:
 - Standby/Power Off: < 0.5 W
 - Networked Standby (i.e. when Bluetooth is linked and/or USB is connected without audio streaming): < 3.0 W
 - When Bluetooth is linked and no device is connected via audio input, the Sound Blaster E7 will power down automatically within 15 minutes. To activate or deactivate Bluetooth, refer to **Connecting to Bluetooth devices**.
- Bluetooth Technology:
 - Version: Bluetooth 4.1 LE (Low Energy)

- Bluetooth Profiles:
 - i. A2DP (Wireless Stereo Bluetooth)
 - ii. AVRCP (Bluetooth Remote Control)
 - iii. HFP (Hands-Free Profile)
- Operating Frequency: 2402 - 2480 MHz
- Operating Range: Up to 10 meters / 33 feet
(Measured in open space. Walls and structures may affect range of device.)

Note:

Compliance markings are located at the bottom of this product

Troubleshooting and Support

This section provides solutions to problems you may encounter during installation or normal use. This includes:

- Problems with Sound
- Different Statuses of the LED Indicators

Problems with Sound

No sound from the headphones connected to Sound Blaster E7.

Check the following:

- The headphones are connected to the Headphone jack of Sound Blaster E7.
- In the Speakers/Headphones selection of Sound Blaster E-Series Control Panel, the **Headphones** option is selected.

No audio output from speakers when playing digital files.

Check the following:

- The Sound Blaster E7 and speakers' Volume Control knob are set at mid-range. Adjust the Volume Mixer settings in Sound Blaster E-Series Control Panel, if necessary.
- The powered speakers are connected to the Line-Out jack, OR the passive speakers are connected to the Speaker Output terminals.
- The Speakers/Headphones selection in Sound Blaster E-Series Control Panel corresponds to your speaker or headphone configuration.

No audio from the microphone/line-in can be heard from the source connected to Line-In or Mic-In jack.

Do the following:

- In the **Mixer** selection of Sound Blaster E-Series Control Panel, go to **Mic-In/Line-In** option under **REC**, click , and enable **Listen to this device**.

No audio can be recorded from the source connected to Line-In or Mic-In jack.

Do the following:

- Navigate to **Windows Control Panel > Sound > Recording** tab.
- Select **Mic-In/Line-In** as the default recording device.
- In the **Mixer** selection of Sound Blaster E-Series Control Panel, unmute the **Mic-In/Line-In** from **REC** option.

Different Statuses of the LED Indicator

The Sound Blaster E7 is equipped with LED indicators that display the statuses of the device. Each LED indicator, their possible statuses and corresponding explanations are listed in the tables below:

Action	LED Indicator	Status
Press the Power/Bluetooth button.	Power/Bluetooth indicator lights up in white.	Sound Blaster E7 is powered on.
Press the Playback Volume/Mute knob.	Power/Bluetooth indicator flashes slowly in white.	Audio is muted.
Turn the Playback Volume/Mute knob to maximum level.	Power/Bluetooth indicator blinks three times in white.	Volume is at maximum.
Press and hold the the Power/Bluetooth button for 2 seconds.	Power/Bluetooth indicator blinks in blue.	Bluetooth pairing/discovery mode.
In Bluetooth pairing/discovery mode, connect your Bluetooth device to Sound Blaster E7 .	Power/Bluetooth indicator lights up in blue.	Bluetooth is connected. Ready to stream music.
Press the SBX button.	SBX indicator lights up in white.	SBX effect is turned on.
Play Dolby Digital encoded audio.	Dolby Digital indicator lights up in white.	Dolby Digital decoding is activated.

Additional Support

If you encounter any other issues or have any other enquiries about your Sound Blaster E7 or any other Creative products, please visit our comprehensive knowledge base at support.creative.com or www.soundblaster.com for additional information.

Safety Information

Refer to the following information to use your product safely, and to reduce the chance of electric shock, short-circuiting, damage, fire, hearing impairment or other hazards. **Improper handling may void the warranty for your product. For more information, read the warranty available with your product.**

- Do not dismantle or attempt to repair your product.
Refer all servicing to authorized repair agents.
- Do not expose your product to temperatures outside the range of 0°C to 40°C (32°F to 104°F).
- Do not pierce, crush or set fire to your product.
- Keep your product away from strong magnetic objects.
- Do not subject your product to excessive force or impact.
- Do not expose your product to water or moisture.
If your product is moisture-resistant, take care not to immerse your product in water or expose it to rain.
- Use a mains plug that is appropriate for your country or region.
- To be completely disconnected from the power input, the mains plug has to be disconnected / detached from the mains.
- Disconnect the mains plug when the device is expected to be unused for several days.

Additional guidelines for Bluetooth devices

- The short wave radio frequency signals of a **Bluetooth** device may impair the operation of other electronic and medical devices.
- Switch off the device where it is prohibited. Do not use the device in medical facilities, aircraft, refueling points, close to automatic doors, automatic fire alarms or other automatically controlled devices.
- Keep this device at least 20 cm from pacemakers and other medical devices. Radio waves may impair the operation of pacemakers and other medical devices.

[FR] Informations de sécurité

Consultez les informations suivantes pour utiliser votre produit en toute sécurité et pour réduire les risques de choc électrique, mise en court-circuit, dégât, incendie, perte auditive ou tout autre danger. **Toute mauvaise utilisation peut annuler la garantie de votre produit. Pour toutes informations complémentaires, lisez la garantie fournie avec votre produit.**

- Vous ne devez ni démonter ni tenter de réparer votre produit.
Toute opération de maintenance doit être confiée à un réparateur agréé.
- N'exposez pas votre produit à des températures en dehors de la plage de températures de 0° C à 40° C.
- Ne percez pas le produit, ne l'écrasez pas et veillez à ce qu'il ne prenne pas feu.
- Tenez votre produit éloigné d'objets fortement magnétiques.
- Ne soumettez pas le produit à une force ou à un impact excessif.
- N'exposez pas votre produit à l'eau ou à l'humidité.
Même si votre produit est résistant à l'humidité, évitez de l'immerger dans l'eau ou de l'exposer à la pluie.
- Utilisez une prise électrique correspondant à votre pays ou à votre région.
- Pour mettre l'appareil complètement hors tension, débranchez le câble d'alimentation de la prise secteur.

- Débranchez le câble d'alimentation de la prise secteur lorsque l'appareil risque de rester inutilisé pendant plusieurs jours.

Lignes directrices supplémentaires pour les périphériques Bluetooth

- Les fréquences radio à ondes courtes émises par un périphérique **Bluetooth** peuvent perturber le fonctionnement des autres appareils électroniques et médicaux.
- Arrêtez l'appareil si son utilisation est interdite.
- N'utilisez pas cet appareil à moins de 20 cm d'un simulateur cardiaque ou d'autres appareils médicaux.

[IT] Informazioni sulla sicurezza

Leggere attentamente le informazioni riportate di seguito per utilizzare il dispositivo in modo sicuro e minimizzare i rischi di scosse elettriche, cortocircuiti, danni, incendi, lesioni all'udito o di altra natura. **Un uso non corretto potrebbe invalidare la garanzia del prodotto. Per ulteriori informazioni, consultare la garanzia fornita con il prodotto.**

- Non smontare o provare a riparare il prodotto.
Per tutti gli interventi di manutenzione, rivolgersi agli agenti autorizzati.
- Non esporre il dispositivo a temperature inferiori a 0 °C o superiori a 40°C.
- Non perforare, rompere o incendiare il dispositivo.
- Non usare il dispositivo vicino a oggetti che possono generare forti campi magnetici.
- Non sottoporre il dispositivo a forti pressioni o urti violenti.
- Non esporre il prodotto all'acqua o all'umidità.
Se il prodotto resiste all'umidità, prestare attenzione a non immergere il prodotto in acqua o ad esporlo alla pioggia.
- Utilizzare una spina dell'alimentazione di rete adeguata per il paese o la regione di utilizzo.
- Per scollegare completamente il dispositivo dall'alimentazione, la presa deve essere scollegata dalla rete elettrica.
- Scollegare la presa se si prevede di non utilizzare il dispositivo per diversi giorni.

Linee guida aggiuntive per dispositivi Bluetooth

- I segnali a onde corte di frequenza utilizzati dai dispositivi **Bluetooth** possono ostacolare il funzionamento di altri dispositivi elettronici e medici.
- Spegnerne il dispositivo nei luoghi in cui ne è proibito l'utilizzo.
- Mantenere il dispositivo ad almeno 20 cm da pacemaker e altri dispositivi medici.

[DE] Sicherheitsinformationen

Lesen Sie die folgenden Hinweise, um Ihr Produkt sicher anzuwenden und die Risiken von elektrischen Schlägen, Kurzschlüssen, Beschädigungen, Bränden, Gehörschäden oder anderen Gefahren zu reduzieren. **Unsachgemäße Handhabung kann zum Erlöschen der Gewährleistung Ihres Produktes führen. Weitere Informationen sind in der Garantieerklärung enthalten, die dem Produkt beiliegt.**

- Das Produkt nicht öffnen und keine eigenen Reparaturversuche unternehmen.
Alle Service-Vorgänge von autorisiertem Reparaturpersonal durchführen lassen.
- Setzen Sie Ihr Produkt keinen Temperaturen unter 0°C oder über 40°C aus.
- Das Produkt darf nicht durchbohrt, zerdrückt oder in Brand gesteckt werden.
- Bewahren Sie das Produkt oder die Batterie nicht in der Nähe stark magnetischer Gegenstände auf.
- Setzen Sie das Produkt keiner übermäßigen Kraft- oder Aufpralleinwirkung aus.

- Das Produkt nicht Regen oder Feuchtigkeit aussetzen. Falls Ihr Produkt feuchtigkeitsbeständig ist, darauf achten, dass das Produkt nicht in Wasser eingetaucht oder dem Regen ausgesetzt wird.
- Verwenden Sie einen landesüblichen Netzstecker.
- Für die vollständige Trennung von der Stromversorgung muss der Netzstecker vom Stromnetz getrennt (aus der Steckdose gezogen) werden.
- Ziehen Sie den Netzstecker, wenn Sie das Gerät mehrere Tage nicht verwenden möchten.

Zusätzliche Sicherheitshinweise für Bluetooth-Geräte

- Die Kurzwellen-Funksignale eines Bluetooth-Geräts können den Betrieb anderer elektronischer und medizinischer Geräte stören.
- Schalten Sie das Gerät in Bereichen ab, in denen die Nutzung verboten ist.
- Halten Sie dieses Gerät mindestens 20 cm von Herzschrittmachern oder anderen medizinischen Geräten entfernt.

[ES] Información sobre seguridad

Consulte la siguiente información para usar el producto de forma segura y reducir así las posibilidades de que se produzcan descargas eléctricas, cortocircuitos, averías, incendios, lesiones auditivas u otros accidentes. **El uso inadecuado puede anular la garantía del producto. Para obtener más información, lea la garantía disponible con el producto.**

- No desmonte ni intente reparar el producto.
- **Deje todas las tareas de reparación en manos de agentes de reparación autorizados.**
- No exponga el producto a temperaturas que no estén entre los 0 °C y los 40 °C (32 °F a 104 °F).
- No agujeree, aplaste ni prenda fuego al producto.
- Mantenga el producto alejado de objetos magnéticos potentes.
- No someta el producto a una presión excesiva y evite que reciba golpes.
- No deje que el producto quede expuesto al agua ni a la humedad. Si su producto es resistente a la humedad, tenga cuidado de no introducirlo en el agua ni exponerlo a la lluvia.
- Utilice un enchufe de corriente que sea apropiado para su país o región.
- Para desconectar completamente la entrada de alimentación, debe desenchufar el cable alimentación de red de la toma de corriente.
- Desconecte el enchufe de alimentación de red cuando no vaya a utilizar el dispositivo durante varios días.

Instrucciones adicionales para dispositivos Bluetooth

- Las señales de radiofrecuencia de onda corta de un dispositivo Bluetooth pueden afectar al funcionamiento de otros dispositivos electrónicos o médicos.
- Apague el dispositivo en los lugares en los que se prohíba su uso.
- Mantenga el dispositivo a más de 20 cm de marcapasos u otros dispositivos médicos.

[NL] Veiligheidsinformatie

Raadpleeg de volgende informatie voor veilig gebruik van uw product en om het risico op elektrische schokken, kortsluitingen, brandgevaar, gehoorbeschadiging en andere problemen te verminderen. **Door onjuist gebruik kan de garantie op dit product vervallen. Lees de garantievoorwaarden die bij uw product zijn meegeleverd voor meer informatie.**

- Demonteer het product niet of probeer het niet te repareren.
- **Laat al het onderhoud over aan geautoriseerde agente voor herstelling.**

Safety Information - 37 -

- Stel het product niet bloot aan temperaturen buiten het bereik van 0 °C tot 40 °C.
- Het product niet doorboren, pletten of in vuur steken.
- Het apparaat niet blootstellen aan sterk magnetische objecten.
- Zorg ervoor dat het apparaat niet blootstaat aan overmatige druk of trillingen.
- Uw product niet blootstellen aan water of vochtigheid. Als uw product vochtbestendig is, let er dan op om uw product niet onder te dompelen in water of bloot te stellen aan de regen.
- Gebruik het type stekker dat in uw land of regio wordt gebruikt.
- Om te zorgen voor een volledige afsluiting van de stroomvoorziening moet de stekker uit het stopcontact worden verwijderd.
- Haal de stekker uit het stopcontact wanneer u het apparaat enkele dagen niet gaat gebruiken.

Aanvullende richtlijnen voor draadloze apparaten

- De radiofrequentiesignalen in de korte golf van een Bluetooth-apparaat kunnen de werking van andere elektronische en medische apparatuur verstoren.
- Schakel het apparaat uit op locaties waar het verboden is het apparaat aan te hebben staan.
- Houd dit apparaat op een afstand van minstens 20 cm van pacemakers en medische apparaten vandaan.

[PT] Informações de segurança

Consulte as informações a seguir para usar o produto com segurança e reduzir as chances de choques elétricos, curtos-circuitos, danos, incêndios, problemas auditivos ou outros riscos. **O uso indevido do produto pode invalidar a sua garantia. Para mais informações, leia a garantia fornecida com o produto.**

- Não desmonte nem tente consertar o seu produto. **Consulte os serviços de manutenção nos agentes autorizados.**
- Não exponha o produto a temperaturas fora da faixa de 0°C a 40°C (32°F a 104°F).
- Não perfure, quebre ou incinere o produto.
- Mantenha o produto longe de objetos magnéticos.
- Não exponha o produto a força ou impacto excessivos.
- Não exponha o seu produto à água ou umidade. Se o seu produto for resistente à umidade, cuidado para não colocar o seu produto na água nem deixar exposto à chuva.
- Utilize uma ficha elétrica apropriada ao seu país ou região.
- Certifique-se de que desliga a ficha de alimentação da corrente elétrica.
- Desligue a ficha de alimentação se o dispositivo não for utilizado durante um longo período de tempo.

Directrices adicionais para dispositivos sem fios

- Os sinais de frequência de rádio de onda curta de um dispositivo Bluetooth poderão impedir o funcionamento de outros dispositivos electrónicos e médicos.
- Desligue o dispositivo onde for proibida a sua utilização.
- Mantenha este dispositivo a pelo menos 20 cm de pacemakers e outros dispositivos médicos.

[SV] Säkerhetsinformation

Läs följande information för att använda produkten på ett säkert sätt och för att minska risken för elektriska stötar, kortslutning, skada, eld, hörselskada eller andra faror. **Felaktig hantering kan**

göra att produktens garanti upphör att gälla. Mer information finns i garantin som medföljer produkten.

- Montera inte isär produkten, och försök inte utföra reparationer av den.
- **Allt service- och reparationsarbete måste utföras av behöriga reparatörer.**
- Utsätt inte produkten för temperaturer under 0 °C och över 40 °C.
- Borra inte i produkten, krossa den inte och sätt inte eld på den.
- Håll produkten borta från starka magnetiska objekt.
- Utsätt inte produkten för våld eller stötar.
- Utsätt inte produkten för fukt eller väta. Produkten får inte sänkas ner i vätska eller utsättas för regn, även om den är fuktållig.
- Använd en strömkontakt som fungerar för ditt land eller område.
- För att koppla från en nätanslutning fullständigt måste nätkontakten tas ur nätuttaget.
- Koppla ur nätkontakten om enheten inte ska användas under en längre tid (flera dagar).

Viktig information om Bluetooth-enheter

- Kortvågsradiosignaler från en Bluetooth-enhet kan orsaka störningar på andra elektroniska och medicinska apparater.
- Stäng av enheten där användning är förbjuden.
- Enheten måste användas på minst 20 cm avstånd från pacemakers och annan medicinsk utrustning.

[NO] Sikkerhetsinformasjon

Les denne informasjonen for å bruke spilleren trygt, og for å redusere mulighetene for elektriske støt, kortslutning, skade, brann, hørselsskade eller andre farer. **Urikkelig behandling kan gjøre garantien til produktet ugyldig. Les garantien til produktet for å få mer informasjon.**

- Ikke demonter eller forsøk å reparere produktet.
- **La autorisert servicepersonell ta seg av all service.**
- Ikke utsett produktet for temperaturer utenfor området 0 til 40 °C.
- Ikke stikk hull på, knus eller sett fyr på produktet.
- Hold produktet borte fra sterkt magnetiske gjenstander.
- Ikke utsett produktet for store påkjenninger eller støt.
- Ikke utsett produktet for vann eller fuktighet. Hvis produktet tåler fuktighet, må du passe på å ikke senke produktet i vann eller utsette det for regn.
- Bruk en nettplugg som passer for ditt land eller region.
- For å koble helt fra strømmen må kontakten kobles fra strømuttaket.
- Koble enheten fra strømuttaket når den ikke skal brukes på noen dager.

Ekstra retningslinjer for Bluetooth-enheter

- Kortbølgeradiosignaler fra en Bluetooth-enhet kan påvirke bruken av andre elektroniske og medisinske enheter.
- Slå av enheten på steder der den ikke skal brukes.
- Hold enheten minst 20 cm fra pacemakere og annet medisinsk utstyr.

[DK] Sikkerhedsoplysninger

Gennemlæs følgende oplysninger, så du kan bruge produktet på sikker vis samt reducere risikoen for elektrisk støt, kortslutning, beskadigelse, brand, tab af hørelse eller andre farer. **Ukorrekt**

håndtering kan opheve garantien på produktet. Du finder flere oplysninger ved at læse garantien, der følger med produktet.

- Undlad at skille produktet ad eller forsøge at reparere det.
- **Overlad al service til autoriserede teknikere.**
- Produktet må ikke udsættes for temperaturer uden for området 0 °C til 40 °C.
- Undlad at lave hul i produktet, knuse det eller sætte ild til det.
- Hold produktet væk fra stærkt magnetiske objekter.
- Udsæt ikke produktet for overdreven fysisk magt.
- Udsæt ikke produktet for vand eller fugt.
- Hvis produktet er fugtavisende, skal du sørge for ikke at nedsænke produktet i vand eller udsætte det for regn.
- Brug et netstik, der passer til dit land eller din region.
- Strømmen afbrydes helt ved at tage stikket ud af stikkontakten.
- Afbryd på hovedkontakten, når enheden ikke skal anvendes i flere dage.

Yderligere retningslinjer for Bluetooth-enheder

- De radiofremte kortbølgesignaler fra en Bluetooth-enhed kan forringe funktionen af andre elektriske og medicinske enheder.
- Sluk enheden, hvor den er forbudt.
- Hold denne enhed mindst 20 cm væk fra pacemakere og andre medicinske enheder.

[FI] Turvallisuustiedot

Lue nämä tiedot huolellisesti, jotta osaat käyttää tuotetta turvallisesti. Näin vähennät sähköiskun, oikosulun, laitevaurion, tulipalon ja kuulovaurion vaaraa sekä muita vaaratilanteita. **Takuu ei korvaa väärästä käytöstä aiheutuneita vahinkoja. Lisätietoja takuusta on takuutodistuksessa.**

- Älä pura äläkä yritä korjata tuotetta.
- **Vie huollon tarpeessa oleva tietokone valtuutetulle huoltajalle.**
- Älä altista laitetta alle 0 °C:n tai yli 40 °C:n lämpötiloilille.
- Älä lävistä, murskaa tai polta laitetta.
- Älä säilytä laitetta magneettisten esineiden läheisyydessä.
- Älä altista laitetta iskulle tai kohdistu siihen suurta voimaa.
- Älä altista tuotetta vedelle tai kosteudelle. Jos tuote on kosteusuojattu, älä upota tuotetta veteen tai altista sitä sateelle.
- Käytä maassasi tai alueellasi käytössä olevaa verkkopistoketta.
- Virransaannin katkaiseminen kokonaan edellyttää, että virtajohdon pistoke on irrotettu pistoraslasta.
- Irrota virtajohdon pistoke pistoraslasta, kun odotat laitteen olevan käyttämättä muutaman päivän ajan.

Bluetooth-laitteisiin liittyviä lisäohjeita

- Bluetooth-laitteen lyhytaaltoiset radiosignaalit voivat häiritä muiden elektroniikka- ja lääkintälaitteiden toimintaa.
- Sammuta laite paikoissa, joissa sen käyttö on kiellettyä.
- Pidä tämä laite vähintään 20 cm:n etäisyydellä sydämentahdistimista ja muista lääkintälaitteista.

Safety Information - 39 -

Safety Information - 40 -



[CZ] Bezpečnostní informace

Následující informace se týkají bezpečného používání výrobku a snížení rizika úrazu elektrickým proudem, zkratu, požáru, poškození sluchu a dalších rizik. **Při nevhodné manipulaci může záruka na výrobek pozbyť platnosti. Další informace získáte v příloženém záručním listu.**

- Nerozebírejte výrobek ani se ho nepokoušejte opravit.
- **Veškeré opravy nechte provádět v autorizovaných opravárnách.**
- Nevystavujte výrobek teplotám mimo rozsah 0 až 40 °C.
- Výrobek nepropichujte, nepromačkávejte ani nevystavujte ohni.
- Nevystavujte výrobek působení silného magnetického pole.
- Nevystavujte výrobek nadměrnému tlaku ani úderům.
- Nevystavujte výrobek vlhkosti.
- Pokud je výrobek odolný proti vlhkosti, dávejte pozor, abyste jej neponořili do vody a nevystavujte jej dešti.
- Používejte zástrčku, která je vhodná pro vaši zemi či region.
- Chcete-li zařízení úplně odpojit od sítě, musíte vytáhnout zástrčku ze zásuvky.
- Kabel napájení vytáhněte ze zásuvky vždy, když předpokládáte, že zařízení nebudete několik dní používat.

Další pokyny pro zařízení s rozhraním Bluetooth

- Krátkovlnné rádiové signály zařízení s rozhraním Bluetooth mohou narušit funkci jiných elektronických a lékařských zařízení.
- Vypněte zařízení, je-li jeho použití zakázáno.
- Vzdálenost mezi zařízením a kardiostimulátory či jinými lékařskými zařízeními by neměla být menší než 20 cm.

[PL] Informacje dotyczące bezpieczeństwa

Poniższe informacje dotyczą bezpiecznego korzystania z produktu i zminimalizowania zagrożeń związanych z porażeniem prądem elektrycznym, zwarciami, uszkodzeniem sprzętu, pożarem, uszkodzeniem słuchu oraz innymi zagrożeniami. **Niewłaściwe korzystanie może spowodować unieważnienie gwarancji produktu. Aby uzyskać więcej informacji, przeczytaj gwarancję dołączoną do urządzenia.**

- Nie należy rozmontowywać produktu lub podejmować prób jego naprawy.
- **Wszystkie prace serwisowe powinien wykonywać uprawniony personel.**
- Nie narażać produktu na temperatury przekraczające zakres od 0°C do 40°C.
- Produktu nie należy przebijać, zgniatać lub zapalać.
- Produktu nie należy zbliżać do urządzeń wytwarzających silne pole magnetyczne.
- Nie wolno narażać produktu na nadmierne wstrząsy lub uderzenia.
- Nie należy narażać produktu na działanie wody lub wilgoci.
- Jeśli produkt jest odporny na wilgoć, nie należy go zanurzać w wodzie ani wystawiać na deszcz.
- Korzystaj z wtyczki zasilania odpowiedniej dla danego kraju lub regionu.
- Aby całkowicie odłączyć urządzenie od zasilania, należy wyjąć wtyczkę przewodu zasilania z gniazda.
- Jeśli urządzenie nie będzie używane przez dłuższy czas, należy odłączyć je od zasilania.

Safety Information - 41 -

Dodatkové wskazówki dotyczące urządzeń Bluetooth

- Przesyłane przy użyciu fal krótkich sygnały radiowe urządzeń Bluetooth mogą mieć wpływ na działanie innych urządzeń elektronicznych i medycznych.
- Urządzenie należy wyłączać w miejscach, w których jego używanie jest zabronione.
- Należy zachować co najmniej 20 cm odległości między urządzeniem a rozrusznikiem serca i innymi urządzeniami medycznymi.

[HU] Biztonsági információk

Olvassa el a következő információkat a termék biztonságos használatára, valamint az áramütésveszély, rövidzárlat, károsodás, tűz, halláskárosodás és más veszélyek elkerülése érdekében. **Helytelen kezelés esetén érvénytelené válhat a termékre vonatkozó garancia. További információért olvassa el a termékhez tartozó jótállást.**

- A termék szétszerelésére vagy javítására ne tegyen kísérletet.
- **Bizsa az összes javítást hivatalos szervizszakemberre.**
- Ne tegye ki a terméket 0-40°C-on kívüli hőmérsékletnek.
- Ne szurkálja, ne törje össze és ne gyújtsa fel a terméket.
- Tartsa távol a terméket az erősen mágneses tárgyaktól.
- Ne tegye ki a terméket nagy erőhatásnak.
- Ne tegye ki a terméket víz vagy nedvesség hatásának.
- Amennyiben a termék nem vízálló, gondoskodjon arról, hogy a termék ne kerüljön vízbe, illetve ne érje eső.
- Az országnak vagy régiójának megfelelő tápcsatlakozót használjon.
- Az áramellátás teljes megszüntetéséhez a dugót ki kell húzni a hálózatról.
- Ha a készüléket előreláthatóan néhány napig nem használja, húzza ki a dugaszt.

További tudnivalók a Bluetooth készülékekről

- A Bluetooth készülékek rövidhullámú rádiófrekvenciái megzavarhatják más elektronikus vagy orvosi berendezések működését.
- Ahol a készülék használatra tilos, kapcsolja ki azt.
- A készüléket legalább 20 cm távolságra helyezze a pacemakerektől és más orvosi műszerektől.

[EL] Πληροφορίες Κανονισμών

Ανατρέξτε στις ακόλουθες πληροφορίες για να χρησιμοποιείτε το προϊόν με ασφάλεια και για να ελαττώσετε τον κίνδυνο πρόκλησης ηλεκτροπληξίας, βροχικού κλάματος, βλάβης, πυρκαγιάς, προβλημάτων ακοής και άλλου τύπου κινδύνων. **Ο ακατάλληλος χειρισμός ενδέχεται να καταστήσει άκυρη την εγγύηση του προϊόντος. Για περισσότερες πληροφορίες, ανατρέξτε στην εγγύηση που συνοδεύει το προϊόν.**

- Μην αποσυναρμολογήσετε και μην προσπαθήσετε να επισκευάσετε το προϊόν.
- **Για οποιαδήποτε επισκευή, απευθυνθείτε σε εξουσιοδοτημένους αντιπροσώπους επισκευής.**
- Το προϊόν δεν πρέπει να εκτίθεται σε θερμοκρασίες εκτός του εύρους των 0°C έως 40°C (32°F έως 104°F).
- Μην τριψάψτε, μη συνθλίψετε και μη βλάψτε φωτιά στο προϊόν.
- Κρατήστε το προϊόν μακριά από αντικείμενα με ισχυρό μαγνητικό πεδίο.
- Μην σκεπάζετε υπερβολικά δύσκολο όταν χρησιμοποιείτε το προϊόν και μην το υποβάλλετε σε σοκ.

Safety Information - 42 -

- Το προϊόν δεν πρέπει να εκτίθεται σε νερό ή υγρασία.
- Αν το προϊόν σας είναι ανθεκτικό στην υγρασία, μην το βυθίζετε σε νερό και μην το εκθέτετε στην βροχή.
- Χρησιμοποιήστε βύσματα κατάλληλα για την περιοχή ή τη χώρα σας.
- Για να αποσυνδεθείτε τελείως από την είσοδο τροφοδοσίας, θα πρέπει να αποσυνδέσετε/αφαιρέσετε το φις τροφοδοσίας από την τροφοδοσία.
- Αποσυνδέστε το βύσμα τροφοδοσίας όταν δεν πρόκειται να χρησιμοποιήσετε τη συσκευή για αρκετές ημέρες.

Επιπλέον οδηγίες για συσκευές Bluetooth

- Τα σήματα ραδιοσυχνότητας βροχέων κυμάτων μιας συσκευής Bluetooth μπορεί να παρεμποδίσουν τη λειτουργία άλλων ηλεκτρονικών και ιατρικών συσκευών.
- Ανεργονοποιείτε τη συσκευή σε χώρους όπου απαγορεύεται η χρήση της.
- Η συσκευή πρέπει να έχει πάντοτε ελάχιστη απόσταση 20 εκ. από βιολογικούς και άλλες ιατρικές συσκευές.

[LT] Saugos informacija

Remdamiesi informacija, gaminiu naudosis saugiai, todėl sumažes elektros šokų, trumpojo jungimo, pažeidimų, gaisro, klausos pablogėjimo ar kitokios žalos pavojus. **Dėl netinkamo naudojimosi gaminiu gali būti panaikinta garantija. Norėdami gauti išsamesnės informacijos, skaitykite garantiją, kurią gavote su gaminiu.**

- Neardykite ir nebandykite taisyti šio gaminio.
- **Visą priežiūrą patikėkite igalioiems remonto įmonės atstovams.**
- Nelaikykite gaminio žemesnėje kaip 0 C (32 F) ir aukštesnėje kaip 40 C (104°F) temperatūroje.
- Nebadykite, nespauskite, neuždekite gaminio.
- Laikykite gaminį atokiau nuo stiprių magnetinių laukų turinčių objektų.
- Saugokite gaminį nuo didelės jėgos poveikio ar smūgio.
- Pasirūpinkite, kad gaminio nepaveiktų vanduo ar drėgmė.
- Jei gaminius atsparus drėgmei, vis tiek nemerkite jo į vandenį ir nelaikykite lietuje.
- Naudokite kištukinį lizdą, kuris tinkamas Jūsų regione arba šalyje.
- Norint visiškai atjungti įrenginį nuo maitinimo šaltinio, reikia iš elektros tinklo lizdo ištraukti maitinimo kištuką.
- Jei neketinate įrenginį naudoti kelias dienas, ištraukite maitinimo laido kištuką iš tinklo.

Papildomos belaidžių įrenginių naudojimo rekomendacijos

- Trumpųjų bangų radijo dažnio signalas, sklindantis iš Bluetooth įrenginio, gali trikdyti kitų elektroninių ir medicininių įrenginių veikimą.
- Išjunkite įrenginį atsidūrę vietose, kuriose draudžiama jį naudoti.
- Šį įrenginį laikykite bent 20 cm atstumu nuo širdies stimuliatorių ir kitų medicininių įrenginių.

[SK] Bezpečnostné informácie

Ak chcete, aby bola prevádzka výrobku bezpečná a aby sa obmedzilo nebezpečenstvo úrazu elektrickým prúdom, skratu, hmotných škôd, požiaru, poškodenia sluchu či iné nebezpečenstvo, prečítajte si nasledujúce informácie. **Nesprávne používanie výrobku môže zapríčiniť ukončenie platnosti záruky. Podrobnejšie informácie nájdete v záručnom liste výrobku.**

- Výrobok nerozoberajte ani neopravujte.
- **Servis a opravy zverzte kvalifikovaným servisným technikom.**
- Nevystavujte výrobok teplotám pod 0 °C a nad 40 °C.

Safety Information - 43 -

- Výrobok sa nesmie prepichovať, lámať ani zapalovať.
- Chráňte výrobok pred pôsobením silného magnetického poľa.
- Nevystavujte výrobok pôsobeniu nadmernej sily či tlaku.
- Nevystavujte výrobok vode ani vlhkosti.
- Ak je výrobok odolný proti vlhkosti, dbajte na to, aby sa neponořil do vody ani nezmokol.
- Použite zástrčku, ktorá sa používa vo vašej krajine alebo regióne.
- Úplné odpojenie od napájania zabezpečíte odpojením a vytiahnutím sieťovej zástrčky z elektrickej siete.
- Keď predpokládáte, že zariadenie nebudete používať niekoľko dní, vytiahnite sieťovú zástrčku.

Doplnkové pokyny pre zariadenia Bluetooth

- Signály krátkych vln (rádiové) frekvencie zariadenia Bluetooth môžu narušať prevádzku iných elektronických a medicínskych zariadení.
- Keď je používanie zariadenia zakázané, vypnite ho.
- Toto zariadenie udržiavajte vo vzdialenosti minimálne 20 cm od kardiostimulátorov alebo iných medicínskych zariadení.

[RU] Техника безопасности

Ознакомьтесь с информацией, содержащейся в данном разделе, чтобы обеспечить условия безопасного использования изделия и снизить риск поражения электрическим током, возникновения короткого замыкания, нанесения травм, возгорания, ухудшения слуха и прочих опасностей. **Неправильная эксплуатация изделия может привести к аннулированию гарантии. Дополнительную информацию см. в гарантийном документе, входящем в комплект поставки.**

- Не разбирайте и не пытайтесь самостоятельно ремонтировать изделие.
- **Все работы по техническому обслуживанию и ремонту должны проводить квалифицированные специалисты.**
- Запрещено эксплуатировать устройство при температурах ниже 0°C (32°F) и выше 40°C (104°F).
- Запрещено пробивать или повреждать корпус устройства и бросать его в огонь.
- Держите устройство вдали от источников мощных магнитных полей.
- Запрещено подвергать изделие сильному механическому воздействию и ударам.
- Запрещено подвергать изделие воздействию воды или влажности.
- Если продукт устойчив к влажности, не погружайте его в воду и не выносите под дождь.
- Используйте сетевую вилку, соответствующую типу электророзетки в данной стране или регионе.
- Для полного отключения питания необходимо отсоединить разъем питания от источника питания.
- Если устройство не будет использоваться в течение нескольких дней, отключите его от источника питания.

Дополнительные рекомендации в отношении устройств Bluetooth

- Коротковолновые сигналы устройства Bluetooth могут повлиять на работу других электронных и медицинских устройств.
- Отключайте устройство в местах, где его использование запрещено.
- Устройство должно находиться на расстоянии не менее 20 см от кардиостимуляторов и других медицинских устройств.

Safety Information - 44 -

[TR] Informations sécuritaires

Reportez-vous aux informations suivantes pour utiliser votre produit en toute sécurité et réduire les risques de choc électrique, de court-circuit, de dégâts, d'incendie, de perte auditive et autres risques. **Une manipulation non appropriée peut entraîner l'annulation de la garantie de votre produit. Pour plus d'informations, lisez la garantie fournie avec votre produit.**

- Ne démontez pas et n'essayez pas de réparer votre produit. **Confiez toute tâche d'entretien à des agents de réparation autorisés.**
- N'exposez pas votre produit à des températures extérieures inférieures à 0° C ou supérieures à 40° C.
- Ne percez pas, n'écrasez pas et n'enflammez pas votre produit.
- Tenez votre produit éloigné des objets fortement magnétiques.
- Ne soumettez pas votre produit à une pression ou un impact excessif.
- N'exposez pas votre produit à l'eau ni à l'humidité. Si votre produit est résistant à l'humidité, prenez soin de ne pas l'immerger dans l'eau ni de l'exposer à la pluie.
- Yaşadığınız ülkeye ya da bölgeye uygun bir fiş kullanın.
- Elektrik girişinden tamamen bağlantıyı kesmek için, fişin prizden çıkarılmış ya da bağlantısı kesilmiş olmalıdır.
- Cihazı birkaç gün kullanmayacaksanız fişini prizden çekin.

Bluetooth cihazları için ek bilgi

- Bluetooth cihazlarının kısa dalga radyo frekans sinyalleri diğer elektronik ve tıbbi cihazların çalışmasını etkileyebilir.
- Kullanılmasına izin verilmeyen yerlerde cihazı kapatın.
- Cihazı kalp pili ve diğer tıbbi cihazlardan en az 20 cm uzakta tutun.

[CS] 安全信息

请参考以下信息，以安全地使用产品，减少触电、短路、损坏、起火、听力损伤等危险发生的可能。使用不当会使您的产品无法获得保修服务。详情请参阅产品附带的保修说明。

- 不要擅自拆卸或尝试修理产品。所有相关服务应交与授权的维修处理人员。
- 不要将产品放置在 0°C 至 40°C (32°F 至 104°F) 范围之外的环境中。
- 不要刺穿、挤压或燃烧产品。
- 将产品远离具有强磁场的物体。
- 不要使产品受到强大外力冲击。
- 不要使产品浸水或放在潮湿的环境中。即使您的产品具备防潮功能，也请注意不要使其浸水或淋雨。
- 使用的电源插头要适用于您所在的国家或地区。
- 要彻底切断电源，需要拔下主插头或断开主插头与主机的连接。
- 如果设备闲置几天不用，需断开其与主插头的连接。

蓝牙设备补充说明

- 蓝牙设备发出的短波无线电频率信号可能会影响其他电子设备和医疗设备的正常使用。
- 在禁止使用的地方请关掉设备。
- 在距电子起搏器或其他医疗设备 20 cm 的范围以内请勿使用此设备。

[CT] 安全資訊

為避免觸電、產品短接、損壞、起火、聽力損害或其他危險，請參閱以下資訊獲取產品的安全使用說明。使用不當可能導致您的產品保固失效。詳情請閱讀產品附帶的保固資訊。

- 不要拆卸或嘗試自行維修產品。所有維修和相關服務應交由授權的維修代理進行。
- 不要在 0°C 至 40°C (32°F 至 104°F) 這個範圍之外的溫度下存放或使用產品。
- 不要刺穿、擠壓或焚燒產品。
- 遠離強磁場的物件。
- 不要重壓或用力擠碰。
- 避免沾水，遠離潮濕環境。即使產品具有防潮特性，也注意不要將其浸入水中或被雨淋。
- 使用您在國家或地區通用的電源插頭。
- 如要與電源輸入完全分開連接，必須將電源插頭從電源上斷開/拔下。
- 如果裝置在數日內不用，請將電源插頭斷開。

藍芽裝置的額外指示

- 藍芽裝置的短波無線電訊號可能影響其他電子和醫療裝置的正常執行。
- 在禁止使用該裝置的場所將其關閉。
- 將此裝置與心律調節器和其他醫療裝置保持至少 20 cm 的距離。

[JP] 安全性に関する情報

製品を安全にご使用いただき、感電、漏電、損傷、火災、聴力障害、またはその他の危険を避けるため、下記の情報をお読みください。不適切な取扱いが原因とみなされる場合、製品の保証が無効になる場合があります。詳細については、製品に付属の保証書をお読みください。

- 製品をお客様ご自身で修理、分解しないでください。修理に関しては製品を購入された国 / 地域のカスタマーサポートサービスにご連絡下さい。
- ご使用の製品を 0 - 40 の範囲を超える温度下に置かないでください。
- 製品に穴を開けたり、壊したり、火中に投げしないでください。
- 製品を強い磁気のそばに置かないでください。
- 製品に強い衝撃を与えないでください。
- 製品を濡らしたり、湿気のあるところに置かないでください。製品が耐湿性の場合、水中に浸したり、雨に濡らしたりしないでください。
- 日本国内向け製品用の主電源プラグを使用し、100Vの電源にてお使い下さい。
- 電源入力を完全に切断するには、電源プラグをコンセントから抜きます。
- デバイスを数日間使用しない場合は、電源プラグをコンセントから抜いて下さい。

ワイヤレスデバイス用の追加ガイドライン

- Bluetoothデバイスの短波無線周波数信号は、他の電子機器や医療機器の動作に悪影響を及ぼすことがあります。
- 使用を禁止されている場所ではデバイスの電源をお切りください。
- このデバイスはペースメーカーや他の医療機器から20cm以上離してください。

[KR] 안전 정보

다음의 정보를 참고하여 제품을 안전하게 사용하고, 감전, 단락, 손상, 화재, 청력 손실 및 기타 위험의 발생 가능성이 있음을 줄이십시오. 부주의하게 취급하는 경우 제품 보증금을 받지 못할

수도 있습니다. 자세한 내용은 제품 보증서를 읽어보십시오.

- 직접 제품을 분해하거나 수리하지 마십시오. 모든 서비스는 공인 서비스 대행업체에 문의하십시오.
- 0°C ~ 40°C (32°F ~ 104°F) 범위 이외의 온도에서 제품을 노출하지 마십시오.
- 제품에 구멍을 뚫거나 부수거나 손상하지 마십시오.
- 제품을 자기성이 강한 물체가 가까이 두지 마십시오.
- 제품에 과도한 힘이나 충격을 가하지 마십시오.
- 제품을 물이나 수분에 노출하지 마십시오. 내수성 제품인 경우 제품을 물에 젖거나 비에 노출되지 않도록 주의하십시오.
- 사용하는 국가 또는 지역에 적합한 메인 플러그를 사용하십시오.
- 전원을 완전히 차단하려면 메인 플러그의 연결을 해제해야 합니다.
- 머칠 동안 장치를 사용하지 않을 때에는 메인 플러그의 연결을 해제하십시오.

우선 장치에 대한 추가 지침

- Bluetooth 장치의 단파 라디오 주파수 신호는 다른 전자 및 의료 장비의 작동에 영향을 미칠 수 있습니다.
- 사용이 금지된 곳에서는 장치를 끄십시오.
- 이 장치를 심장 박동 조절 장치 및 기타 의료 장비에서 최소 20cm 멀리 두십시오.

Regulatory Information

The following sections contains notices for various countries.

Caution:

This product is intended for use with FCC/CE certified computer equipment. Please check the equipment operating/installation manual and/or with the equipment manufacturer to verify/confirm if your equipment is suitable prior to the installation or use of the product.

Notice for the USA

Federal Communication Commission (FCC) Interference Statement

FCC PART 15: This equipment has been tested and found to comply with the limits for a Class B digital device, pursuant to Part 15 of the FCC Rules. These limits are designed to provide reasonable protection against harmful interference in a residential installation. This equipment generates, uses and can radiate radio frequency energy and, if not installed and used in accordance with the instructions, may cause harmful interference to radio communications. However, there is no guarantee that interference will not occur in a particular installation. If this equipment does cause harmful interference to radio or television reception, which can be determined by turning the equipment off and on, the user is encouraged to try to correct the interference by one or more of the following measures:

- Reorient or relocate the receiving antenna.
- Increase the separation between the equipment and receiver.
- Connect the equipment into an outlet on a circuit different from that to which the receiver is connected.
- Consult the dealer or an experienced radio/TV technician for help.

This device complies with part 15 of the FCC Rules. Operation is subject to the following two conditions:

- This device may not cause harmful interference, and
- This device must accept any interference received, including interference that may cause undesired operation.

Caution:

To comply with the limits of the Class B digital device, pursuant to Part 15 of the FCC Rules, this device must be installed with computer equipment certified to comply with Class B limits.

All cables used to connect to the computer and peripherals must be shielded and grounded. Operation with non-certified computers or non-shielded cables may result in interference to radio or television reception.

MODIFICATION: Any changes or modifications not expressly approved by the grantee of this device could void the user's authority to operate the device.

Federal Communication Commission (FCC) Radiation Exposure Statement

Power is so low that no RF exposure calculation is needed.

Notice for Canada

This Class B digital apparatus complies with Canadian ICES-003 and RSS-210.

Cet appareil numérique de la classe B est conforme aux normes canadiennes NMB-003 et CNR-210.

This device complies with Industry Canada licence-exempt RSS standard.

Operation is subjected to the following two conditions:

1. This device may not cause harmful interference, and
2. This device must accept any interference received, including interference that may cause undesired operation.

Cet appareil est conforme avec Industrie Canada RSS standard exempts de licence.

Son fonctionnement est soumis aux deux conditions suivantes :

1. Le matériel ne peut être source d'interférences et
2. Doit accepter toutes les interférences reçues, y compris celles pouvant provoquer un fonctionnement indésirable.

CANADIAN CLASS B STATEMENT: This digital device does not exceed the Class B limits for radio noise emissions from digital apparatus as set out in the interference-causing equipment standard entitled "Digital Apparatus," ICES-003 of the Department of Communications.

Cet appareil numérique respecte les limites de bruits radioélectriques applicables aux appareils numériques de Classe B prescrites dans la norme sur le matériel brouilleur. "Appareils Numériques," NMB-003 édictée par le ministre des Communications.

MODIFICATION: Any changes or modifications not expressly approved by the grantee of this device could void the user's authority to operate the device.

Toute modification non approuvée explicitement par le fournisseur de licence de l'appareil peut entraîner l'annulation du droit de l'utilisateur à utiliser l'appareil.

European Compliance



This product conforms to the following:

EMC Directive 2004/108/EC.

RoHS Directive 2011/65/EU.

Mains operated products for the European market comply with Low Voltage Directive 2006/95/EC and Commission Regulation(s) Implementing Directive 2009/125/EC.

Communication / RF wireless products for the European market comply with R&TTE Directive 1999/5/EC.

CAUTION: To comply with the Europe CE requirement, this device must be installed with CE certified computer equipment which meet with Class B limits.

All cables used to connect this device must be shielded, grounded and no longer than 3m in length. Operation with non-certified computers or incorrect cables may result in interference to other devices or undesired effects to the product.

MODIFICATION: Any changes or modifications not expressly approved by Creative Technology Limited or one of its affiliated companies could void the user's warranty and guarantee rights.

[FR] European Compliance

Ce produit est conforme aux normes suivantes :

Directive 2004/108/CE sur les émissions électromagnétiques.

Directive RoHS 2011/65/UE.

Les produits secteur pour le marché européen sont conformes à la Directive sur la faible tension 2006/95/CE et à la réglementation de la Commission exécutant la Directive 2009/125/CE.

Les produits de communication/sans fil RF destinés au marché européen sont conformes à la directive R&TTE 1999/5/CE.

ATTENTION : pour respecter les critères CE d'Europe, cet appareil doit être installé avec du matériel informatique certifié CE respectant les limites de la classe B. Tous les câbles utilisés pour connecter cet appareil doivent être blindés, reliés à la terre et ne pas faire plus de 3 m de long. L'utilisation d'ordinateurs non certifiés ou de câbles inappropriés peut entraîner des interférences avec d'autres appareils ou des effets indésirables sur le produit.

MODIFICATION : toute modification non approuvée explicitement par Creative Technology Limited ou l'une de ses sociétés affiliées peut entraîner l'annulation de la garantie et des droits de garantie de l'utilisateur.

[IT] Conformità alle normative europee

Questo prodotto è conforme alla seguente normativa:

Direttiva EMC 2004/108/CE.

Direttiva RoHS 2011/65/UE.

I prodotti che funzionano con corrente di rete per il mercato europeo sono conformi alla direttiva bassa tensione 2006/95/CE e alla direttiva di implementazione nelle normative europee 2009/125/CE.

I prodotti di comunicazione/wireless RF per il mercato europeo sono conformi alla Direttiva R&TTE 1999/5/CE.

ATTENZIONE: ai fini della conformità con i requisiti del marchio CE europeo, il dispositivo deve essere installato in un computer certificato CE conforme ai limiti di Classe B. Tutti i cavi usati per collegare il

Regulatory Information - 49 -

Regulatory Information - 50 -

dispositivo devono essere schermati, dotati di idonea messa a terra e avere una lunghezza massima di 3 metri. L'uso del dispositivo con computer non certificati o cavi non idonei può provocare interferenze ad altri dispositivi nonché danneggiare il prodotto stesso.

MODIFICHE: eventuali modifiche o alterazioni non espressamente approvate da Creative Technology Limited o dalle sue società controllate possono rendere nulli la garanzia e il diritto dell'utente a utilizzare il prodotto.

[DE] Einhaltung der europäischen Bestimmungen

Dieses Produkt erfüllt die folgenden Bestimmungen:

EMC-Richtlinie 2004/108/EG.

RoHS-richtlinie 2011/65/EU.

Netzbetriebene Produkte für den europäischen Markt erfüllen die Niederspannungsverordnung 2006/95/EG und der Commission Regulation(s) Implementing-Verordnung 2009/125/EG.

Drahtlose Kommunikationsgeräte/Funksender und -empfänger für den europäischen Markt erfüllen die R&TTE-Richtlinie 1999/5/EG.

ACHTUNG: Um die Anforderungen der europäischen CE-Norm zu erfüllen, muss dieses Produkt an einem CE-geprüften Computer der Klasse B angeschlossen werden. Alle Verbindungskabel zu diesem Gerät müssen abgeschirmt und geerdet sein und dürfen nicht länger als 3 m sein. Der Betrieb mit nicht zertifizierten Computern oder nicht ordnungsgemäßen Kabeln kann zu Störungen anderer Geräte oder unerwünschten Auswirkungen auf das Produkt führen.

MODIFIZIERUNG: Jegliche Änderung oder Modifizierung des Produkts, die nicht ausdrücklich von Creative Technology Limited oder einer der zugehörigen Firmen genehmigt worden ist, kann für den Benutzer zum Erlöschen der Garantie und der Gewährleistungsrechte führen.

[ES] Homologación para Europa

Este producto cumple:

la Directiva de compatibilidad electromagnética 2004/108/CE.

Directiva RoHS 2011/65/UE.

Los productos funcionando con corriente eléctrica cumplen con la Directiva 2006/95/CE de baja tensión y con la implementación de los requisitos de la Comisión para la Directiva 2009/125/CE.

Los productos inalámbricos de comunicación o frecuencias de radio para el mercado europeo cumplen la Directiva 1999/5/CE de equipos de radio y terminales de telecomunicaciones.

ATENCIÓN: para cumplir con los requisitos de Homologación para Europa, este dispositivo debe instalarse con un equipo informático con certificación CE que cumpla los límites de la Clase B. Todos los cables utilizados para conectar este dispositivo deben estar protegidos, conectados a tierra y no tener más de 3 m de longitud. El funcionamiento del dispositivo con equipos no certificados o cables incorrectos podría provocar interferencias a otros dispositivos o efectos no deseados al producto.

MODIFICACIÓN: los cambios o modificaciones no aprobados expresamente por Creative Technology Limited o una de sus empresas afiliadas podrían invalidar la garantía del usuario y los derechos de la garantía.

[NL] Europese naleving

Dit product voldoet aan de volgende voorschriften:

EMC-richtlijn 2004/108/EG.

RoHS-richtlijn 2011/65/EU.

Elektrische producten voor de Europese markt voldoen aan de Laagspanningsrichtlijn 2006/95/EG en EC and Verordening(en) voor uitvoering van Richtlijn 2009/125/EG.

Communicatie- of draadloze RF-producten voor de Europese markt voldoen aan de richtlijn R&TTE 1999/5/EG.

LET OP: Om te voldoen aan de Europese CE-norm, moet dit apparaat zijn geïnstalleerd in computerapparatuur die CE-gecertificeerd is voor de Klasse B-limieten. Alle kabels die worden gebruikt om dit apparaat aan te sluiten, moeten zijn afgeschermd en geaard, en mogen niet langer dan 3 meter zijn. Gebruik met niet-gecertificeerde computers of incorrecte kabels kan leiden tot interferentie van andere apparaten of ongewenste effecten op het product.

AANPASSING: Alle wijzigingen of modificaties die niet uitdrukkelijk zijn goedgekeurd door Creative Technology Limited of een van de gelieerde maatschappijen, kunnen ertoe leiden dat de rechten van de gebruiker met betrekking tot garantie en vrijwaring vervallen.

[PT] Conformidade Europeia

Este produto está em conformidade com a seguinte regulamentação:

Directiva EMC 2004/108/EC.

Directiva RoHS 2011/65/UE.

Os produtos com ligação à rede destinados ao mercado europeu estão em conformidade com a diretiva de baixa voltagem 2006/95/CE. Directiva de Implementação do(s) Regulamento(s) da Comissão 2009/125/CE.

Os produtos de comunicação/radiofrequência sem fios destinados ao mercado europeu estão em conformidade com a diretiva R&TTE 1999/5/CE.

ATENÇÃO: De modo a cumprir com os requisitos da marca CE Europeia, este dispositivo deve ser instalado com equipamento informático com certificação CE que cumpra com os limites de Classe B. Todos os cabos usados para ligar este dispositivo devem ser blindados, ligados à terra e não devem exceder os 3m de comprimento. O funcionamento com computadores não certificados ou cabos incorrectos pode resultar em interferências em outros dispositivos ou provocar efeitos indesejados no produto.

MODIFICAÇÃO: Quaisquer alterações ou modificações que não sejam expressamente aprovadas pela Creative Technology Limited ou por uma das suas afiliadas, pode anular a garantia do utilizador e os direitos inerentes à mesma.

[SV] Europeisk efterlevnad

Denna produkt uppfyller följande:

EMC-direktivet 2004/108/EC.

RoHS Direktivet 2011/65/EU.

Produkter för den europeiska marknaden som drivs via elnätet uppfyller Lågspänningsdirektivet 2006/95/EC och Kommissionens regleringsimplementeringsdirektiv 2009/125/EG.

Trådlösa kommunikations/RF-produkter för den europeiska marknaden uppfyller R&TTE-direktivet 1999/5/EC.

VARNING: För att uppfylla CE-kraven i Europa måste denna produkt installeras med CE-certifierad datorutrustning som uppfyller gränsvärdena för klass B. Alla kablar som används för anslutning av denna produkt måste vara avskärmade, jordade och får inte vara längre än 3 m. Användning med icke certifierade datorer eller felaktiga kablar kan leda till interferens på annan utrustning eller oönskade effekter på produkten.

Regulatory Information - 51 -

Regulatory Information - 52 -

MODIFIERING: Alla förändringar och modifieringar som inte är uttryckligen tillåtna av Creative Technology Limited eller något av dess filialföretag kan göra användarens garanti och garantirättigheter ogiltiga.

[NO] Europeisk samsvar

Dette produktet er i samsvar med følgende:

EMC-direktivet 2004/108/EC.

RoHS-Direktivet 2011/65/EU.

Elektriske produkter til det europeiske markedet er i samsvar med Lavspenningsdirektivet 2006/95/EC og Økodesigndirektivet 2009/125/EC.

Kommunikasjonj/RF trådløse produkter til det europeiske markedet er i samsvar med R&TTEdirektivet 1999/5/EC.

ADVARSEL: For å overholde det europeiske CE-kravet må denne enheten installeres med CEsertifisert datautstyr som tilfredsstiller klasse B-grensene. Alle kabler som kobles til enheten må være skjermet, jordet og ikke lenger enn 3 m i lengde. Bruk av ikke-sertifiserte datamaskiner eller feil kabler kan føre til forstyrrelse av andre enheter eller uønsket effekt på produktet.

MODIFIKASJON: Eventuelle endringer eller modifikasjoner som ikke uttrykkelig er godkjent av Creative Technology Limited eller et av dets tilknyttede selskaper, kan ugyldiggjøre garantien eller garantirettighetene.

[DK] Overholdelse af Europæiske regler og standarder

Dette produkt overholder følgende:

EMC-direktivet 2004/108/EC.

RoHS-Direktivet 2011/65/EU.

Produkter til det Europæiske marked, skal overholde Lavspændingsdirektivet 2006/95/EC og Kommissionens forordninger for implementering af direktivet 2009/125/EF.

Kommunikations- / RF-trådløse produkter til det Europæiske overholder R&TTE-direktivet 1999/5/EC.

ADVARSEL: For at overholde Europe CE-kravet, skal denne enheden installeres med CE-certificeret computerudstyr, der opfylder klasse B-grænserne. Alle kabler der anvendes til at tilslutte enheden skal være skærmede, jordforbundne og ikke længere end 3 m lange. Drift med ikke-certificerede computere og ukorrekte kabler kan medføre interferens for andre enheder eller uønskede effekter på produktet.

MODIFIKATION: Enhver ændring eller modifikation, der ikke er udtrykkeligt godkendt af Creative Technology Limited eller et associerede selskab, vil gøre brugerens garanti og garanterede rettigheder ugyldig.

[FI] Eurooppalainen yhdenmukaisuus

Tämä tuote täyttää seuraavat tuotemääritykset:

EMC-direktiivin 2004/108/EC.

RoHS-direktiivin 2011/65/EU.

Euroopan markkinoiden verkkovirtaa käyttävät tuotteet ovat matalajännittdirektiivin 2006/95/EY mukaisia. Euroopan parlamentin ja neuvoston ohjaava direktiivi 2009/125/EY.

Euroopan markkinoiden tietoliikenne- ja langattomat radiotaajuustuotteet noudattavat R&TTEdirektiiviä 1999/5/EY.

Regulatory Information - 53 -

2004/108/EGK sz., az elektromágneses összeférhetőségre. 2011/65/EU, RoHS.

Az Európa területére szánt hálózati termékek megfelelnek az alacsony feszültségre vonatkozó 2006/95/EC irányelvnek.

Az irányelvet 2009/125/EK végrehajtó bizottsági rendeletek.

Az Európa területére szánt, távközlési, illetve rádiófrekvenciás vezeték nélküli termékek megfelelnek a rádiós távközlő végberendezésekre vonatkozó 1999/5/EK irányelvnek.

FIGYELEM! Az európai CE követelmények teljesítéséhez ezt a készüléket a B kategóriájú értékeknek megfelelő, CE minősítésű számítógéppel együtt kell telepíteni. A készülék csatlakoztatására használt valamennyi kábelnek árnyékoltnak és földeltnek kell lennie, továbbá hosszúsága nem haladhatja meg a 3 métert. A nem hitelesített számítógéppel vagy helytelen kábellel való használat más készülékek zavarását vagy a termék nem kívánatos befolyásolását okozhatja.

MÓDOSÍTÁS: Minden módosítás vagy változtatás, amit kifejezetten nem hagyott jóvá a Creative Technology Limited vagy valamelyik leányvállalata, érvénytelenítheti a készülék garanciáját és felhasználó garanciális jogait.

[EL] Ευρωπαϊκή συμμόρφωση

Το παρόν προϊόν συμμορφώνεται με τα παρακάτω:

Οδηγία ΗΜΣ 2004/108/ΕΚ.

Οδηγία RoHS 2011/65/ΕΕ.

Τα προϊόντα που λειτουργούν με ρεύμα για την ευρωπαϊκή αγορά συμμορφώνονται με την Οδηγία περί χαμηλής τάσης 2006/95/ΕΚ και τους κανονισμούς της επιτροπής που υλοποιούν την οδηγία 2009/125/ΕΚ.

Τα σύρματα προϊόντων επικοινωνιών / RF για την ευρωπαϊκή αγορά συμμορφώνονται με την οδηγία R&TTE 1999/5/ΕΚ.

ΠΡΟΣΟΧΗ: Για τη συμμόρφωση με τις απαιτήσεις του ευρωπαϊκού CE, αυτή η συσκευή θα πρέπει να εγκατασταθεί σε εξοπλισμό υπολογιστή με πιστοποίηση CE ο οποίος πληροί τα όρια της κατηγορίας Β. Όλα τα καλώδια που χρησιμοποιούνται για τη σύνδεση της συσκευής θα πρέπει να είναι θωρακισμένα, γειωμένα και να μην υπερβαίνουν σε μήκος τα 3μ. Η λειτουργία με μη πιστοποιημένους υπολογιστές ή λάθος καλώδια μπορεί να οδηγήσει σε παρεμβολές με άλλες συσκευές ή ανεπιθύμητες επιδράσεις στο προϊόν.

ΤΡΟΠΟΠΟΙΗΣΗ: Οι όποιες αλλαγές ή τροποποιήσεις που δεν έχουν εγκριθεί ρητά από την Creative Technology Limited ή κάποιο από τις θυγατρικές της ενδέχεται να ακυρώσουν την εγγύηση του χρήστη και τα δικαιώματα που απορρέουν από αυτήν.

[LT] Europos Sąjungos atitiktis

Šis gaminys atitinka šiuos reikalavimus:

„Elektromagnetinės atitikties“ („EMC“) direktyva 2004/108/EC.

RoHS direktyva 2011/65/ES.

Produktai, kurie veikia maitinami iš elektros tinklo, skirti Europos rinkai, atitinka Žemos (tampos) direktyvą 2006/95/EB. Komisijos reglamentas(-ai) dėl Direktyvos 2009/125/EB įgyvendinimo.

Europos Sąjungos rinkai skirti ryšiu / radijo dažnių bevieliai gaminiai atitinka 1999/5/EB direktyvą „Dėl radijo ryšio įrenginių ir telekomunikacijų galinių įrenginių bei apibūpino jų atitikties pripažinimo“.

ATSARGIAI: Tam, kad šis prietaisas atitiktų Europos Sąjungos „CE“ reikalavimus, jis turi būti įdiegtas į „CE“ sertifikuotą kompiuterinę įrangą, atitinkančią „B“ klasės ribas. Visi su šiuo prietaisu naudojami laidai turi būti ekranuoti, įžeminti ir neviršyti 3 m ilgio. Nesertifikuoti kompiuterių ar netinkamų laidų

Regulatory Information - 55 -

VAROITUS: Jotta tämä laite noudattaisi Euroopan CE-vaatimuksia , tämä laite on asennettava CESertifioitun tietokoneeseen, joka noudattaa Luokan B rajoituksia. Kalkki tämän laitteen liittämiseen käytetyt kaapelit tulee suojata ja maadoittaa eivätkä ne saa olla 3 m pidempiä. Luokan rajoituksia noudattamattoman tietokoneen tai väärinlaisten kaapeleiden käyttäminen voi aiheuttaa häiriöitä muihin laitteisiin tai häiritä itse laitteen toimintaa.

MUOKKAUKSET: Muutokset tai muokkaukset, joita Creative Technology Limited tai sen tytäryhtiöt eivät nimenomaisesti ole hyväksyneet, voivat mitätöidä tuotteelle annettun takuun.

[CZ] Evropská shoda

Tento výrobek splňuje následující směrnice:

Směrnice EMC 2004/108/EC.

Směrnice RoHS 2011/65/EU.

Výrobky napájené z elektrické zásuvky pro evropský trh splňují směrnici o nízkém napětí 2006/95/EC a směrnici komise 2009/125/EC o zavadění předpisů.

Komunikační / vysokofrekvenční bezdrátové výrobky pro evropský trh splňují směrnici R&TTE 1999/5/EC.

UPOZORNĚNÍ: Aby toto zařízení splňovalo evropský požadavek CE, musí být nainstalováno s počítačovým vybavením s certifikátem CE, které splňuje limity pro zařízení třídy B. Veškeré kabely používané pro připojení tohoto zařízení musí být stíněné, uzemněné a nesmí být delší než 3 metry. Při používání s necertifikovanými počítači nebo nesprávnými kabely může dojít k rušení jiných zařízení nebo k nežádoucím vlivům na produkt.

ÚPRAVY: Jakékoli změny nebo úpravy, které nebyly vysloveně schváleny společností Creative Technology Limited nebo některou z jejích dceřiných společností, mohou způsobit propadnutí záruky uživatele a zárukních práv.

[PL] Zgodność z przepisami europejskimi

Urządzenie jest zgodne z

dyrektywą EMC 2004/108/EC.

Dyrektywą RoHS 2011/65/EU.

Urządzenia zasilane z sieci elektrycznej przeznaczone na rynek europejski muszą być zgodne z dyrektywą dotyczącą urządzeń niskonapięciowych 2006/95/EC oraz z dyrektywą wdrażającą komisji regulacyjnej 2009/125/WE.

Urządzenia komunikacyjne / bezprzewodowe wykorzystujące transmisję radiową przeznaczone na rynek europejski spełniają warunki dyrektywy RTTE 1999/5/EC.

UWAGA: Aby uzyskać zgodność z wymogami europejskiej normy CE urządzenie musi być zainstalowane wraz ze sprzętem komputerowym mającym certyfikat CE z ograniczeniami klasy B. Wszystkie przewody używane do podłączania niniejszego urządzenia muszą być ekranowane, uziemione i nie dłuższe niż 3 metry. Użytkowanie z komputerami nie posiadającymi certyfikatów lub wykorzystanie niewłaściwych przewodów może powodować zakłócenia pracy innych urządzeń lub opisywanego urządzenia.

MODYFIKACJE: Dokonanie jakichkolwiek zmian lub modyfikacji, na które firma Creative Technology Limited lub spółki z nią stowarzyszone nie udzielają wyraźnej zgody, może doprowadzić do unieważnienia praw gwarancji i rekowej użytkownika.

[HU] Európai megfelelés

Ez a termék megfelel a következőknek:

naudojimas gali tapti trikdžių kitiems prietaisams arba nepageidaujamų šio gaminio veikimo pasekmių priežastimi.

MODYFIKAVIMAS: Bet kokie pakeitimai ar modifikavimai neturint aiškiai patvirtinto „Creative Technology Limited“ ar vienos iš su ja susijusių bendrovių leidimo gali panaikinti vartotojo garantiją ir garantijos teises.

[SK] Dodržiavanie predpisov Európskej únie

Tento výrobok spĺňa nasledujúce normy:

Smernica EMC 2004/108/ES.

Smernica RoHS 2011/65/EÚ.

Výrobky napájané zo siete určené na európsky trh sú v súlade so smernicou o harmonizácii právnych predpisov členských štátov týkajúcich sa elektrického zariadenia určeného na používanie v rámci určitých limitov napätia 2006/95/ES a s nariadeniami Komisie, ktorými sa vykonáva smernica 2009/125/ES.

Bezdrôtové komunikačné/RF výrobky určené na európsky trh sú v súlade so smernicou R&TTE 1999/5/ES.

VAROVANIE: Toto zariadenie musí byť nainštalované s počítačovým zariadením s certifikáciou CE, ktoré spĺňa limity triedy B, aby bolo v súlade s európskymi požiadavkami CE. Všetky káble použité na pripojenie tohto zariadenia musia byť biene, uzemnené a nie dlhšie ako 3 m. Prevádzka pomocou necertifikovaných počítačov alebo nesprávnych káblov môže mať za následok rušenie iných zariadení alebo nežiaduce účinky na výrobok.

ÚPRAVY: Akékoľvek zmeny alebo úpravy, ktoré neboli výslovne odsúhlasené spoločnosťou Creative Technology Limited alebo jednou z jej sesterských spoločností, môžu zrušiť platnosť záruky a zárukých práv používateľa.

[RU] Соответствие европейским нормам

Данное издание соответствует следующим стандартам:

EMC Директива 2004/108/EC.

RoHS директива 2011/65/EU.

Продукция с питанием от сети, поставляемая на европейский рынок, соответствует Директиве по низковольтному оборудованию 2006/95/EC и Имплементирующей директиве постановления (- и) комиссии 2009/125/EC.

Коммуникационное/радио- беспроводное оборудование, поставляемое на европейский рынок, соответствует Директиве по оконечному радио- и телекоммуникационному оборудованию 1999/5/EC.

ВНИМАНИЕ! Для обеспечения соответствия европейским требованиям CE, это устройство должно устанавливаться с компьютерным оборудованием, сертифицированным по стандарту CE и удовлетворяющим нормам класса B. Все кабели, используемые для подключения данного устройства, должны быть экранированы, заземлены и иметь длину не более 3 м. Работа с несертифицированными компьютерами или неподходящими кабелями может привести к возникновению помех другим устройствам или негативному влиянию на работу самого изделия.

ИЗМЕНЕНИЯ КОНСТРУКЦИИ! Любые изменения конструкции, на которые не было получено прямое разрешение компании Creative Technology Limited или ее дочерней компании, может привести к аннулиации гарантии и связанных с ней прав.

[TR] Avrupa Uyumu

Bu ürün aşağıdakilere uygundur:

Regulatory Information - 54 -



Regulatory Information - 56 -

2004/108/EC EMC (Elektromanyetik Uyumluluk) Yönetmeliği.

2011/65/EU RoHS (Tehlikeli Maddelerin Kısıtlanması) Yönetmeliği

Avrupa piyasasına yönelik, elektrik şebekesi tarafından çalıştırılan ürünler 2006/95/EC Alçak Gerilim Yönetmeliği (LVD) ve 2009/125/EC Enerji ile İlgili Ürünlerin Çevreye Duyarlı Tasarımına İlişkin Yönetmeliğe uygundur.

Avrupa piyasasına yönelik İletişim / RF kablosuz ürünleri Yönetmelik R&TTE 1999/5/EC ile uyumludur.

DİKKAT: Avrupa CE gereksinimleriyle uyumlu olması için bu cihazın, B Sınıfı sınırlarına uygun olan CE sertifikalı bilgisayar donanımları ile birlikte kurulması gerekir. Bu cihazı bağlamak için kullanılan tüm kabloların koruyuculu ve topraklanmış olması ve 3 metreden uzun olmaması gerekir. Sertifikalı olmayan bilgisayarlarla veya yanlış kablolarla birlikte kullanılması, diğer cihazların düzgün çalışmasına veya üründe istenmeyen etkiler görülmesine neden olabilir.

DEĞİŞİKLİKLER: Creative Technology Limited veya bağlı şirketlerinden biri tarafından açıkça onaylanmamış tüm değişiklikler kullanıcının garanti ve teminat haklarını geçersiz kılabilir.

Notice for Korea

B급 기기

(가정용 방송통신기자재)

이 기기는 가정용 (B급) 전자파적합기기로서 주로 가정에서 사용하는 것을 목적으로 하며, 모든 지역에서 사용할 수 있습니다.

Notice for Singapore

Complies with
IDA Standards
DB00148

Ukraine RoHS Statement

Обладнання відповідає вимогам Технічного регламенту щодо обмеження використання деяких небезпечних речовин в електричному та електронному обладнанні, затвердженого постановою Кабінету Міністрів України від 3 грудня 2008 № 1057

Vietnam RoHS Statement

This product is in compliance with Circular 30/2011/TTBCT of the Ministry of Trade of the Socialist Republic of Vietnam ("Circular"), it does not contain the following substances in concentration greater than the Maximum Limit value as specified in the Circular.

Substance	Maximum Limit (ppm) ^{1, 2}
• lead	1000
• mercury	1000
• cadmium	100
• hexavalent chromium	1000
• polybrominated biphenyls (PBB)	1000
• polybrominated diphenyl ethers (PBDE)	1000

¹ Maximum Limit does not apply to applications exempted from the Circular.

² Maximum Limit refers to concentration by weight in homogeneous materials.

Regulatory Information - 57 -

Regulatory Information - 58 -

License and Copyright

Information in this document is subject to change without notice and does not represent a commitment on the part of Creative Technology Ltd. No part of this manual may be reproduced or transmitted in any form or by any means, electronic or mechanical, including photocopying and recording, for any purpose without the written permission of Creative Technology Ltd.

Copyright © 2014 Creative Technology Ltd. All rights reserved. Creative, the Creative logo, Sound Blaster, the Sound Blaster logo, Creative ALchemy, CrystalVoice, SBX Pro Studio and the SBX logo are trademarks or registered trademarks of Creative Technology Ltd. in the United States and/or other countries. Manufactured under the license from Dolby Laboratories. Dolby and the double-D symbol are trademarks of Dolby Laboratories. Intel and Pentium are registered trademarks of Intel Corporation. AMD and AMD Athlon are trademarks of Advanced Micro Devices, Inc. Microsoft, Windows Vista, Windows and the Windows logo are trademarks or registered trademarks of Microsoft Corporation. iPhone, iPad, Mac OS®, OS X® and GarageBand are trademarks of Apple Inc., registered in the U.S. and other countries. Android is a trademark of Google Inc. The Bluetooth® word mark and logos are registered trademarks owned by Bluetooth SIG, Inc. and any use of such marks by Creative Technology Ltd is under license. Other trademarks and trade names are those of their respective owners. All specifications are subject to change without prior notice. Use of this product is subject to a limited hardware warranty. Actual contents may differ slightly from those pictured. The software included in this packaging may not be used separately from the hardware. Before using the software, you must agree to be bound by the terms and conditions of the end user license agreement.

Version 1.0

June 2014