

CREATIVE®

**X-Fi®**  
**SONIC CARRIER™**



**THE AUDIO OF TOMORROW**

**USER'S MANUAL**

Creative X-Fi Sonic Carrier (Model MF8235)

For the latest information, visit: [www.creative.com/support/soniccarrier](http://www.creative.com/support/soniccarrier)

# Contents

## Package Contents

- Main unit
- Subwoofer
- Insert Batteries to your Remote Control (AAA Battery X 2)

page **4**

## Wall Mount Your Sonic Carrier

Discover the core elements that make Sound BlasterX H5 Tournament Edition the gaming headset for professional gamers.

page **6**

## Connecting Electrical Power

page **8**

## Setting Up the Wireless Subwoofer Connection

page **9**

## Connect Your Sonic Carrier

page **10**

## Overview

- Main unit
- Subwoofer
- Remote Control

page **14**

## Product Specification

page **18**

## Main Unit

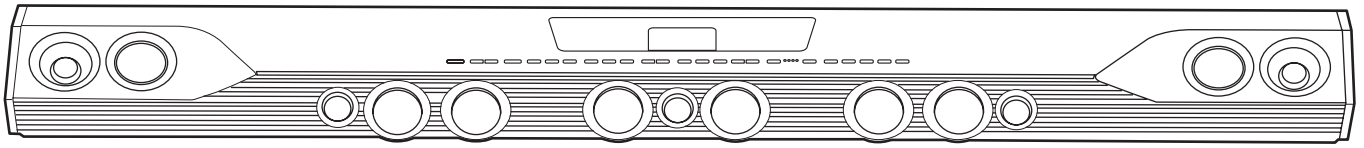

## Accessories box



IR remote control



AAA Battery x 2 for IR remote control

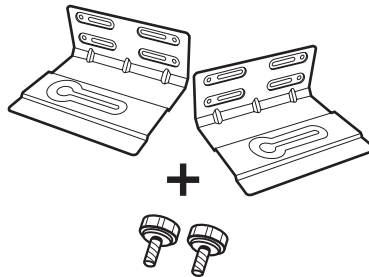

Wall mount brackets + thumbscrew



Driver décor rings x 8

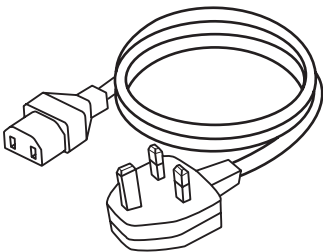

Power cable

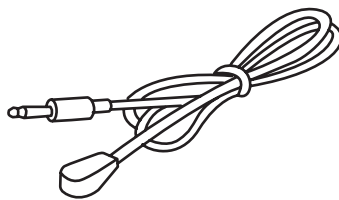

IR Transmitter

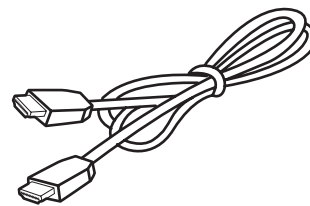

HDMI Cable



- Warranty / Tech Support booklet
- Safety and regulatory leaflets
- User Manual

# Setup App

XXXXXXXXXX

1. XXXXXXXXXXXX

## Insert Batteries to your Remote Control (AAA Battery X 2)

1. Slide the battery cover in the direction of the arrow until it is completely removed.
2. Insert 2 AAA batteries (1.5V) in the correct +/- polarity.
3. Slide the battery cover back into position.

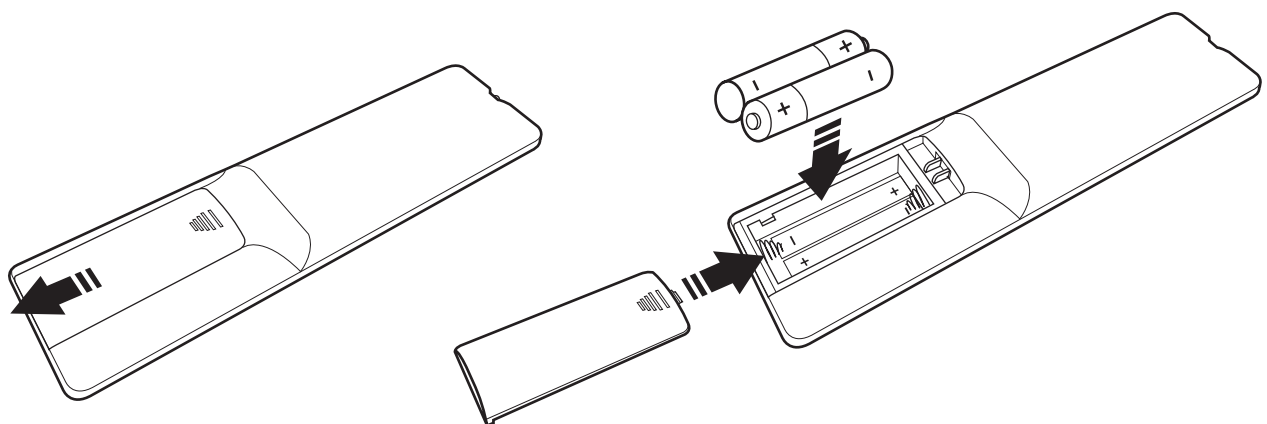

## Setup Recommendation

The Sonic Carrier main unit is designed to be placed on top of a console or wall mounted. For optimum performance, please observe the setup recommendation below.

1. In order to reproduce an immersive sound experience, the Sonic Carrier main unit radiates sound from the front, top and sides. Ensuring that these sound waves are not obstructed by objects placed in their path would yield the best sound experience. Do not place your Sonic Carrier within an enclosed fixture (Cabinet, Shelving unit, etc.), and make sure nothing is obstructing the sides. The top firing speakers needs to have a clear line of sight to the ceiling as well.
2. Locate the Sonic Carrier at least 10cm away from the bottom of your TV, to avoid obstructing the top firing speakers
3. For the best listening experience, the listening position should be at least 3ft away from the Sonic Carrier
4. The subwoofer unit produces non-directional sound and thus could be placed at your convenience around the room. For optimum results, it would be best to locate the subwoofer equidistant to the main unit when measured from the listening position, and to keep the subwoofer within 3M of the main unit.
5. The subwoofer is equipped with a pair of ports that augments the sound output of the dual subwoofer drivers at the lowest frequencies. A distance of 10cm between the rear of the subwoofer enclosure and the adjacent wall has to be maintained in order to avoid turbulence or air chuffing noises.
6. Room acoustics has a major influence on sound quality. The ear is particularly troubled by standing waves and echoes which can be identified by moving around your room and loudly clapping your hands. Parallel surfaces such as opposite walls, floor and ceiling encourage and sustain these problems. However, rearranging curtains, thick carpets, rugs, furniture and bookcases can make a dramatic improvement as the sound waves are partially absorbed and diffused. As far as possible, the Sonic Carrier main unit should also be setup such as to maintain symmetry in the room, with equal distance from the main unit to the left and right wall.

## Care for your Sonic Carrier

### Cabinet

Your Sonic Carrier is finely crafted to last a lifetime from select metal alloys, engineering polymers; and should be treated as you would furniture with similar materials and finishes. Dust lightly with a soft lint-free cloth, avoiding abrasives and spirit based cleaners. If necessary, wipe carefully with a cloth slightly dampened with glass cleaner to remove stubborn soil and marks.

### Grilles

The acoustically transparent fabric midrange driver grilles help protect the driver units, and could be left in place during listening with negligible acoustic effect. These could be taken off and cleaned using a lint brush. Should you choose to clean the grilles in place, be careful not to press in and deform the drivers under the grille.

### Drivers

Avoid touching the speaker diaphragms, particularly tweeters. The surface of the midrange driver could be dusted very carefully with a soft dry brush.

### General care information

Avoid damp, direct sunlight and temperature extremes. The ventilation and ports should not be impeded by covering the ventilation openings with items, such as newspapers, table-cloths, curtains, etc. No naked flame sources, such as lighted candles, should be placed on the apparatus

# Wall Mounting The Main Unit

## Preparation Materials



Warning! Improper installation could lead to damage of the wall and to equipment, and might lead to injury. The following information does not constitute a complete set of wall mounting instruction, and are provided for use by qualified installers only.

### Concrete Wall



M5 Screw  
x8



Lock Washer  
x8



Plain Washer  
x8



Screw Driver



Hammer

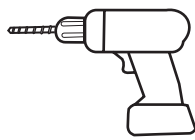

Hand Drill

### Hollow & Drywall

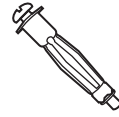

Cavity Anchor  
x8



Lock Washer  
x8



Plain Washer  
x8



Screw Driver



Hammer

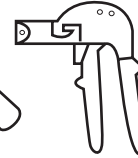

Cavity Anchor  
Application

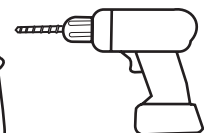

Hand Drill

\* Screw and wall plugs are not supplied for mounting the unit. We recommended the Hilti (HUD-16 x 30) for the mounting.

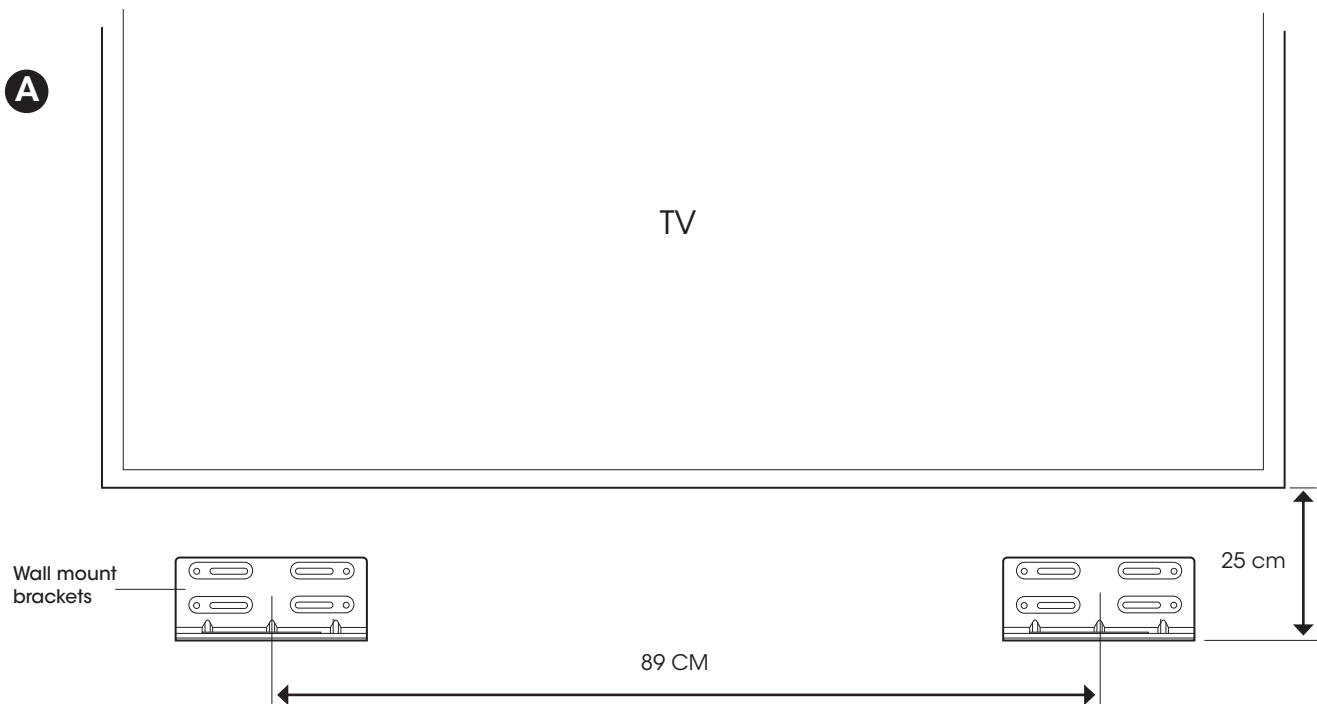

# Wall Mounting The Main Unit

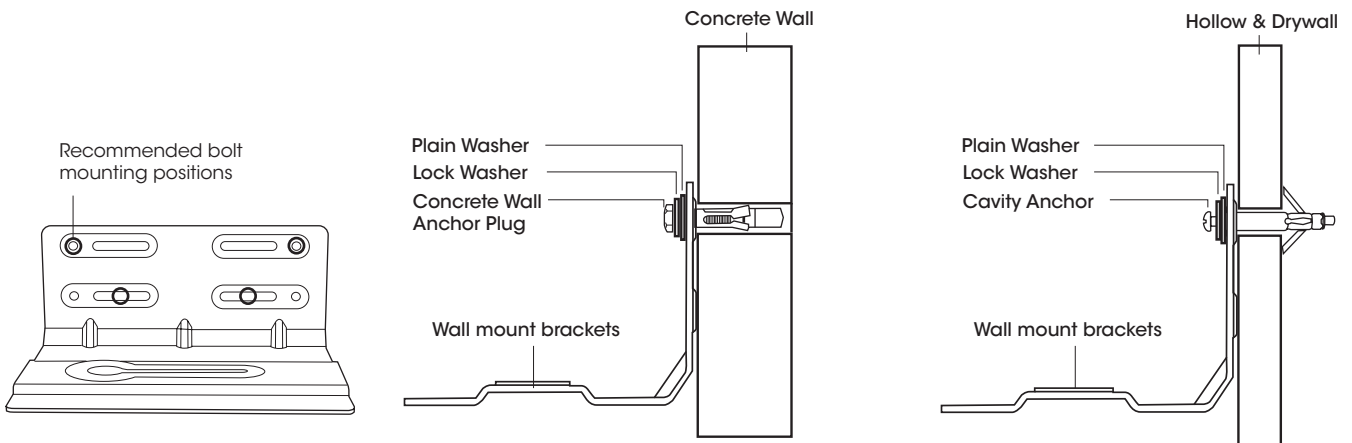

- B** Determine the mounting position of the Sonic Carrier main unit, ensuring that the position is properly centered relative to the TV and leveled horizontally. Note the recommended bolt locations, mark out and drill accordingly. Please ensure that the wall is able to bear the weight of the sonic carrier with adequate safety margins before proceeding. Please also note the location of buried pipes, conduits or cabling within the wall before drilling.

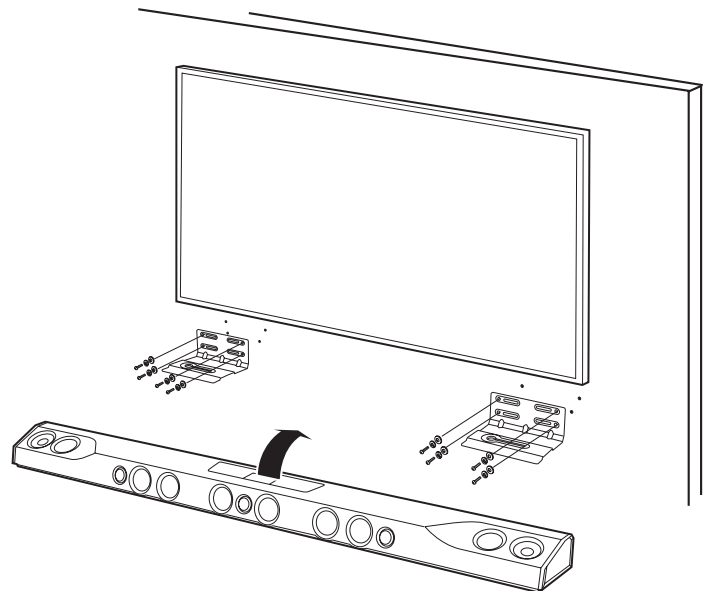

- C** Place and center the sonic carrier main unit on the wall mount brackets and attach the thumbscrews.

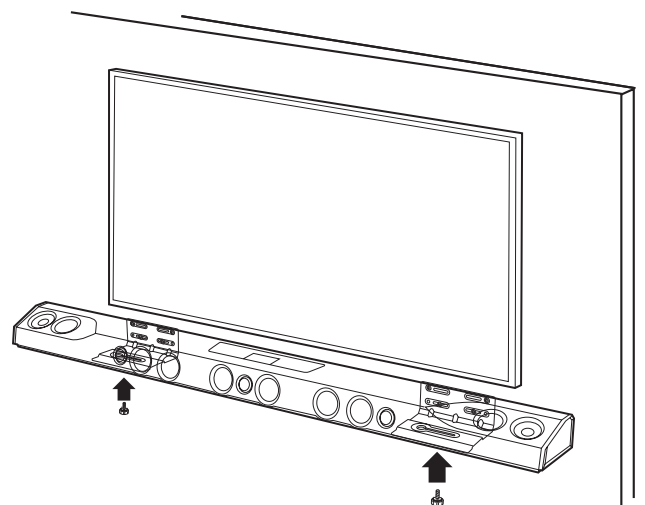

# Connecting Electrical Power

Connect the power cords to the main unit and subwoofers, socket location are located at the back of the units and are marked below. Connect power cords to the mains socket.

For more information about the power supply and power consumption, refer to the label attached to the product.  
(Main Unit : Bottom panel, Subwoofer : Rear panel)

## Main Unit

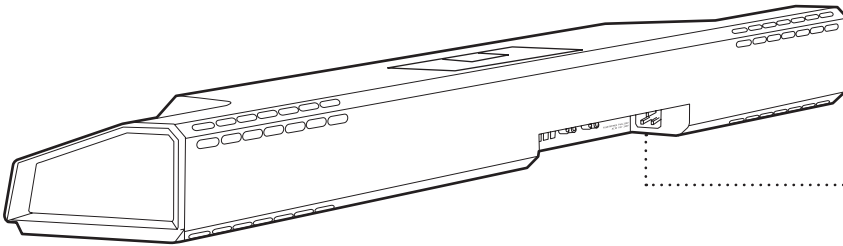
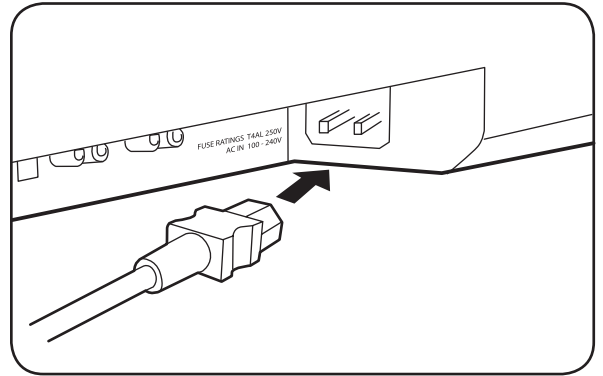

## Subwoofer

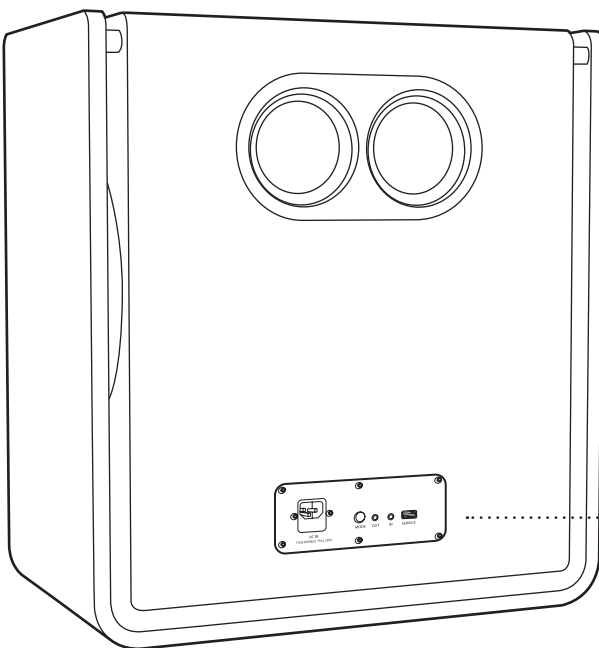
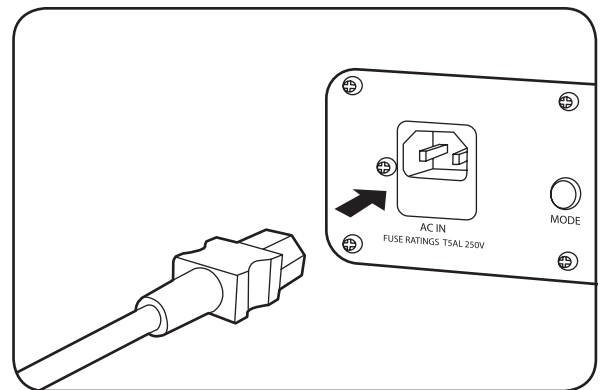



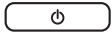

# Setting Up the Wireless Subwoofer Connection

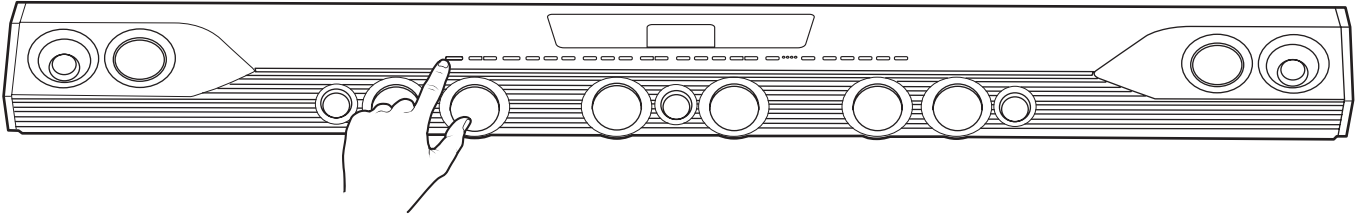
1. Ensure the Main unit and Subwoofer are placed within 3 metre for the setup process.
2. Ensure mains power is connected and switched on.
3. Power on the Main unit by pressing the power (  ) button. The boot up process may take around a minute.

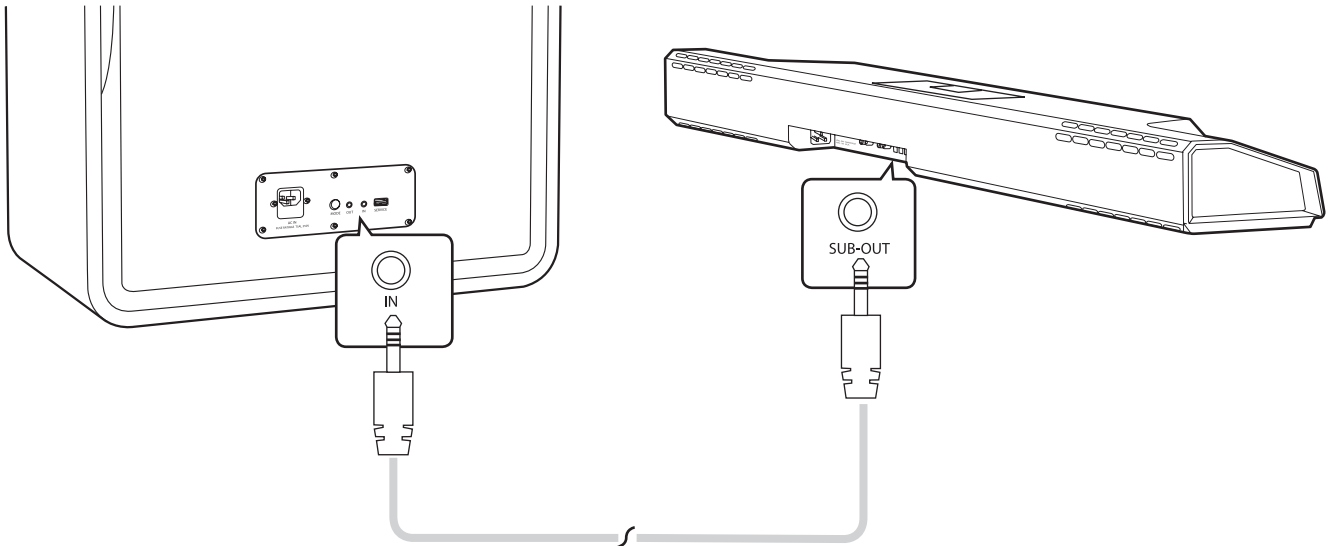

4. Connect the link cable (bundled with the subwoofer) between the main unit and the subwoofer. On the Main unit, the cable should be plugged into the Sub-Out connector. On the Subwoofer, the other end of the cable should be plugged into the In connector.



5. Press and hold the "  " button until the main display shows a "Waiting for subwoofer connection" message is shown. Upon successful setup, a message indicating "Subwoofer Connected" would be displayed.

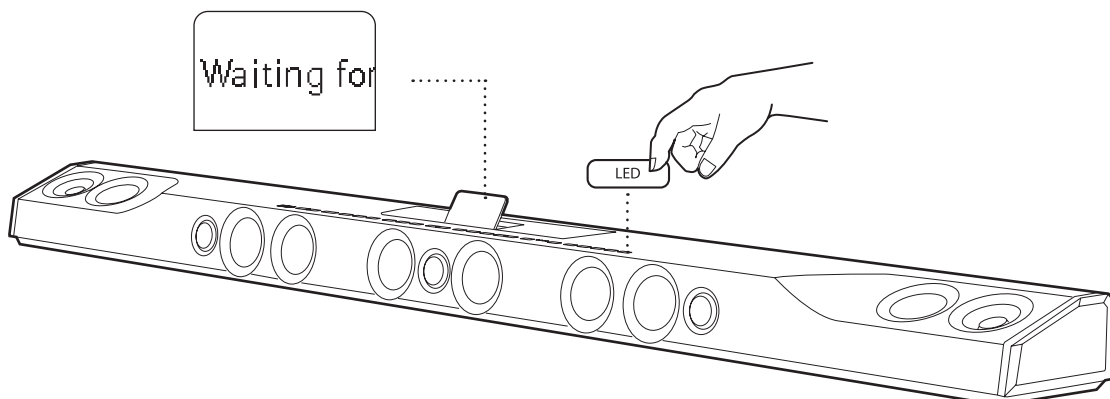

# Connecting Your Sonic Carrier

## Connecting Sonic Carrier to your TV

1. Connect the HDMI cable as shown in the illustration below
2. When TV sound is present, it is output automatically. On Certain TV sets, it might be necessary to press and hold the "HDMI" button on the remote control to enable TV sound output from the Sonic Carrier.

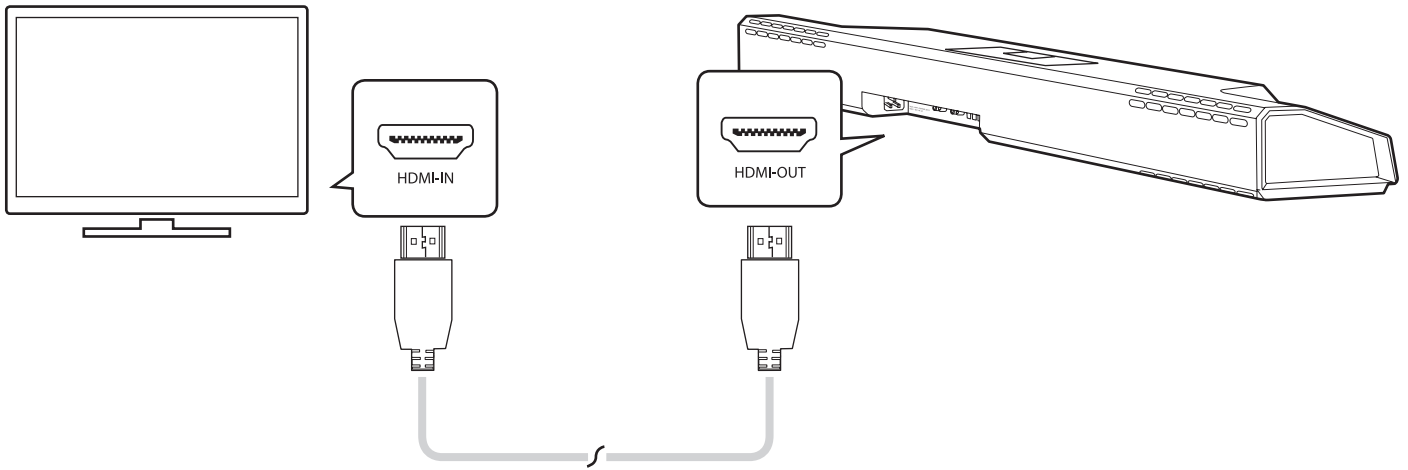

## IR Transmitter for TV

3. If you are placing the Sonic Carrier on a console, and it is blocking the IR remote control sensor of the TV, please install the bundled IR transmitter as shown. The transmitter should face the IR remote control sensor of the TV set. Please note that the IR transmitter requires the Sonic Carrier to be powered On or on Standby mode to work. Do not disconnect the Sonic Carrier from mains power.

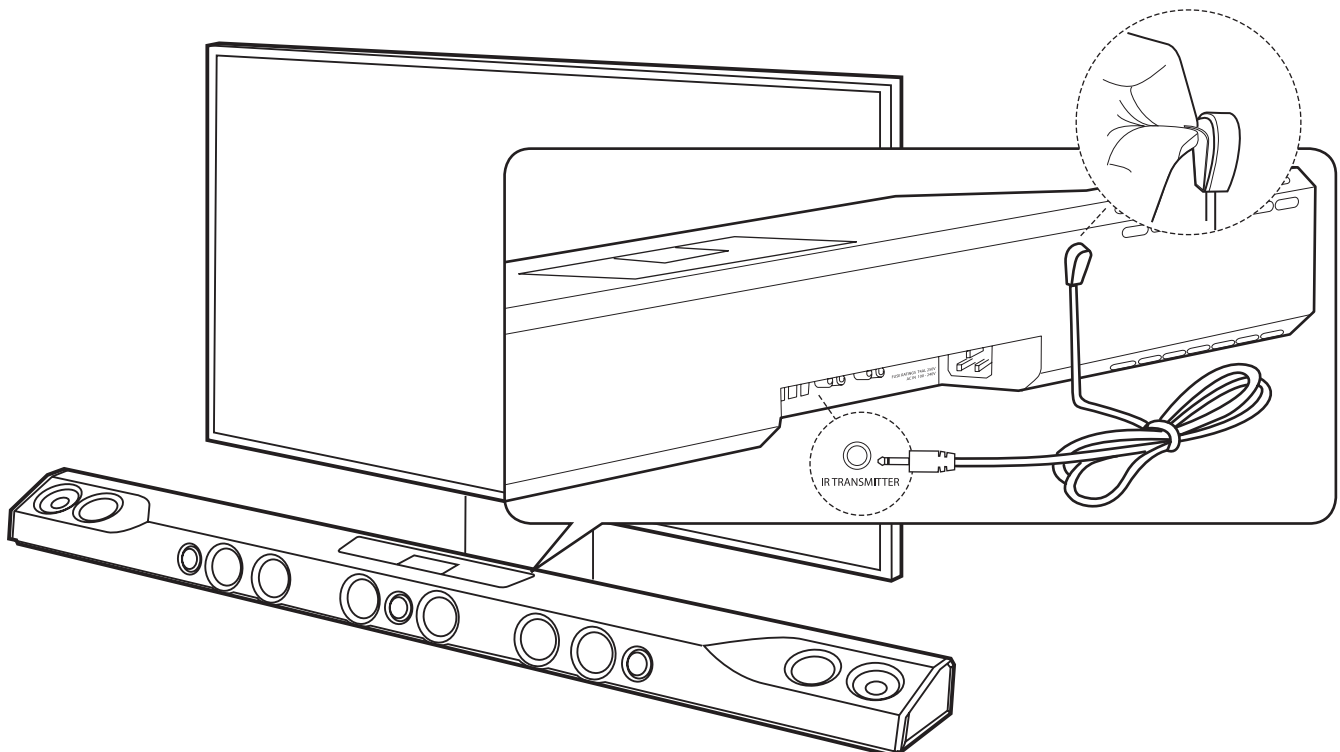

## Connecting external devices

The sonic carrier is equipped with a wide range of connectivity options. The following connection map illustrates the possibilities of connection, cable type needed, as well as the corresponding

### 1. HDMI Connection

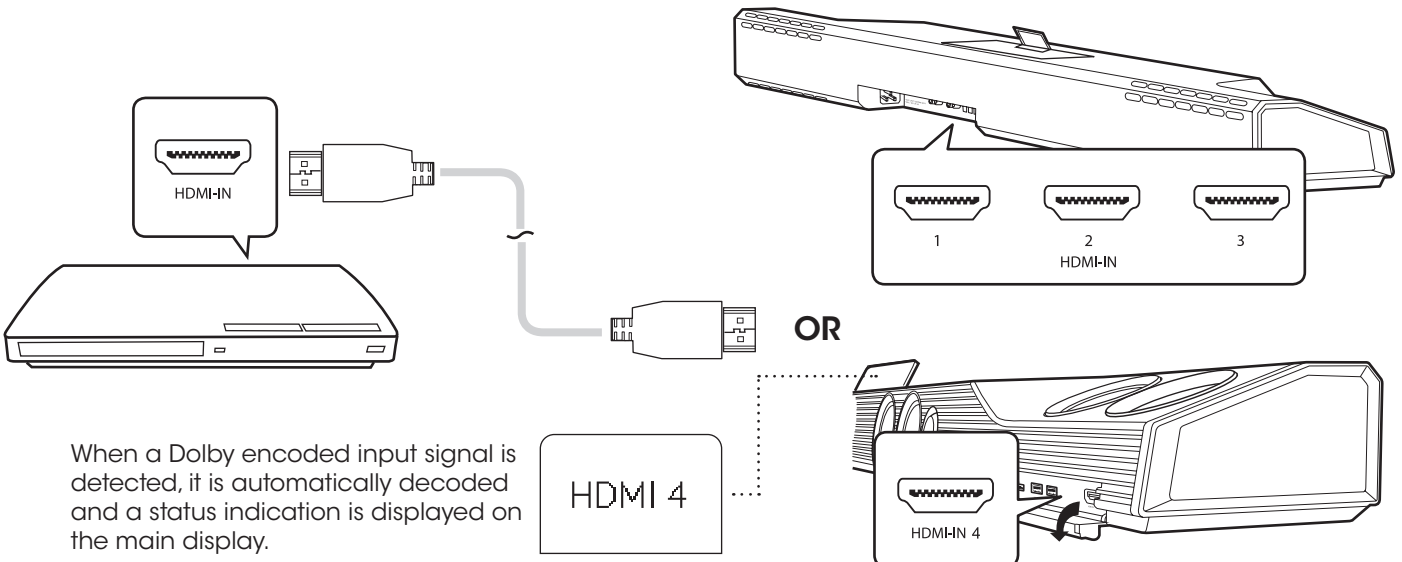

### 2. Optical Connection

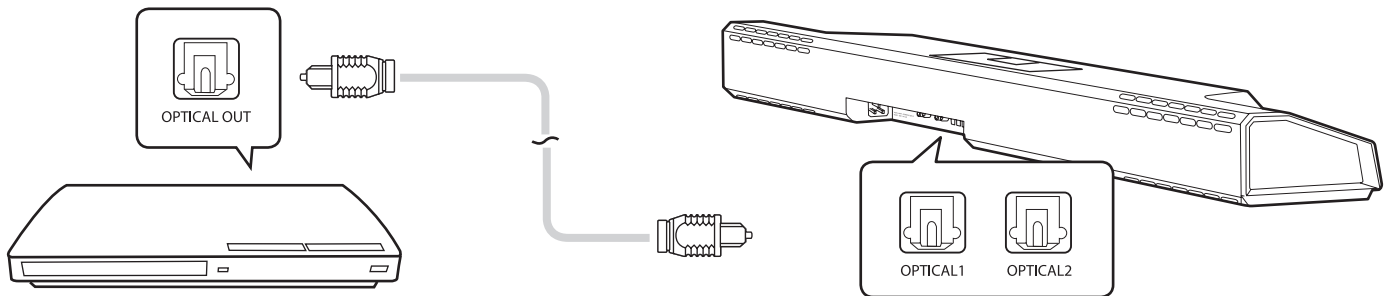

### 3. USB Connection

Front and Rear USB ports could be used to connect to USB flash drives or USB Hard disk drives.

The USB port labeled "Power" does not support data transfer, but could be used to provide power (Maximum: 5V 2A) to devices such as TV sticks.

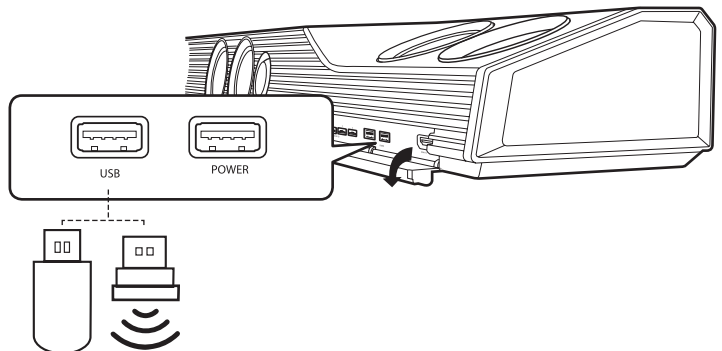

# Connecting Your Sonic Carrier

## 4. Bluetooth Connection

Press the "BT" button on the remote control, or the "BLUETOOTH" button on the main unit to switch to Bluetooth input. Hold the main unit's "Bluetooth" button till the display indicates BT Pairing to pair with your Bluetooth device.

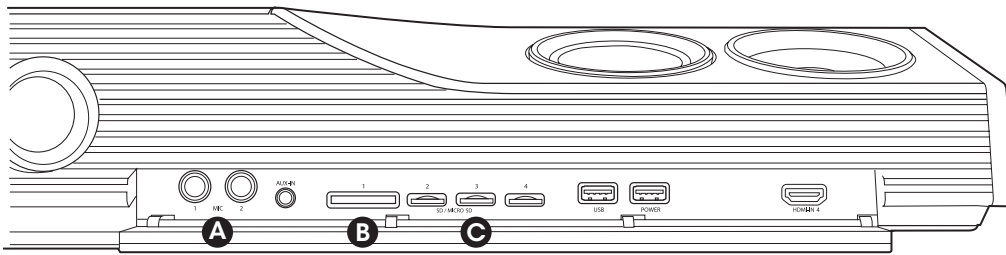
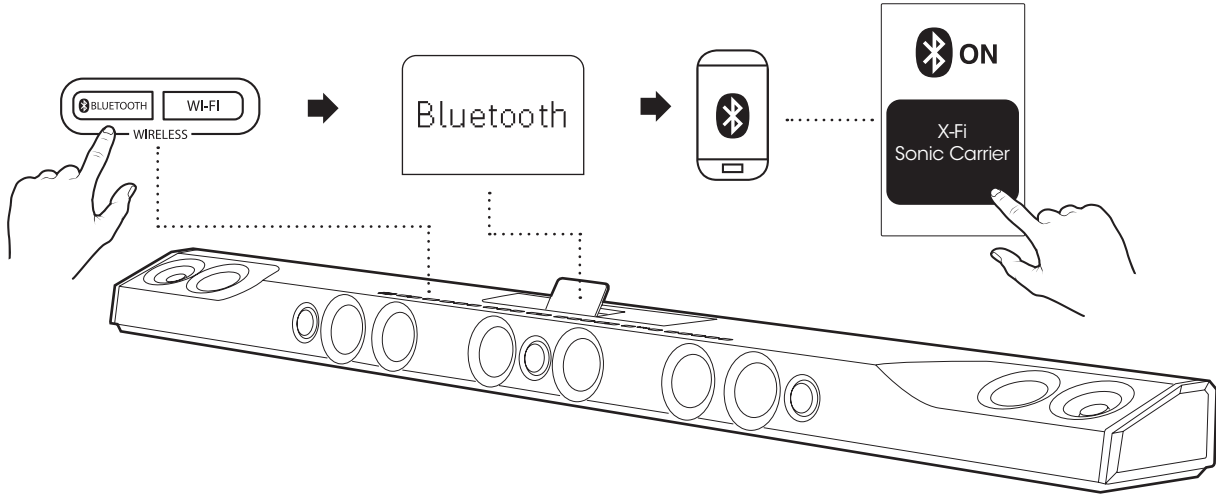

## 5. Microphone Connections

- A** A pair of 1/4" microphone inputs (Mic In 1, 2) is also located on the front panel, and supports most cardioid type dynamic microphones.

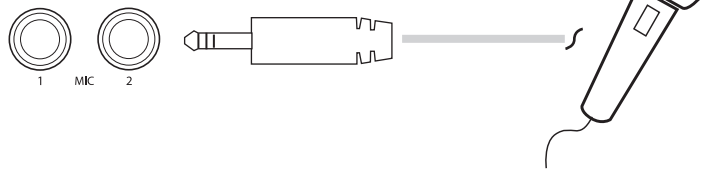

## 6. SD Cards

- B** 1 SD and 3 Micro-SD card slots are located at the front of the main unit. Only the selected card would be readable by the Android video engine.

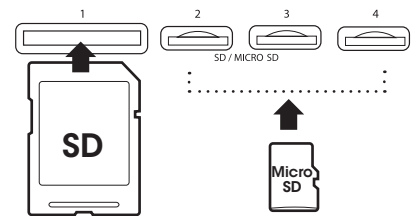

## 7. Analog Connections

- C** A 3.5mm stereo input (Aux-In) is located on the front panel for easy access.



## Connecting to your WiFi network

1. Ensure the sonic carrier is turned on and connected to your TV
2. Press "Home" to display the android video engine home screen
3. Select (Gear icon) from the top right corner of the home screen using the cursor and OK keys of the remote control
4. Select (Wi-Fi)
5. select the desired Wi-Fi network to connect to, enter the password and click on "Connect"

### Wi-Fi audio and Video

After the Wi-Fi network has been set up, select "Wi-Fi" to enjoy high quality audio over DLNA or to use Spotify Connect, or select "Home" to access the Android Video Engine.

How to use Connect (...insert from the spotify connect marketing requirements)

## Video Tutorials

Hit the "Home" button on the remote control to access a series of video tutorials, with step-by-step instructions on how to best use the Sonic Carrier.

# Overview

## Main unit



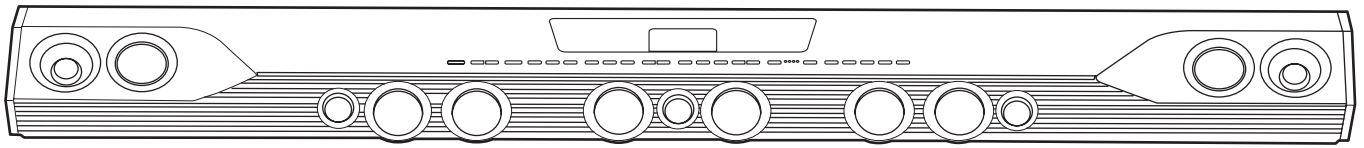



## Top Panel

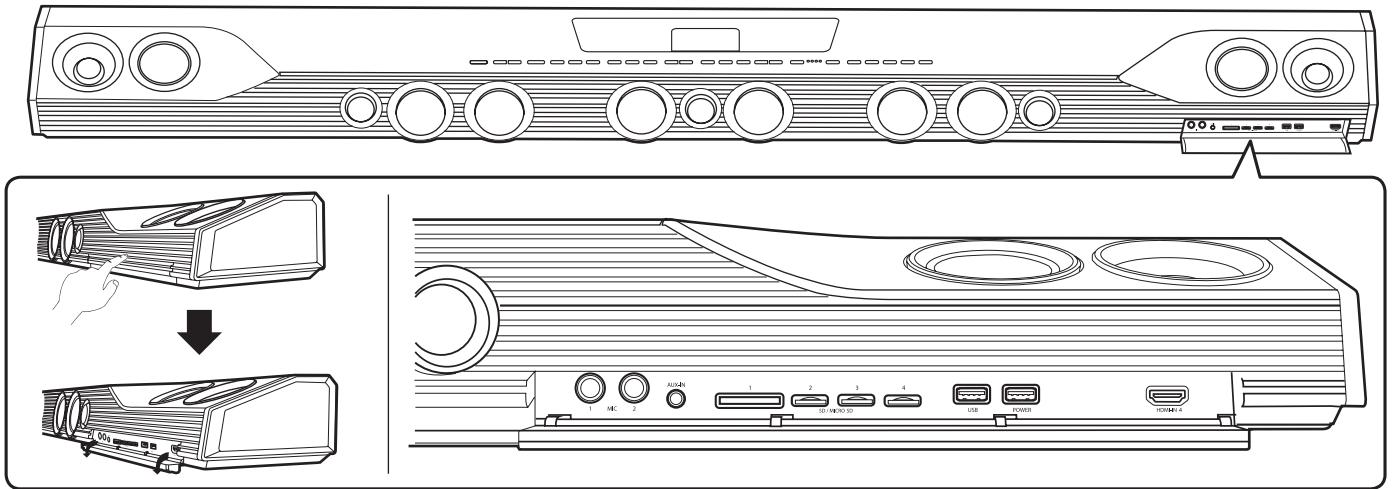

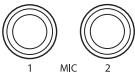
Button	Action
Power	Turn On/Off main power
Volume Control -	Volume Down Press-Hold to mute.
Volume Control +	Volume Up Press and Hold to volume up quickly.
X-Fi	Turns on and off X-Fi SuperWide processing
Previous	Previous track.
Play/Pause	Toggles between play and pause.
Next	Next track.
A/D	Custom buttons that can be assigned to web services. Short press to trigger A, Press and Hold to trigger D.
B/E	Custom buttons that can be assigned to web services. Short press to trigger B, Press and Hold to trigger E.
C/F	Custom buttons that can be assigned to web services. Short press to trigger C, Press and Hold to trigger F.
Bluetooth	Switch to Bluetooth mode Press and Hold to go to <i>Bluetooth</i> Pairing
WIFI	Switch to Wifi mode
Home	Switch to Android OTT mode, and show home screen.
Out	Switch between available outputs like Speaker, Output or BT headphone
Mic	Switch between available microphone adjustment mode, Mic Vol, Mic Key, Mic Reverb.
Mic Control -	Decrease the vol, key or reverb for both the microphones, depending on the microphone adjustment mode. In volume mode, press and hold button to mute.
Mic Control +	Increase the vol, key or reverb for both the microphones, depending on the microphone adjustment mode.
HDMI	Switch between available HDMI Inputs. LED 1-4 will be lighted to indicate input source.
SD	Switch between available SD Inputs. LED 1-4 will be lighted to indicate input source.
USB	Switch between available USB inputs.
OPT	Switch between available Optical Inputs
L-In	Switch to Line Input.
Aux	Switch to Aux Input.
LED	Cycle LED patterns on Subwoofer. Press and Hold to enter subwoofer pairing mode.

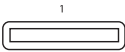
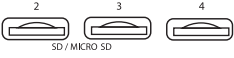
## Front Panel







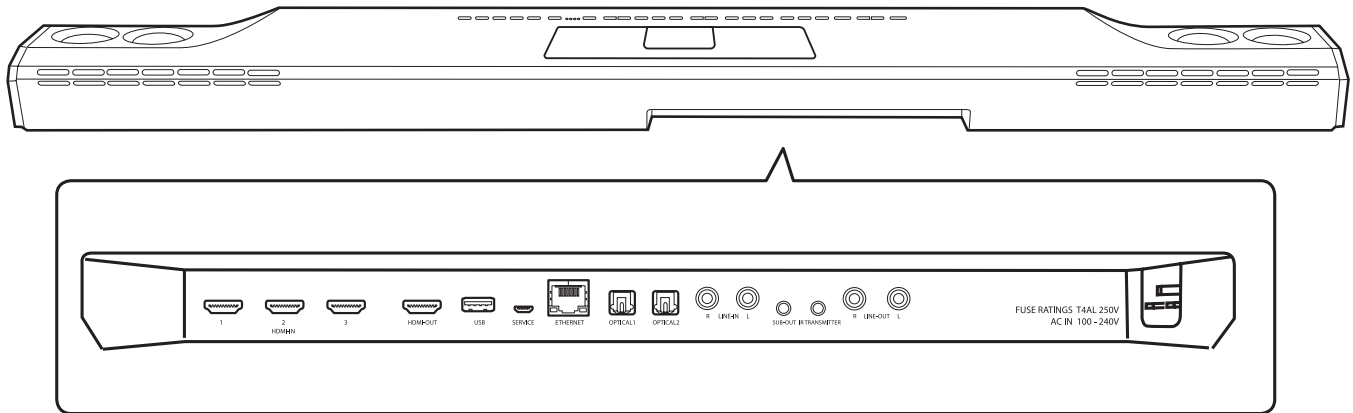

Connector	Description
	Microphone Input (1/4")
	Auxiliary Input (3.5mm 4-pole)
	SD Card Slot
	microSD Card Slots
	USB Host (external hard disk, flash drive), Keyboard/mouse dongle
	USB Power (5V 2A)
	HDMI 2.0a Input

# Overview

## Rear Panel

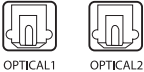
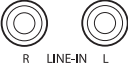
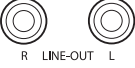

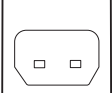
Connector	Description
 <p>1 2 3 HDMI-IN</p>	HDMI 2.0a Inputs
 <p>HDMI-OUT</p>	HDMI 2.0a Outputs
 <p>USB</p>	USB Host (external HDD, flash drive) , Keyboard/mouse dongle
 <p>SERVICE</p>	Service Port. No user accessible features.
 <p>ETHERNET</p>	Gigabit Ethernet
 <p>OPTICAL1 OPTICAL2</p>	Optical Inputs
 <p>R LINE-IN L</p>	RCA Input
 <p>R LINE-OUT L</p>	RCA Output
 <p>SUB-OUT</p>	Subwoofer Out
 <p>IR TRANSMITTER</p>	IR Transmitter
	Fuse Ratings T4AH 250V AC IN 100-240V



# Remote Control

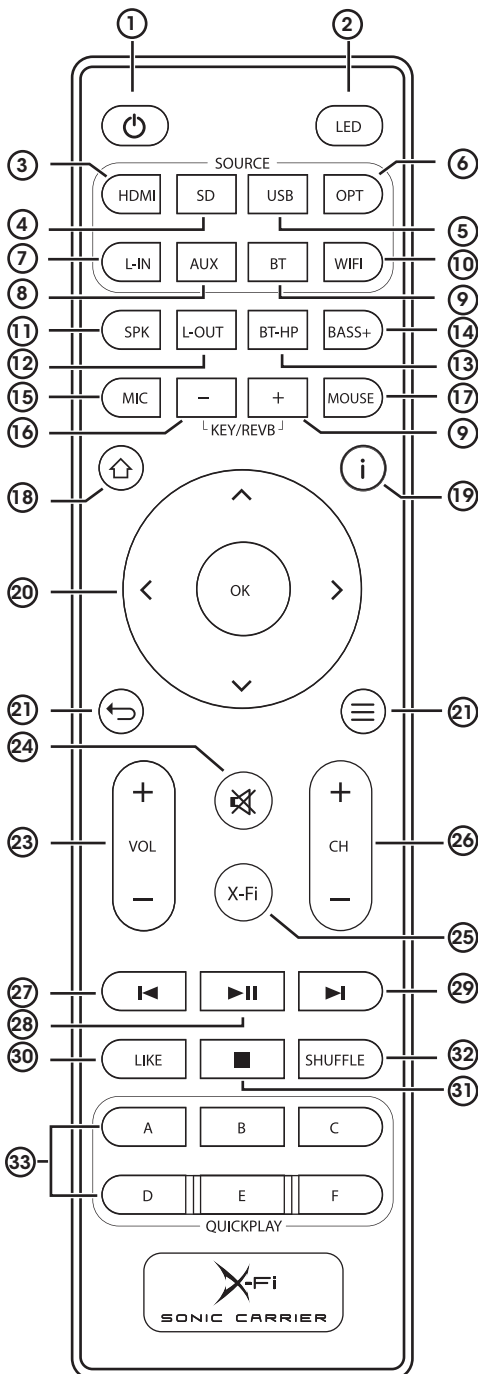

Button	Action
① Power	Turn On/Off main power
② LED	Cycles to the next LED preset on all the subwoofer
③ HDMI	Press to switch to the last accessed HDMI source, Press and hold to playback TV sound.
④ SD	Press to switch to the last accessed SD card, or to cycle between available SD card.
⑤ USB	Press to switch to the last accessed USB drive, or to cycle between available USB drives.
⑥ OPT	Press to switch to the last accessed Optical Input, or to cycle between available Optical Input.
⑦ L-In	Switch to Line In
⑧ Aux	Switch to Aux In
⑨ BT	Switch to Bluetooth In
⑩ WIFI	Switch to WIFI audio
⑪ SPK	Select sound output from main unit, mute Line-Out and BT headphone out
⑫ L-Out	Select sound output from Line-output, mutes main unit and Bt headphone out
⑬ Bt-HP	Select sound output from connected BT headphone, mutes main unit and Line-Out
⑭ Bass+	Bass Boost
⑮ Mic	Switch between microphone adjustment modes - Mic Volume, Key and Reverb
⑯ Key/Reverb -/+	Adjusts levels for Mic Volume, Key or Reverb
⑰ Mouse	Toggles On/Off mouse mode
⑱ Home	Display any info or menu for the Android Video Engine
⑲ Info	Display any info or menu for the Android Video Engine
⑳ Cursor & OK	Navigation and selection keys for the Android Video Engine
㉑ Return	Navigation and selection keys for the Android Video Engine/option
㉒ Exit	Navigation and selection keys for the Android Video Engine
㉓ VOL + /-	Increase/decrease volume
㉔ Mute	Mute/Unmute control
㉕ X-Fi	Turns on and off X-Fi SuperWide processing
㉖ CH +/-	Reserved for future use
㉗ Rewind/Previous	Previous track
㉘ Play / Pause	Toggle between play and pause
㉙ Forward / Next	Next track
㉚ Like	Reserved for future use
㉛ Stop	Stop playback
㉜ Shuffle	Toggle between shuffle and repeat playback mode
㉝ QuickPlay A-F	Custom buttons reserved for future use

# Specifications

## DIMENSIONS AND WEIGHT

### MAIN UNIT

Product name	: CREATIVE X-FI SONIC CARRIER
Model Number	: MF8235
Input rating	: 100-240V~50/60Hz 120W
Operating temperature range	: 0°C to 45°C
Dimensions (L x W x H)	: 1521 x 151 x 96mm (59.9" x 5.9" x 3.8")
Weight	: 16kg (35.3 lbs)

### ELECTRONIC AND ACOUSTIC SPECIFICATIONS

- Amplifier type: Class D
- System power: 1000W RMS, 2000W peak
- Main unit: 400W RMS, 800W peak
- Subwoofer: 600W RMS, 1200W peak

### ANDROID VIDEO PLAYBACK ENGINE

- Quad-core 64-bit high performance ARM Cortex A-53 with NEON processor 2GHz
- Mali T720 GPU with OPENGL ES3.1 support
- 2GB RAM, 16GB built-in flash storage
- Supports 4K 60fps video playback
- Supports H.265/HEVC Codec

### WI-FI AUDIO

- Supports DLNA, Tidal and Spotify Connect

### DRIVERS AND ACOUSTICS

- Sonic Carrier Main Unit Drivers
  - Five 1" coated aluminum alloy tweeters, capable of 40kHz high frequency reproduction
  - Eight 2.75" aluminum-magnesium alloy midbass drivers with individually sealed enclosures
  - Two 2.25" aluminum-magnesium alloy full-range drivers for surround channel reproduction with individually sealed enclosures

### WIRELESS AND WIRED CONNECTIVITY

- Bluetooth version: 4.1

#### Bluetooth

- Bluetooth version: 4.1
- Operating Frequency: 2402-2480MHz
- RF Output Power: <4dBm
- Bluetooth version: 4.0+EDR
- Operating Frequency: 2402-2480MHz
- RF Output Power: <4dBm

#### Wi-Fi 2.4GHz

- 802.11b/g/n
- Operating Frequency: 2412-2462MHz
- RF Output Power: <20dBm

#### Wi-Fi 5GHz

- 802.11a/n/ac
- Operating Frequency: 5180-5825MHz
- RF Output Power: <18dBm

#### Wireless audio link

- Operating Frequency: 2412 - 2464MHz
- RF Output Power: <17dBm
- Operating Frequency: 2402 - 2480 MHz
- Bluetooth codec: aptX®, aptX Low Latency, AAC, SBC
- Bluetooth profiles and features: A2DP receiver for audio playback on Sonic Carrier, A2DP transmission for audio playback on Bluetooth headphones, AVRCP (Bluetooth remote control)
- Bluetooth operating range: Up to 10M, measured in open space
- Bluetooth RF Output Power: <4dBm
- Wi-Fi: 802.11a/b/g/n/ac 2.4GHz & 5GHz
- Speaker-Speaker wireless link: 2.4Ghz. Supports up to 4 wireless subwoofers
- Speaker-Speaker wireless link operating range: Up to 10M, measured in open space.
- Line level input: Stereo 2Vrms analog RCA connectors
- Line level output: Stereo 2Vrms analog RCA connectors
- Auxiliary input: Stereo 1Vrms analog 3.5mm connector
- Microphone inputs: 2 x 1/4" microphone connector supporting most dynamic microphones
- USB host: 2 x USB 2.0 type A connector for USB flash drives and HDDs
- USB power: USB type A connector for providing power to peripheral devices (Rated 5V 2A)
- SD card slots: 1 x SD card slot, 3 x MicroSD card slots
- HDMI inputs: 4 x HDMI 2.0a with HDCP 2.2
- HDMI output: 1 x HDMI 2.0a with HDCP 2.2 and ARC
- Optical inputs: 2 x Toslink supporting up to 24Bit/96Khz
- Ethernet: 1 x Gigabit Ethernet
- Decoder support: Dolby Atmos, Dolby TrueHD, Dolby Digital Plus™, DTS:X upgradeable via firmware update
- Power supply: Auto-switching 100-240 V, 50-60 Hz AC universal input

Wireless performance is dependent on your device's Bluetooth or WiFi wireless technology. Refer to your device manufacturer's manual. Creative will not be liable for any lost of data or leakages resulting from the use of these devices.

Walls and structures may also affect range of device.

### Product Registration

Registering your product ensures you receive the most appropriate service and product support available. You can register your product during installation or at <http://www.creative.com/register>.

Please note that your warranty rights are not dependent on registration.

# Warranty

## Creative X-Fi Sonic Carrier- Limited Hardware Warranty

Creative Labs Pte Ltd and its affiliates ("Creative") warrants that the retail purchased Creative-branded hardware product herein ("Product") is free of material defects in materials and workmanship ("Defect(s)") that result in Product failure during normal consumer usage for the Warranty Period, according to the following terms and conditions:

1. This limited hardware warranty extends only to the original end-user purchaser and holder of this warranty ("You" or "Your") and is not transferable or assignable to any subsequent purchaser.
2. You must provide proof of original purchase of the Product by a dated itemized receipt to be eligible for this limited warranty.
3. The limited warranty is ONLY applicable in the country or territory where the Product was purchased from an authorized retailer/reseller and excludes any product that has not been purchased as new or is obtained as a result of the purchase of a non-Creative product.
4. If a Defect arises and a valid claim is received during the Warranty Period (as provided below), Creative will at its sole option, service the Product at no charge using new or refurbished replacement parts at our sole discretion. Please note that:
  - a. The limited warranty for the Product is for twenty-four (24) months (excluding all wear and tear), subject to certain exceptions as stated in the EU Directive 1999/44/EC\*\* from the date of delivery ("Warranty Period"). The Warranty Period will be extended by each whole day that the Product is out of Your possession for repair under this warranty.
  - b. Creative will cover the labor charges incurred by Creative in repairing or replacing the defective parts during the Warranty Period from the date of your purchase.
  - c. You will not have to pay for any such replacement parts.
  - d. Creative also warrants that the repaired or replaced parts will be free from defects in material and workmanship for the remainder of the Warranty Period.
  - e. For the limited warranty of the Product's Liquid Crystal Display, please refer to the Creative Support Web Page at [www.creative.com/support](http://www.creative.com/support).
5. This warranty gives You specific legal rights. You may also have other rights, which vary from state to state and country to country. The terms of this warranty do not exclude such rights or limit them. Your statutory rights are unaffected. Some states and countries do not allow (i) exclusions of, or limitations on, certain liabilities or warranties, including but not limited to how long a warranty lasts, the exclusion or limitation of incidental or consequential damages, or the exclusion of liability for injury (including death) caused by negligence, (ii) the inclusions of certain asymmetrical terms in warranties, or (iii) the expiration of all legal claims after a fixed time, so certain of the above limitations, exclusions or asymmetrical terms may not apply to You depending on the relevant jurisdiction. If adjudged invalid, such term(s) would be severable without affecting the validity of the other terms.
6. Creative does not warrant uninterrupted or error-free operation of the Product. Creative is not responsible for damage arising from failure to follow all or any instructions relating to the Product's use. Creative is not under any obligation to support the Product for all operating environments, including but not limited to, interoperability with both current and future versions of software or hardware.
7. For Products that are capable of storing data: Creative is not responsible or liable for any data stored on the Product that is lost, deleted or becomes otherwise inaccessible. All data may be deleted from the Product during servicing. You should remove or make a backup copy of any data stored on the Product before sending the Product to Creative.
8. If a problem develops during the Warranty Period, please refer to [www.creative.com/support](http://www.creative.com/support) or contact Your retailer/reseller. Please note that: (i) You must provide proof of original purchase of the Product by a dated itemized receipt; (ii) You shall bear the cost of shipping (or otherwise transporting) the Product to Creative. Creative will bear the cost of shipping (or otherwise transporting) the Product back to You after completing the warranty service; (iii) Before You send the Product to Creative, You must be issued a Return Merchandise Authorisation ("RMA") number from [www.creative.com/support](http://www.creative.com/support). Clearly write the RMA number on the outside of the package containing the Product being sent to Creative. Creative will not accept a return that does not have a RMA number on the outer packaging; and (iv) You can only return the defective Product(s) not excluded under Section 9 below. Creative is not responsible for other products or accessories returned with the defective Product(s). Creative reserves the right to change the method by which Creative may provide warranty service to you, and your Product's eligibility to receive a particular method of service. Service will be limited to the options available in the country where service is requested. Service options, parts availability and response times may vary according to country. For further details on Creative Warranty terms, Product returns and repair procedure, Creative customer support services and contact information, please refer to the support section of Creative's web site at [www.creative.com/support](http://www.creative.com/support).
9. The limited warranty does not apply to:
  - a. Consumable parts, such as batteries or protective coatings that, due to their nature, tend to diminish over time, unless failure has occurred due to a defect in materials or workmanship;
  - b. Damage caused by normal wear and tear, abnormal use or conditions, misuse, neglect, abuse, accident, improper handling or storage, defects or damages resulting from service, testing, adjustment, installation, maintenance, alteration, including without limitation, software changes, or modification in any way by someone other than Creative or its authorised service centres, improper use of any electrical source, undue physical or electrical stress, operator error, non-compliance with instructions or other acts which are not the fault of Creative, including damage or loss during shipment or transit.
  - c. Damage from external causes such as floods, storms, fires, sand, dirt, earthquakes, an Act of God, exposure to sunlight, weather, moisture, heat, vibration or corrosive environments, electrical surges, battery leakage, theft, or damage caused by the connection to other products not recommended for interconnection.
  - d. Damage or loss of data due to (i) interoperability with either or both current and future versions of operating systems or other current or future software and hardware, (ii) a computer virus, worm, spyware, Trojan horse or memory content corruption, or (iii) malfunction or defect of the Product.
  - e. Counterfeit products/parts or any accompanying products/parts that are incompatible with the Product.
  - f. Any Product that: (i) has had its serial number altered, defaced or removed; (ii) shows evidence of tampering; (iii) mismatched board serial numbers; or (iv) has non-conforming or non-Creative housing or casing.
  - g. Any accessories including but not limited to disposable alkaline batteries, removable fuses, screen protectors, plugs and pouches.
  - h. Any defect occurring after the expiration of the Warranty Period or where Creative was not advised in writing of an alleged defect or malfunction within seven (7) days after the expiration of the Warranty Period.
10. Any Product determined by Creative to be warranty-expired, warranty-void or not in need of repair will be subject to a minimum non-refundable diagnostic and handling fee. In the event that You fail to make the payment, Creative may, at its sole discretion, dispose of the Product without notice and liability to You.
11. Subject to any non-excludable limit under applicable law, the maximum liability under this limited warranty is the original price paid for the Product (excluding any shipping and additional charges). Creative and its affiliated companies will not be liable for any other losses or damage unless liability is non-excludable under applicable law. The remedy stated is Your exclusive remedy for breach of warranty. Any action or lawsuit for breach of this limited warranty must be commenced within eighteen (18) months following the original purchase of the Product or within the limitation period under applicable law.
12. IN SO FAR AS PERMITTED BY LAW, THE PRODUCT AND THE SERVICED PRODUCT IS PROVIDED "AS IS". TO THE EXTENT PERMITTED BY APPLICABLE LAW, CREATIVE AND ITS AFFILIATED COMPANIES HEREBY DISCLAIM THE APPLICABILITY OF ANY IMPLIED WARRANTY OF MERCHANTABILITY, FITNESS FOR A PARTICULAR PURPOSE OR USE FOR THE PRODUCT AND/OR THE SERVICED PRODUCT. CREATIVE AND ITS AFFILIATED COMPANIES WILL NOT BE LIABLE FOR ANY INDIRECT, INCIDENTAL, SPECIAL, PUNITIVE OR CONSEQUENTIAL DAMAGES, INCLUDING BUT NOT LIMITED TO ANY LOST PROFITS, SAVINGS, DATA, OR LOSS OF USE, ANY THIRD PARTY CLAIMS, AND ANY INJURY TO PROPERTY OR BODILY INJURY (INCLUDING DEATH) TO ANY PERSON, ARISING FROM OR RELATING TO THE USE OF THE PRODUCT OR ARISING FROM BREACH OF THE WARRANTY, BREACH OF CONTRACT, NEGLIGENCE, TORT, OR STRICT LIABILITY, EVEN IF CREATIVE OR ANY OF ITS AFFILIATED COMPANIES HAS BEEN ADVISED OF THE POSSIBILITY OF SUCH DAMAGES.
13. For Australia only: Our goods come with guarantees that cannot be excluded under the Australian Consumer Law. You are entitled to a replacement or refund for a major failure and for compensation for any other reasonably foreseeable loss or damage. You are also entitled to have the goods repaired or replaced if the goods fail to be of acceptable quality and the failure does not amount to a major failure. Goods presented for repair may be replaced by refurbished goods of the same type rather than being repaired. Refurbished parts may be used to repair the goods. (Creative Technology Ltd, 31 International Business Park, #03-01 Creative Resource, Singapore 609921. Telephone: +65 6895 4433 (standard international call charges apply.))
14. This is the entire warranty and supersedes all prior and contemporaneous agreements or understandings, oral or written, relating to warranty coverage for the Product, and no representation, promise or condition not contained herein will modify these terms.
15. Update(s) of this Limited Hardware Warranty may be posted at [www.creative.com/support](http://www.creative.com/support). An Update will replace any earlier version upon posting on the web site. You are advised to check for Update(s).

\*\* A seller in the European Union (EU) may be entitled to refuse to repair or replace the goods if it is (i) impossible or (ii) disproportionate (eg. where the costs are unreasonably high for the seller) to do so, taking into account the value the goods would have had (if there were no lack of conformity), the significance of the lack of conformity and where an alternative remedy would be completed without significant inconvenience to the consumer. In such cases, the consumer may ask for an appropriate reduction of the price or have the contract rescinded. The consumer is not entitled to have the contract rescinded if the lack of conformity (or defect or fault) is minor. In which case, the seller is entitled to turn down a request for rescission of the contract in such a situation. For further details, please refer to Articles 3(3), 3(5) and 3(6) of the EU Directive 1999/44/EC.

CREATIVE®

soniccarrier.com

Complies with  
IMDA Standards  
DA107311



The Spotify software is subject to third party licenses found here:  
[www.spotify.com/connect/third-party-licenses](http://www.spotify.com/connect/third-party-licenses)

© 2017 Creative Technology Ltd. All rights reserved. Creative, the Creative logo, X-Fi, the X-Fi logo, Sonic Carrier and SuperWide X-Fi are trademarks or registered trademarks of Creative Technology Ltd in the United States and/or other countries. Dolby, Dolby Atmos, and the double-D symbol are registered trademarks of Dolby Laboratories. Wi-Fi is a trademark of Wi-Fi Alliance. Android is a trademark of Google Inc. The *Bluetooth*® word mark and logos are registered trademarks owned by Bluetooth SIG, Inc. and any use of such marks by Creative Technology Ltd is under license. Other trademarks and trade names are those of their respective owners. All specifications are subject to change without notice. Actual product may differ from slightly from images shown. All images are for illustration purposes only. State of California Proposition 65 WARNING: This product may expose you to chemicals known to the State of California to cause cancer and birth defects or other reproductive harm. Explanatory Note: To meet the requirements of Proposition 65, it is our responsibility to notify consumers in the State of California that they may be exposed to chemicals that are known to cause cancer and/or reproductive toxicity. It does not mean that the product is in violation of any product-safety standards or requirements. The exposure may be below the level of concern, or even zero. For additional information, visit [www.P65Warnings.ca.gov](http://www.P65Warnings.ca.gov).

PN 03MF82350000 RevA