

Zii

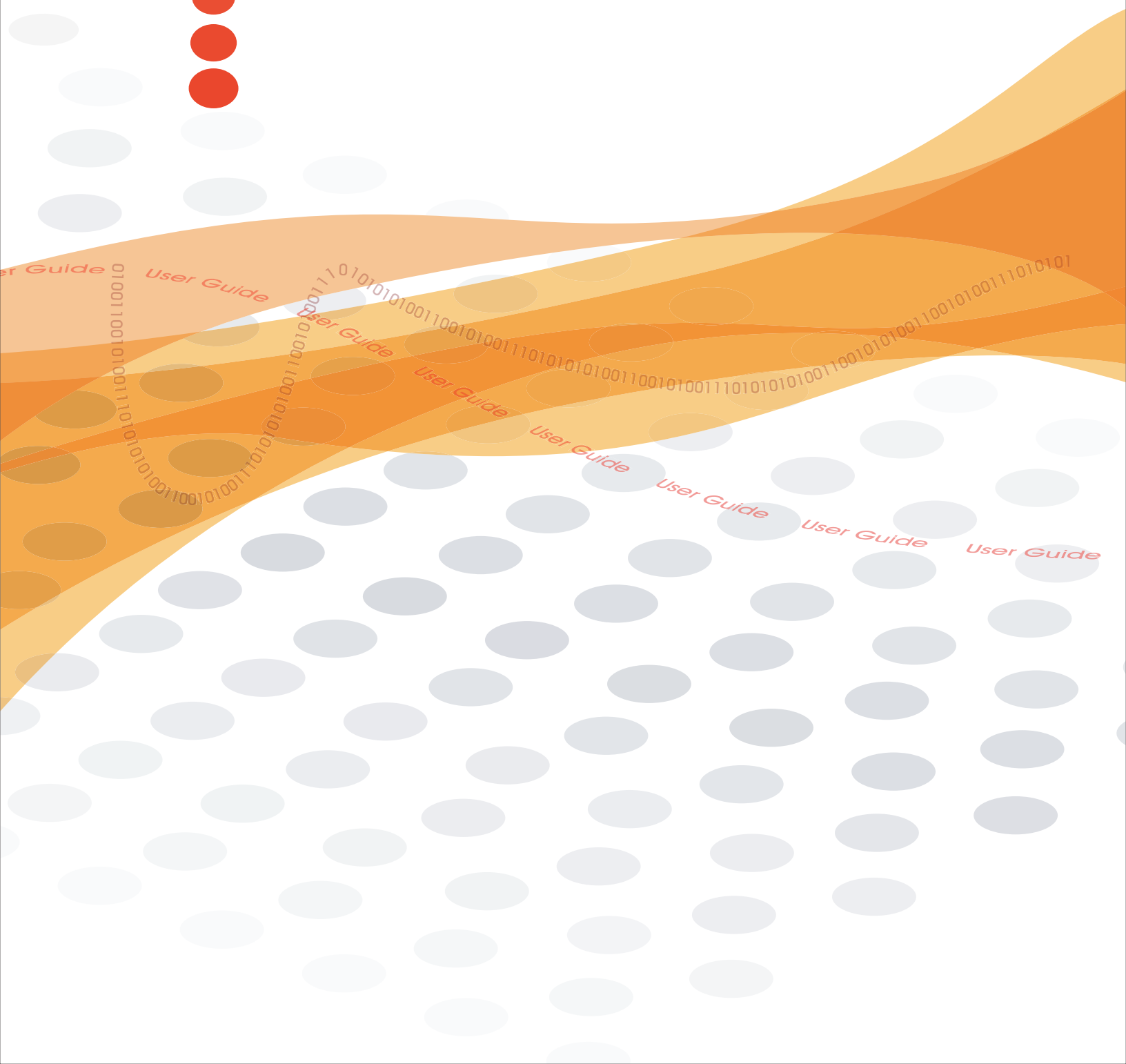

User Guide



Contents

| | |
|---|------------|
| Preface | iii |
| Audience | iii |
| Document Conventions | iii |
| License and Copyright | iv |
| | |
| CHAPTER 1 Getting Started | 1-1 |
| Introducing Current Zii Features | 1-2 |
| Parts of Your Device | 1-2 |
| Getting Device Information | 1-2 |
| Using Wi-Fi | 1-3 |
| Turning on Wi-Fi | 1-3 |
| Setting to Airplane Mode | 1-3 |
| Connecting to a Network | 1-4 |
| Adding a Network | 1-4 |
| Checking Out the Accessories | 1-5 |
| Enjoying High Density Audio/Video | 1-5 |
| Playing Audio/Video on Bigger Screens | 1-6 |
| Charging Zii and Transferring Media | 1-7 |
| Docking Zii and Connecting to Other Devices | 1-8 |
| | |
| CHAPTER 2 Managing Audio Files | 2-1 |
| Playing a Music Track | 2-2 |
| Managing Playlists | 2-2 |
| Adding Tracks to a Playlist | 2-2 |
| Editing a Playlist | 2-2 |
| | |
| CHAPTER 3 Capturing Images | 3-1 |
| Using the Camera | 3-2 |
| Using the Video Camera | 3-2 |
| | |
| CHAPTER 4 Viewing Photos and Videos | 4-1 |
| Viewing Photo and Photo Details | 4-2 |
| Viewing Video Details | 4-2 |
| Playing Videos | 4-2 |

CHAPTER 5 Safety & Regulatory Information 5-1

- Regulatory Information. **5-1**
 - Notice for the USA. 5-1
 - Notice for Canada. 5-3
 - European Compliance 5-4
 - Notice for Australia and New Zealand. 5-7
- Safety Information **5-8**

Preface

Welcome to the Zii device user manual. This manual is still being developed and contains instructions on using the applications on your Zii device that are ready as of March 2009. You can also obtain an overview of Zii accessories in this manual.

This preface discusses the following topics:



- Audience
- Document conventions

Audience

This Zii device user guide is written for users who possess an average level of competency with electronic products. The document assumes that users are familiar with basic music playback, and photo taking or video recording.

Document Conventions

The following table lists the conventions used in this document to help you better interpret and understand the contents.

| Conventions | Descriptions |
|---|---|
| ALL UPPERCASE | Abbreviations and acronyms. |
| Bold | Menu commands, buttons, headings. |
| <i>Italics</i> | References to other documentations. |
| Monospace | File names, command lines, program codes, program output. |
| Blue underline | Web URL, internal document links. |
|  | Important information to take note of. |
|  | Tips and recommendations. |
| WARNING! | Actions that should be avoided to prevent unwanted results. |

License and Copyright

Information in this document is subject to change without notice and does not represent a commitment on the part of Creative Technology Ltd. No part of this manual may be reproduced or transmitted in any form or by any means, electronic or mechanical, including photocopying and recording, for any purpose without the written permission of Creative Technology Ltd.

Zii and the Creative logo are trademarks or registered trademarks of Creative Technology Ltd. in the United States and/or other countries. Microsoft and Windows are trademarks or registered trademarks of Microsoft Corporation in the United States and/or other countries. Intel and Pentium are registered trademarks of Intel Corporation in the United States and/or other countries.

Gracenote is CDDDB, Inc. d/b/a ""Gracenote."" CD and music-related data from Gracenote CDDDB® Music Recognition ServiceSM © 2000, 2001, 2002 Gracenote. Gracenote CDDDB Client Software © 2000, 2001, 2002 Gracenote. U.S. Patents Number #5,987,525; #6,061,680; #6,154,773, and other patents issued or pending.

CDDDB is a registered trademark of Gracenote. The Gracenote logo and logotype, the Gracenote CDDDB logo and logotype, and the "Powered by Gracenote CDDDB" logo are trademarks of Gracenote. Music Recognition Service and MRS are service marks of Gracenote.

All other products are trademarks or registered trademarks of their respective owners.

Copyright © 2009 by Creative Technology Ltd. All rights reserved.

The Software License Agreement is found in a separate folder on the Installation and Applications CD.

Version 1.00.01

March 2009

This chapter discusses the following topics:

- Introducing current Zii features
- Parts of your device
- Getting device information
- Using Wi-Fi
- Checking out the accessories

Introducing Current Zii Features

Zii encompasses all you need for personal digital entertainment. This revolutionary electronic device comes with a comprehensive range of features that add a magical touch to your mobile life:

- Music player
- Camera
- Video recorder
- Photo browser and video player

Stay tuned for more features that will be available at a later phase.

Parts of Your Device

FIGURE 1-1. Parts of your device

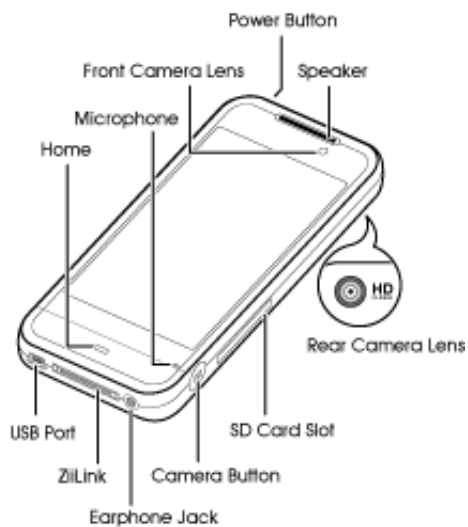

Getting Device Information

To find out more information about your device, such as the model and storage space, do the following:

1. Touch **Settings** on the Home menu.
2. Select **About**.

Using Wi-Fi





Wi-Fi (Wireless Fidelity) is a commonly used wireless network that enables connection to the Internet or other devices that support Wi-Fi. This section provides instructions on how to use Wi-Fi and add wireless networks to your Zii.

Turning on Wi-Fi

Turn on Wi-Fi to detect the wireless networks available at your location:

1. Touch **Settings** on the Home menu.
2. Select **Wi-Fi**.
3. Touch the **Wi-Fi Network** button.
Zii displays a list of the networks that it detected.

TABLE 1-1. Wi-Fi icons

| Icons | Descriptions |
|---|-----------------------|
|  | Preferred network |
|  | Secured with password |
|  | Secured |
|  | Strong signal |
|  | Weak signal |

Setting to Airplane Mode

Turn off Wi-fi where its use is prohibited due to interference with other electronic devices. An aircraft in motion, hospitals, and refuelling points are examples of areas where prohibition is imposed.

1. Touch **Settings** on the Home menu.
2. To turn on, touch the **Airplane Mode** button.
To turn off, touch the **Airplane Mode** button again. When turned off, this button appears dimmed. Zii automatically connects to the previously connected wireless network if the network connection is available.

Connecting to a Network

The first time you attempt to connect to a security-enabled network, you may be prompted to enter a password. Upon successful verification of the password, Zii connects you to the network and saves the password so you do not have to re-enter the information during subsequent connection.

Once connected, the IP address and a **View More** button appear on the selected network on the network list. If desired, you may add the network to your preferred list.

Adding a Network

1. Touch **Plus** (+) on the list of network screen.
2. Type the necessary network information and touch **OK**.
Zii attempts to connect to the network. Upon successful connection, you may answer **Yes** when prompted to add the new network to your preferred list.

Checking Out the Accessories

Your Zii is bundled with the following accessories:

- Earphones
- Zii USB mini cable
- Zii universal power adapter

The following section provides an overview on some Zii accessories. For more information on other Zii accessories, visit support.zii.com.

Enjoying High Density Audio/Video

Use Zii HD Receptacle Cable to charge Zii, transfer files, and enjoy first-class digital audio/video simultaneously.

FIGURE 1-2. Zii HD Receptacle Cable

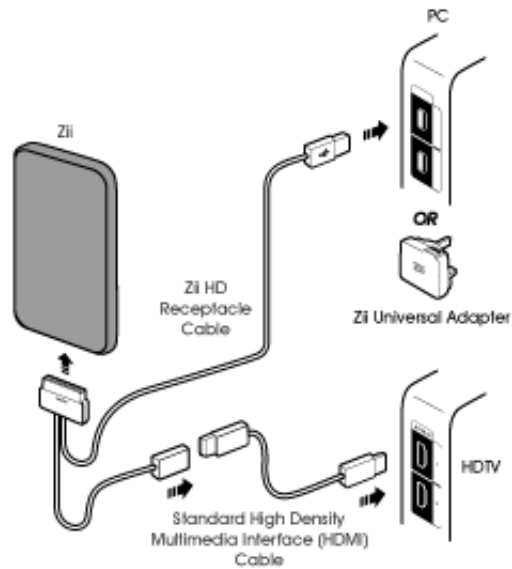

Playing Audio/Video on Bigger Screens

Use Zii AV Cable to channel audio/video from Zii to bigger screens such as televisions or your computer monitors.

1. Touch **Settings** on the Home menu of your Zii.
2. Select **General > TV Output**.
3. Select the desired protocol and resolution.

FIGURE 1-3. Zii AV Cable

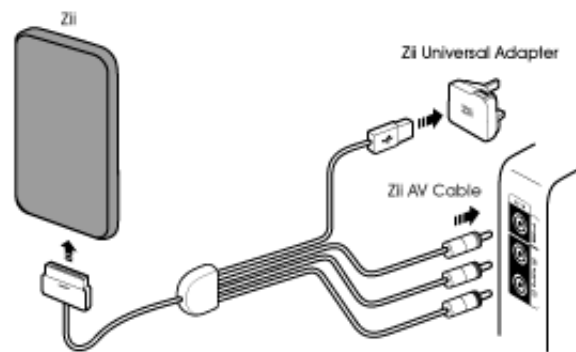

Charging Zii and Transferring Media

Use Zii USB Cable or Zii Mini USB Cable to charge Zii or transfer media files on the computer.

FIGURE 1-4. Zii USB Cable

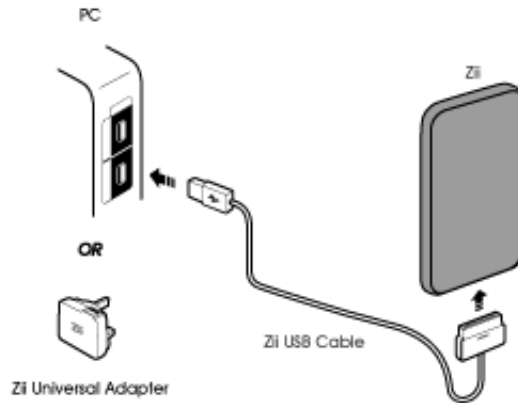
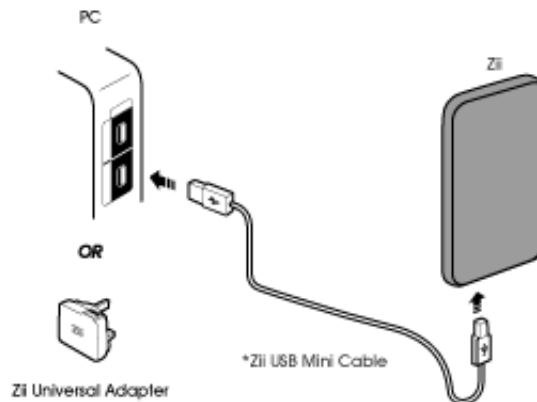

FIGURE 1-5. Zii USB Mini Cable



Docking Zii and Connecting to Other Devices

Use Zii Dock as a desktop stand to charge Zii and connect to devices such as speakers, televisions, or computers simultaneously.

FIGURE 1-6. Zii Dock

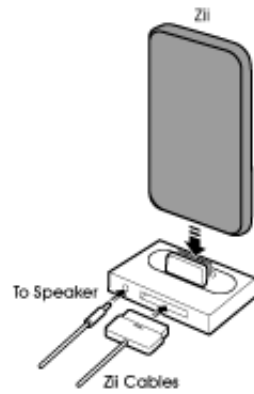

This chapter discusses the following topics:

- Playing music track
- Managing playlists

Playing a Music Track

1. Touch the Music icon on the Home menu.
2. Select any of the desired music options, such as playlist or albums on the Music menu.
3. Select the track that you want to play.
4. To view the ratings and progress bar, tap anywhere on the album art.

Managing Playlists

You can select audio tracks that you frequently listen to and compile them into a playlist. You are free to add favorite tracks, or delete tracks from this list as your preference changes, or as your collections grow.

Adding Tracks to a Playlist

To create a playlist, add the desired tracks to the list of selected music first. You can then save them as a playlist once you have completed the selection.

1. Select **All Tracks** on the Music menu.
2. Touch the **Plus (+)** icon.
This icon appears next to all the listed tracks.
3. Select the desired tracks to add to the playlist.
4. Touch **OK**.
5. Touch **Options**  on the Selected Music screen.
6. Select **Save as Playlist**.
7. Type a name for the playlist and touch **OK**.

Editing a Playlist

To reorder tracks in a playlist

1. Select **Playlists** on the Music menu.
2. Touch the **Edit** button.
3. To reorder a track, simply select and drag it up or down the list.
4. Touch **Save**.

To delete tracks from a playlist

1. Select **Playlists** on the Music menu.
2. Select the specific playlist that you want to edit.
3. Do one of the following:
 - Touch **Options**  and select **Remove Track**.
 - Alternatively, touch the **Edit** button.A trashcan appears next to each track.
4. Select the unwanted track.
A tick appears on the selected track.
5. Touch **OK** to confirm the deletion.

This chapter discusses the following topics:

- Using the camera
- Using the video camera



Using the Camera

Your Zii camera supports the half-pressed mode. This allows you to press the shutter button lightly to establish focus on the subject before you press the button fully to snap the photo. If desired, you can drag the focus frame to position it on another area of the image.

To zoom in/out on the image

1. Touch the magnifier .
2. Drag the slider bar up or down to zoom in or zoom out respectively.

Using the Video Camera

1. To switch from the camera mode to video mode, touch .
2. Select **Video mode** .
3. Press the shutter button to begin recording.
The elapsed time appears at the top center of your screen.
4. Press the shutter button again to stop recording.

This chapter discusses the following topics:

- Viewing photo and photo details
- Viewing video details
- Playing videos

Viewing Photo and Photo Details

To view photos, touch the **Photo** icon on the Home menu. You can also find out more information about a photo, such as the filename, size, date, and the time the photo was taken.

To display the details

1. Touch **Options**  when viewing a photo.
2. Select **View Picture Details**.

Viewing Video Details

When you select a video on Zii, you can view information such as descriptions of the video, duration, and the starring artistes, before you decide whether to watch the video.

1. Touch **Video** on the Home menu.
A list of videos appears.
2. Select the video that you want to view.
The video information appear.
3. To view video details, do the following:
 - a. Touch **Options** .
 - b. Select **View Details**.

Playing Videos

You can control the playback speed when watching a video.



To fast forward a video

1. Touch **Video**.
A list of videos appears.
2. Select the video that you want to play.
3. Touch the fast forward icon  when the video is displayed.
The playback control bar appears.
4. To fast forward, drag your finger along the bar to the desired speed.
5. Tap on the video screen to hide the playback control bar so that you can resume watching the video with no obstruction.



While in play mode, you can also swipe your finger to the right or left to perform a forward or backward scan of the video.



To playback a video in slow motion

1. Touch  to pause the video.
2. Touch the fast forward icon  in pause mode.
3. Drag your finger along the playback control bar to select a slower speed.



While in the play or pause mode, you can also swipe your finger to the right or left to perform a forward or backward scan of the video frames.

To adjust the volume

Tap on the video screen. The progress bar changes to the volume bar. You can then touch  or  to increase or decrease the volume respectively.

If desired, you may tap on the video screen again to hide all buttons/icons to view the video with no obstruction.

Regulatory Information

The following sections contain notices for various countries:

CAUTION: This product is intended for use with FCC/CE certified computer equipment. Please check the equipment operating/installation manual and/or with the equipment manufacturer to verify/confirm if your equipment is suitable prior to the installation or use of the product.

Notice for the USA

Federal Communication Commission (FCC) Interference Statement

FCC Part 15: This equipment has been tested and found to comply with the limits for a Class B digital device, pursuant to Part 15 of the FCC Rules. These limits are designed to provide reasonable protection against harmful interference in a residential installation. This equipment generates, uses and can radiate radio frequency energy and, if not installed and used in accordance with the instructions, may cause harmful interference to radio communications. However, there is no guarantee that interference will not occur in a particular installation. If this equipment does cause harmful interference to radio or television reception, which can be determined by turning the equipment off and on, the user is encouraged to try to correct the interference by one or more of the following measures:

- Reorient or relocate the receiving antenna.
- Increase the separation between the equipment and receiver.
- Connect the equipment into an outlet on a circuit different from that to which the receiver is connected.
- Consult the dealer or an experienced radio/TV technician for help.

This device complies with part 15 of the FCC Rules. Operation is subject to the following two conditions:

1. This device may not cause harmful interference, and
2. This device must accept any interference received, including interference that may cause undesired operation.

CAUTION: To comply with the limits of the Class B digital device, pursuant to Part 15 of the FCC Rules, this device must be installed with computer equipment certified to comply with Class B limits.

All cables used to connect to the computer and peripherals must be shielded and grounded. Operation with non-certified computers or non-shielded cables may result in interference to radio or television reception.

MODIFICATION: Any changes or modifications not expressly approved by the grantee of this device could void the user's authority to operate the device.

Federal Communication Commission (FCC) Radiation Exposure Statement

This equipment complies with FCC radiation exposure limits set forth for an uncontrolled environment. This transmitter must not be co-located or operating in conjunction with any other antenna or transmitter.

For body operation, IBANSC-FL02 has been tested and meets the FCC RF exposure guidelines when used directly against the body. Specific Absorption Rate, or SAR is a measurement of radio frequency energy. The FCC permits a maximum SAR value of 1.6 mW/g. The highest SAR value for this product when used on the body, as described in this user's guide, is 1.26 mW/g.

California Proposition 65 Statement

WARNING: Handling this product may expose you to chemicals known to the State of California to cause cancer and birth defects or other reproductive harm.

Wash hands after handling.

Explanatory Note: California Safe Drinking Water and Toxic Enforcement Act of 1986 (Proposition 65) requires special product labeling for products containing certain chemicals known to the State of California to cause cancer, birth defects or other reproductive harm. Creative has chosen to provide a warning based on its knowledge about the presence of one or more listed chemicals without attempting to evaluate the level of exposure. With Creative's products, the exposure may be below the Proposition 65 level of concern, or could even be zero. However, out of an abundance of caution, Creative has elected to place the Proposition 65 warning on its products.

Déclaration de la Proposition 65 de la Californie

AVERTISSEMENT: La manipulation de ce produit peut vous exposer à des produits chimiques qui sont reconnus par l'État de la Californie comme pouvant provoquer le cancer, des anomalies congénitales ou d'autres effets nuisibles à la reproduction.

Veillez vous laver les mains après l'avoir manipuler.

Note explicative: La Proposition 65 (California Safe Drinking Water and Toxic Enforcement Act of 1986) de la Californie sur les matières dangereuses et l'eau potable exige un étiquetage spécial pour les produits contenant certains produits chimiques qui sont reconnus par l'État de la Californie comme pouvant provoquer le cancer, des anomalies congénitales ou d'autres effets nuisibles à la reproduction. Creative a choisi d'inclure une mise en garde s'appuyant sur sa connaissance de la présence d'un ou de plusieurs de ces produits chimiques sans essayer d'en évaluer le niveau d'exposition. Pour les produits de Creative, le niveau d'exposition peut être inférieur au niveau critique établi par la Proposition 65 ou même être nul. Néanmoins, par souci extrême de prudence, Creative a choisi de placer l'avertissement de la Proposition 65 sur ses produits.

Notice for Canada

This Class B digital apparatus complies with Canadian ICES-003.

Cet appareil numérique de la classe B est conforme à la norme NMB-003 du Canada.

CANADIAN CLASS B STATEMENT: This digital device does not exceed the Class B limits for radio noise emissions from digital apparatus as set out in the interference-causing equipment standard entitled "Digital Apparatus," ICES-003 of the Department of Communications.

Cet appareil numérique respecte les limites de bruits radioélectriques applicables aux appareils numériques de Classe B prescrites dans la norme sur le matériel brouilleur: "Appareils Numériques," NMB-003 édictée par le ministre des Communications.

MODIFICATION: Any changes or modifications not expressly approved by the grantee of this device could void the user's authority to operate the device.

Toute modification non approuvée explicitement par le fournisseur de licence de l'appareil peut entraîner l'annulation du droit de l'utilisateur à utiliser l'appareil.

European Compliance

This product conforms to the following:

EMC Directive 2004/108/EC.

Mains operated products for the European market comply with Low Voltage Directive 2006/95/EC.

Communication / RF wireless products for the European market comply with R&TTE Directive 1999/5/EC.

CAUTION: To comply with the Europe CE requirement, this device must be installed with CE certified computer equipment which meet with Class B limits.

All cables used to connect this device must be shielded, grounded and no longer than 3m in length. Operation with non-certified computers or incorrect cables may result in interference to other devices or undesired effects to the product.

MODIFICATION: Any changes or modifications not expressly approved by Creative Technology Limited or one of its affiliated companies could void the user's warranty and guarantee rights.

DECLARATION OF CONFORMITY

According to LVD Directive (2006/95/EC) and R&TTE Directive (1999/5/EC)

Company Name: **Creative Technology Ltd**
Company Address: **31, International Business Park**
Creative Resource
Singapore 609921

Declare under our sole responsibility that the product(s):

Product Name: Zii EGG
Model Number: NSC-FL02

To which this declaration relates are in conformity with the following standard(s):

R&TTE: EN 300 328 V1.7.1:2006
EMI/EMC: EN 55013: 2001 + A1: 2003 + A2: 2006
EN 55020: 2007
EN 301 489-1 V1.6.1:2005
EN 301 489-17 V1.2.1:2002
Safety: EN 60950-1: 2001 + A11: 2004

Safety & Regulatory Information

SAR: EN 50360: 2001
EN 50361: 2001
EN 62209-1: 2006

Technical documentation for this product(s) is retained at the following address:

Company Name: Creative Technology Ltd
Company Address: 31, International Business Park
Creative Resource
Singapore 609921



UK: Hereby, Creative Technology Ltd. declares that this Zii EGG is in compliance with the essential requirements and other relevant provisions of Directive 1999/5/EC

FR: Par la présente Creative Technology Ltd. déclare que l'appareil Zii EGG est conforme aux exigences essentielles et aux autres dispositions pertinentes de la directive 1999/5/EC

IT: Con la presente Creative Technology Ltd. dichiara che questo Zii EGG è conforme ai requisiti essenziali ed alle altre disposizioni pertinenti stabilite dalla direttiva 1999/5/EC

DE: Hiermit erklärt Creative Technology Ltd. dass sich Creative dieser / diese / dieses Zii EGG in Übereinstimmung mit den grundlegenden Anforderungen und den anderen relevanten Vorschriften der Richtlinie 1999/5/EG befindet". (BMW i)

ES: Por medio de la presente Creative Technology Ltd. Declara que el Zii EGG cumple con requisitos esenciales y cúa lesquiera otras disposiciones aplicables o exigibles de la Directiva 1999/5/CE

NL: Bij deze verklaart Creative Technology Ltd. dat deze Zii EGG vol doet aan de essentiële eisen en aan de overige relevante bepalingen van Richtlijn 1999/5/EC.

PT: Creative Technology Ltd. declara que este Zii EGG está conforme com os requisitos essenciais e outras disposições da Directiva 1999/5/EC

SV: Härmed intygar Creative Technology Ltd. att denna Zii EGG står i överensstämmelse med de väsentliga egenskapskrav och övriga relevanta bestämmelser som framgår av direktiv 1999/5/EG

DA: Undertegnede Creative Technology Ltd. erklærer herved, at følgende udstyr Zii EGG overholder de øvrige relevante krav i direktiv 1999/5/EF.

FI: Creative Technology Ltd. vakuuttaa täten että Zii EGG tyyppinen laite on direktiivin 1999/5/EY oleellisten vaatimusten ja sitä koskevien direktiivin muiden ehtojen mukainen.

NO: Creative Technology Ltd. erklærer herved at denne Zii EGG er i overensstemmelse med vesentlige krav og andre relevante bestemmelser i EU-direktivet 1999/5/EC.

RU: Creative Technology Ltd. подтверждает, что изделие Zii EGG соответствует основным требованиям и другим существенным условиям указания Европейской комиссии No. 1999/5/EC

PL: Creative Technology Ltd. stwierdza niniejszym, że Zii EGG spełnia podstawowe wymagania oraz inne właściwe rzeczowo warunkami Dyrektywy 1999/5/EC.

CZ: Creative Technology Ltd. tímto potvrzuje, že Zii EGG splňuje podstatní požadavky a jiné závazné předpisy Direktivy 1999/5/EC.

Notice for Australia and New Zealand



This product complies with the requirements of the ACMA Radiocommunications (Electromagnetic Compatibility) Standard 2008.

Safety Information

Refer to the following information to use your product safely, and to reduce the chance of electric shock, short-circuiting, damage, fire, hearing impairment or other hazards. **Improper handling may void the warranty for your product. For more information, read the warranty available with your product.**

- Do not dismantle or attempt to repair your product.
Refer all servicing to authorized repair agents.
- Do not expose your product to temperatures outside the range of 0°C to 45°C (32°F to 113°F).
- Do not pierce, crush or set fire to your product.
- Keep your product away from strong magnetic objects.
- Do not subject your product to excessive force or impact.
- Do not expose your product to water or moisture.

If your product is moisture-resistant, take care not to immerse your product in water or expose it to rain.

Earphones

- When a conductive apparatus such as earphones, is used in close proximity with a CRT television or CRT monitor, the latter may emit an electrostatic discharge. This electrostatic discharge can be felt as a static shock. While this static shock is usually harmless, it is good practice to avoid close contact with CRT devices when using earphones.
- Do not listen to audio on your earbuds or headphones at high volume for prolonged periods of time as hearing loss may result. For users in the United States, go to www.hei.org for more information.
- Do not listen to your audio device at high volume when driving, cycling or crossing the road, especially in heavy traffic, or in any other traffic condition where such use will hinder safe travel on the roads. We recommend that consumers be extremely cautious when using this device on the road.

Embedded Battery

Do not attempt to remove the embedded battery.

The product must be disposed of according to local environmental regulations. To replace the battery, return your product to your regional support office. For product service information, go to www.creative.com.

CAUTION: Risk of explosion if battery is replaced by incorrect types.

Removable Battery

- The battery must be recycled or disposed of properly. Contact local agencies for recycling and disposal information.
- Do not allow metal objects to touch the terminals of your battery.
- If there is leakage, an offensive odor, discoloration or deformation during charging or use, remove the battery and do not use it again. Clean your hands well before touching food or sensitive areas, for example, your eyes.

CAUTION: Risk of explosion if battery is replaced by incorrect types.

Wireless LAN Device

Switch off the device where it is prohibited, or when its use may cause danger or interference, such as when inside an aircraft, in hospitals, or near refuelling stations.

Bluetooth Product

Do not turn on or use your product in an airplane.

