

Crestron **TPMC-3X**
Isys i/O[®] 2.8" Handheld WiFi Touchpanel
Operations Guide



This document was prepared and written by the Technical Documentation department at:



Crestron Electronics, Inc.
15 Volvo Drive
Rockleigh, NJ 07647
1-888-CRESTRON

Regulatory Compliance

As of the date of manufacture, the TPMC-3X has been tested and found to comply with specifications for CE marking and standards per EMC and Radiocommunications Compliance Labelling.



Federal Communications Commission (FCC) Compliance Statement

This device complies with part 15 of the FCC rules. Operation is subject to the following conditions: (1) this device may not cause harmful interference and (2) this device must accept any interference received, including interference that may cause undesired operation.

CAUTION: Changes or modifications not expressly approved by the manufacturer responsible for compliance could void the user's authority to operate the equipment.

NOTE: This equipment has been tested and found to comply with the limits for a Class B digital device, pursuant to part 15 of the FCC rules. These limits are designed to provide reasonable protection against harmful interference in a residential installation. This equipment generates, uses and can radiate radio frequency energy and if not installed and used in accordance with the instructions, may cause harmful interference to radio communications. However, there is no guarantee that interference will not occur in a particular installation. If this equipment does cause harmful interference to radio or television reception, which can be determined by turning the equipment off and on, the user is encouraged to try to correct the interference by one or more of the following measures:

- Reorient or relocate the receiving antenna
- Increase separation between the equipment and the receiver
- Connect the equipment into an outlet on a circuit different from that to which the receiver is connected
- Consult the dealer or an experienced radio/TV technician for help

Industry Canada (IC) Compliance Statement

Operation is subject to the following two conditions:

1. This device may not cause interference, and
2. This device must accept any interference, including interference that may cause undesired operation of the device.

To satisfy RF exposure requirements, this device and its antenna must operate with a separation distance of at least 20 centimeters from all persons and must not be collocated or operating in conjunction with any other antenna or transmitter.

For operation within the 5.15-5.25 GHz band, it is restricted to indoor use.

Contents

Isys i/O® 2.8" Handheld WiFi Touchpanel: TPMC-3X	1
Introduction	1
Features and Functions	1
Applications	4
Specifications	6
Physical Description	8
Setup	12
Identity Code	12
Battery Installation	12
Power	13
Battery Calibration	14
Configuring the Touchpanel	15
General Use and Safety	28
Recommended Cleaning	28
Programming Software	29
Earliest Version Software Requirements for the PC	29
Programming with Crestron SystemBuilder	29
Programming with SIMPL Windows	29
Programming with VisionTools Pro-e	31
Embedded Applications	35
Example Program	36
Uploading and Upgrading	37
Establishing Communication	37
Programs, Projects and Firmware	38
Program Checks	38
Problem Solving	40
Troubleshooting	40
Reference Documents	41
Further Inquiries	42
Future Updates	42
Software License Agreement	43
Return and Warranty Policies	46
Merchandise Returns / Repair Service	46
CRESTRON Limited Warranty	46

Isys i/O[®] 2.8" Handheld WiFi Touchpanel: TPMC-3X

Introduction

Simply stated, the TPMC-3X Handheld Wifi Touchpanel from Crestron[®] delivers the best remote control available for home theater and AV presentation, marrying style and ergonomics with the ultimate in performance and ease of customization. Its sleek form factor is easy to hold, with large tactile pushbuttons, electroluminescent backlighting and a fully customizable video touchscreen to provide a wireless control solution that is both intuitive and fun to use.

Features and Functions

- Sleek and ergonomic handheld design
- Stylish tabletop docking station
- Elegant gloss black finish
- Instant-Waking[™] behavior with tilt sensor
- Works like an IR remote - with all the benefits of 2-way RF
- High performance 802.11a/b/g Wi-Fi wireless communications
- 50 feet (~15 meters) omnidirectional RF range indoors*
- Supports roaming between multiple Wi-Fi access points
- Long lasting lithium polymer rechargeable battery pack
- Widely spaced tactile pushbuttons
- White EL backlit button text
- 2.8" (72 mm) active matrix color touchscreen display
- High display brightness and contrast
- Wide 150 degree viewing angle
- 16-bit Isys i/O[®] graphics
- 240 x 320 resolution
- Dynamic graphics and text capability
- Synapse[™] image rendering algorithm
- DNav dynamic menu objects
- Windows[®] SideShow[®] enabled
- Wireless video from network cameras and servers
- WAV file audio feedback
- Programmable via SystemBuilder[™] and Adagio[®] Composer software

* Range is subject to environmental conditions.

The Ultimate Handheld Remote

Gone are the limitations of previous generation remotes and the frustration of using them. The TPMC-3X offers seamless interaction with AV and environmental systems, providing true feedback of all your settings and displaying metadata information for all your digital media. Whether watching TV, choosing a movie or music title, adjusting room temperature and lighting, checking the security system or even monitoring live video right on the built-in touchscreen, the TPMC-3X affords a user experience like no other handheld remote.

Wi-Fi Performance – Redefined!

Crestron has redefined Wi-Fi wireless performance with the TPMC-3X, achieving a remarkable 50 feet (~15 meters) omnidirectional coverage indoors (subject to environmental conditions), providing exceptional freedom of movement without line-of-sight or even having to be in the same room. The TPMC-3X also supports roaming* among multiple access points for extended coverage. The choice of 802.11a,b and g protocols affords reliable, high speed 2-way wireless performance in virtually any RF environment. A network of one or more TPMC-3Xs can be set up in minutes using a Crestron CEN-WAP-ABG-1G or CEN-WAP-ABG-CM Wireless Access Point (both sold separately).

* For more information about roaming, please contact Crestron customer support.

Instant-Waking™

To ensure the most transparent user experience possible, the TPMC-3X has been engineered to wake instantly at the press of a button, touch of the touchscreen or by simply tilting the remote upright. Button presses are sent immediately just like an IR remote but with none of IR's limitations. So spontaneous actions like muting the audio, pausing the video or changing the channel can be executed on the fly with just a single button press.

Extended Battery Life

Instant waking also allows the TPMC-3X to be put to sleep within seconds of putting it down, helping to extend its battery life for several days of typical usage on a single charge. Even under continuous use at full brightness, the TPMC-3X lasts an incredible five hours. Its fast charging, field replaceable lithium polymer battery pack delivers optimum power in a very small, lightweight package.

Tactile Pushbuttons with Backlit Text

A complement of 27 tactile pushbuttons makes for a very intuitive user interface, providing easy access to everything needed for watching TV and movies, listening to music and controlling the entire room. Large, widely spaced buttons accommodate hands and fingers of all sizes, minimizing the chance of an unintended button press. Backlit button text affords excellent legibility for use in a darkened room.

The pushbuttons are comprised of 17 buttons designated for the most common functions, a 5-way navigation pad, three context assignable "hard keys" beneath the touchscreen, a thumb operated "More" button for advancing through the available touchscreen pages and a system power button. Every button on the TPMC-3X is fully programmable to allow precisely the control desired, whether simply adjusting audio volume and flipping through channels, controlling a DVR or DVD player, navigating onscreen setup menus or operating a pan/tilt camera.

Handheld Touchpanel Control

Custom touchpanel versatility is afforded through a brilliant 2.8" (72 mm) active matrix touchscreen displaying stunning 16-bit color graphics and video. Dynamic graphics and text capability enable the display of all kinds of useful data and alluring eye candy, from channel preset icons, to room temperature and lighting levels, to photos and video, to digital media playlists complete with metadata and cover art.

Crestron exclusive DNav and Synapse™ technologies enable system programmers to produce amazing graphics faster and easier, using advanced dynamic control menus and 3D effects. Full motion animations, multimode objects, PNG translucency, transition effects and streaming video enhance the palette for creating GUIs that are both eye catching and easy to use.

Support for Windows® SideShow® gives the TPMC-3X access to all kinds of PC and Web-based content such as news feeds, sports scores, stock tickers, weather alerts, media guides, appointment notifications and email messages all through a simple network connection to a Windows® computer.

Wireless Video

Its built-in streaming video player makes it possible to monitor a security camera or preview a DVD or television channel, right on the touchscreen display. Native support for MJPEG streaming allows the TPMC-3X to display live video from a variety of Web cameras and servers including the Crestron CEN-NVS100 Network Video Streamer (sold separately).

Audio Feedback

Customized WAV files can be loaded on the TPMC-3X to add dimension to its touchscreen graphics using personalized sounds, button feedback and voice prompts.

TableTop Docking Station/Charger

The TPMC-3X makes an elegant statement in any room, especially when placed on its stylish docking station/charger (model TPMC-3X-DS, included). When docked, the touchpanel sits at the ready, able to be used as a stationary tabletop controller while charging. The docking hook incorporates a magnetic catch, ensuring secure attachment while docked and an effortless transition between docked and handheld use. The sleek, low profile base is weighted for excellent stability on any flat surface. An optional wall mount docking station is also available (model TPMC-3X-DSW, sold separately).

Applications

The following diagram illustrates a basic configuration that connects a TPMC-3X WiFi touchpanel to a control system via a wireless access point (WAP).

TPMC-3X in a Simple Network

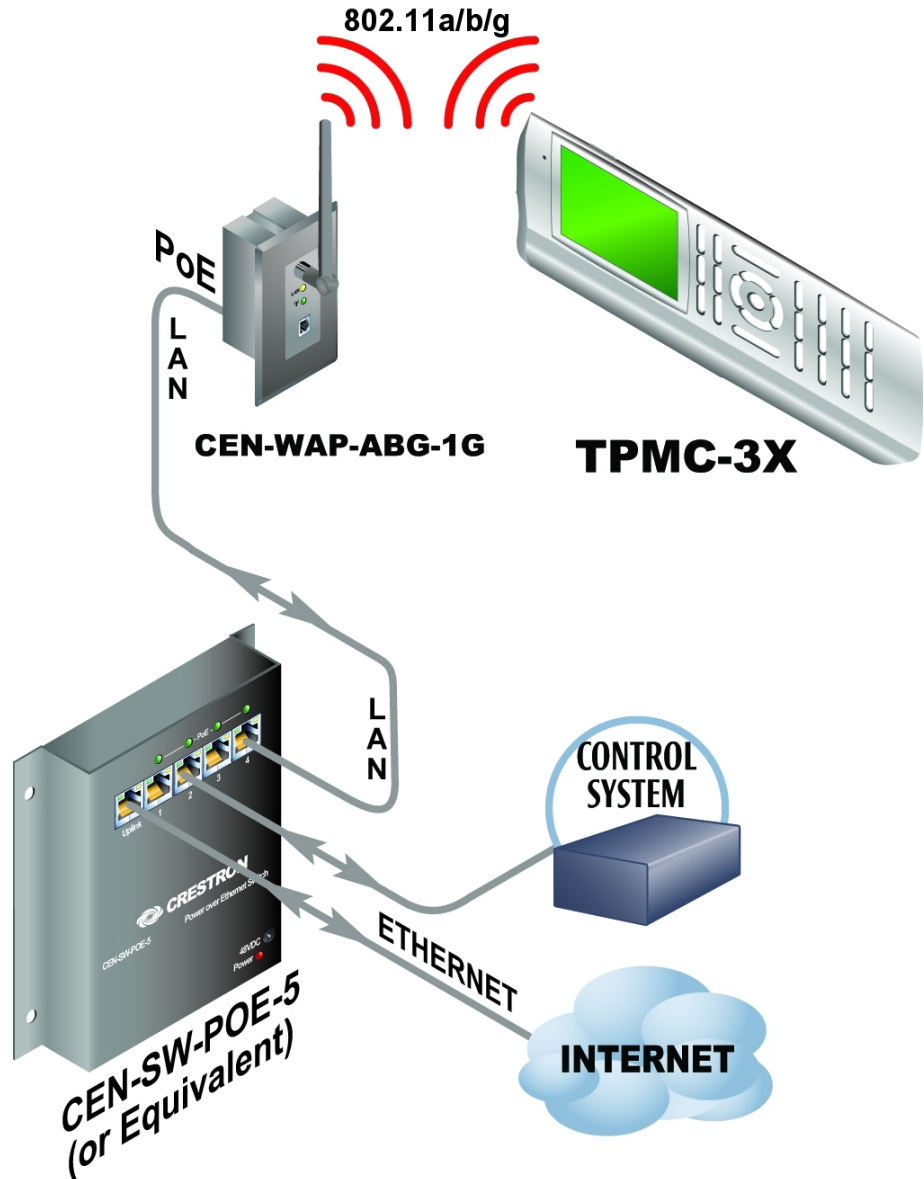

The distance between the TPMC-3X and the CEN-WAP-ABG-1G (or CEN-WAP-ABG-CM) should not exceed 50 feet (~15 meters).

The following diagram presents a more complex configuration. In this scenario, the WAP is connected to a port on the control system's C2ENET-2 card. The other port is connected to the corporate LAN. The card's internal firewall controls data flow, thus isolating the two subnets.

NOTE: When using a dual-port Ethernet card, Ports A & B must be different subnets (e.g., Port A = 128.x.x.x; Port B = 192.x.x.x).

For additional information on setting up and understanding an Ethernet network, refer to the latest version of the Crestron e-Control Reference Guide (Doc. 6052).

TPMC-3X with Multiple Networks

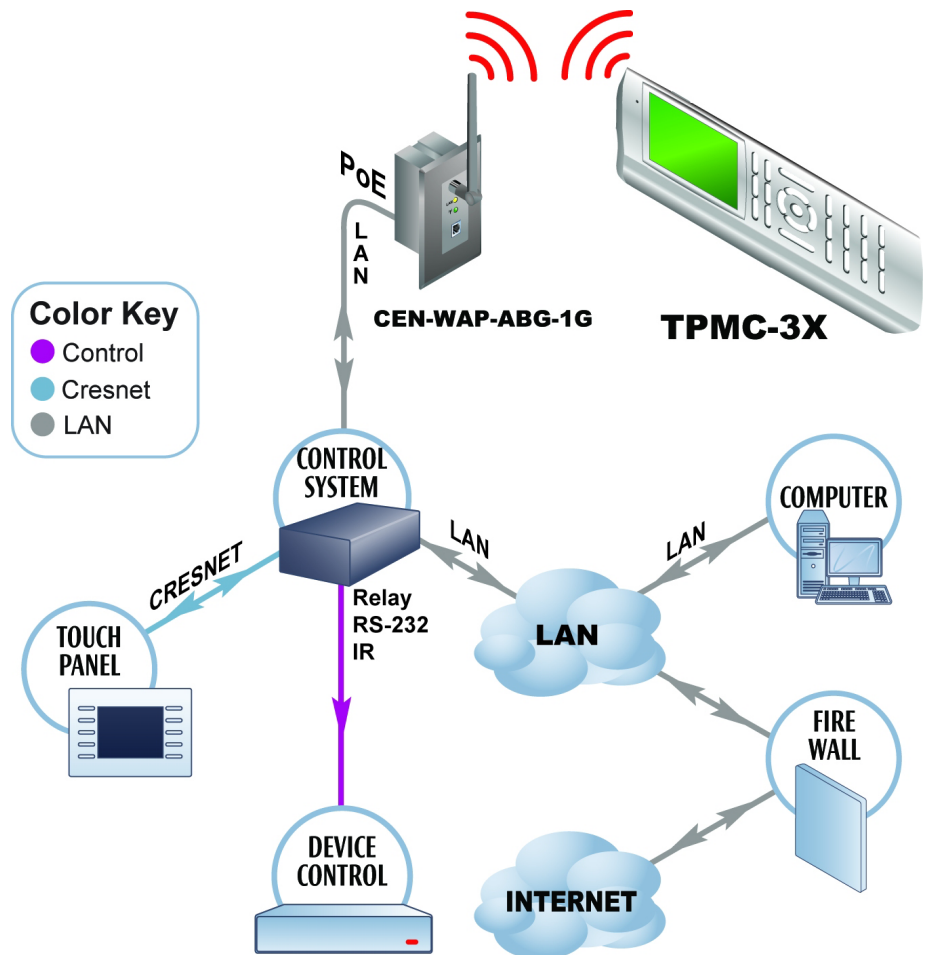

Specifications

Specifications for the TPMC-3X are listed in the following table.

TPMC-3X Specifications

SPECIFICATION	DETAILS
Touchscreen Display	
Display Type	Transflective TFT active matrix color LCD
Size	2.8 inch (72 mm) diagonal
Aspect Ratio	3:4 QVGA (portrait orientation)
Resolution	240 x 320 pixels
Brightness	350 nits typical
Contrast	500:1 typical
Color Depth	16-bit, 64k colors
Viewing Angle	±75° horizontal, +75°/-55° vertical
Illumination	LED backlit
Touchscreen	Resistive membrane
Memory	
SDRAM	128 MB
Flash	256 MB
Maximum Project Size	24 MB
Graphic Engine	Isys i/O® engine, 16-bit non-palette graphics; 65,536 colors; Synapse™ image rendering algorithm; multi-mode objects; DNav dynamic menu objects; dynamic graphics and text; Windows® SideShow® support; PNG translucency; full motion (60 fps) animation; transition effects
Embedded PC Applications ¹	Crestron MJPEG Viewer
RF Wireless	
RF Transceiver	IEEE 802.11a/b/g Wi-Fi, 5.8 or 2.4 GHz 2-way RF, static IP or dynamic IP via DHCP, 64 and 128-bit WEP encryption, WPA and WPA2-PSK with TKIP and AES
Range	50 feet (~15 meters), subject to environmental conditions, supports roaming among multiple access points
Gateway	Requires a CEN-WAP-ABG or similar 802.11a/b/g wireless access point and Ethernet enabled Crestron 2-Series control system (all sold separately)
Video	
Streaming Formats	MJPEG via Crestron MJPEG Viewer, with support for Crestron CEN-NVS100 Network Video Streamer (sold separately)
Audio	
Hardware Features	Built-in speaker
Audio Feedback (WAV)	8 and 16-bit PCM, mono & stereo, 8-44.1kHz sampling rates

(Continued on following page)

TPMC-3X Specifications (Continued)

SPECIFICATION	DETAILS
Tilt Sensor	Wakes touchpanel within 0.5 seconds when unit's physical orientation is moved from horizontal to vertical
Battery	
Battery Type	Lithium polymer, 3.7 Volt, 1000 mAh (included)
Usage per Charge	5 hours continuous at full brightness
Charging Time	2 hours
Cycle Life	>300 cycles (80% capacity)
Power Requirements	
TPMC-3X-DS Docking Station/Charger (included)	1.5 Amps @ 12 Volts DC
Power Supply (included)	0.6 Amps @ 100-240 Volts AC, 50-60 Hz
Default IP ID	03
Minimum 2-Series Control System Update File ^{2,3}	Version 3.155.1240 or later
Environmental	
Temperature	32° to 104° F (0° to 40° C)
Humidity	10% to 90% RH (non-condensing)
Heat Dissipation	5 BTU/Hr
Enclosure	
Construction	Plastic, integral docking station port
Dimensions	
Height	1.04 in (27 mm) 6.34 in (161 mm) docked
Width	2.55 in (65 mm) 4.58 in (117 mm) docked
Depth	7.94 in (202 mm) 6.30 in (160 mm) docked
Weight	7 oz (187 g)
Included Accessories	
Power Supply	Input: 100-240 VAC 0.6A 50/60 Hz, Output: 12 Volt DC, 1.5A
TPMC-3X-BTP	Internal Battery Pack
TPMC-3X-DS	Docking Station/Charger
Available Accessories	
CEN-WAP-ABG-1G	802.11a/b/g Wireless Access Point, Wall Mount
CEN-WAP-ABG-CM	802.11a/b/g Wireless Access Point, Ceiling Mount
TPMC-3X-DSW	Wall Mount Docking Station/Charger

1. Refer to website or contact Crestron for a current list of embedded applications. To ensure reliable performance, new applications are available only from Crestron through firmware updates.
2. The latest software versions can be obtained from the Crestron website. Refer to the NOTE following these footnotes.
3. Crestron 2-Series control systems include the AV2 and PRO2. Consult the latest Crestron Product Catalog for a complete list of 2-Series control systems.

NOTE: Crestron software and any files on the website are for authorized Crestron dealers and Crestron Authorized Independent Programmers (CAIP) only. New users may be required to register to obtain access to certain areas of the site (including the FTP site).



Battery must be recycled. Deliver the battery to an appropriate recycling facility.

Physical Description

This section provides information on the connections, controls and indicators available on your TPMC-3X.

TPMC-3X Physical View



TPMC-3X Overall Dimensions (Front and Side Views)

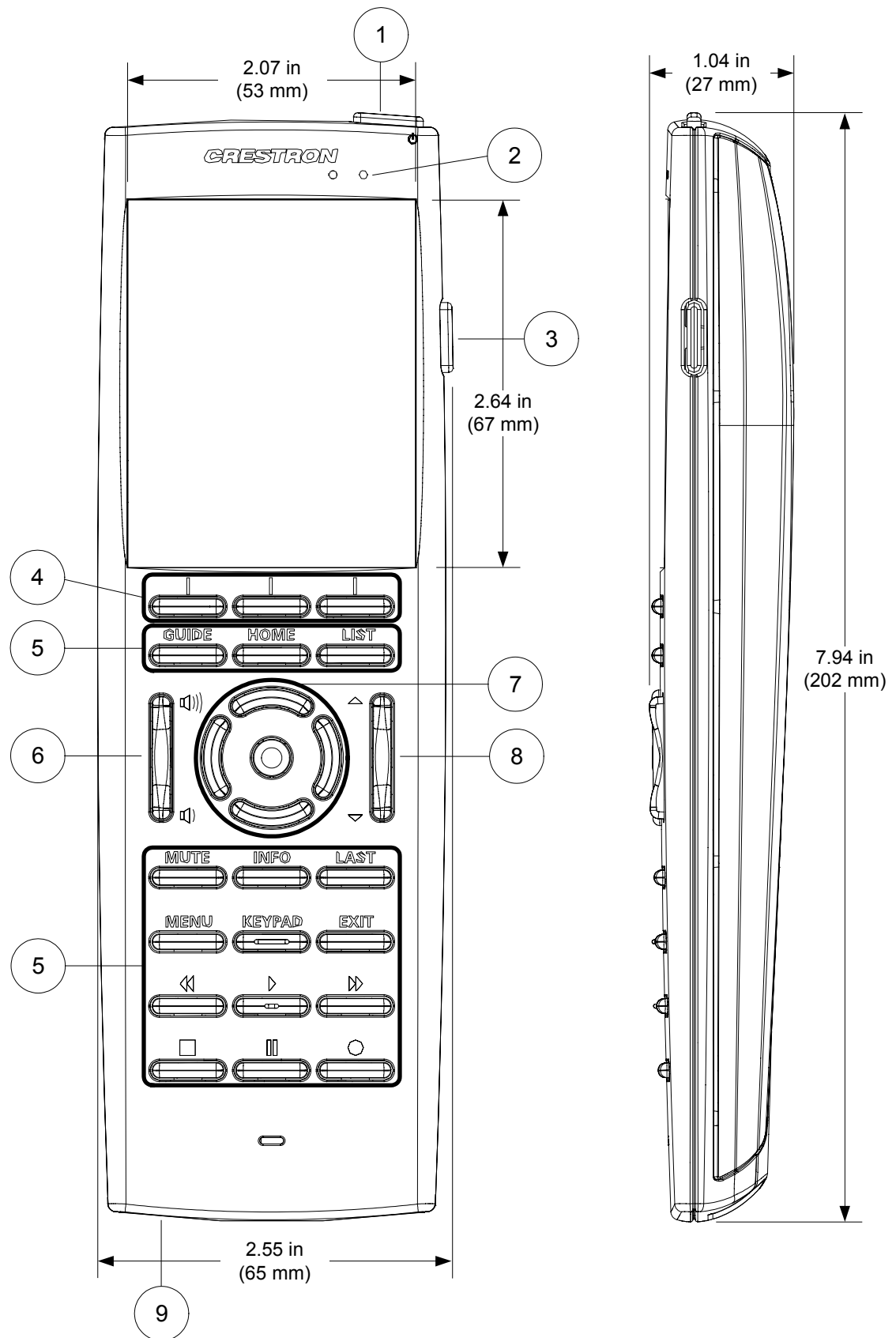

TPMC-3X-DS Docking Station/Charger Dimensions (Front, Side, Rear and Bottom Views)

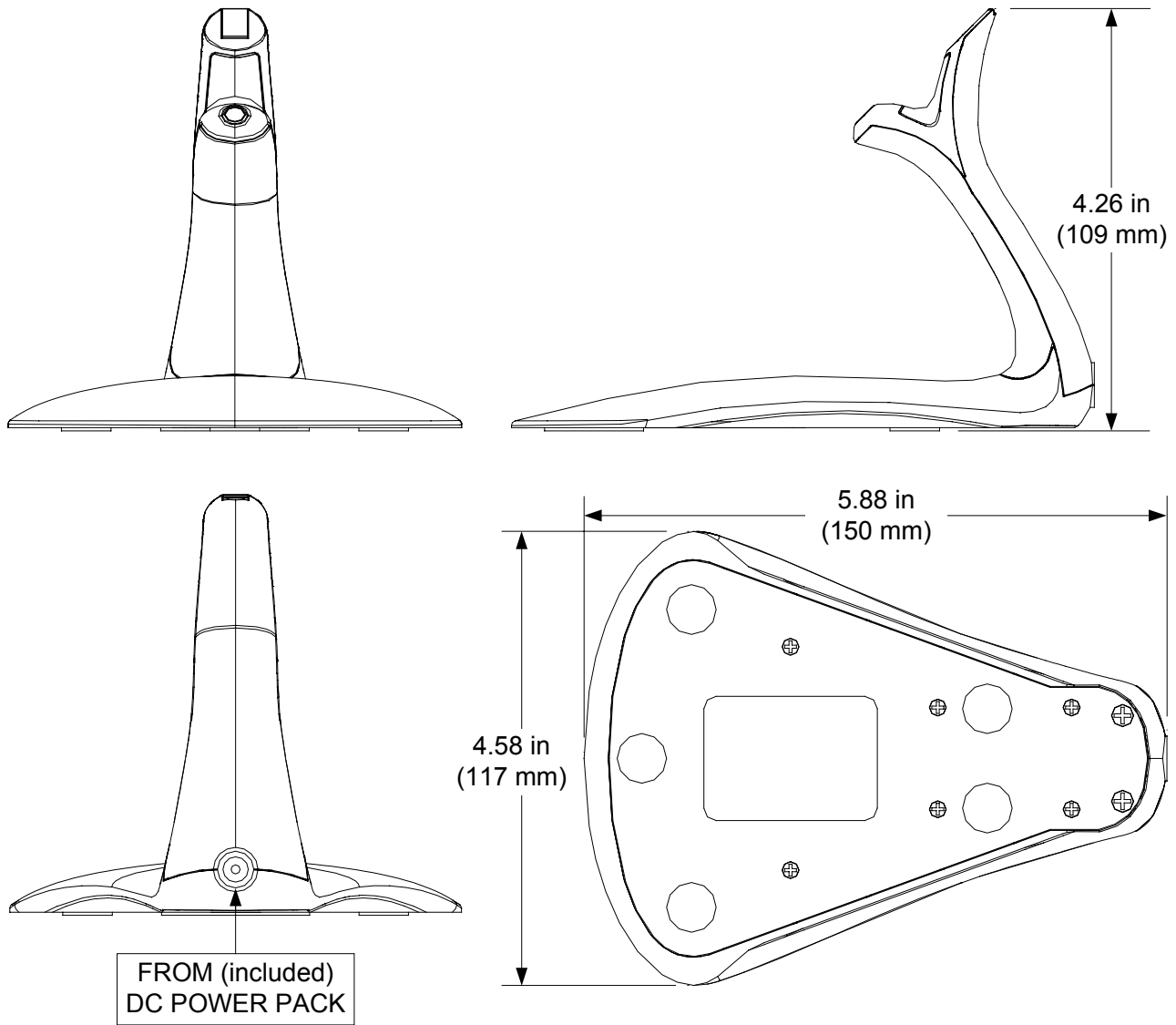

Connectors, Controls & Indicators

#	CONNECTORS ¹ , CONTROLS & INDICATORS	DESCRIPTION
1	Power (top)	(1) Programmable pushbutton, performs hardware reset if held for >10 seconds
2	Charge	(1) Green LED, indicates charging status when docked
3	More (right side)	(1) Programmable thumb operated side button
4	Hard Keys	(3) Programmable pushbuttons below touchscreen
5	Functions	(15) Programmable pushbuttons with white backlit labeling for GUIDE, HOME, LIST, MUTE, INFO, LAST, MENU, KEYPAD, EXIT and icons for Rewind, Play, Forward, Stop, Pause, Record
6	Volume	(1) Programmable rocker button with white backlit volume "Raise" and "Lower" icons
7	Navigation Pad	(5) Programmable pushbuttons comprising a 5-way thumbpad (4-way navigation plus "Enter")
8	Up/Down	(1) Programmable rocker button with white backlit "Up" and "Down" arrows
9	USB* (bottom)	(1) Mini Type AB female (behind battery cover); USB 1.1 computer console port, cable included

* USB port is for installer use only.

Setup

Identity Code

The IP ID is set within the TPMC-3X's table using Crestron Toolbox™. For information on setting an IP table, refer to the Crestron Toolbox help file. The IP IDs of multiple TPMC-3X devices in the same system must be unique.

When setting the IP ID, consider the following:

- The IP ID of each unit must match an IP ID specified in the SIMPL™ Windows program.
- Each device using IP to communicate with a control system must have a unique IP ID.

Battery Installation

Perform the following procedure to install the TPMC-3X-BTP battery pack in a TPMC-3X touchpanel:

1. Place the touchpanel screen side down on a clean, soft surface.
2. Remove the battery compartment cover on the rear of the touchpanel.
3. Carefully connect the multi-pin connector of the TPMC-3X-BTP with the corresponding connector inside the battery compartment. The pin side of the connector should be facing upward (toward the rear of the touchpanel). Red wires should be above black wires (toward the top of the touchpanel). Ensure the connector is fully seated.
4. Place the TPMC-3X-BTP in the battery compartment, oriented so the wires for the multi-pin connector are on the bottom. Refer to the photo on the following page.

TPMC-3X-BTP in Battery Compartment of TPMC-3X

5. Re-attach the battery compartment cover.

Power

To charge its internal battery pack, the TPMC-3X must be placed on the included TPMC-3X-DS docking station/charger. Connect the included power pack to the TPMC-3X-DS docking station/charger.

NOTE: Before using the TPMC-3X for the first time, charge its internal battery for at least two hours by placing on the TPMC-3X-DS docking station/charger. The green LED on the front of the TPMC-3X will blink while the battery is charging.

It takes the TPMC-3X about two hours to recharge while in use. A fully charged battery can provide up to five hours of use at the full screen brightness setting.

The TPMC-3X has a removable battery pack. With a properly maintained battery, the design should retain 80% of its original capacity at 300 full charge and discharge cycles. You may choose to replace your battery when it no longer holds sufficient charge to meet your needs.

NOTE: When not using the TPMC-3X, store the unit on its docking station/charger.

NOTE: The TPMC-3X can become unresponsive when battery strength is low.

Battery Calibration

For optimum performance after shipping or any time the unit's power has been off for an extended period of time, Crestron recommends the following procedure be performed:

1. Place the unit on its docking station/charger and connect AC power.
2. Allow the unit to charge completely. (The green LED should be steady on for 15 minutes.)
3. Remove panel from the docking station/charger.
4. From the main setup screen, touch **Diagnostics**, then touch **Battery Diags** to go to the *Battery Diagnostics* screen. Touch **Recondition Battery**, then touch **YES, Recondition Battery** to confirm. (Refer to "Configuring the Touchpanel" which starts on page 15.)
5. Wait for the unit to shut off. This takes approximately five hours. Leave the unit off the dock the entire time. During this operation, the *Battery Reconditioning* screen shown on page 25 will be displayed until the unit shuts off.
6. Place the unit back on the docking station and allow it to charge completely.
7. Unit is now ready for normal operation.

Configuring the Touchpanel

When power is applied to the unit for the first time, the following screen appears.

Initial Opening Screen



Touch the screen to display the following TPMC-3X setup screen.

Setup Screen



The setup screen enables basic configuration procedures prior to regular operation of the touchpanel.

NOTE: During regular operation of the touchpanel, there are three ways to activate the setup functions:

1. Place a button on the project main page and assign the reserved join number (17242) that activates setup.
2. Press hard keys 1, 2, 3, and 4 in sequence twice (i.e. press 1, 2, 3, 4, 1, 2, 3, 4) within a five second period. For hard key locations, refer to “Pushbutton Programming” on page 34.
3. If the system bar is visible at the top of the display, you can also access the setup screen by touching the Crestron swirl logo in the upper left corner.

Indicators

The top of the setup screen contains the system bar, which includes bar graph indicators for battery strength and Wi-Fi signal strength.

Panel Setup Options

These setup options control the basic operation of the TPMC-3X.

WiFi Setup

Touch **WiFi Setup** to display information about your WiFi *Signal Strength*, *WAP Connection*, *Control Connection*, *MAC* address, *IP* Address and to gain access to the **IP Config**, **WiFi Access Point**, **CtrlSys IP Address** and **Performance Options** screens. Touch **Back** to return to the main setup screen.

WiFi Setup Screen

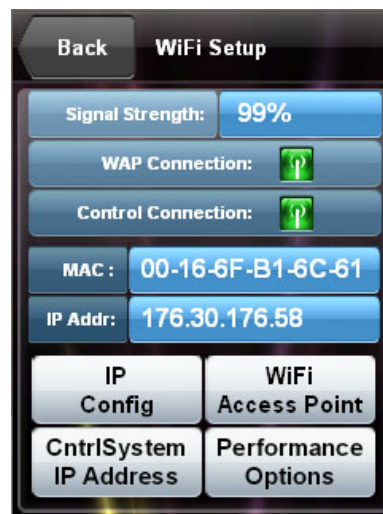

NOTE: It may take 5-10 seconds for the IP address to show once the *WAP Connection* indicator has turned green.

When you enter the screens for **WiFi Access Point**, **CtrlSystem IP Address** and **IP Config**, you will find a keyboard application at the bottom of each screen. The keyboard uses the navigation pad (up, down, left and right) to select a character to type. The center button on the navigation pad will type the selected character.

On-screen Keyboard



There are different characters in each row. You can move between rows using the up/down buttons and move within a row using the left/right buttons.

There are a few “shortcut” keys: The top six hard keys are mapped according to the legend at the bottom of the screen (*BSpC*, *Tab>>*, *Delete*, *OK*, *<<Tab* and *Cancel*).

The volume up/down and ▲/▼ keys on either side of the navigation pad also have some shortcuts to help navigate around text and list boxes. The volume up/down

buttons act as the up and down arrow keys (use to select items in a list box). The ▲ and ▼ buttons can be used to move the cursor within a text string.

WiFi Access Point

From the *WiFi Setup* screen, touch **WiFi Access Point** to display the *Wireless Information* screen, which allows you to set up the parameters used to communicate with the control system via a wireless access point (WAP). Crestron recommends using a dedicated CEN-WAP-ABG-1G or CEN-WAP-ABG-CM (both sold separately) for each TPMC-3X in the system.

Wireless Information Screen

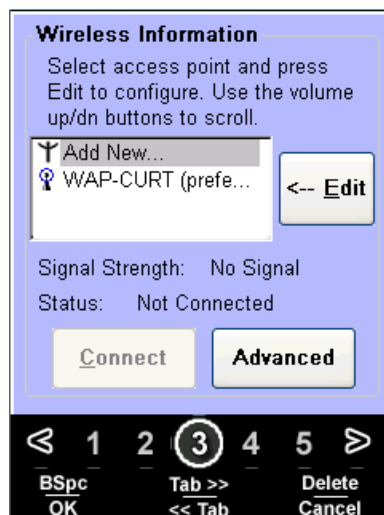

A list of available access points is shown. Use the volume up/down buttons to scroll through the list. Select the access point and touch **Edit** to configure. With DHCP enabled, simply enter your *Network key*.

Touch the appropriate hard key for *Tab>>* or *<<Tab* to navigate editable fields. Touch the appropriate hard key for *OK* to save settings or for *Cancel* to exit without saving.

Wireless Information Editing Screen

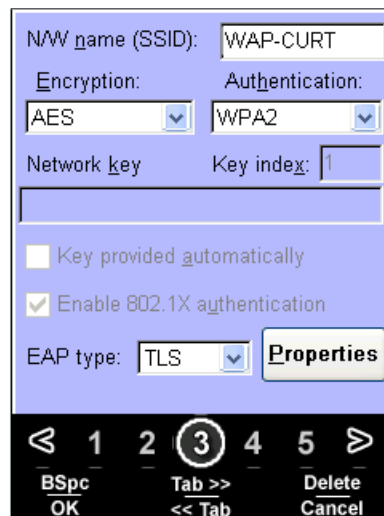

From the main Wireless Information screen, touch **Advanced** to access the *Advanced Wireless Information* screen.

Advanced Wireless Information Screen

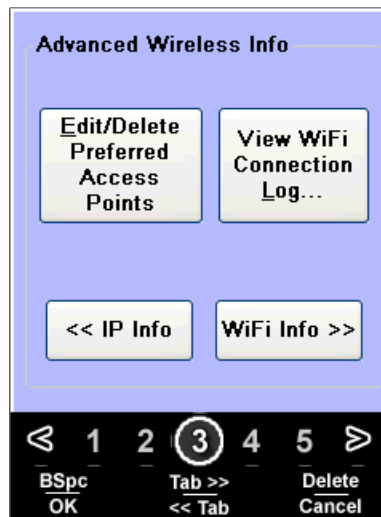

This screen allows you to **Edit/Delete Preferred Access Points**, **View WiFi Connection Log...** and also to view **<< IP Info** and **WiFi Info >>**.

CntrlSystem IP Address

From the *WiFi Setup* screen, touch **CntrlSystem IP Address** to display the *Control System Information* screen, which allows you to *Enable Autodiscovery* and *Use Hostname Lookup* as well as enter the *IP Address*, *Port* and *IP ID*.

Touch the appropriate hard key for *Tab>>* or *<<Tab* to navigate editable fields. Touch the appropriate hard key for *OK* to save settings or for *Cancel* to exit without saving.

NOTE: The control system connection may not be made until you exit setup.

Control System Information Screen

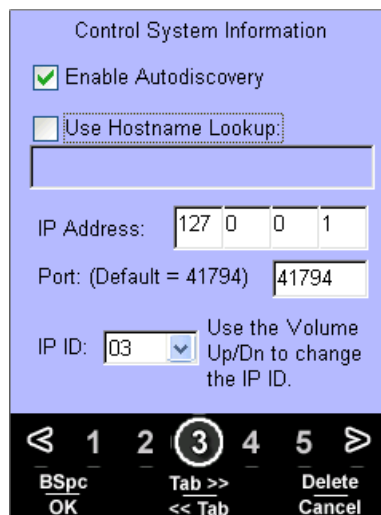

IP Config

From the *WiFi Setup* screen, touch **IP Config** to display the *IP Settings* screen.

You can select **USE DHCP** to automatically assign an IP address or you can select **USE STATIC**, which allows you to manually enter an *IP Address*, *Subnet Mask* and *Gateway*.

The TPMC-3X ships with DHCP enabled by default.

IP Settings Screen

If you are using a static IP address, touch **DNS Servers** to enter the DNS Servers screen. Here, you can enter a specific *Main DNS*, *Alternate DNS*, *Main WINS* and *Alternate WINS*. Touch **IP Settings** to return to the *IP Settings* screen.

Touch the appropriate hard key for *Tab>>* or *<<Tab* to navigate editable fields. Touch the appropriate hard key for *OK* to save settings or for *Cancel* to exit without saving.

DNS Servers Screen

Performance Options

From the *WiFi Setup* screen, touch **Performance Options** to display the *Performance Options* screen, where you can select **High Performance Mode** or **Extended Battery Life Mode**.

Performance Options Screen

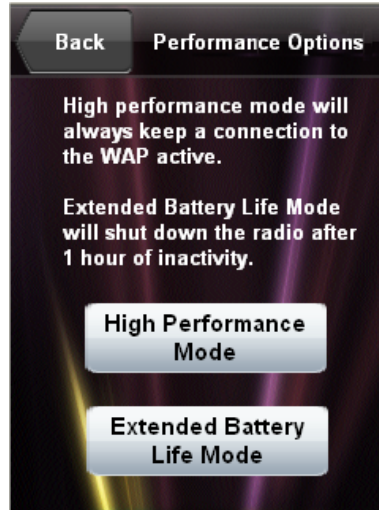

Audio Setup

Touch **Audio Setup** to display the *Audio Settings* screen, with controls for *Master Volume* and *Mute* as well as buttons providing access to the **Key Click Settings** and **Wav Settings** screens. Touch **Back** to return to the main setup screen.

Audio Settings Screen

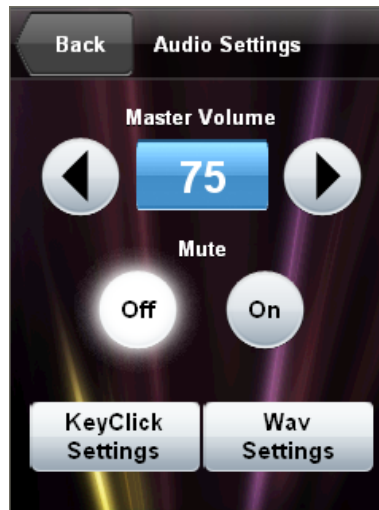

Key Click Settings

Touch **Key Click Settings** to enter the *Key Click Settings* screen, which has controls for *Key Click Volume* and *Mute*, as well as controls to turn the key click sound that occurs when the panel is docked on or off. Touch **Back** to return to the *Audio Settings* screen.

Key Click Settings Screen



Wav Settings

Touch **Wav Settings** to enter the *Wav Settings* screen, which has controls for *Wav Volume* and *Mute* as well as a **Play Test Wav** button. Touch **Back** to return to the *Audio Settings* screen.

Wav Settings Screen



Standby Setup

Touch **Standby Setup** to enter the *Standby Timeouts* screen, which has controls for adjusting standby timeout when the TPMC-3X is docked and undocked, as well as a **Power Off** timeout when the touchpanel is undocked. Touch **Back** to return to the main setup screen.

Standby Timeouts Screen

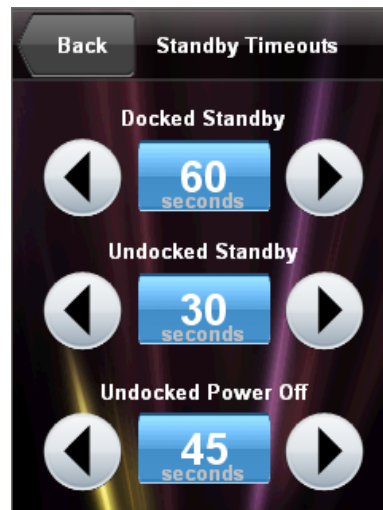

Diagnostics

Touch **Diagnostics** to enter the *Diagnostics* screen. This screen will display *Total RAM*, *Free RAM* and provide buttons for access to other screens, such as **Keypad Test**, **Touch Test**, **WiFi Diags**, **Battery Diags**, **Tilt Test** and **Test Mic**. Touch **Back** to return to the main setup screen.

Diagnostics Screen

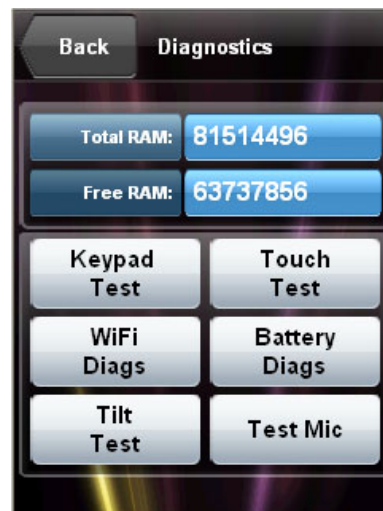

Keypad Test

Touch **Keypad Test** to view the *Keypad Test* Screen. Pressing the corresponding button on the TPMC-3X will cause its likeness on the screen to light up. Touch **Back** to return to the *Diagnostics* screen.

Keypad Test Screen



Touch Test

From the *Diagnostics* screen, the **Touch Test** button takes you to a screen for calibrating the TPMC-3X touchscreen. Touch **Calibrate** to begin screen calibration.

The calibration screen will show a crosshair in the center. Touch the crosshair and it will move to another location on the screen. Continue to touch the crosshair as it appears at each new location. When the process is finished, a "Calibration Complete" message will appear. Touch the screen to return to the Touch Test screen. Then touch **Return** to go back to the *Diagnostics* screen.

Touch Test Screen



WiFi Diags

From the *Diagnostics* screen, touch **WiFi Diags** to enter the *WiFi Diagnostics* screen, which displays *SSID*, *BSSID*, *RSSI*, *Signal Strength*, *MAC Connection* and *IP Addr* and has indicators for *WAP Connection* and *Control Connection*. Touch **Back** to return to the *Diagnostics* screen.

WiFi Diagnostics Screen

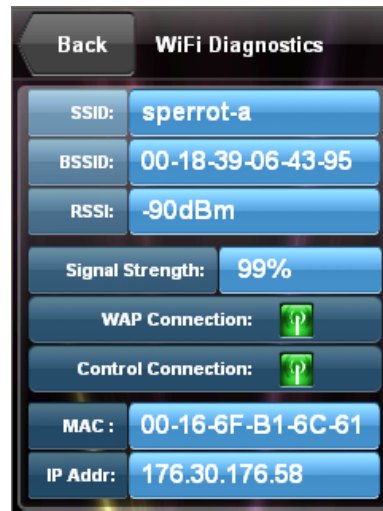

Battery Diags

From the *Diagnostics* screen, touch **Battery Diags** to enter the *Battery Diagnostics* screen. This screen displays the battery's state (e.g. charging), level (in percent), amount of current remaining and amount of voltage remaining. In addition, it contains controls to **Reset Battery Gauge** and **Recondition Battery**. Touch **Back** to return to the *Diagnostics* screen.

NOTE: The field at the bottom of the screen is to be used when under the supervision of a Crestron technical support representative during telephone support.

Battery Diagnostics Screen



Touch **Reset Battery Gauge** to recalibrate the battery gauge. The *Confirm Reset* screen will appear. Touch **YES, Reset Gauge** to reset the gauge or touch **Back** to return to the *Battery Diagnostics* screen.

NOTE: The gauge should be reset after any battery replacement.

Confirm Reset Screen



Touch **Recondition Battery** to drain and recondition the TPMC-3X's battery. The *Confirm Recondition* screen will appear.

Confirm Recondition Screen

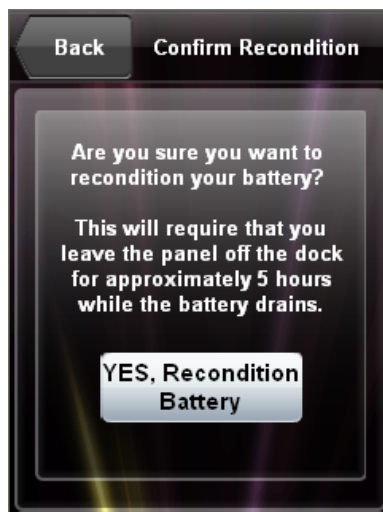

Touch **YES, Recondition Battery** to start the process. The *Battery Reconditioning* screen will appear.

Battery Reconditioning Screen

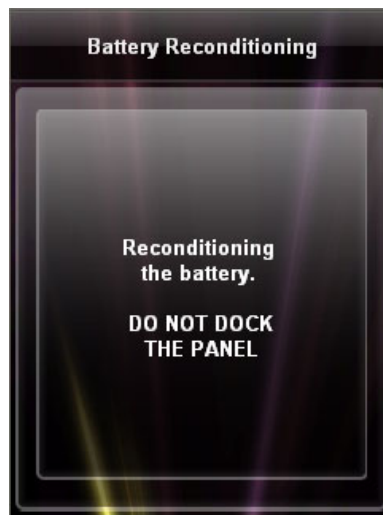

Tilt Test

From the *Diagnostics* screen, touch **Tilt Test** to enter the *Tilt Sensor Test* screen. The text in the box should change from *Flat* to *Tilt* when the TPMC-3X is held upright and from *Tilt* to *Flat* when it is placed flat, for example on a desk.

This screen also contains *Tilt Wakes Panel* controls, which determine whether tilting the panel upright when power is off will turn power on and wake the panel.

NOTE: When the panel is in a standby condition (where just the display is off as opposed to power being off) tilting it upright will always wake the panel, regardless of the *Tilt Wakes Panel* selection.

Touch **Back** to return to the *Diagnostics* screen.

Tilt Sensor Test Screen



Test Mic

Touch **Test Mic** to start a microphone test. The panel will record audio from the built-in microphone for five seconds, then play back the recording.

System Msgs Enabled

From the main setup screen, touch **System Msgs Enabled** to permit display of system messages.

About

From the main setup screen, touch **About** to display a screen that shows software and OS version information. Touch **OK** to remove the *About* screen.

Brightness Options

These setup options control the appearance of the TPMC-3X.

LCD Settings

From the main setup screen, touch **LCD Settings** to enter the *Display Settings* screen, with controls for screen brightness when the TPMC-3X is docked and when it is undocked. Lower brightness settings extend battery life. This screen also allows you to turn the *Hardkey Wakes LCD* option **On** or **Off**. When **On**, pressing a hard key or tilting the panel will turn on the LCD display if the display is off. Touch **Back** to return to the main setup screen.

Display Settings Screen

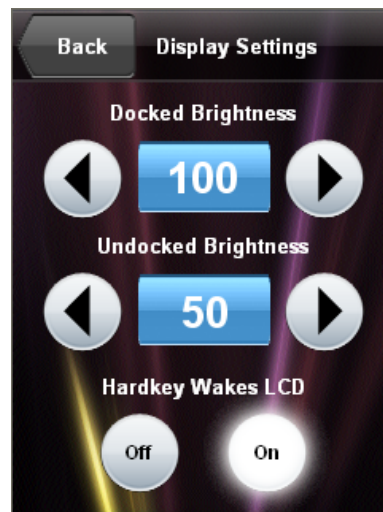

Keypad Settings

From the main setup screen, touch **Keypad Settings** to enter the *Keypad Settings* screen, with controls for keypad brightness when the TPMC-3X is docked and when it is undocked. Lower brightness settings extend battery life. This screen also provides a **Keypad Test** button, which is the same as the one described earlier. Refer to “Diagnostics” which starts on page 22. Touch **Back** to return to the main setup screen.

Keypad Settings Screen

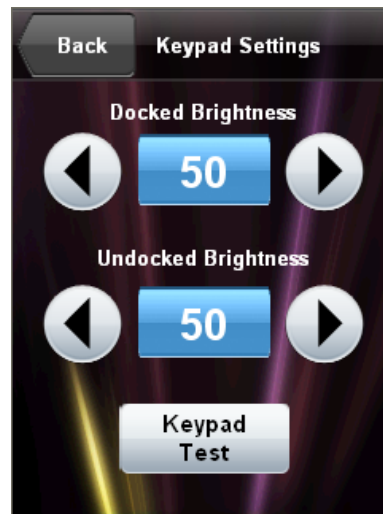

Save & Exit

From the main setup screen, touch **Save & Exit** to save any setup changes you have made and exit to normal operation mode.

General Use and Safety

WARNING: To avoid possible damage to the unit, do not use the touchpanel in the rain or expose to unnecessary moisture.

Recommended Cleaning

Keep the surface of the touchscreen free of dirt, dust or other materials that could degrade optical properties. Long-term contact with abrasive materials can scratch the surface, which may detrimentally affect image quality.

For best cleaning results, use a clean, damp, non-abrasive cloth with any commercially available non-ammonia glass cleaner. Bezels may not provide a complete watertight seal. Therefore, apply cleaning solution to the cloth rather than the surface of the touchscreen. Wipe touchscreen clean and avoid getting moisture beneath the bezels.

Programming Software

Have a question or comment about Crestron software?

Answers to frequently asked questions (FAQs) can be viewed in the Online Help section of the Crestron website. To post a question or view questions you have submitted to Crestron's True Blue Support, log in at <http://support.crestron.com>. First-time users will need to establish a user account.

Earliest Version Software Requirements for the PC

NOTE: Crestron recommends that you use the latest software to take advantage of the most recently released features. The latest software is available from the Crestron website.

Crestron has developed an assortment of Windows®-based software tools to develop a controlled system. For the minimum recommended software versions, visit the Version Tracker page of the Crestron website (www.crestron.com/versiontracker).

Programming with Crestron SystemBuilder

Crestron SystemBuilder is the easiest method of programming but does not offer as much flexibility as SIMPL Windows. For additional details, download SystemBuilder from the Crestron website and examine the extensive help file.

Programming with SIMPL Windows

NOTE: While SIMPL Windows can be used to program the TPMC-3X, it is recommended to use SystemBuilder for configuring a system.

SIMPL Windows is Crestron's premier software for programming Crestron control systems. It is organized into two separate but equally important "Managers".

Configuration Manager

Configuration Manager is the view where programmers "build" a Crestron control system by selecting hardware from the *Device Library*.

1. To incorporate the TPMC-3X into the system, drag the TPMC-3X from the Touchpanels | Touchpanels (Ethernet folder of the *Device Library* and drop it in the *System Views*.

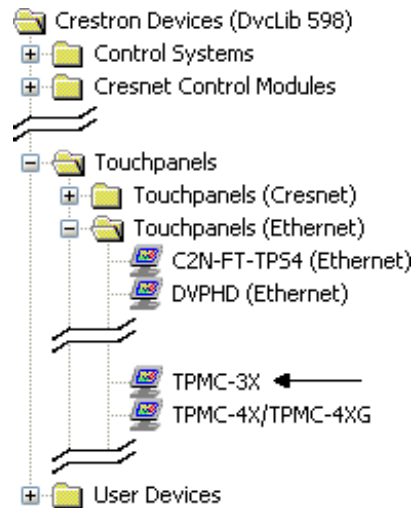
Locating the TPMC-3X in the Device Library

2. The system tree of the control system displays the device in the appropriate slot with an IP ID as shown in the following illustration.

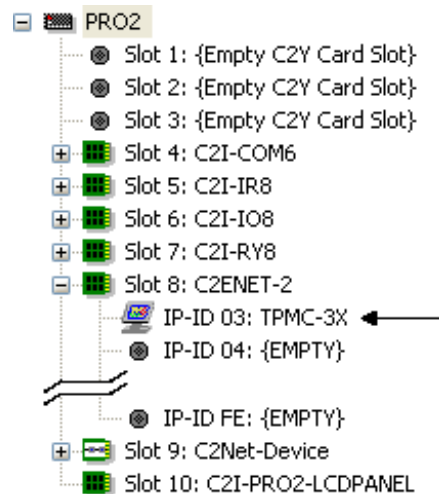
C2Net Device, Slot 8

3. Additional TPMC-3X devices are assigned different IP ID numbers as they are added.
4. If necessary, double click a device to open the “Device Settings” window and change the IP ID, as shown in the following figure.

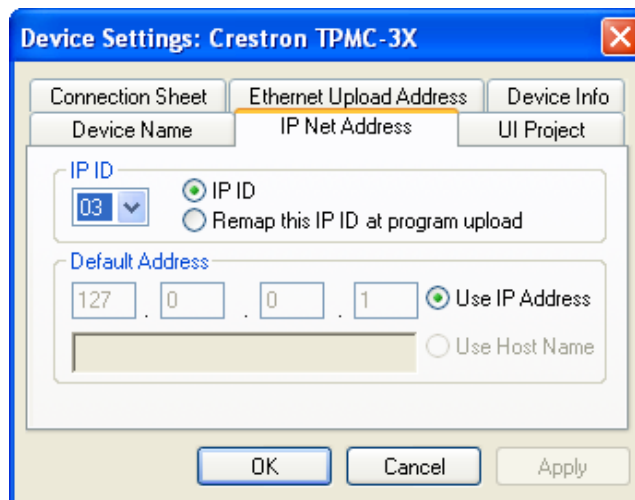
“Device Settings: Crestron TPMC-3X” Window

- The ID code specified in the SIMPL Windows program must match the IP ID of each unit.

Program Manager

Program Manager is the view where programmers “program” a Crestron control system by assigning signals to symbols.

The symbol can be viewed by double clicking on the icon or dragging it into *Detail View*. Each signal in the symbol is described in the SIMPL Windows help file (F1).

Programming with VisionTools Pro-e

Touchpanel screens should be created in VisionTools® Pro-e (VT Pro-e) to allow accessing the embedded applications, switching of source signals to desired outputs as well as selection of the system mode. There are no special programming requirements to use the functions of the TPMC-3X in a room control system.

Multi-Mode Objects

Multi-mode objects offer high-performance programming!

The single most advanced VT Pro-e high performance programming technique involving the TPMC-3X is the concept of multi-mode objects. A multi-mode object (i.e. button, legend, etc.) is an object drawn on a VT Pro-e page that can have one or more active and inactive visible settings (*modes*).

For examples, refer to www.crestron.com/exampleprograms and search for multi-mode object examples. This file contains the VT Pro-e touchpanel files and SIMPL Windows files that illustrate the high-performance capabilities of multi-mode objects.

WAV File Audio Messages

The TPMC-3X touchpanels are capable of playing audio messages as system prompts and responses. These files are recorded as WAV files on a PC using an audio utility such as Sound Recorder that is packaged with Microsoft Windows 95/98/Me/XP/NT/2000/Vista/7™. Files from other sources may also be converted to an acceptable format by using this or a similar utility. Many other audio utilities are available commercially or as shareware. The TPMC-3X touchpanels only accept the following WAV file formats: **PCM, 8 and 16 bit, 8 – 44.1kHz, mono and stereo**. For more information about how to use Sound Recorder, refer to its User’s Guide and extensive help information provided with the software. Also refer to the help file

in VT Pro-e to learn how to use its audio tool, Sound Manager, to attach WAV files to a touchpanel project.

Pre-recorded WAV files for voice prompts and responses are available from Crestron. These files can be stored into and programmed for use in the touchpanel directly or may be edited with the Sound Recorder. For example, the individual files can be combined to create custom messages.

NOTE: Touchpanel WAV files can be obtained from the Wave LC Library of the Crestron FTP site.

Bit Depth and File Size

A balance of performance and quality can be achieved by using VT Pro-e to configure the size of graphics in a project. Read this section to learn about bit depth and how to maximize the quality and performance of a TPMC-3X project.

Bit depth refers to the number of memory bits used to store color data for each pixel in a raster image. A touchpanel raster image consists of a rectangular grid of picture elements (pixels). Each pixel uses the same amount of memory to store its color data. The amount of memory is called the bit depth of the image.

Greater bit depths are required to represent finer gradations of color. Increasing bit depth necessarily increases file size. A black and white drawing requires only one bit per pixel to store all the available color information. Using a 32-bit per pixel bit depth for a black and white image increases the file size 32 times without adding anything to the black and white image quality.

In an 8-bit per pixel system, the associated 8-bits of video memory for every screen pixel contain a value referring to a location in an 8-bit color table. In this way any one of the specific 256 color table locations is assigned to a pixel.

A 16-bit highcolor system is considered sufficient to provide life-like colors. It is encoded using 5-bits to represent red, 5-bits to represent blue and (since the human eye is more sensitive to the color green) 6-bits to represent 64 levels of green. These can therefore be combined to provide 65,536 mixed colors ($32 \times 32 \times 64 = 65,536$).

In a 24-bit graphics display, the video memory allocates 24 bits for each pixel on the screen enabling each pixel to take on any one of a possible 16.7 million colors. Each 24-bit value is composed of 8-bits for red, 8-bits for green and 8-bits for blue. These triplets of 8-bit values are also referred to as the red, green and blue color planes. A 24-bit image is actually composed of three component images which combine to create the truecolor picture. The reason this is called truecolor is that this is near the maximum number of colors the human eye is able to detect.

Truecolor images are sometimes represented by a 32-bit value. The extra 8-bits do not enhance the precision of the color representation but act as an alpha channel that represents pixel translucence. 32-bit truecolor has become popular on the computer desktop to provide effects such as translucent windows, fading menus and shadows.

In graphics intensive applications such as touchpanels, raising or lowering the color depth of the displayed graphics can achieve a balance of performance and quality. Lower color depths do not require as much frame buffer memory or display bandwidth, allowing them to be generated and displayed more quickly. Increasing color depth results in higher color quality at the expense of display speed and responsiveness. By using mostly 8-bit or 16-bit graphics and holding 32-bit graphics to a minimum (e.g. for a family photo, etc.), you can create a sophisticated project that will fit in the memory space provided and have the touchpanel remain very responsive.

Relationship of Bits to Colors

NUMBER OF BITS	NUMBER OF COLORS
1 bit	Black and White
2 bits	4 Colors
4 bits	16 Colors
8 bits	256 Colors
16 bits	65,536 Colors (Highcolor)
24 bits	16.7 million Colors (Truecolor)
32 bits	16.7 million Colors plus Transparency

When creating a VT Pro-e project you can elect to compress and reduce the image size in the “Page Properties” window for the entire page and/or perform the same function of reducing the image size using the “Image Properties” window. A reduction in image size will save a considerable amount of memory space for your project.

In VT Pro-e, the **Compress** checkbox permits the image to be compressed when compiling. The **16 Bits** checkbox converts a 24-bit or 32-bit image to 16 bits. This conversion to a 16-bit image may cause the loss of some subtle shading. To compensate for this, use the dithering to simulate the original shading. Check your image with each of the available dithering types to determine which will deliver the best quality image.

Dithering type selection can be accessed from the “Page Properties” or “Image Properties” windows in VT-Pro-e. Refer to the following illustrations.

VT Pro-e “Page Properties” Window – Bit Depth Selection

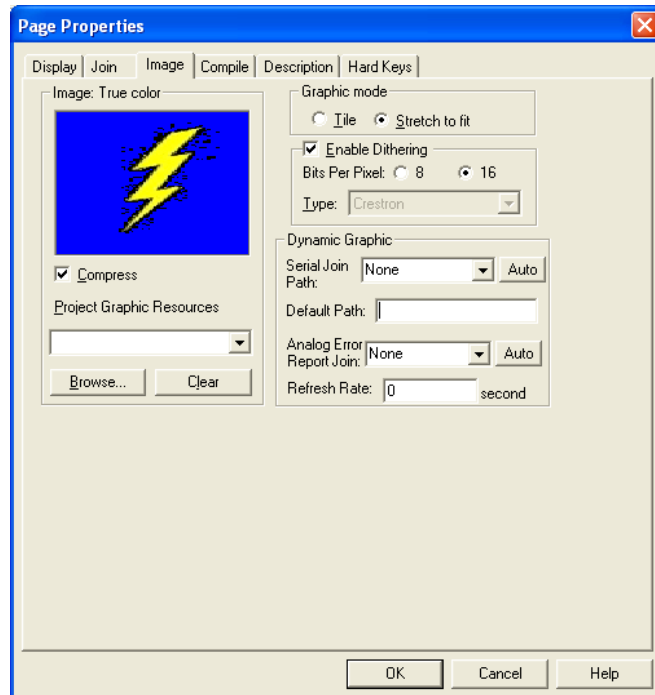

VT Pro-e “Image Properties” Window – Bit Depth Selection

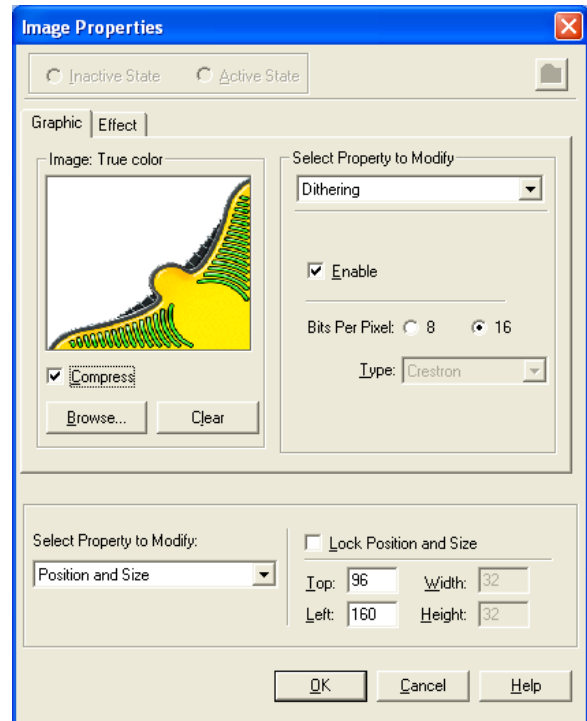

Pushbutton Programming

The buttons can be programmed to access any frequently used command. Refer to the following illustration for their default join numbers. A description for each button signal is described in the SIMPL Windows help file (**F1**).

Pushbutton Layout and Join Number Assignment

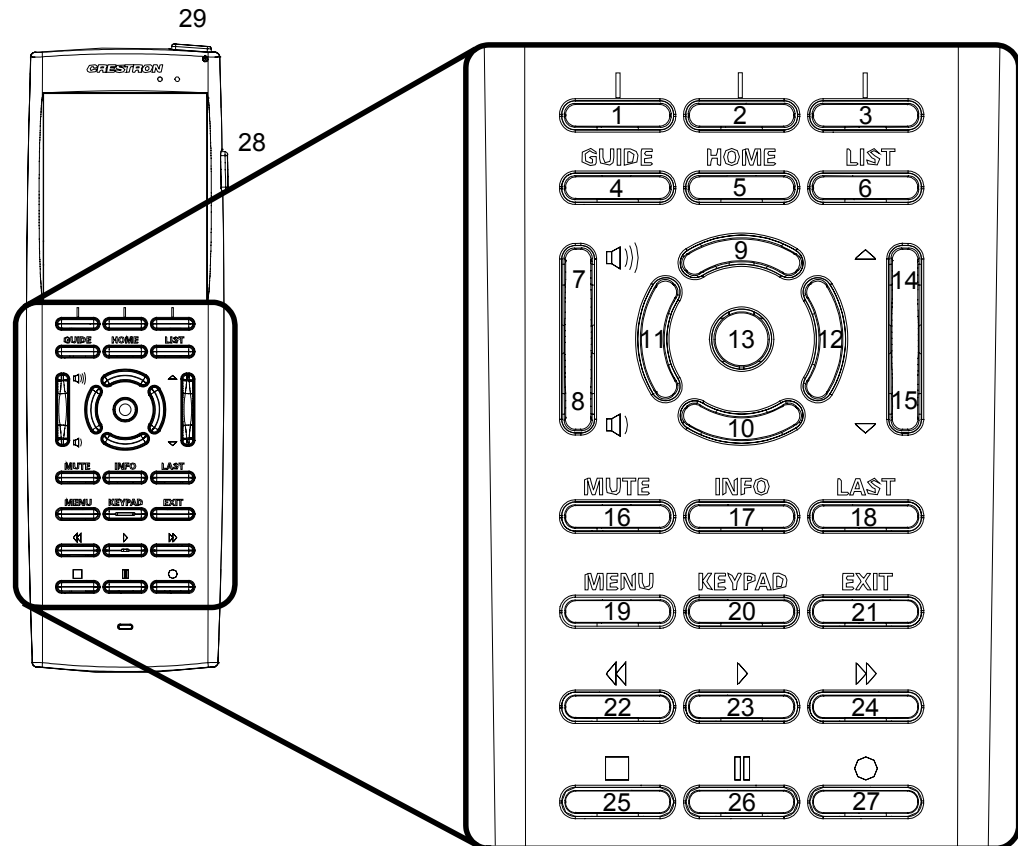

MultiByte International Characters

Most languages use a single byte of eight bits to represent a character, e.g. English, French, German, Hebrew, Russian, Thai, etc.

Multibyte character fonts require more than the usual eight bits to specify a character. This occurs when a language has more than 256 characters (2^8) in a font. For example, Chinese fonts contain several thousand characters. Other multibyte languages include Japanese and Korean.

There are two separate applications with multibyte characters – static text on buttons and indirect text on buttons. No Isys touchpanel firmware changes are required in either case.

Indirect text on a button is entered in VT Pro-e and the actual string to be displayed is entered in SIMPL Windows. As of this publication date only completely single byte or completely multibyte strings may be entered or they will not be compiled correctly in SIMPL Windows. In other words, you cannot enter Chinese characters interspersed with numbers. You can enter Chinese characters or numbers in separate strings or you can pad each number with “\x00” to make it multibyte and then combine it with Chinese characters in the same string.

Of course you can always use the workaround of showing a graphic that displays the string but it is not dynamic. To compile and use multibyte characters it is essential that the operating system understand the language. Windows XP, Vista and 7 are available in many international languages and add-on software is available for other versions of Windows.

Embedded Applications

The following third-party or in-house applications are embedded in a VT Pro-e TPMC-3X project. (Refer to illustration below.)

- MJPEG Viewer

NOTE: MJPEG Viewer can be used with Crestron’s CEN-NVS100 Network Video Streamer (sold separately).

The embedded applications have the following features:

- All embedded applications listed in the VT Pro-e ProjectView workspace are created by default for a new TPMC-3X project.
- All applications are created at project-level – one instance per project.
- The static position and size of each application can be viewed from any page.
- Four analog joins can be assigned to each application to dynamically change position and size.
- One digital feedback join or one analog join can be assigned to dynamically show/hide an application.

Embedded Applications in ProjectView



The “Embedded Application Property” window permits a choice of positions on the screen, assignment of an analog touch join type and number, and a show/hide join number.

Edit the *Default Position and Size* in the “Embedded Application Property” window to point to your new location.

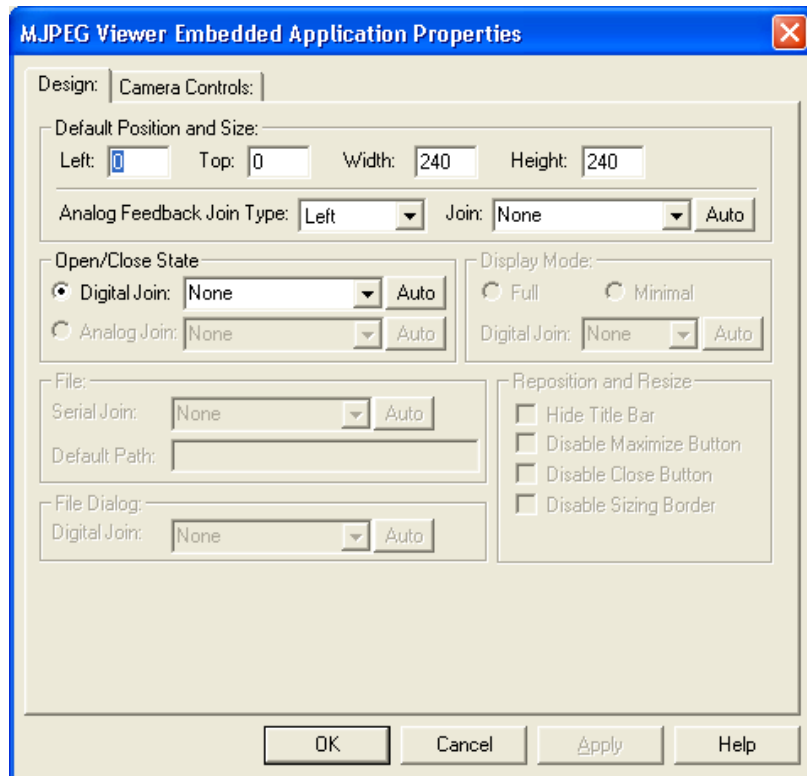
“Embedded Application Property” Window

Example Program

An example program for the TPMC-3X is available from the Crestron website (www.crestron.com/exampleprograms).

Uploading and Upgrading

The installer should use the latest programming software and ensure that each device contains the latest firmware to take advantage of the most recently released features. However, before attempting to upload or upgrade it is necessary to establish communication. Once communication has been established, files (for example, programs, projects or firmware) can be transferred to the control system (and/or device). Finally, program checks can be performed (such as changing the device ID or creating an IP table) to ensure proper functioning.

NOTE: Upgrades should be performed only by the installer.

Establishing Communication

NOTE: For PCs running Windows 2000 or XP, ActiveSync 4.5 or later is required for Toolbox to communicate with the TPMC-3X via USB to upload firmware and display lists. Download and install ActiveSync from the Microsoft website (www.microsoft.com/windowsmobile/en-us/help/synchronize/device-synch.aspx).

PCs running Windows Vista or 7™ require Windows Mobile Device Center™ for communication with Toolbox. Download and install Windows Mobile Device Center (WMDC) from the Microsoft website (www.microsoft.com/windowsmobile/devicecenter.aspx).

Use Crestron Toolbox for communicating with the TPMC-3X; refer to the Crestron Toolbox help file for details. There are two methods of communication.

Wi-Fi

NOTE: Required for operation with a Crestron control system.

Wi-Fi Communication



The TPMC-3X connects to PC via Wi-Fi:

1. Establish wireless communication between TPMC-3X and PC via the CEN-WAP-ABG-1G or CEN-WAP-ABG-CM.
2. The TPMC-3X has DHCP enabled by default. If you wish to use a static IP address, disable DHCP (refer to "IP Config" on page 19) and enter the IP address, IP mask and default router of the TPMC-3X via Crestron Toolbox (**Functions | Ethernet Addressing**).
3. Confirm Ethernet connection between TPMC-3X and PC by using the pencil tool in Crestron Toolbox (**Alt + D**), clicking *TCP*, entering the IP address (as shown on the TPMC-3X's main *Wi-Fi Setup* screen), then clicking **OK**.
4. Use the Address Book in Crestron Toolbox to create an entry for the TPMC-3X with the TPMC-3X's TCP/IP communication parameters.

5. Display the “System Info” window (click the  icon) and select the TPMC-3X entry.

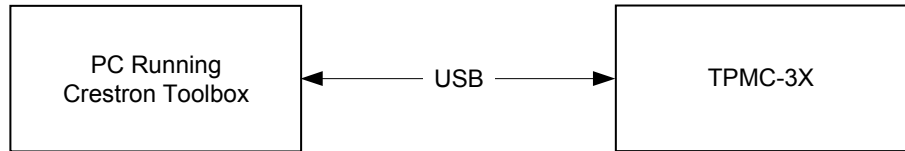
USB**USB Communication**

The **USB** port on the TPMC-3X connects to the USB port on the PC:

1. Use the included USB cable to connect the TPMC-3X to a PC running the Crestron Toolbox.
2. Open the “System Info” window; click the “**Enter an address ...**” icon (pencil) to display the “Edit Address” window.
3. Select USB as the connection type, and select “TPMC-3X” from the *Device Type* drop down list (click **OK** when the “Warning” notice appears).

Programs, Projects and Firmware

Program, project or firmware files may be distributed from programmers to installers or from Crestron to dealers. Firmware upgrades are available from the Crestron website as new features are developed after product releases. One has the option to upload programs and projects via the programming software or to upload and upgrade via the Crestron Toolbox. For details on uploading and upgrading, refer to the SIMPL Windows help file, VT Pro-e help file or the Crestron Toolbox help file.

SIMPL Windows

If a SIMPL Windows program is provided, it can be uploaded to the control system using SIMPL Windows or Crestron Toolbox.

VisionTools Pro-e

Upload the VT Pro-e file to the touchpanel using VT Pro-e or Crestron Toolbox.

Firmware

Check the Crestron website to find the latest firmware. (New users may be required to register to obtain access to certain areas of the site, including the FTP site.)

Upgrade TPMC-3X firmware via Crestron Toolbox.

1. Establish communication with the TPMC-3X and display the “System Info” window.
2. Select **Functions | Firmware...** to upgrade the TPMC-3X firmware.

Program Checks

For Ethernet connections, using Crestron Toolbox, display the “System Info window (click the  icon) and select the **Functions** menu to display actions that can be performed on the TPMC-3X.

Be sure to use Crestron Toolbox to create the TPMC-3X IP table.

1. Select **Functions | IP Table Setup**.
2. Add, modify or delete entries in the IP table. The TPMC-3X can have only one IP table entry.
3. A defined IP table can be saved to a file or sent to the device.

Edit the control system's IP table to include an entry for the TPMC-3X. The entry should list the TPMC-3X's IP ID (specified on the TPMC-3X's IP table) and the internal gateway IP address 127.0.0.1.

To prevent interference with other 802.11 devices that may be operating nearby, channels should be adequately spaced when configuring your wireless network; channels 1, 6 and 11 are the only non-overlapping channels. Refer to the information supplied with the WAP for instructions concerning channel selection.

Problem Solving

Troubleshooting

The following table provides corrective action for possible trouble situations. If further assistance is required, please contact a Crestron customer service representative.

TPMC-3X Troubleshooting

TROUBLE	POSSIBLE CAUSE(S)	CORRECTIVE ACTION
Touchpanel does not turn on.	Battery was not charged or is discharged.	Place the TPMC-3X on the docking station/charger and charge the battery using the provided power supply.
	Battery connector is not fully seated.	Check to see that battery is properly connected.
Cannot upload VT Pro-e project or firmware from Toolbox via Wi-Fi.	TPMC-3X is off or in standby mode or has no power.	Verify the TPMC-3X has power and is on or in standby mode. Standby settings may need to be lengthened.
	No WAPs defined/selected on the TPMC-3X.	Refer to "WiFi Setup" which starts on page 16 to define/select WAPs.
	No IP address configured/obtained on the TPMC-3X.	Refer to "IP Config" on page 19 to define IP addresses. If the TPMC-3X is set up to use DHCP, you can use the "IP Config" window's <i>IP Address</i> tab to verify the IP address provided. If the number is invalid for your subnet or no number is present, verify the DHCP server is working properly.
	TPMC-3X is out of range or has poor access to the WAPs.	The TPMC-3X is out of range of the WAP or is experiencing interference. For detailed information, refer to the latest version of the Best Practices for Installation and Setup of Crestron RF Products Reference Guide (Doc. 6689).
TPMC-3X does not show feedback and/or does not control any devices.	No WAPs defined/selected on the TPMC-3X.	Refer to "WiFi Setup" which starts on page 16 to define/select WAPs.

(Continued on following page)

TPMC-3X Troubleshooting (Continued)

TROUBLE	POSSIBLE CAUSE(S)	CORRECTIVE ACTION
TPMC-3X does not show feedback and/or does not control any devices (Continued).	No IP address configured/obtained on the TPMC-3X.	Refer to “IP Config” on page 19 to define IP addresses. If the TPMC-3X is set up to use DHCP, you can use the “IP Config” window’s IP Address tab to verify the IP address provided. If the number is invalid for your subnet or no number is present, verify the DHCP server is working properly.
	Invalid control system IP address / IP ID set up on TPMC-3X.	The IP address (or host name) for the control system is invalid or the IP ID does not match the one defined in the SIMPL program. Refer to “IP Config” on page 19 to define IP addresses.
	TPMC-3X is out of range or has poor access to the WAPs.	The TPMC-3X is out of range of the WAP or is experiencing interference. For detailed information, refer to the latest version of the Best Practices for Installation and Setup of Crestron RF Products Reference Guide (Doc. 6689).
TPMC-3X shows unexpected or intermittent feedback and/or has intermittent device control.	TPMC-3X is out of range or has poor access to the WAPs.	The TPMC-3X is out of range of the WAP or is experiencing interference. For detailed information, refer to the latest version of the Best Practices for Installation and Setup of Crestron RF Products Reference Guide (Doc. 6689).
TPMC-3X boots up in setup screens every time.	Invalid VT Pro-e project or no VT Pro-e project is loaded.	Load/reload VT Pro-e project using the Toolbox.

Reference Documents

The latest version of all documents mentioned within the guide can be obtained from the Crestron website (www.crestron.com/manuals). This link will provide a list of product manuals arranged in alphabetical order by model number.

List of Related Reference Documents

DOCUMENT TITLE
Best Practices for Installation and Setup of Crestron RF Products Reference Guide
Crestron e-Control Reference Guide

Further Inquiries

If you cannot locate specific information or have questions after reviewing this guide, please take advantage of Crestron's award winning customer service team by calling Crestron at 1-888-CRESTRON [1-888-273-7876].

You can also log onto the online help section of the Crestron website (www.crestron.com/onlinehelp) to ask questions about Crestron products. First-time users will need to establish a user account to fully benefit from all available features.

Future Updates

As Crestron improves functions, adds new features and extends the capabilities of the TPMC-3X, additional information may be made available as manual updates. These updates are solely electronic and serve as intermediary supplements prior to the release of a complete technical documentation revision.

Check the Crestron website periodically for manual update availability and its relevance. Updates are identified as an “Addendum” in the Download column.

Appendix: TBD

If applicable, appendices should appear in callout order A through X as the reader progresses from cover to cover. As new appendices are included, provide a description of the titled appendix. Each appendix requires a callout within the guide.

Software License Agreement

This License Agreement (“Agreement”) is a legal contract between you (either an individual or a single business entity) and Crestron Electronics, Inc. (“Crestron”) for software referenced in this guide, which includes computer software and as applicable, associated media, printed materials and “online” or electronic documentation (the “Software”).

BY INSTALLING, COPYING OR OTHERWISE USING THE SOFTWARE, YOU REPRESENT THAT YOU ARE AN AUTHORIZED DEALER OF CRESTRON PRODUCTS OR A CRESTRON AUTHORIZED INDEPENDENT PROGRAMMER AND YOU AGREE TO BE BOUND BY THE TERMS OF THIS AGREEMENT. IF YOU DO NOT AGREE TO THE TERMS OF THIS AGREEMENT, DO NOT INSTALL OR USE THE SOFTWARE.

IF YOU HAVE PAID A FEE FOR THIS LICENSE AND DO NOT ACCEPT THE TERMS OF THIS AGREEMENT, CRESTRON WILL REFUND THE FEE TO YOU PROVIDED YOU (1) CLICK THE DO NOT ACCEPT BUTTON, (2) DO NOT INSTALL THE SOFTWARE AND (3) RETURN ALL SOFTWARE, MEDIA AND OTHER DOCUMENTATION AND MATERIALS PROVIDED WITH THE SOFTWARE TO CRESTRON AT: CRESTRON ELECTRONICS, INC., 15 VOLVO DRIVE, ROCKLEIGH, NEW JERSEY 07647, WITHIN 30 DAYS OF PAYMENT.

LICENSE TERMS

Crestron hereby grants You and You accept a nonexclusive, nontransferable license to use the Software (a) in machine readable object code together with the related explanatory written materials provided by Crestron (b) on a central processing unit (“CPU”) owned or leased or otherwise controlled exclusively by You and (c) only as authorized in this Agreement and the related explanatory files and written materials provided by Crestron.

If this software requires payment for a license, you may make one backup copy of the Software, provided Your backup copy is not installed or used on any CPU. You may not transfer the rights of this Agreement to a backup copy unless the installed copy of the Software is destroyed or otherwise inoperable and You transfer all rights in the Software.

You may not transfer the license granted pursuant to this Agreement or assign this Agreement without the express written consent of Crestron.

If this software requires payment for a license, the total number of CPUs on which all versions of the Software are installed may not exceed one per license fee (1) and no concurrent, server or network use of the Software (including any permitted back-up copies) is permitted, including but not limited to using the Software (a) either directly or through commands, data or instructions from or to another computer (b) for local, campus or wide area network, internet or web hosting services or (c) pursuant to any rental, sharing or “service bureau” arrangement.

The Software is designed as a software development and customization tool. As such Crestron cannot and does not guarantee any results of use of the Software or that the Software will operate error free and You acknowledge that any development that You perform using the Software or Host Application is done entirely at Your own risk.

The Software is licensed and not sold. Crestron retains ownership of the Software and all copies of the Software and reserves all rights not expressly granted in writing.

OTHER LIMITATIONS

You must be an Authorized Dealer of Crestron products or a Crestron Authorized Independent Programmer to install or use the Software. If Your status as a Crestron Authorized Dealer or Crestron Authorized Independent Programmer is terminated, Your license is also terminated.

You may not rent, lease, lend, sublicense, distribute or otherwise transfer or assign any interest in or to the Software.

You may not reverse engineer, decompile or disassemble the Software.

You agree that the Software will not be shipped, transferred or exported into any country or used in any manner prohibited by the United States Export Administration Act or any other export laws, restrictions or regulations (“Export Laws”). By downloading or installing the Software You (a) are certifying that You are not a national of Cuba, Iran, Iraq, Libya, North Korea, Sudan, Syria or any country to which the United States embargoes goods (b) are certifying that You are not otherwise prohibited from receiving the Software and (c) You agree to comply with the Export Laws.

If any part of this Agreement is found void and unenforceable, it will not affect the validity of the balance of the Agreement, which shall remain valid and enforceable according to its terms. This Agreement may only be modified by a writing signed by an authorized officer of Crestron. Updates may be licensed to You by Crestron with additional or different terms. This is the entire agreement between Crestron and You relating to the Software and it supersedes any prior representations, discussions, undertakings, communications or advertising relating to the Software. The failure of either party to enforce any right or take any action in the event of a breach hereunder shall constitute a waiver unless expressly acknowledged and set forth in writing by the party alleged to have provided such waiver.

If You are a business or organization, You agree that upon request from Crestron or its authorized agent, You will within thirty (30) days fully document and certify that use of any and all Software at the time of the request is in conformity with Your valid licenses from Crestron or its authorized agent.

Without prejudice to any other rights, Crestron may terminate this Agreement immediately upon notice if you fail to comply with the terms and conditions of this Agreement. In such event, you must destroy all copies of the Software and all of its component parts.

PROPRIETARY RIGHTS

Copyright. All title and copyrights in and to the Software (including, without limitation, any images, photographs, animations, video, audio, music, text and “applets” incorporated into the Software), the accompanying media and printed materials and any copies of the Software are owned by Crestron or its suppliers. The Software is protected by copyright laws and international treaty provisions. Therefore, you must treat the Software like any other copyrighted material, subject to the provisions of this Agreement.

Submissions. Should you decide to transmit to Crestron’s website by any means or by any media any materials or other information (including, without limitation, ideas, concepts or techniques for new or improved services and products), whether as information, feedback, data, questions, comments, suggestions or the like, you agree such submissions are unrestricted and shall be deemed non-confidential and you automatically grant Crestron and its assigns a non-exclusive, royalty-free, worldwide, perpetual, irrevocable license, with the right to sublicense, to use, copy, transmit, distribute, create derivative works of, display and perform the same.

Trademarks. CRESTRON and the Swirl Logo are registered trademarks of Crestron Electronics, Inc. You shall not remove or conceal any trademark or proprietary notice of Crestron from the Software including any back-up copy.

GOVERNING LAW

This Agreement shall be governed by the laws of the State of New Jersey, without regard to conflicts of laws principles. Any disputes between the parties to the Agreement shall be brought in the state courts in Bergen County, New Jersey or the federal courts located in the District of New Jersey. The United Nations Convention on Contracts for the International Sale of Goods shall not apply to this Agreement.

CRESTRON LIMITED WARRANTY

CRESTRON warrants that: (a) the Software will perform substantially in accordance with the published specifications for a period of ninety (90) days from the date of receipt and (b) that any hardware accompanying the Software will be subject to its own limited warranty as stated in its accompanying written material. Crestron shall, at its option, repair or replace or refund the license fee for any Software found defective by Crestron if notified by you within the warranty period. The foregoing remedy shall be your exclusive remedy for any claim or loss arising from the Software.

CRESTRON shall not be liable to honor warranty terms if the product has been used in any application other than that for which it was intended or if it as been subjected to misuse, accidental damage, modification or improper installation procedures. Furthermore, this warranty does not cover any product that has had the serial number or license code altered, defaced, improperly obtained or removed.

Notwithstanding any agreement to maintain or correct errors or defects, Crestron shall have no obligation to service or correct any error or defect that is not reproducible by Crestron or is deemed in Crestron’s reasonable discretion to have resulted from (1) accident; unusual stress; neglect; misuse; failure of electric power, operation of the Software with other media not meeting or not maintained in accordance with the manufacturer’s specifications or causes other than ordinary use; (2) improper installation by anyone other than Crestron or its authorized agents of the Software that deviates from any operating procedures established by Crestron in the material and files provided to You by Crestron or its authorized agent; (3) use of the Software on unauthorized hardware or (4) modification of, alteration of or additions to the Software undertaken by persons other than Crestron or Crestron’s authorized agents.

ANY LIABILITY OF CRESTRON FOR A DEFECTIVE COPY OF THE SOFTWARE WILL BE LIMITED EXCLUSIVELY TO REPAIR OR REPLACEMENT OF YOUR COPY OF THE SOFTWARE WITH ANOTHER COPY OR REFUND OF THE INITIAL LICENSE FEE CRESTRON RECEIVED FROM YOU FOR THE DEFECTIVE COPY OF THE PRODUCT. THIS WARRANTY SHALL BE THE SOLE AND EXCLUSIVE REMEDY TO YOU. IN NO EVENT SHALL CRESTRON BE LIABLE FOR INCIDENTAL, CONSEQUENTIAL, SPECIAL OR PUNITIVE DAMAGES OF ANY KIND (PROPERTY OR ECONOMIC DAMAGES INCLUSIVE), EVEN IF A CRESTRON REPRESENTATIVE HAS BEEN ADVISED OF THE POSSIBILITY OF SUCH DAMAGES OR OF ANY CLAIM BY ANY THIRD PARTY. CRESTRON MAKES NO WARRANTIES, EXPRESS OR IMPLIED, AS TO TITLE OR INFRINGEMENT OF THIRD-PARTY RIGHTS, MERCHANTABILITY OR FITNESS FOR ANY PARTICULAR PURPOSE, OR ANY OTHER WARRANTIES, NOR AUTHORIZES ANY OTHER PARTY TO OFFER ANY WARRANTIES, INCLUDING WARRANTIES OF MERCHANTABILITY FOR THIS PRODUCT. THIS WARRANTY STATEMENT SUPERSEDES ALL PREVIOUS WARRANTIES.

Return and Warranty Policies

Merchandise Returns / Repair Service

1. No merchandise may be returned for credit, exchange or service without prior authorization from CRESTRON. To obtain warranty service for CRESTRON products, contact an authorized CRESTRON dealer. Only authorized CRESTRON dealers may contact the factory and request an RMA (Return Merchandise Authorization) number. Enclose a note specifying the nature of the problem, name and phone number of contact person, RMA number and return address.
2. Products may be returned for credit, exchange or service with a CRESTRON Return Merchandise Authorization (RMA) number. Authorized returns must be shipped freight prepaid to CRESTRON, 6 Volvo Drive, Rockleigh, N.J. or its authorized subsidiaries, with RMA number clearly marked on the outside of all cartons. Shipments arriving freight collect or without an RMA number shall be subject to refusal. CRESTRON reserves the right in its sole and absolute discretion to charge a 15% restocking fee plus shipping costs on any products returned with an RMA.
3. Return freight charges following repair of items under warranty shall be paid by CRESTRON, shipping by standard ground carrier. In the event repairs are found to be non-warranty, return freight costs shall be paid by the purchaser.

CRESTRON Limited Warranty

CRESTRON ELECTRONICS, Inc. warrants its products to be free from manufacturing defects in materials and workmanship under normal use for a period of three (3) years from the date of purchase from CRESTRON, with the following exceptions: disk drives and any other moving or rotating mechanical parts, pan/tilt heads and power supplies are covered for a period of one (1) year; touchscreen display and overlay components are covered for 90 days; batteries and incandescent lamps are not covered.

This warranty extends to products purchased directly from CRESTRON or an authorized CRESTRON dealer. Purchasers should inquire of the dealer regarding the nature and extent of the dealer's warranty, if any.

CRESTRON shall not be liable to honor the terms of this warranty if the product has been used in any application other than that for which it was intended or if it has been subjected to misuse, accidental damage, modification or improper installation procedures. Furthermore, this warranty does not cover any product that has had the serial number altered, defaced or removed.

This warranty shall be the sole and exclusive remedy to the original purchaser. In no event shall CRESTRON be liable for incidental or consequential damages of any kind (property or economic damages inclusive) arising from the sale or use of this equipment. CRESTRON is not liable for any claim made by a third party or made by the purchaser for a third party.

CRESTRON shall, at its option, repair or replace any product found defective, without charge for parts or labor. Repaired or replaced equipment and parts supplied under this warranty shall be covered only by the unexpired portion of the warranty.

Except as expressly set forth in this warranty, CRESTRON makes no other warranties, expressed or implied, nor authorizes any other party to offer any warranty, including any implied warranties of merchantability or fitness for a particular purpose. Any implied warranties that may be imposed by law are limited to the terms of this limited warranty. This warranty statement supersedes all previous warranties.

Trademark Information

All brand names, product names and trademarks are the sole property of their respective owners. Windows is a registered trademark of Microsoft Corporation. Windows95/98/Me/XP/Vista/7 and WindowsNT/2000 are trademarks of Microsoft Corporation.

This page is intentionally left blank.

This page is intentionally left blank.

