TECHNICAL MANUAL

CTX-5000 SYSTEM MANUAL

CTX-5000 (5 KW)

SOLID STATE TRANSMITTER



Cubic Communications, Inc.
9535 Waples Street
San Diego, California 92121-2953

Telephone: (619) 643-5800 Telefax: (619) 643-5803

Manual Part No. 2245-1020-1

ISSUE 2.0

12 February 1999

RECORD OF CHANGES

CHANGE	DATE	TITLE OF BRIEF DESCRIPTIONS	ENTERED BY
Issue 2.0	2/12/99	Update foldouts and figures to include AC line filter, per DCR #727825	CCI Eng

FOREWORD

SCOPE

This manual contains information for the installer and operator to obtain best performance from the CTX-5000 Solid State Transmitter. The information includes: a general description, preparation for use and installation instructions, operating instructions, general theory of operation, maintenance instructions, and preparation for reshipment.

Module level maintenance is not included in this manual. Refer to the individual equipment manuals for specific maintenance information. Component level maintenance should be performed in the designated maintenance depot or the factory.

WARNING

Do not apply power to the equipment until the installation procedures in Chapter 2 have been successfully completed.

PROPRIETARY DATA

The information in this manual is the property of Cubic Communications Incorporated. Disclosure to a third party, either wholly or in part, without written consent from Cubic Communications Incorporated is prohibited.

CORRECTION NOTICE

The information in this manual is believed correct at publication date. If a difference is noted between the information in this manual and the equipment, contact the factory for clarification. Current and future editions will be corrected as necessary.

FCC COMPLIANCE

This device complies with FCC Part 15B and 87, EMC Testing..

RIGHTS RESERVED

Cubic Communications Incorporated reserves the right to change the specifications, design, and fabrication methods of equipment at any time without notice.

TABLE OF CONTENTS

<u>Chapter</u>		<u>Page</u>
1	GENERAL DESCRIPTION	1-1
1-1	INTRODUCTION	1-1
1-2	SYSTEM DESCRIPTION	1-1
	1-2.1 <i>Power Supply</i>	1-1
	1-2.2 <i>T-4180 Exciter</i>	1-1
	1-2.3 <i>Splitter</i>	1-2
	1-2.4 <i>Controller</i>	1-2
	1-2.4.1 <i>Hardware Description</i>	1-2
	1-2.4.2 <i>Software Description</i>	1-3
	1-2.5 <i>PA-5050A</i>	1-3
	1-2.6 <i>Combiner/Directional Coupler</i>	1-4
	1-2.7 <i>Circuit Breaker Panels</i>	1-4
1-3	EQUIPMENT FURNISHED	1-4
1-4	STORAGE DATA	1-4
1-5	TOOLS AND TEST EQUIPMENT	1-4
1-6	SAFETY PRECAUTIONS	1-4
2	PREPARATION FOR USE AND INSTALLATION INSTRUCTIONS	2-1
2-1	INTRODUCTION	2-1
2-2	INSTALLATION	2-1
2-3	CONNECTIONS	2-2
2-4	INITIAL POWER SUPPLY SETTINGS	2-5
3	OPERATING INSTRUCTIONS	3-1
3-1	INTRODUCTION	3-1
3-2	OPERATION	3-1
	3-2.1 <i>CTX System Operation</i>	3-1
	3-2.2 <i>Software Upload Procedures</i>	3-1
	3-2.2.1 <i>T-4180 Upload Procedure</i>	3-1
	3-2.2.2 <i>Controller Upload Procedure</i>	3-1
	3-2.2.3 <i>PA-5050A Upload Procedure</i>	3-2
3-3	POWER ON APPLICATION & STANDARD OPERATION PROCEDURES	3-3
	3-3.1 <i>Power On Application</i>	3-3
	3-3.2 <i>Standard Operation</i>	3-3
3-4	EMERGENCY OPERATION	3-4
	3-4.1 <i>PA-5050A Failure</i>	3-4
	3-4.2 <i>PA-5050A Module Failure</i>	3-5
3-5	CTX T-4180 EXCITER DIFFERENCES	3-5
	3-5.1 <i>Secondary Softkey Differences</i>	3-5
	3-5.1.1 <i>STORE</i>	3-6
	3-5.1.2 <i>RECALL</i>	3-6
	3-5.1.3 <i>PAPOW</i>	3-6
	3-5.1.4 <i>PASTAT</i>	3-7
	3-5.1.5 <i>PAGAIN</i>	3-7
	3-5.2 <i>Remote Operation</i>	3-8
4	PARTS LIST	4-1
4-1	INTRODUCTION	4-1
4-2	REPLACEABLE PARTS LIST	4-1

LIST OF ILLUSTRATIONS

<u>Figure</u>		<u>Page</u>
1-1	CTX-5000 Front View	1-5
2-1	CTX-5000 Rear View	2-4
3-1	CTX T-4180 Secondary Soft Key Flow Diagram	3-5
FO-1	CTX 5000 Block Diagram	FP-1
FO-2	CTX 5000 Interconnect Diagram	FP-2
FO-3	CTX 5000 Replaceable Parts Locator Diagram	FP-4

LIST OF TABLES

<u>Table</u>		<u>Page</u>
1-1	CTX 5000 Specifications	1-6
1-2	Items Furnished	1-7
2-1	Rear Panel Connections	2-2
3-1	Controller Upload Cable	3-2
3-2	PA-5050A Upload Cable	3-3
3-3	PA-5050A Failure Output Power	3-4
3-4	CTX T-4180 Exciter Command and Status Messages	3-8
4-1	CTX-5000 Replaceable Parts List	4-1

CHAPTER 1

GENERAL DESCRIPTION

1-1 INTRODUCTION. The CTX-5000 (5 kW) figure 1-1 is a high powered solid-state HF Transmitter designed to provide 100% continuous-duty operation. This transmitter is based on field-proven 1 kW Amplifiers combined in a conservative, no-compromise, high-powered configuration.

Complete coverage of the entire HF frequency spectrum from 2 to 30 MHz is provided in synthesized 1 Hz steps. Low level signals are generated by the T-4180 Exciter. The Exciter incorporates Digital Signal Processing to derive all standard operating modes (LSB, LSBfc, LSBpc, USB, USBfc, USBpc, ISB, AM, FM, FMfax, CW, & FSK.) This also assures the linearity and spectral purity needed for advanced modes such as Link 11, ANDVT, ALE, frequency hopping, high speed data and future waveforms. For more information to the T-4180, refer to the T-4150/80 Technical Manual.

The CTX-5000 Transmitter can operate locally or remotely. Complete status and control is available from the front panel and via remote control over RS-232 or RS-422 interfaces. This includes full remote monitoring and diagnosis of critical functions for each system component including the amplifier modules. Onboard monitoring and control system provides early detection of faults and adjustments of imbalances to prevent system failure. Individual defective PA modules can be either automatically or manually taken "offline" with only an incremental reduction in total output power. Harmonic and spurious radiation have been minimized through the use of high performance filters in each 1 kW amplifier module. In addition, the T-4180 Exciter includes a built-in postselector to reduce wideband noise generation.

The heart of the CTX-5000 Transmitter is the T-4180 HF Exciter which incorporates Digital Signal Processing (DSP). The DSP technology enables the technician to easily upload new software. This can be done by disk or remotely in the field via E-Mail.

1-2 SYSTEM DESCRIPTION. This section describes the major components that make up the CTX-5000 System.

1-2.1 Power Supply. There are 2 power supplies used in the CTX-5000. Each power supply provides power to three PA-5050 power amplifiers. Additionally, the outputs of all power supplies are diode summed to provide power to the controller and the combiner fans. In the event of a power supply failure, the system is still operational at a reduced output power level (800 watts maximum).

Each power supply provides 28 volts at up to 330 amps. These are high efficiency switch-mode power supplies which run off 208 V, 3-phase AC input power (other voltages available). A 3-phase, 80 amp/phase EMI filter conditions and filters the AC input to the power supplies. The power supplies are fully protected against excessive load current (including short circuits) and over-temperature conditions. They also incorporate an over-voltage shutdown function which protects the power amplifiers in the event of a failure in the power supply which causes the output voltage to rise. Meters are provided on the front panel of each power supply to monitor the output voltage and current. Cooling is provided by fans built into the power supplies.

1-2.2 T-4180 Exciter. The T-4180 is a multi-mode digital signal processing (DSP) exciter with a frequency range from 2 to 30 MHz. The RF output from J3 of the T-4180 is routed to the Splitter.

The exciter is controlled by a 19-button keypad and main adjustment knob used to select the exciter parameters. Five "soft keys" work in conjunction with the vacuum fluorescent digital display immediately above the soft keys. In addition to soft key selections, the vacuum fluorescent digital display provides a variety of data including channel, modulation mode, frequency, bandwidth, gain, local/remote control, an RF level meter, and an AF level meter. Additional information is displayed depending on soft key selections.

By proper selection of parameters, the exciters can generate a wide variety of signals. These include: on/off keyed (CW), amplitude modulation (AM), upper sideband (USB), upper sideband - full carrier (USBfc), upper sideband - partial carrier (USBpc), lower sideband (LSB), lower sideband - full carrier (LSBfc), lower sideband - partial carrier

(LSBpc), independent sideband (ISB) (suppressed carrier and independent), frequency shift keyed (FSK), frequency modulation (FM), and frequency modulation facsimile (FMfax).

The selected audio input is provided on a 600 ohm balanced line. Normal and alternate (LSB audio when ISB is selected) audio are simultaneously input on separate 600 ohm balanced lines.

A MIC/KEY jack on the front panel provides for connection of an external microphone or CW key. The audio level is automatic. The audio is automatically applied to the correct modulator depending on the modulation mode. However, when ISB modulation is selected, microphone audio is directed to the normal audio channel only.

The exciter may be remotely controlled by any suitable bus controller using either an RS-232 or RS-422 serial interface bus. As an option, the exciter can be placed in a location different than that of the CTX chassis. If this option is desired, additional cable lengths and a empty half rack chassis, to replace the current location of the exciter, will need to be manufactured, see table 1-2.

Refer to the T-4150/80 Technical Manual for more details.

1-2.3 Splitter. The RF signal from the exciter is applied to the Splitter module. The Splitter module provides six equal RF outputs to each of the PA-5050A power amplifiers.

1-2.4 Controller. The controller consists of an embedded 80386 processor, a communications interface logic and signal processing board, DC power supply, indicators and various external connectors. The heart of the controller is centered around the 80386 processor. It has two primary functions: Provide communications between the T-4180 exciter and the six PA-5050A amplifiers and manage control of the system as a whole.

1-2.4.1 Hardware Description The controller's main hardware is the processor and the interface board. the following paragraphs discuss these components.

Processor: The 80386 embedded processor is supported by 1 megabyte of RAM, a 12 bit, 8-channel A/D converter, two RS-422 serial ports and a 24 bit I/O data and control interface. The processor runs at 20 MHz and supports Flash Memory for storing executable code. The A/D converter is used to sample the system level forward and reflected output power and temperature sensors in the external system power combiner. The RS-422 serial ports provide the communications between the T-4180 exciter and the controller and between the controller and the six PA-5050A's. Software is loaded into flash memory via one of the serial ports when a reset of the processor is performed and a special upload cable is attached. There are two LED indicators on the processor board. One is a green power indicator and the other is a red general purpose LED. The red LED can be used under software control.

The processor requires +5 and +/- 12V for normal operation. This is externally provided through a DC-DC converter.

Interface Board: The interface board is used to condition signals going to and from the T-4180 and the six PA-5050A's. It also accepts reduced system level RF power and temperature inputs from the external power combiner. These RF input signals are converted to a voltage suitable for output to the A/D converter on the processor board through the use of a log amplifier circuit. The interface board has a DC-DC converter that converts +28V to +5 and +/- 12V required by the interface board and the processor.

RS-422 Serial inputs and outputs are routed through the interface board to the processor. The RS-422 serial data destined for the six PA-5050A's originates out of COM2 of the processor and is routed to the designated PA by control logic on the interface board. This control logic first converts the RS-422 differential levels to standard 5V logic levels, routes them through a multiplexer and then converts the 5V logic level back to RS-422 differential levels. The communication interface between the PA-5050A's and the processor operates half duplex. The processor's 24-bit I/O interface is used to control the multiplexer and signal direction logic on the interface board. The system enables two methods of communications to the PA's. Under normal operating conditions, the command communications to each PA is addressed separately. Additionally, a broadcast control line, under software control, can be used to send commands simultaneously to all PA's. However, responses can only be received separately. The transmit key coming from the T-4180 is also routed through the interface board to the processor 24-bit I/O port.

It supports a 5V pull up resistor on the input key line. The processor interprets this key line and provides separate software controlled key lines back to all the PA's through the interface board.

The RF forward and reflected power inputs coming from the system power combiner are representative of the total system power output, reduced by 60db. These are fed into a log amplifier circuit that converts the RF forward and reflected power to a DC voltage prior to being routed to the processor A/D converter. The analog temperature inputs coming from the system power combiner are for thermal protection of the combiner. These are routed to the processor A/D converter for sampling.

The interface board accepts +28V from an external power source and routes it to the DC-DC converter. The resulting output of +5V and +/- 12V is used on the interface board and routed to the processor board through an on board connector.

The interface board also provides outputs for three, front panel mounted, indicator LED lamps. The LED's indicate the status of DC power, data communications between the controller and the PA's, and a general-purpose error indicator.

There are no manual, externally controlled user interfaces. All status information, with the exception of the front panel LED's, is retrieved through the T-4180 PA status screen.

1-2.4.2 Software Description A software program specifically designed for this application controls the processor. It was written using the C programming language and compiled using Borland® C 4.52. The software tasks include, but are not limited to, serial communication and message processing, system power level management, system status information retrieval and processing, and progressive system shutdown in the event of a failure. The software functions are described in the following paragraphs.

The main function is a loop that services the foreground tasks. These include checking for incoming messages from the T-4180, controlling the transmit key line, updating the forward and reflected power readings, updating the temperature readings, interrogating each PA for status and taking corrective action for any detected errors.

The background routines primarily consist of the interrupt service routines for each communication interface going to and from the controller, PA's and the T-4180. These routines are interrupt driven and notify the foreground routine only when a serial message has been received. The serial interfaces operate at a speed of 19200 bits per second, with the line parameters set at 8 data bits, 1 Stop bit and No Parity bit.

The communications between the T-4180 and the controller works on a polled basis whereby the controller responds to commands and replies to queries only when requested by the T-4180. This places the T-4180 in charge of the RS-422 data line between the T-4180 and the controller. It is operated in the half-duplex mode.

The communications between the controller and the six PA-5050's works on a polled basis. Each PA responds to commands and replies to queries only when requested by the controller. This places the controller in charge of the RS-422 data line between the controller and the PA-5050A's. It is operated in the half-duplex mode. The controller to PA serial update rate is set near maximum for the given 19200 bits per second baud rate. This means that the controller can receive status from each PA approximately twice a second, giving a system level update of one every 500 milliseconds.

1-2.5 PA-5050A. There are six PA-5050A linear power amplifiers. Each is a solid state unit that provides 1 kilowatt, reduced to approximately 900W, power amplification of RF signals between 2 and 30 MHz. The unit contains 4 independent power amplifier (PA) modules. If one or more of the PA modules fail, the CTX system will still operate with reduced power out.

The front panel contains a PWR LED with each PA module containing an individual PWR and FLT LED, and a multifunction display. Input power to the PA-5050A is derived from a separate +28V DC power supply providing five separate +28V DC outputs. Four independent modular PA modules provide the four stages of amplification. Each PA module is identical and interchangeable. When an individual PA module's gain is less than +10 dB, the circuitry turns on the FLT LED. The individual module can then be removed and replaced.

The rear panel contains connectors for the transmitter/exciter low power RF input, high power RF output to the Combiner/Directional Coupler RF input, DC power input and serial interface.

Sixteen internal fans per PA-5050A provide cooling across the heatsinks of the unit.

Refer to the PA-5050A Technical Manual for more detailed information

1-2.6 Combiner/Directional Coupler. The six PA-5050 outputs are applied to the six inputs of the combiner. The six inputs are combined to produce the 5 kW final output. The combiner has a maximum insertion loss of 0.35 dB, therefore, the maximum required input power for 5 kW out is approximately 5.4 kW or 900 watts per input.

To protect the combiner from excessive power dissipation (due to mismatched inputs or a high VSWR load), three thermistors are located at various points within the combiner to sense the temperature. These thermistors are monitored by the controller and if an excessive temperature is detected, the input power to the combiner is reduced to protect the combiner from damage.

The output of the combiner is applied to a dual directional coupler. The coupler provides two RF outputs that are proportional to forward and reflected power. The coupling ratio is 60 dB. The forward output is used by the controller to monitor the output power during the power setting process. The reflected output is used by the controller to sense the presence of a high VSWR load so that the controller can reduce the power into the combiner and protect it from damage. The measured forward and reflected output power values are also sent by the controller to the T-4180 where they are displayed in the PASTAT screen.

1-2.7 Circuit Breaker Panels Two circuit breaker panels, each containing three sets of five circuit breakers are used to protect the internal modules and components of each PA-5050A. Circuit breakers 1-4 are 30 amp breakers that protect modules 1-4 in each PA-5050A. The 5th circuit breaker is a 10 amp Auxiliary circuit breaker used to protect the auxiliary internal components of the PA-5050A. The Control 10 amp circuit breaker, located on the far right of the circuit breaker panel protects the Combiner and the two fans located in the Combiner/Directional Coupler.

1-3 EQUIPMENT FURNISHED. Table 1-2 lists the items furnished with the system

1-4 STORAGE DATA. Refer to the T-4180/50 and PA-5050A Technical Manuals for individual equipment storage data. The CTX system should be stored indoors. the humidity should be no greater than 95% (storage & operation) with a storage temperature range of -40° to +55° C, (0° to 50° C operating.)

1-5 TOOLS AND TEST EQUIPMENT. Refer to the specific manuals for the T-4180 Exciter and PA-5050A Power Supply. There are no special tools or test equipment required.

1-6 SAFETY PRECAUTIONS. Safety precautions are presented in this manual preceded by the word WARNING or CAUTION just before the point where the hazard is likely to be encountered. Warnings and cautions are defined as follows:

WARNING

Refers to a procedure or practice that, if not correctly followed, could result in injury, death, or long term health hazard.

CAUTION

Refers to a procedure or practice that, if not correctly followed, could result in damage to, or destruction of equipment.

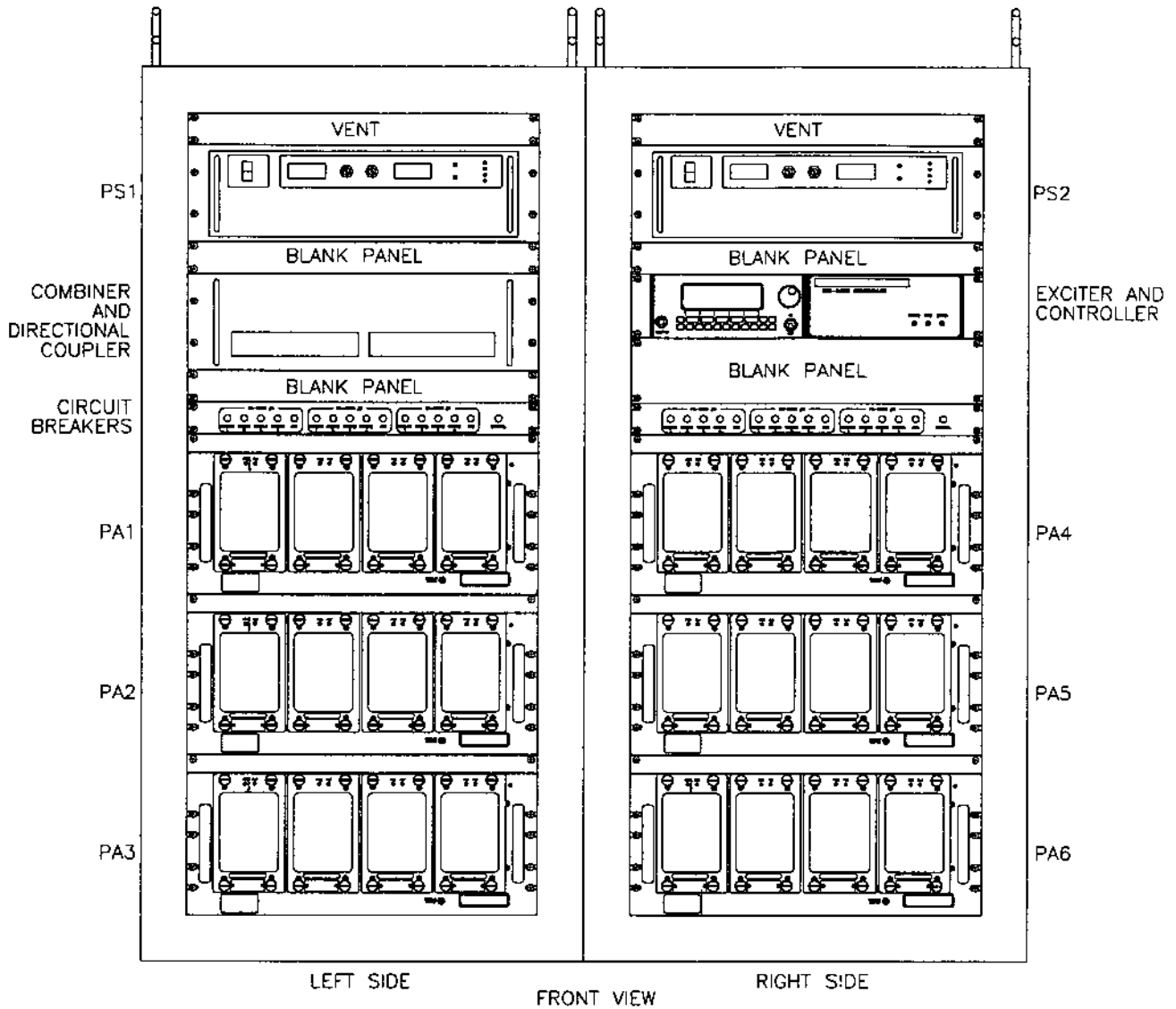

Figure 1-1 CTX 5000 Front View

Table 1-1 CTX-5000 Specifications.

Item	Specification
ELECTRICAL REQUIREMENTS	
Frequency Range	2 - 30.0 MHz
Power Output	5 kW \pm 1 dB PEP and average. Rated for 100% continuous duty. Adjustable from 0 to 60 dB in 1 dB steps..
Intermodulation Distortion	<30 dB below PEP (3 rd order)
Filter Bands (in MHz)	Band 0: 2.0-2.31 Band 4: 6.94-10.0 Band 1: 2.31-3.34 Band 5: 10.0-14.42 Band 2: 3.34-4.81 Band 6: 14.42-20.8 Band 3: 4.81-6.94 Band 7: 20.8-30.0
Output VSWR	Full power output up to 2:1. Gradual power shutdown above 500W reflected power. Protected from short and open circuits.
Output Impedance	50 ohms.
Input Voltage	190-250 VAC, three phase with a maximum of 65 amps/phase, 47-63 Hz, 24 kVA, Ratio of real power to apparent power (power factor) is 0.9
GENERAL	
Modulation Modes	CW, AM, USB, USBfc, USBpc, LSB, LSBfc, LSBpc, ISB, FSK, FM & FMfax
Remote Control	RS-232 or RS-422
Programable Channels	250
Audio Inputs	0 dBm, 600 ohms
Harmonics	-65 dBc
Spurious	-60 dBc within 20 kHz, otherwise -80 dBc or better
Frequency Stability	0.1 ppm (can be locked to external 10 MHz frequency standard)
ENVIRONMENTAL	
Ambient Temperature	0 to +50°C operating, -40 to +55°C storage
Humidity	95% (non-condensing)
Cooling	Forced air
Thermal Monitoring	Temperature sensing is provided in all PA modules, the power supplies, and the combiner to protect the system components from excessive temperature rise.
Cont.	

Table 1-1 CTX-5000 Specifications.

Item	Specification		
INTERFACE CONNECTORS	<u>On Chassis</u>	<u>Mates With</u>	
ANT	LC-type (F)	LC-type (M)	(Located on Combiner)
POWER	5/16" Threaded studs (Located on AC line filter)		
SERIAL REMOTE	25 - D Sub (F)	25 - D Sub (M)	(Located on T-4180)
Audio	15 - D Sub (F)	15 - D Sub (M)	(Located on T-4180)
PHYSICAL			
Size	CTX-5000: 52.5" high x 45.5" wide x 30.75" deep (One double wide 19" rack)		
Weight	CTX-5000: Approximately 900 lbs		

Table 1-2 Items Furnished.

Part No.	Nomenclature	Qty
2245-1101-1	Circuit Breaker Panel (Left side)	1
2245-1101-2	Circuit Breaker Panel (Right side)	1
118-097	2-way Combiner/Directional Coupler	1
118-XXX	2-way Combiner/Directional Coupler	0
2245-1101-1	Controller, 5 KW	1
2245-1101-2	Controller, 10 KW	0
2600-1000-1	Half Rack Chassis, Empty (Optional, used only if T-4180 is located in an area away from the CTX chassis.)	1
2241-1000-X	Power Amplifier; PA-5050A	6
275-014	Power Supply: 28V 330 Amp	2
118-098	6-way Splitter	1
118-XXX	12-way Splitter	0
2245-1020-1	CTX-5000 System Manual	1
2607-1000-10	T-4180 MF-HF Transmitter/Exciter, 20-100 milliwatts PEP	1
2241-1021-3	Technical Manual, Operation and Maintenance Instructions, POWER AMPLIFIER, PA-5050A (FCC Version)	1
2607-1021-1	Technical Manual, Operation and Maintenance Instructions, EXCITER, DIGITAL SIGNAL PROCESSING SINGLE MF-HF T-4150/80	1
-	Antenna system and attaching cables (Required but not supplied)	
"X" indicates model number and factory installed options. Refer to ID plate on the equipment.		

CHAPTER 2

PREPARATION FOR USE AND INSTALLATION INSTRUCTIONS

2-1 INTRODUCTION. This chapter contains inspection, installation, connections, and initial alignment procedures for the PA-5050A.

2-2 INSTALLATION. The CTX-5000 hardware is designed as a rack cabinet mounted system. It should be operated in a relatively dust free environment with an ambient temperature range between 0 and +50°C.

1. Pre-drill anchor bolt holes into the floor/deck where the CTX-5000 is to be placed.

NOTE

This is an optional procedure. Anchoring is mandatory only if the CTX cabinet is to be located in an unstable platform. There are a maximum of 16 anchor bolt holes (eight/cabinet) that can be used for anchoring the CTX cabinet to the floor/deck. Two anchor bolt holes are located in each corner of a cabinet.

2. Secure the eight eye-bolts to the top of the cabinet if not already installed.
3. Align the front four eye-bolts so that a pipe or metal bar can be slid through the eyelets. Align the four rear eye-bolts in the same manner.
4. Slide a strong pipe or metal bar through the front and rear set of eyelets.

CAUTION

Insure the pipe or metal bar is capable of handling the weight of the cabinet. The material used should be either capped on each end or be long enough so as not to allow the cabinet to slide off.

5. Using a forklift or other similar device, lift the cabinet and move in place. As an option, rollers can be placed under the cabinet for movement.

CAUTION

When lifting the cabinet, use all eight eye-bolts to distribute the load evenly throughout the cabinet. Failure to use all eight eye-bolts may stress the cabinet beyond its limitations.

6. Attach power cable (not supplied) to the AC line filter, located in the bottom of the cabinet.

WARNING

Severe injury or **DEATH** can result if bodily contact is made with an ungrounded chassis should high leakage current or a short-circuit condition occur. Insure the system is grounded.

7. Secure the CTX-5000 to the floor using anchor bolts (not supplied.)

2-3 CONNECTIONS. Refer to the Interconnect Diagram, F0-3, for cable connections. Figure 2-1 shows the CTX 5000 system rear view. Table 2-1 provides a brief description of the rear panel connections on each major piece of hardware that makes up the CTX-5000.

Table 2-1 Rear Panel Connections.

Name	Type	Mating Type	Description
T-4180			Refer to the T-4150/80 Technical Manual
Controller			
T-4180 CTRL	9-D Sub (M)	9-D Sub (F)	Control interface to T-4180, Serial Data
PA1 - PA6 CTRL	9-D Sub (M)	9-D Sub (F)	Control interface to PA-5050A, Serial Data
28V POWER	AMP 206061-1 (320-411)	AMP 206060-1 (320-413)	+28VDC & GND. 1 amp maximum.
COMBINER	9-D Sub (F)	9-D Sub (M)	Thermistor sense lines & fan power
FWD RF	BNC (F)	BNC (M)	Forward RF sense in from directional coupler
REV RF	BNC (F)	BNC (M)	Reverse RF sense in from directional coupler
Splitter			
COM	BNC (F)	BNC (M)	RF in from T-4180 exciter output
1 - 6	BNC (F)	BNC (M)	RF to PA-5050A RF inputs
PA-5050A			Refer to the PA-5050A Technical Manual
Power Supply			
-V OUT	3/8" Hole (2)	3/8" Bolt/Lug (2)	Negative output of 28V power supply
(J1)	25-D Sub (F)	25-D Sub (M)	Current monitor lines to controller
+V OUT	3/8" Hole (2)	3/8" Bolt/Lug	Positive output of 28V power supply
AC IN	1/4" Studs (4)	1/4" Lugs (4)	AC Power from AC line filter
AC Line Filter			
Line	5/16" Studs (4)	5/16" Lugs (4)	AC Power in, 190 - 250 VAC, 47 - 63 HZ, 3 Phase
Load	5/16" Studs (4)	5/16" Lugs (4)	AC Power to power supplies
Cont.			

Table 2-1 Rear Panel Connections.

Name	Type	Mating Type	Description
Combiner			
RF IN (J1 - J6)	Type N (F)	Type N (M)	RF Input, Approximately 900 Watts
RF OUT (J7)	LC (F)	LC (M)	RF Output 5000 watts, 2-30 MHz
FWD (J8)	BNC (F)	BNC (M)	RF signal at -60 dB Relative to Forward Power
REV (J9)	BNC (F)	BNC (M)	RF signal at -60 dB Relative to Reflected Power
FAN POWER & THERMISTORS (J10)	9-D Sub (M)	9-D Sub (M)	+28 VDC for combiner fans and thermistor sense lines.

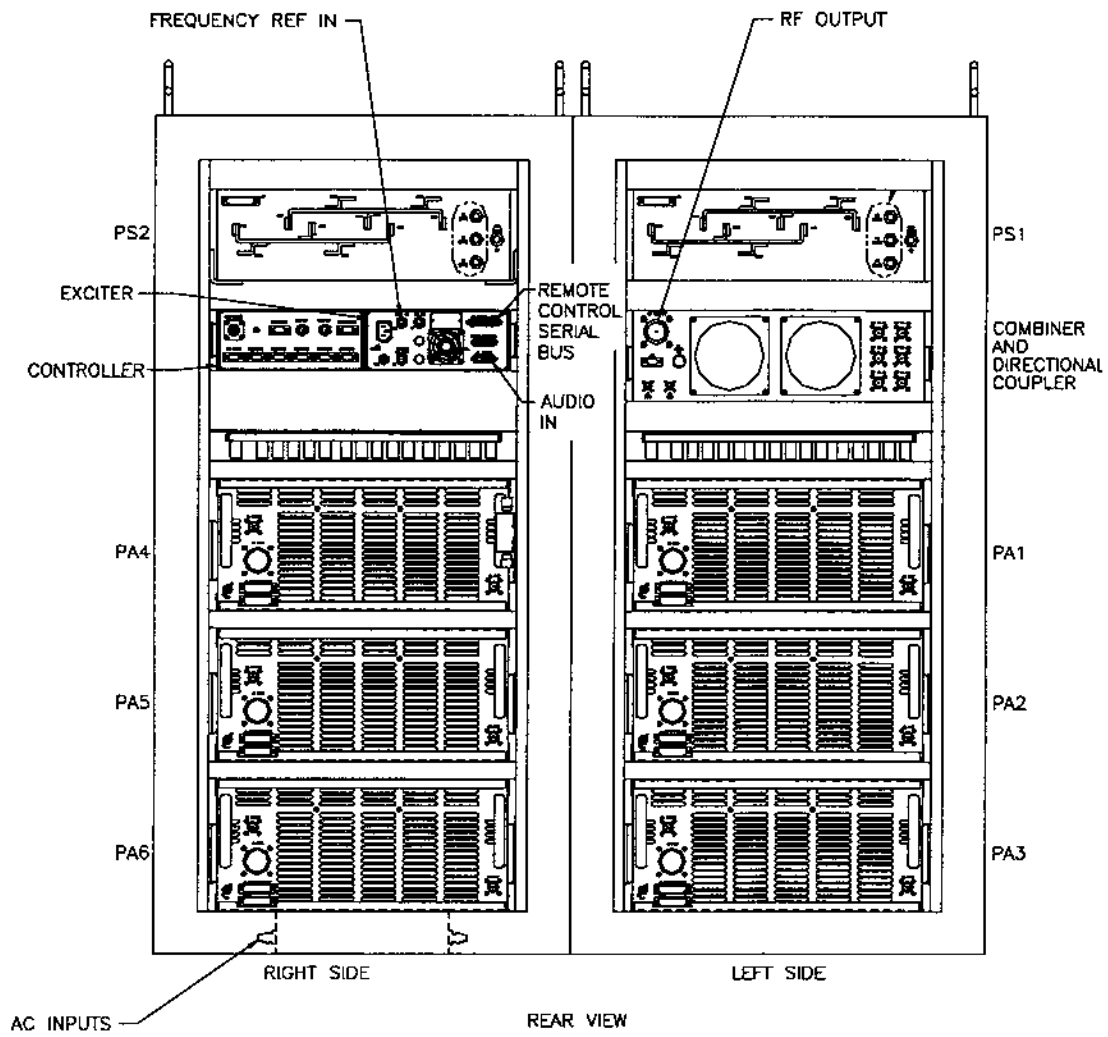

Figure 2-1 CTX-5000 Rear View

2-4 INITIAL POWER SUPPLY SETTINGS. The power supply voltage and current output settings are factory set and should not be changed. However, if the power supply setting should differ than the factory setting, use the below procedures to reset the power supply to the initial factory setting.

1. Set Voltage to 28 Volts
 - Loosen nut on the Output Voltage Control
 - Adjust the potentiometer CW or CCW until 28 Volt readout is obtained on the meter
 - Tighten nut

2. Set Current to 330 amps
 - Loosen nut on the Output Current Control
 - Adjust the potentiometer fully CW to set the current limit to maximum
 - Tighten nut

3. Set the Over Voltage Protection potentiometer to maximum (CW)

CHAPTER 3 OPERATING INSTRUCTIONS

3-1 INTRODUCTION. This chapter contains operating instructions for the CTX-5000 System.

3-2 OPERATION.

3-2.1 CTX System Operation. Operation is performed using the front panel controls and indicators on the T-4180 and the PA-5050A. Refer to the T-4150/80 and PA-5050A Technical Manuals for information on the front panel controls and indicators and their functions. Refer to section 3-3, of this manual for Power Application and Standard Operation Procedures. Refer to section 3-4, of this manual, for a description of the CTX T-4180 differences. The CTX PA-5050A operates as described in the PA-5050A manual.

3-2.2 Software Upload Procedures. There are three pieces of equipment that can be updated with new software. These are the T-4180, the Controller, and the PA-5050A's. Software updates are only necessary if problems are occurring or if changes are being made to your system. CCI will provide the necessary software upon

3-2.2.1 T-4180 Upload Procedure. Refer to the T-4150/80 Technical Manual.

3-2.2.2 Controller Upload Procedure. Perform the following procedures:

1. Build a Controller Upload Cable in accordance with the description provided in table 3-1.
2. Power off the CTX system.
3. Disconnect cable from the T-4180 Control on the back of the Controller.
4. Connect the Controller Upload Cable from the COM port 2 on the PC to the T-4180 Control connector on the back of the Controller.
5. Run "PROCOMM" or equivalent.
 - a. Press "Ctrl" and "E" to set the program to echo key strokes on the monitor
 - b. Set the serial bus parameters to 8 bits, 1 stop bit, no parity, 19.2k baud, and COM 2
6. Power on the CTX System.
7. Observe on the monitor that the system is in the upload mode.
8. Follow the directions on the screen.
9. After completing the upload, disconnect the Controller Upload Cable from the CTX system.
10. Reconnect the T-4180 Control Cable to the back of the Controller.
11. Power off the CTX system.
12. Power on the CTX system.

NOTE:

Steps 10 and 11 reset the CTX system to the normal mode of operation. If these steps are not performed the CTX system will remain in the Upload mode.

3-2.2.3 PA-5050A Upload Procedure. Perform the following procedures:

1. Build a PA-5050A Upload Cable in accordance with the description provided in table 3-2.
2. Power off the CTX system.
3. Disconnect cable from the PA-5050A J5 Serial Remote connector.
4. Connect the PA-5050A Upload Cable from the COM port 2 on the PC to the PA-5050A J5 Serial Remote connector.
5. Run "PROCOMM" or equivalent.
 - a. Press "Ctrl" and "E" to set the program to echo key strokes on the monitor
 - b. Set the serial bus parameters to 8 bits, 1 stop bit, no parity, 19.2k baud, and COM 2
6. Power on the CTX System.
7. Observe on the monitor that the system is in the upload mode.
8. Follow the directions on the screen.
9. After completing the upload, disconnect the PA-5050A Upload Cable from the J5 Serial Remote connector on the PA-5050A.
10. Reconnect the PA-5050A Cable to J5 Serial Remote connector.
11. Power off the CTX system.
12. Power on the CTX system.

NOTE:

Perform steps 10 and 11 if uploading to all the PA-5050A's and you desire to reset all the PA's at one time. Otherwise, you can individually reset a PA by powering it down at the circuit breaker panel. Performing the reset procedure places the PA(s) in the normal mode of operation. If a reset is not performed the PA-5050A(s) will remain in the Upload mode.

Table 3-1 Controller Upload Cable

Pin # on a 25 Pin Female Connector (PC side)	Signal	Pin# on a 9 Pin Female Connector (T-4180 side)	Signal
2	TXD	4	RXD
3	RXD	7 5 <i>Note: Pin 7 & 5 are Jumped</i>	TXD CTS
7	GND	1	GND

Table 3-2 PA-5050A Upload Cable

Pin # on a 25 Pin Female Connector (PC side)	Signal	Pin# on a 25 Pin Male Connector for 2241-1000-3 (PA-5050A side)	Signal
2	TXD	24	RXD
3	RXD	19 22 <i>Note: Pin 19 & 22 are Jumpered</i>	TXD CTS
7	GND	20	GND

3-3 POWER ON APPLICATION & STANDARD OPERATION PROCEDURES.

3-3.1 Power On Application. To turn on, and initially set-up the CTX-5000 System, perform the following procedures:

1. Apply input power to the equipment from the power supply. (Turn the POWER switch to ON (up) on both power supplies.)
2. Apply input power to the T-4180. (Turn the POWER switch ON (up))
3. Observe PWR LED on each PA-5050A chassis, and all four PA modules light.
4. The CTX System is remotely controlled using an RS-485 bus connected to the exciter.

NOTE:

Refer to the section 3-5.2 for the appropriate Exciter Commands and Status Messages.

5. During operation, press the DISPLAY STATUS button on the front panel to cycle through the different status messages on the front panel display.
6. Observe that the FLT LED on each PA module does not light during transmission.
7. To shut down the PA-5050A remove input power. (Turn the POWER switch to OFF (down) on both power supplies.)

3-3.2 Standard Operation. Prior to transmitting, the CTX System must be tuned for the particular frequency. The following procedure explains how to tune the CTX System.

1. Select the frequency on the exciter.
2. Select PAPOW on the T-4180 exciter.
3. Select the appropriate power setting, refer to the para 3-5.1.3.
4. If operating remotely, send the PAP command, refer to table 3-4.

CAUTION

If changing frequency >10% or crossing the filter bands, the PA must be re-tuned.

5. The PA gain for each PA can be stored into channel memory to enable a return to that channel without re-tuning, refer to para 3-5.1.1.
6. Other power levels besides 5kW, 2.5kW, and 1kW may be manually adjusted by selecting the SET softkey.

3-4 EMERGENCY OPERATION. The CTX System is designed to continue operation, at a reduced power, if a partial system failure should occur to a PA-5050A or any of its modules, or if a power supply fails. A power supply failure is the same as losing three PA-5050A's. Refer to table 3-3 for the CTX System output power should a PA or multiple PA failure occur. The controller will automatically compensate for the loss of 1 to 5 PA-5050A's by reducing the output power. The following procedures explain how to operate in a reduced mode.

3-4.1 PA-5050A Failure. In the event of a complete failure of a PA-5050A, power will need to be removed from the unit. To remove power from a particular PA-5050A and replace the unit with a working PA-5050A, conduct the following procedures.

1. Locate the associated circuit breaker switches for the failed PA-5050A at the circuit breaker panel.
2. From the circuit breaker panel, pull all five circuit breakers.

WARNING

This procedure only removes the DC power to the unit. RF power may still be present, especially if the CTX System is transmitting. Opening the circuit breakers only prevents further damage from DC power. **DO NOT** attempt removing the PA-5050A from the CTX System unless the power has been secured from the two power supplies. As a secondary precaution, remove the main AC power cables from the AC power source.

3. After all power has been removed from the CTX System, detach all rear cables to the PA-5050A.
4. Swap out the unit with a working unit.

CAUTION

The working unit must be a PA-5050A that has been tuned and aligned for a CTX System. A standard PA-5050A may not be properly phased matched. Using a standard PA-5050A may cause severe damage to the unit and the CTX System.

5. Reattach all rear panel cables.
6. Close all circuit breakers to the associated PA-5050A.
7. Apply power to the CTX System.

Table 3-3 PA-5050A Failure Output Power

No. of Good PA's	Max Output Power
6	5000W
5	4000W
4	1600W
3	800W
2	400W
1	150W

3-4.2 PA-5050A Module Failure. In the event of a module failure in a PA-5050A, the module can either be shut off or swapped out with a working module while the CTX System is in an operational mode. Perform the following procedures to shut down a particular module or swap a module out with a working module.

1. From the circuit breaker panel, pull the circuit breaker for the particular PA module to be replaced.

NOTE:

Opening a circuit breaker to a specific module will deactivate that module. Once deactivated the CTX System will transmit at a reduced power out. The module does not have to be swapped out immediately.

2. Remove and replace the PA module in accordance with Chapter 5 of the PA-5050A Operation & Maintenance Manual.
3. Close the circuit breaker for the particular module that was replaced.

3-5 CTX T-4180 EXCITER DIFFERENCES. The purpose of this section is to explain the CTX T-4180 Exciter differences as compared to a stand alone T-4180 Exciter described in the T-4150/80 Technical Manual. When operating the CTX T-4180 Exciter a different Secondary Soft Key menu is displayed as shown in figure 3-1. Additionally, the function of certain CTX T-4180 Exciter Command and Status Messages operate differently.

- For a complete explanation on setting or changing the T-4180 Exciter parameters, refer to the T-4180 Technical Manual section 3-7.
- For a complete explanation of all serial buss messages used to remotely control the T-4180 Exciter, refer to section 3-8.7 of the T-4180 Technical Manual

3-5.1 Secondary Softkey Differences. The T-4180 Exciter displays a different Secondary Softkey menu when connected to the CTX System. The specific differences are the PAPOW, PASTAT, and PAGAIN softkeys. Figure 3-1 and the menus shown below explain the operation of these keys

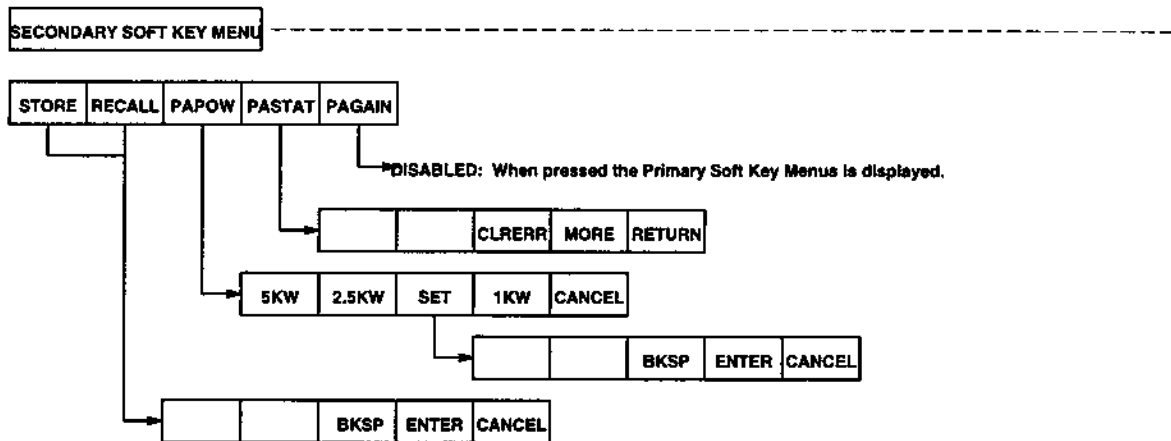

Figure 3-1 CTX T-4180 Secondary Soft Key Menu Flow Diagram

3-5.1.1 **STORE**. This function stores all current exciter parameters in a selected memory channel. All exciter parameters are first entered using the keypad and/or main adjustment knob. The memory channel is then selected and all data is copied to the memory channel.

The following parameter settings may be stored in each memory channel: frequency, power level, exciter modulation mode, audio source, bandwidth, hop rate, dwell time, and PA gain for all PA's. Refer to the T-4150/80 technical manual for a detailed description and operation.

3-5.1.2 **RECALL**. There have been no changes to this Soft Key. Refer to the T-4150/80 technical manual for its detailed description and operation.

3-5.1.3 **PAPOW**. This function allows RF power selection for the CTX-System power amplifiers.

Secondary Soft Key Menu.

STORE	RECALL	PAPOW	PASTAT	PAGAIN		
					MTR MNU	NEXT

Press the PAPOW key to show the power selections. The following menu appears.

PAPOW Soft Key Menu.

5KW	2.5KW	SET	1KW	CANCEL		
					MTR MNU	NEXT

NOTE:

When any of the above soft keys are pressed (except CANCEL or SET), the exciter and PA-5050A's are automatically keyed. The attenuator in each PA-5050A is automatically adjusted to produce the selected RF power level output.

Press the desired soft key to set the RF power output level.

PAPOW Soft Key Menu.

5KW	2.5KW	SET	1KW	CANCEL		
					MTR MNU	NEXT

Press the SET key to manually set other power output levels. The following menu appears.

PAPOW-SET Soft Key Menu

		BKSP	ENTER	CANCEL		
					MTR MNU	NEXT

Use the numeric keypad to enter the desired power output level in watts or rotate the knob on the front panel of the T-4180 Exciter. A range of 100W to 5kW can be selected. Press the ENTER soft key to activate the output. Use the BKSP (backspace) key to correct an entry.

3-5.1.4 **PASTAT.** This function causes the current status of all the PA-5050A power amplifiers to be displayed.

Secondary Soft Key Menu

STORE	RECALL	PAPOW	PASTAT	PAGAIN		
					MTR MNU	NEXT

Press the PASTAT key to show the current status of all PA-5050A power amplifiers. The following menu appears.

PASTAT Soft Key Menu.

		CLRERR	MORE	RETURN		
					MTR MNU	NEXT

Pressing the MORE key provides additional information on the display regarding the status of all PA's. The following information is displayed by pressing the MORE key.

- Initial Displayed Information: System level information regarding Frequency, Forward & Reverse power, SWR, & Combiner temperature registered from each thermistor.
- Press MORE 1st time: Forward & Reverse power, SWR, & Attenuation in each PA
- Press MORE 2nd time: Gain fault status of the Driver module & the four PA Modules in each PA
- Press MORE 3rd time: Temperature fault status of Driver module & the four PA Modules in each PA
- Press MORE 4th time: Displays system level faults of the controller and the 6 PA's in text format. Same as the ER? command, refer to table 3-4.

Press the CLRERR (Clear Error) button to clear all the indicated faults from the display.

3-5.1.5 **PAGAIN.** This function has been disabled in the CTX System. When selected the operator is returned to the Primary Soft Key Menu.

3-5.2 Remote Operation. The T-4180 may be optionally operated under remote control using a serial bus and a suitable controller. To communicate with the T-4180 remotely, the operator uses ASCII encoded messages. Each message that can be sent from the bus controller is listed in section 3-8.7 of the T-4150/80 manual. Command Status Messages listed in table 3-4 below define the messages that are particular to the CTX System. Messages that are similarly listed in section 3-8.7 of the T-4150/80 manual are non-operational in the CTX System.

Table 3-4 CTX T-4180 Exciter Command and Status Messages

Command	Reply	Description
ER?	ER000 000 000 000 000 000 000	The first 000 contains errors specific to the controller followed by each PA, 1 through 6. Each 000 may contain a value from 0 to 256 where the value represents a binary flag for specific errors. These values are: 0 = No error 1 = Serial Communications Error 2 = SWR Error 4 = Gain Fault Error 8 = Temperature Fault Error 16 = Combiner Temperature Error (Valid for the first error value only) 32 = Minimum Attenuation Fault (A unit failed the minimum output power during a power set command. 64 = Reserved 128 = Reserved
TEM?	TEM000 000 000	Where: 000 represents the Temperature of the three sensors in the combiner in degrees C. These are used for protective shutdown should the combiner overheat.
IDP?	CTX-5000 Ver X.xx MM/DD/YYYY	This is the product ID response including S/W version and date. Note The PA's now support this command also.
PA?	PAF, FWD, REV, SWR, ATN, TEM, & KEY	Request poweer amplifier status message. This will reply with a complete status message of all settings ad described below: PAF = PAFnnnnnnnn (frequency in 10's of HZ) FWD = nnnn nnnn nnnn nnnn nnnn nnnn where: The 1 st set of n's is the total Forward power in watts 2 nd thru 7 th set of n's are the Forward power, in watts, for each PA REV = REVnnn nnn nnn nnn nnn nnn where: The 1 st set of n's is the total Reverse power in watts 2 nd thru 7 th set of n's are the Reverse power, in watts, for each PA SWR = SWRnn nn nn nn nn nn where: The 1 st set of n's is the total Standing Wave Raito 2 nd thru 7 th set of n's are the Standing Wave Ration for each PA ATN = ATNnnn nnn nnn nnn nnn where: Each set of n's is the dB for each PA TEM = TEMnnn nnn nnnwhere: Each set of n's is the temperature in °C for each thermistor in the combiner KEY = KEYnnnnnnn where n is "1" or "0" (1=keyed, 0=unkeyed): The 1 st n represents the total CTX System 2 nd thru 7 th n represents each PA
PAPXXXX		Where XXXX is a value of 100 to 5000 in watts. For 100 Watts --> PAP100 For 5000 Watts --> PAP5000

CHAPTER 4 PARTS LIST

4-1 INTRODUCTION. This chapter contains the parts list for replaceable parts at the operational maintenance level.

4-2 REPLACEABLE PARTS LIST. Table 4-1 lists the replaceable parts for the unit. (See figure FO-3 for locations.)

Table 4-1 CTX 5000 Replaceable Parts List.

Item #	Description	Part Number	Qty
1	Panel, Blank, 19", 1U	259-035	3
2	Combiner, 6-Way, with Directional Coupler	118-097	1
3	Circuit Breaker Panel #1 (Left Side)	2245-1101-1	1
4	Front Filler Panel	2245-4406-1	6
5	PA-5050A, Final Assembly Power Amplifier Module	2241-1000-XX ¹ 2241-1111-1	6 24
6	Circuit Breaker Panel #2 (Right Side)	2245-1101-2	1
7	Panel, Blank, 19", 2U	259-043	3
8	Control Unit	2245-1102-1	1
9	T-4180 Exciter	2607-1000-10	1
10	Power Supply 0-30V, 330A	275-014	2
11	Panel, Vent, 19" Rack, 1U	259-042	2
12	Splitter, PWR 6-Way, 1-175 MHz	118-098	1
13	AC Line Filter	077-026	1

¹ XX indicates factory installed options. Refer to Identification plate on equipment..

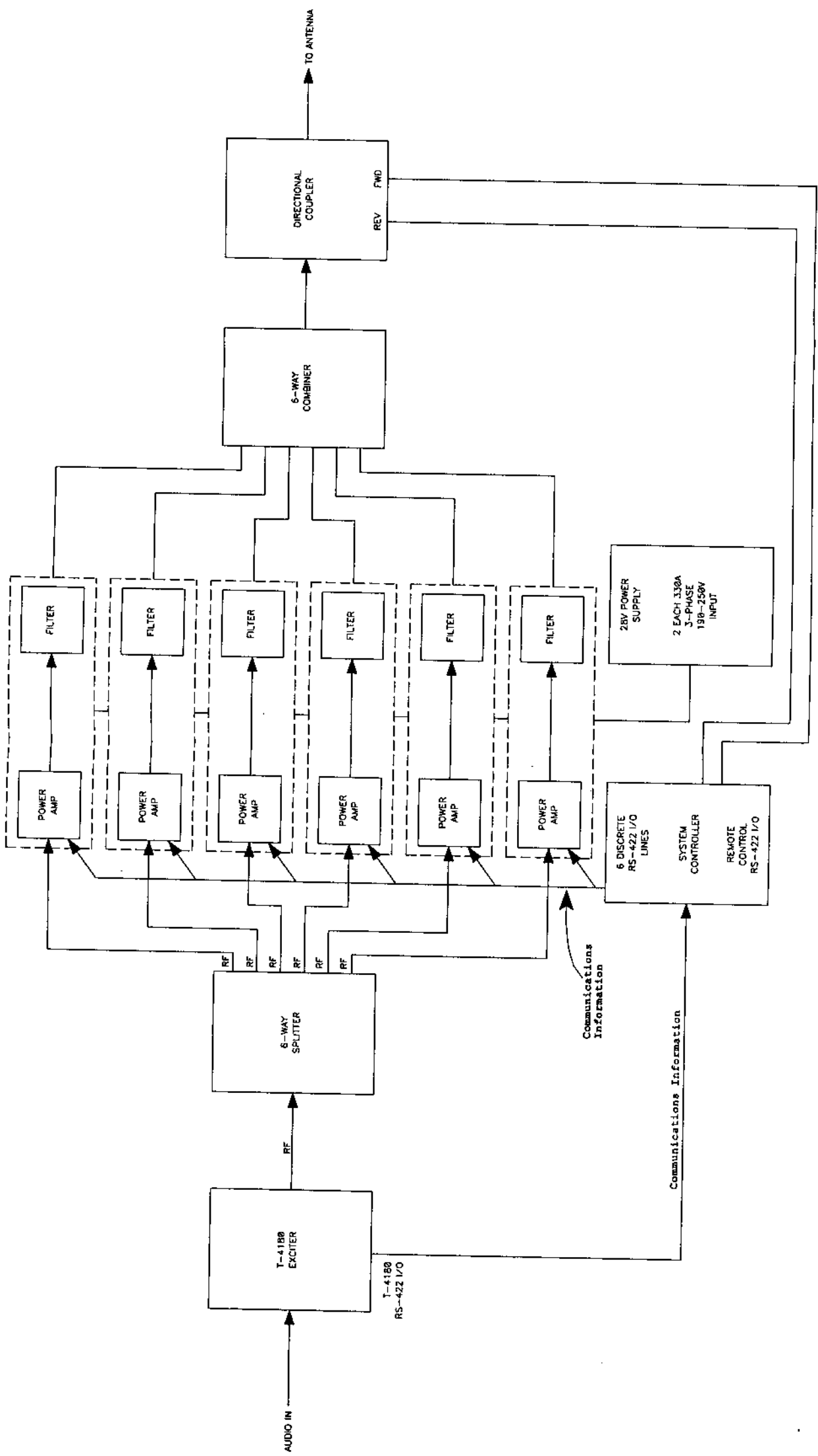

FO-1. CTX-5000 Block Diagram.

NOTES: UNLESS OTHERWISE SPECIFIED

1.  INDICATES HANDED BY CONDUCTORS IN CHARGE.
2. SEE SHEET 3 FOR RETAILOUT CONNECTIVITY POINTS.

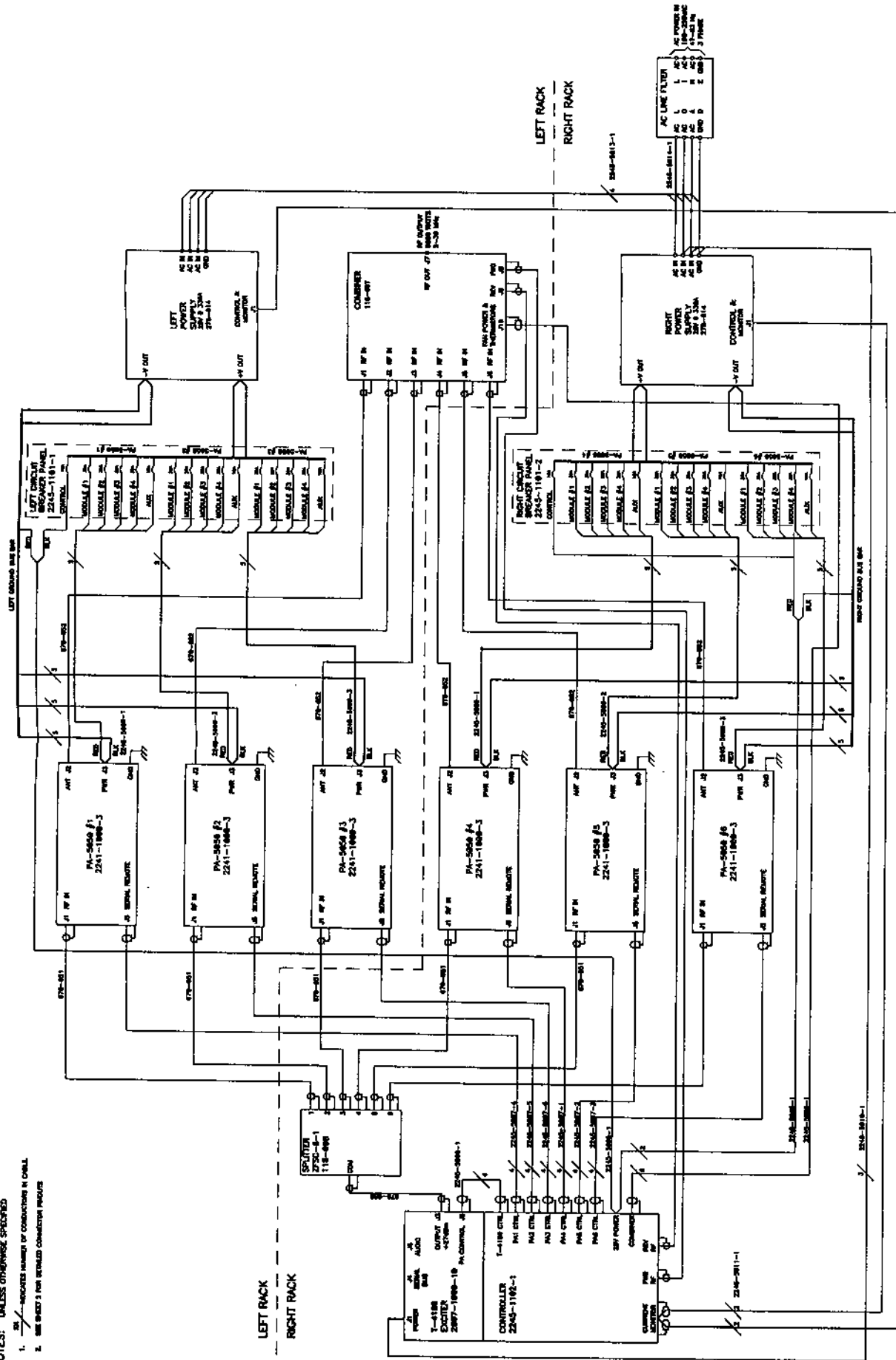

FO-2. CTX-5000 Interconnect Diagram.
 (Sheet 1 of 2).

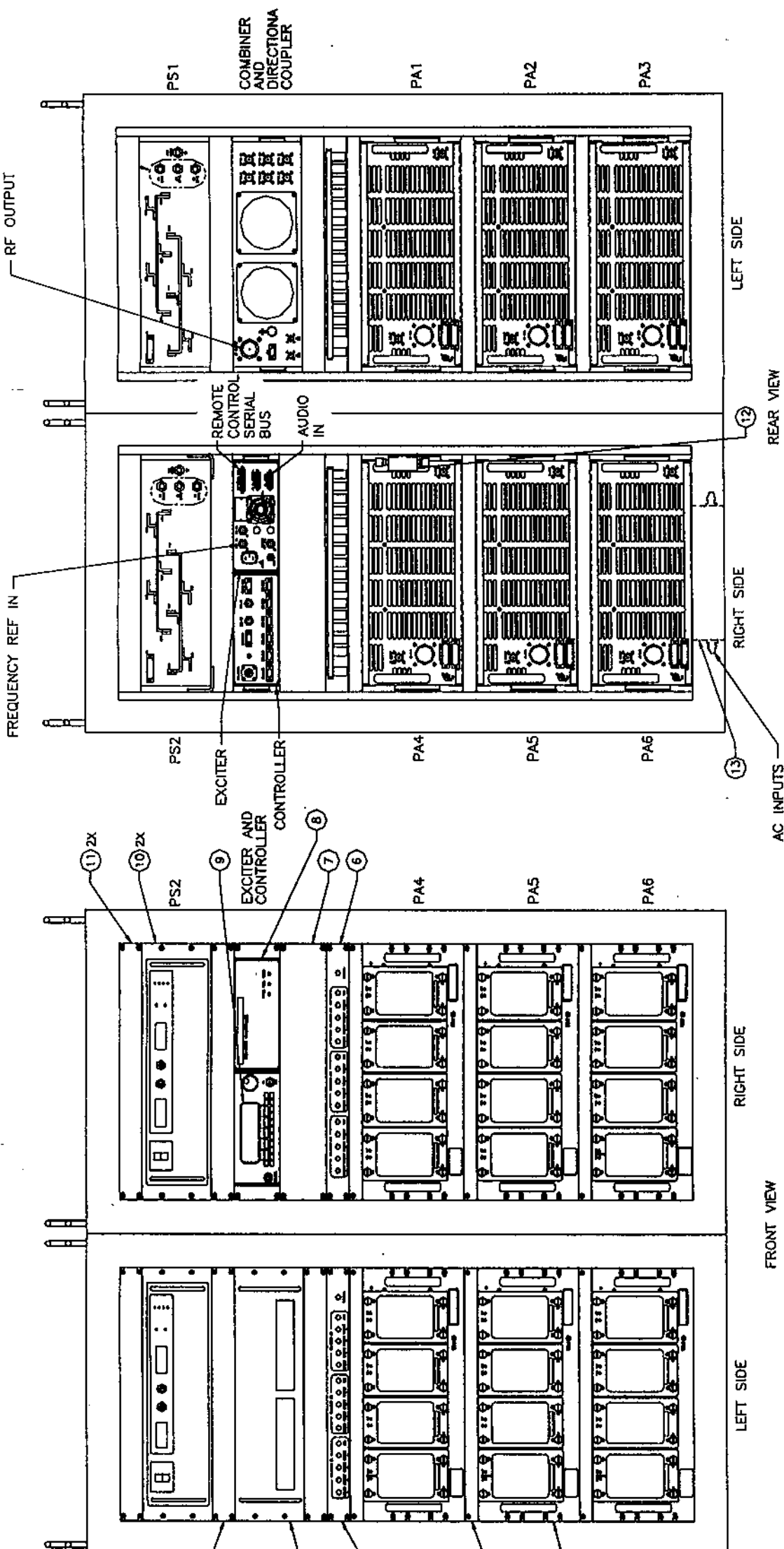

FO-3. CTX-5000 Replacement Parts Locator Diagram