

Pocket PC/POZ

User's Manual

This is a draft manual for CP-X515 model.

Copyrig |



Cyberbank assumes no responsibility for any damage or loss resulting from the use of this manual. And also Cyberbank assumes no responsibility for any damage or loss caused by deletion of data as a result of malfunction, dead battery, or repairs. Be sure to make backup copies of all-important data on other media to protect against data

The information contained in this document is provided “as is” and is subject to change without notice. Cyberbank makes no warranty of any kind with regard to this manual, including, but not limited to, the implied warranties of merchantability and fitness for a particular purpose. Cyberbank shall not be liable for any errors contained herein or for incidental or consequential damages in connection with the furnishing, performance, or use of this manual or the examples herein.

This document contains proprietary information that is protected by copyright. All rights are reserved. No part of this document may be photocopied, reproduced, adapted, or translated to another language without the prior written consent of Cyberbank, except as allowed under the copyright laws.

The programs that control this product are copyrighted and all rights are reserved. Reproduction, adaptation, or translation of those programs without prior written permission of Cyberbank is also prohibited. Microsoft, ActiveSync, MSN, Outlook, Windows, Windows Media, Windows NT, and the Windows logo are either registered trademarks or trademarks of Microsoft Corporation in the United States and/or other countries. Microsoft products are licensed to OEMs by Microsoft Licensing, Inc., a wholly owned subsidiary of Microsoft Corporation.

All other brand names and product names used in this document are trade names, service marks, trademarks, or registered trademarks of their respective owners.

CYBERBANK. CORP.

3, 4, 5th Fl. Softforum B/D Dogok-dong, Kangnam-gu, Seoul, Korea

FCC RF Exposure Information

In August 1996 the Federal Communications Commission (FCC) of the United States with its action in Report and Order FCC 96-326 adopted an updated safety standard for human exposure to radio frequency electromagnetic energy emitted by FCC regulated transmitters. Those guidelines are consistent with the safety standard previously set by both U.S. and international standards bodies. The design of POZ complies with the FCC guidelines and these international standards.

Use only the supplied or an approved antenna. Unauthorized antennas, modifications, or attachments could impair call quality, damage your POZ, or result in violation of FCC regulations.

Do not use your POZ with a damaged antenna. If a damaged antenna comes into contact with the skin, a minor burn may result. Please contact your local dealer for replacement antenna.

POZ was tested for typical body-worn operations using the optional belt-clip / holster placed 1.5cm from the body. To comply with FCC RF exposure requirements, a minimum separation distance of 1.5cm must be maintained between the user's body and POZ, including the antenna, whether extended or retracted. The use of third-party belt-clips / holsters with no metallic components that provide the minimum separation distance of 1.5cm can be used to satisfy FCC RF exposure requirements. The use of non-tested accessories or other body-worn operations may not comply with FCC RF exposure requirements and should be avoided. Contact your local dealer for optional accessory items.

For more information about RF exposure, please visit the FCC website at www.fcc.gov

Specific Absorption Rate(SAR) for Wireless Phones

The SAR is a value that corresponds to the relative amount of RF energy absorbed in the head of a user for a wireless handset. The SAR value of a phone is the result of an extensive testing, measuring and calculation process. It does not represent how much RF the phone emits. All phone models are tested at their highest value in strict laboratory settings. But when in operation, the SAR of a phone can be substantially less than the level reported to the FCC. This is because of a variety of factors including its proximity to a base station antenna, phone design and other factors. What is important to remember is that each phone meets strict federal guidelines. Variations in SARs do not represent a variation in safety. All phones must meet the federal standard, which incorporates a substantial margin of safety. As stated above, variations in SAR values between different model phones do not mean variations in safety. SAR values at or below the federal standard of 1.6W/kg are considered safe for use by the public.

The highest reported SAR values of CP-X515 are:

CDMA mode (Part 22)- Head: 0.617 W/kg; Body-worn: 0.874 W/kg

Safety Information

Please read these simple guidelines before using your phone. Failure to comply with these guidelines may be dangerous or illegal.

Do not use a hand held phone whilst driving a vehicle; park the vehicle first.

Switch off your phone when in an aircraft. The use of cellular phones whilst airborne is illegal in some countries. It may disrupt the operation of the aircraft. Follow any regulations or rules regarding air travel.

Wireless phones can cause interference. Switch off your phone near medical equipment.

Do not use your mobile phone at a petrol station or near fuel, chemicals or in any area where blasting is in progress. Observe restrictions and follow all rules and regulations.

Use the phone only in a normal manner as instructed in this manual and do not handle the antenna unnecessarily.

Only qualified service personnel must install or repair equipment. Breaking the warranty seal and opening the casing of the phone will void your warranty.

Use only approved accessories and batteries. Do not connect to incompatible products.

Avoid any contact with water and any type of moisture.

USER INFORMATION

Acknowledging Special Precautions and the FCC Industry Canada Notice

Cautions

Modifications not expressly approved by the party responsible for compliance could void the user's authority to operate the equipment.

FCC compliance Information

When used the This device complies with part 15 of FCC Rules.

Operation is subject to the following two conditions:

1. This device may not cause harmful interference, and
2. This device must accept any interference received.

Including interference that may cause undesired operation.

Information to User

This equipment has been tested and found to comply with the limits for a Class B digital device, Pursuant to part 15 of the FCC Rules. These limits are designed to provide reasonable protection against harmful interference in a residential installation.

This equipment generates, uses and can radiate radio Frequency energy and, if not installed and used in accordance with the instructions, may cause harmful interference to radio communications.

However, there is no guarantee that interference will not occur in a particular installation. If this equipment does cause harmful interference to radio or television reception, which can be determined by turning the equipment off and on, the user is encouraged to try to correct the interference by one or more of the following measures:

- Reorient or relocate the receiving antenna.
- Increase the separation between the equipment and receiver
- Connect the equipment into an outlet on a circuit different from that to which the receiver is connected.

Consult the dealer or an experienced radio/TV technician for help.

Contents

1 | About Device 1-1

What's in the Box	1-2
Hardware Features	1-3
Using the Stylus	1-10
Soft Reset & Hard Reset	1-11
Microsoft Pocket PC Software	1-12
Where to Find Information	1-13
Using Help on Your Device	1-13
Using This Manual	1-13

2 | Getting Started 2-1

Powering up device	2-2
Connecting to your device	2-4
Complete the Welcome wizard	2-6
Using Today Screen	2-11
File Explorer	2-17
Managing Memory	2-20

3 | Using Input Panel 3-1

Using Input Panel	3-2
Block Recognizer	3-3
Keyboard	3-4
Letter Recognizer	3-5
Transcriber	3-6

4 | Connecting to Desktop 4-1

Install Microsoft ActiveSync and establish a partnership	4-2
Full Backup & Restore using Backup/Restore of ActiveSync	4-16
How to install programs using ActiveSync	4-19

5 | Configuring Device 5-1

Settings	5-2
----------	-----

6 | Using the Internet & E-mail 6-1

Browsing the Web on your device	6-2
Sending and Receiving E-mail Messages	6-7
Connecting Directly to E-Mail Server	6-14

7 | Using the Mobile Phone 7-1

Phone Program 7-2

SMS(Short Messaging Service) 7-

8 | Applications 8-1

POZ Launcher 8-

POZ MusicBox 8-

POZ Camera 8-

POZ Camcorder 8-

POZ Album 8-

9 | Microsoft Pocket Outlook 9-1

Calendar: Scheduling Appointments and Meetings 9-2

Contacts: Tracking Friends and Colleagues 9-8

Tasks: Keeping a To-Do List 9-12

Notes: Capturing Thoughts and Ideas 9-15

10 | Microsoft Programs 10-1

Microsoft Pocket Word 10-2

Microsoft Pocket Excel 10-5

Microsoft Windows Media Player 10-7

Using Terminal Services Client 10-12

Pictures 10-15

MSN Messenger 10-24

11 | Support & Service 11-1

Web Site 11-1

Service 11-1

Appendix

A. Hardware Specifications A-1

B. Warranty B-1

C. Glossary C-1

D. USB Modem Driver D-1

Chapter 1

About Device

Congratulations on purchasing PDA (personal digital assistant/model CP-X515) device powered by Windows Mobile 2003 Second Edition. Your device lets you keep your most important business and personal information current and close at hand. Your device includes Microsoft Pocket PC Software 2003 second edition, which includes the latest version of Microsoft Pocket Outlook®, so you can read and write e-mail while on the road and manage your appointments and contacts. You will find that your device is also the perfect companion to your desktop or notebook PC, allowing you to take vital business data and documents with you and easily upload updated information. The device offers you the highest quality in performance and power management as well as rich programs and utilities designed by Cyberbank.

In this chapter you will find followings :

- What's in the Box?
- Hardware Features
- Using Stylus
- Soft Reset & Hard Reset
- Microsoft Pocket PC Software
- Where to Find Information
- Using Help on your device
- Using This Manual



The information contained in this document is provided “as is” and is subject to change without notice.

What's in the Box?

Your device package includes the following items:



Device



Cradle



Battery (slim & standard)

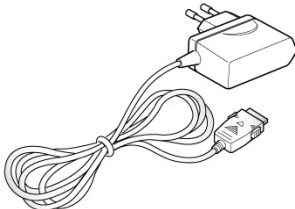

AC Adapter

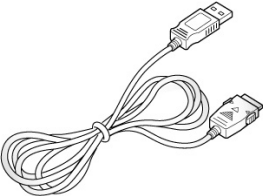

USB Cable



Ear-Phone

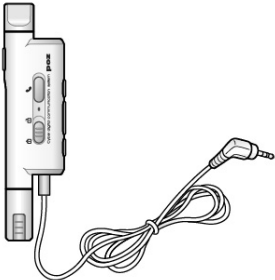

Remote Control

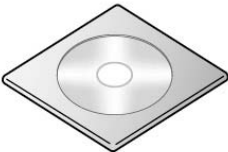

Companion CD

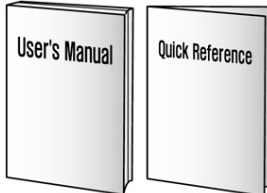

User Manual & Quick Reference



Screen Cleaner Hand Strap





Fancy Metal Hand Strap



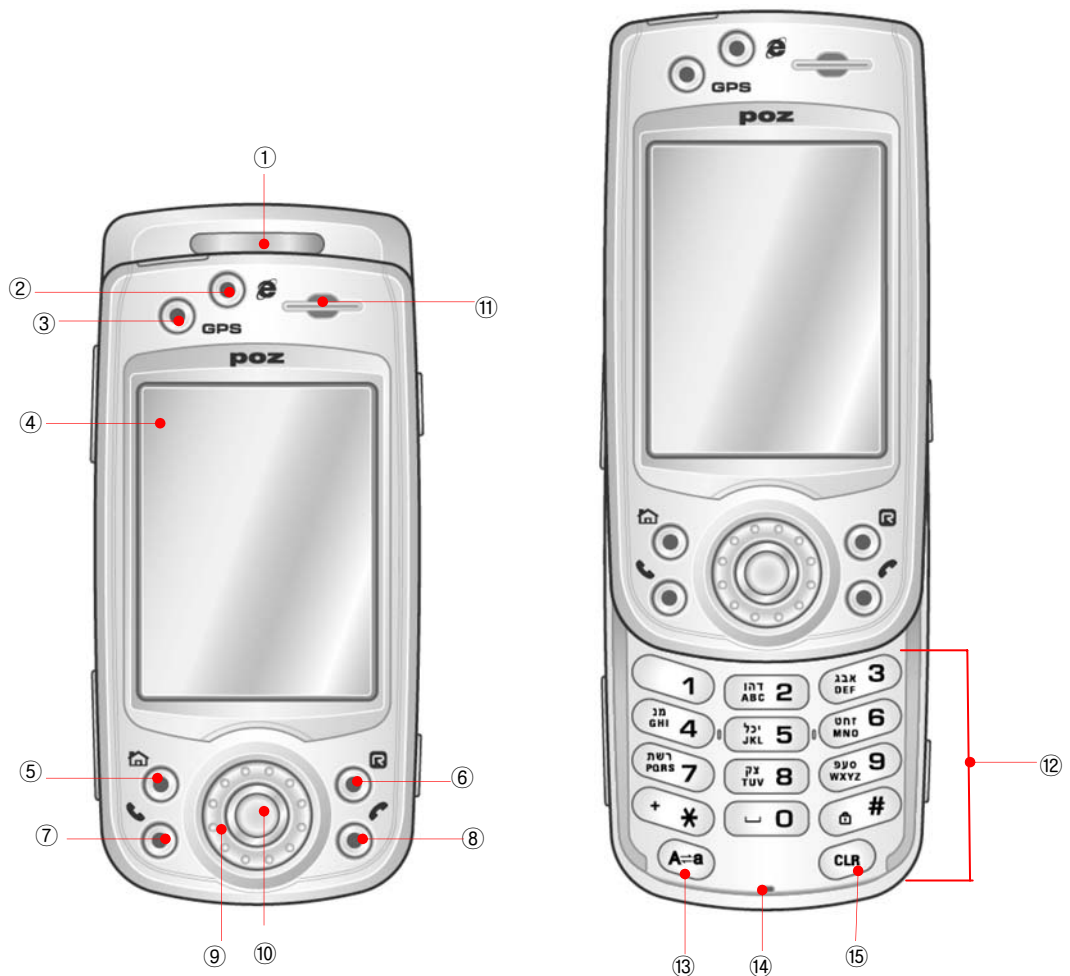

Hardware Features

The illustration below introduces you to the various buttons and other features of your device.

Front





1. Phone state LED: It flashes when a phone-call comes in and displays the state of mobile phone. It notifies you of phone state including SMS.
2. Internet Explorer Key(): allows you to open Internet Explorer.
3. GPS Key(**GPS**): allows you to open GPS program.
4. Touch screen(TFT LCD): Tap on-screen controls or buttons to select menu commands or input text.

5. Home Key() : allows you to open POZ Launcher.
6. Rotate Key() : allows you to open POZ Rotate program.
7. Send() button : allows you to make a call. Press it once to have the last called phone number displayed on the phone display with the phone program on.
8. End() button : allows you to end a call.



Home Key, Rotate Key, Send Key and End Key include Charging State LED. Charging state LEDs indicate power state while recharging.
(Blue : fully charged, Red : currently charging)

9. Wheel button : allows you to rotate and push down top/bottom/left/right.
10. Action button : allows you to open the selected item.
11. Receiver: allows you to hear the voice while talking over the phone.
12. Phone keypad : allows you to input the phone number.
13. Mode changing key() :allows you to change input mode(number, capital letter, and lower letter) of your keypad.
14. Microphone: allows you to speak into the microphone to record voice notes and communicate on the mobile phone.
15. Clear key() : allows you to delete the characters you input before. When you hold down the delete key, all characters you have input will be deleted.

Left Side

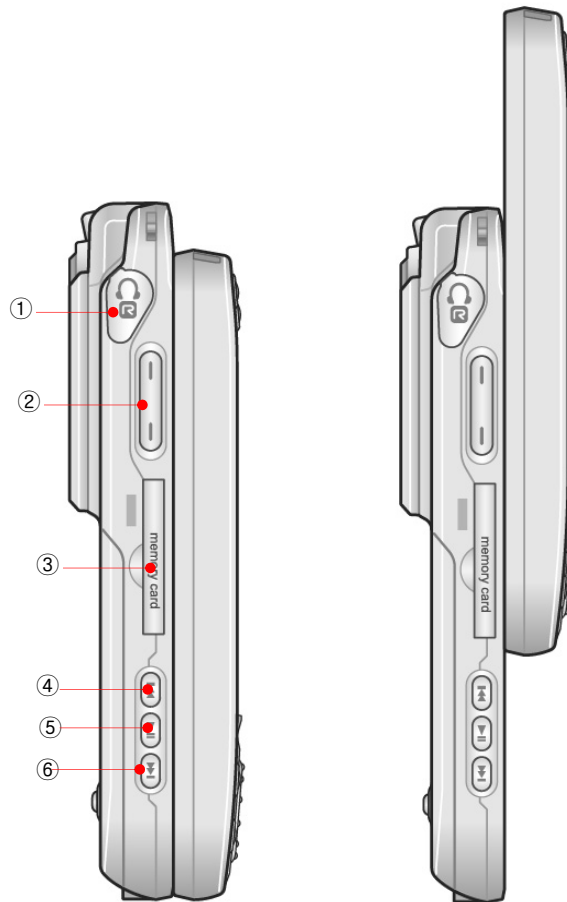

1. Stereo earphone jack: Connect a proprietary stereo earphone.
2. Up/down control button: Scroll through documents.
3. Mini SD (Secure Digital) card slot: Insert an optional mini SD card to add memory. Lift the memory card cover and slide the card into the slot gently but firmly until it snaps into place in the slot.
4. mp3 previous button : when pressed down, it allows you to move to the previous track in the POZ music box.
5. mp3 play/pause button: allows you to open POZ Music program. Also when pressed down, it could play or pause the music.
6. mp3 next button: when pressed down, it allows you to move to the next track in the POZ music box.

Right side

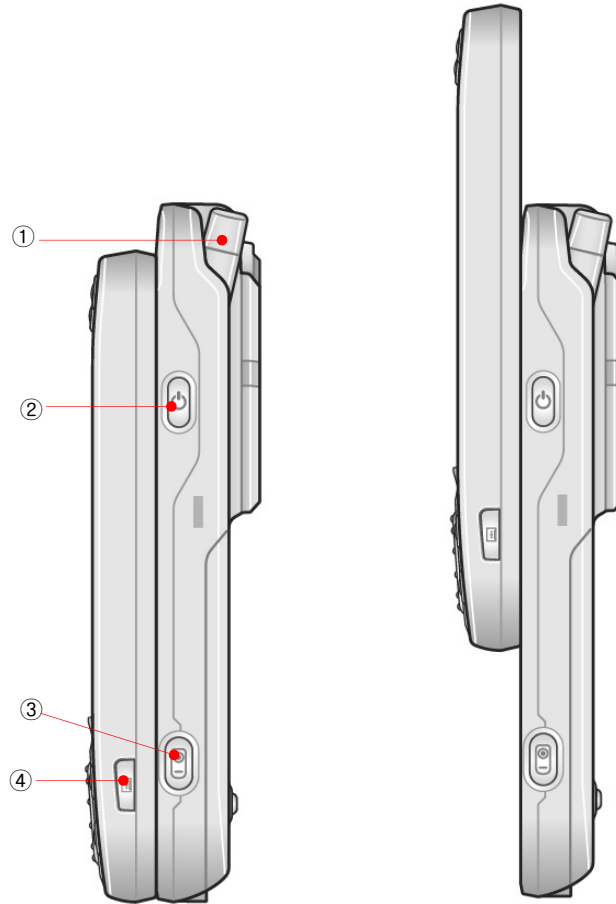

1. Antenna
2. Power button: Press to turn your device on and off.
3. Camera button: allows you to open POZ camera program and snap a picture.
4. Record button: allows you to open the note program which provides you with recording functions.(Press the Camera button to record communications between you and your partner while on the phone.)

Upper

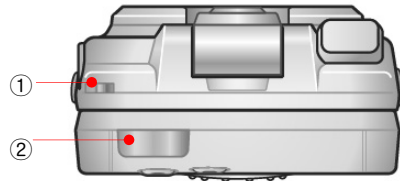

1. Hand strap
2. Infrared port: Beam files to other mobile devices.

Bottom

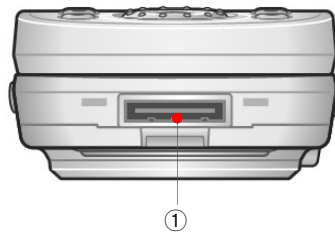

1. USB port: Connect to your desktop PC using the supplied cradle, or directly through an optional sync cable.

Rear

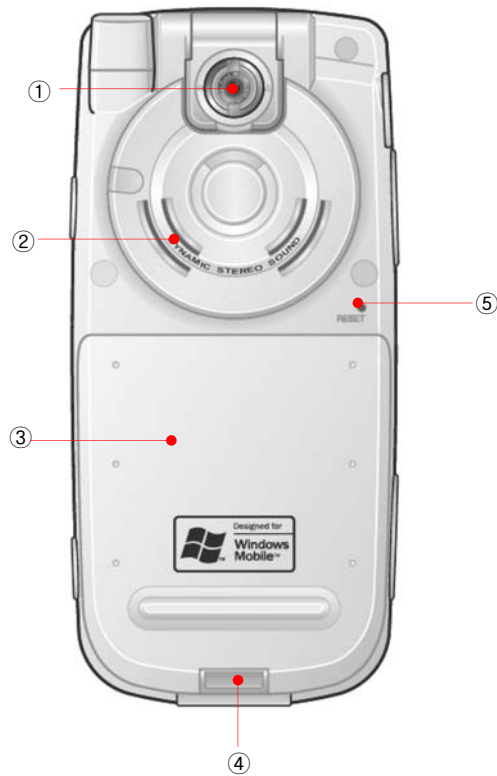

1. Swivel Camera Lens : allows you to make a digital shot with 1.3M pixels.
2. Dual stereo speaker : allows you to listen to music or set audible reminders and alerts and hear the voice while communicating on the mobile phone.
3. Main battery(690 or 1380 mAh). The main battery may be drained during the transportation from the factory to the user; therefore you should connect AC power to the cradle and place device in it in order to charge the battery when using your device for the first time.
4. battery release tab
5. Soft Reset switch: Use the stylus to press the reset switch and restart your device so that all your unsaved files will be deleted.

Remote Control

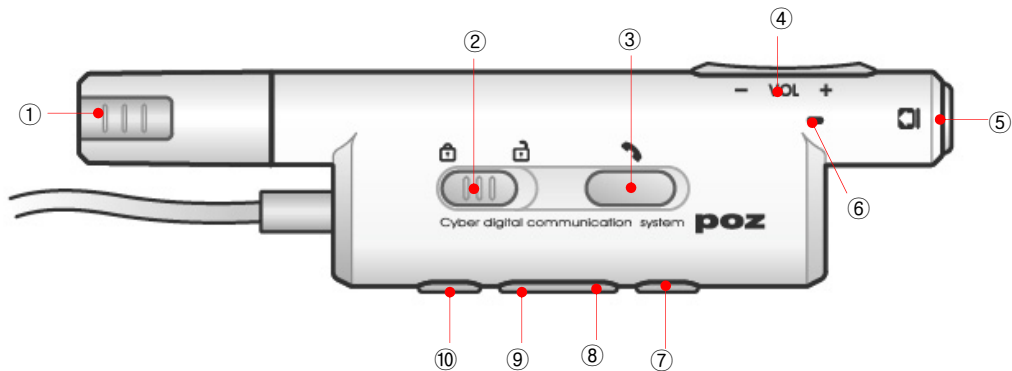

1. Stylus: Use the stylus to navigate on the touch screen.
2. HOLD : while POZ MusicBox program is open, push it to the left side not to operate other function buttons, except SEND/END button when you get the incoming call.
3. SEND/END button : press this button to receive the incoming call and press it again to end the call.
4. volume
5. Screen toggle button : allows you to control the LCD screen.
6. Microphone
7. Next button : allows you to move to the next track in the POZ MusicBox program.
8. Playback/Pause button : allows you to playback or pause temporarily in the POZ MusicBox program.
9. Stop button : allows you to stop in the POZ MusicBox program.
10. Previous button : allows you to move to the previous track in the POZ MusicBox program.

Using the Stylus

Use the stylus to navigate and select objects on the screen.



Tap

Touch the screen once with the stylus to open items and select options.



Drag

Hold the stylus on the screen and drag across the screen to select text and images. Drag in a list to select multiple items.



Tap and hold

Tap and hold the stylus on an item to see a list of actions available for that item. On the pop-up menu that appears, tap the action you want to perform.

Soft Reset & Hard Reset

When your device is running slow or improperly, use the stylus to press the Reset switch located on the rear of your device. This is called “Soft Reset” in this manual. When you perform Soft Reset, you will lose all unsaved data. Be sure to save all data in opened documents or programs beforehand. This is similar to pressing the Reset button on your desktop.

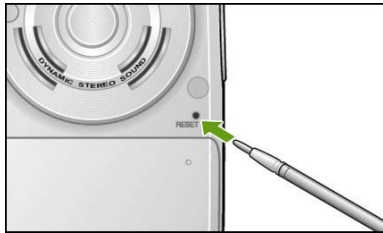

To perform Hard Reset, you have to do as follows :

1. Detach the battery first
2. Press the power button located on the right side of your device and press down the Reset switch with stylus at the same time.

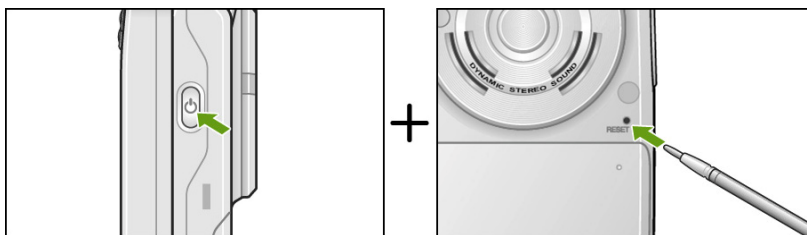

3. Attach the battery.

When you perform Hard Reset, you will lose all information that is stored in the RAM. However, File Store folder, which is one of the NAND flash memories, will not be deleted even after performing Hard Reset.



Be sure to save all data using ActiveSync or the Backup utility before you perform Hard Reset.



Use only the stylus provided by Cyberbank.

Microsoft Pocket PC Software

Your device already includes the full suite of software you need to function as a mobile professional. These programs are introduced below.

Detailed information can be found in later chapters.

The programs listed below are preinstalled in Flash ROM. These preinstalled programs will not be deleted if your device suffers a loss of power.

 **ActiveSync.** Synchronize information between your device and desktop computer.

 **Calendar.** Keep track of your appointments and create meeting requests.

 **Tasks.** Keep track of your to-do list.

 **Contacts.** Keep track of your friends and colleagues.

 **Notes.** Create handwritten or typed notes, drawings, and recordings.

 **Inbox.** Send and receive e-mail messages from your device.

 **Pocket Word.** Create new documents or view and edit Word documents created on your desktop PC.

 **Pocket Excel.** Create new workbooks or view and edit Excel workbooks created on your desktop PC.

 **Microsoft Pocket Internet Explorer.** Browse the Web and view channels and subscription content.

 **MSN Messenger.**¹ Send and receive instant messages with your MSN® Messenger contacts.

 **Microsoft Windows Media Player for Pocket PC.**² Play audio and video clips on your device. Windows Media™ Player lets you play songs and video files that have been recorded in the MP3 or WMA formats.

¹ Requires an account with an Internet service provider.

² Check the Microsoft Mobile Devices Web site for updates to Windows Media Player, including details on support for video file formats and streaming audio and video capabilities.

Where to Find Information

ActiveSync & Acrobat Reader

You can install ActiveSync 3.8 from the provided Companion CD. In case that you lose the companion CD, download and install the latest ActiveSync 3.8 on www.microsoft.com/mobile/pocketpc/download on your desktop PC. Also you can download Acrobat Reader from www.acrobat.com.

Using Help on Your Device

You can get help for specific programs and for Microsoft Pocket PC software by tapping **Help** on the **Start** menu.

Using This Manual

This User's manual is designed to help you get started using your device quickly and easily. Although great care has been taken to ensure the accuracy of procedures and artwork, some of the screens displayed on your device may be a little different from the ones that appear in this User's manual.

This User's manual includes certain visual cues that will help you find the information you want easily.



Notes : Helpful information related to the topic.



Notice : This is important information that should be observed to prevent loss of data or damage to your device.

Chapter 2

Getting Started

This chapter will help you start using your device. You will become familiar with the hardware and learn how to set up your device. When you finish this chapter, you will have all the information you need to begin working with your device.

In this chapter you will find followings :

- Power up device
- Connecting to your device
- Complete the Welcome Wizard
- Using Today Screen
- File Explorer
- Managing Memory



The information contained in this document is provided “as is” and is subject to change without notice.

Powering up device

Main battery(Li-Polymer)

The lithium-polymer battery pack provides power to your device while it is not connected to ac power. Actual battery life will vary depending on how you use your device. Some functions, such as listening to music, using the backlight, or operating mini SD cards, use considerable power and may reduce this time significantly.

The battery is charged whenever your device is connected to an ac power source—either the AC adapter or the USB cradle. Usually, it takes 3 hours to charge your battery fully depending on the battery status. Connect your device to AC power or place it in the cradle when it is not in use, to ensure that the battery is fully charged when you need to take it with you. When the battery is fully charged, charging stops automatically; the battery will not overcharge even if it is left upon being connected to AC power.

This is how the main battery is inserted. As shown below, push up the main battery until it locks in place.

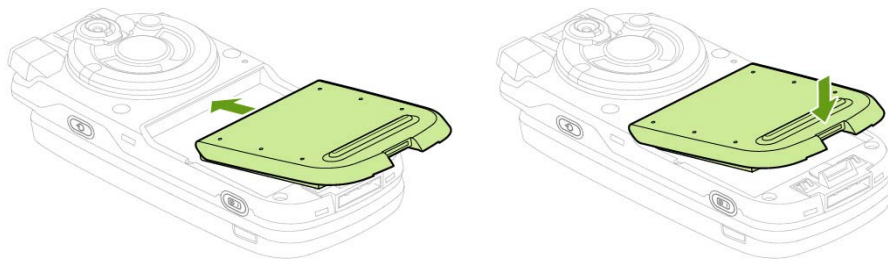

This is how it detaches.

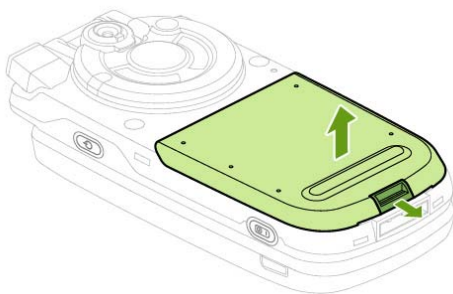

The main battery may be drained during the transportation from the factory to the user; therefore you should connect AC power to the cradle and place device in it in order to charge the battery when using your device for the first time.

AC Power with Cradle

To avoid running out of battery power, you can operate your device on AC power using the supplied AC adapter. The AC adapter accepts 100 V to 240 V, enabling you to connect to AC power anywhere in the world. When you travel, you may need adapters to accommodate different electrical outlets, but the AC adapter will safely convert AC line voltage to the DC voltage required by your device.

While your device is connected to AC power, the battery is charged automatically. The color of the LED indicates the state of the battery:

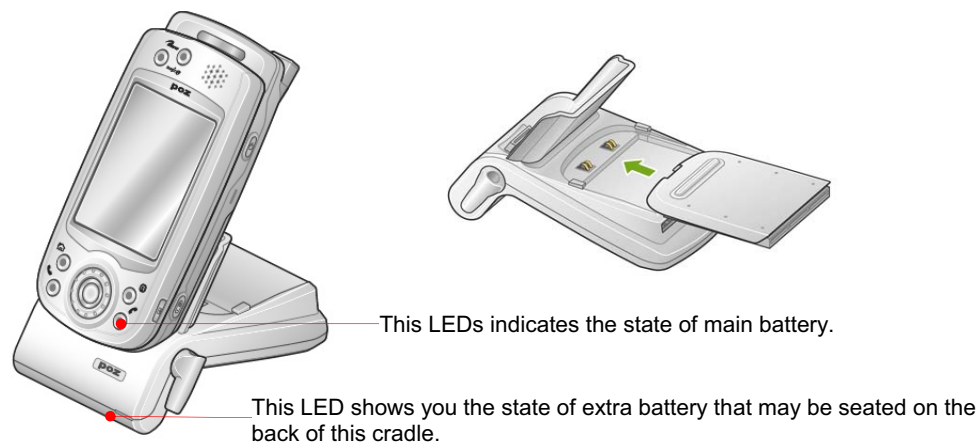

Red LED indicates that the battery is charging, and blue LED indicates that the battery is fully charged.

Power Tips

- ⦿ Follow these tips to ensure the longest use of your device between charges:
 - **Turn off the display manually.**
If you are playing music or using other functions that do not require the display, turn off the display by pressing and holding the power button.
 - **Turn off sounds.**
Use the settings to mute the speaker, or use the Sounds & Notifications settings to turn off all but the most necessary system sounds.
 - **Avoid using mini SD card while on battery power.**
Most mini SD cards use considerable power and will quickly drain your battery.

Connecting to your device

While your cradle does not include the charging circuit, it contains two ports for charging cable and USB cable as shown below.

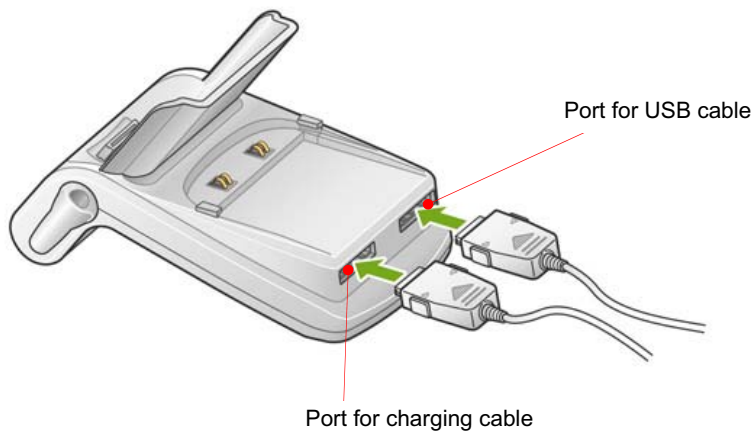

Connect power to power cable and connect USB cable to the USB port of your desktop PC as shown below.

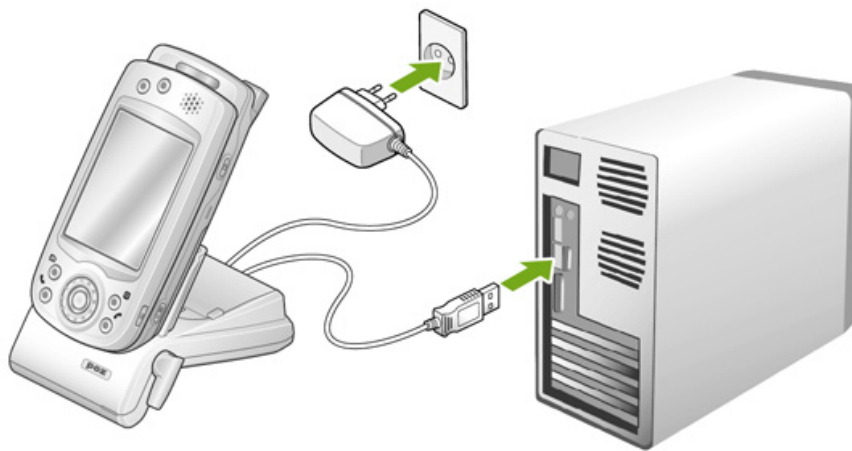

Before you connect to your device, see if your desktop PC is on and Microsoft ActiveSync program is installed from companion CD.

Your device can be connected to power directly without cradle as shown below.

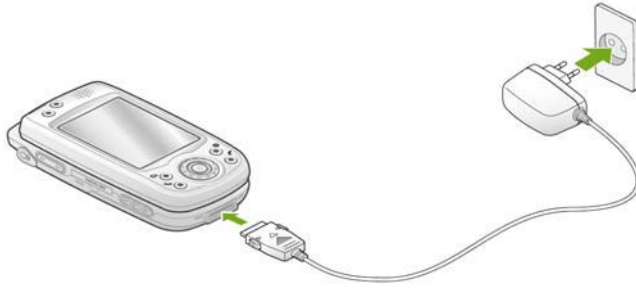

Windows 95 and Windows NT version don't support beaming connection.

Complete the Welcome wizard

Follow the steps in this section to start your device for the first time or after performing hard-reset.



Gently touch the screen with stylus. From now on, it is called “tap”.

align screen

Tap the target firmly and accurately at each location on the screen. The target will continue to move until the screen is aligned.



A target (+) will move in the order of “center → upper left → lower left → lower right → upper right” on your screen. Since calibrating the touch screen has a direct affect on the recognition ability of your touch screen, be sure to accurately tap the center of the target (+) with your stylus.

stylus

Single-tap an item to select it.
Tap and hold an item to see a menu.

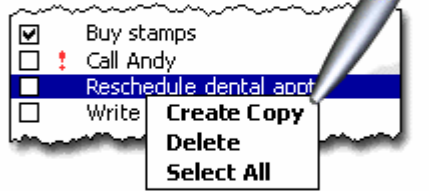

This is the way of how to single-tap and tap and hold, tap the Next button.

pop-up menus

Try it: **Tap and hold** the 9 A.M. dental appointment, and then tap **Cut** on the pop-up menu.

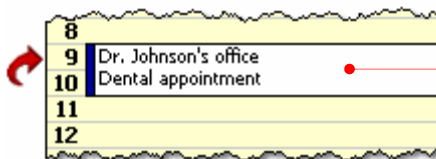

Tap and hold this location to have next window.

pop-up menus

Try it: **Tap and hold** the 9 A.M. dental appointment, and then tap **Cut** on the pop-up menu.

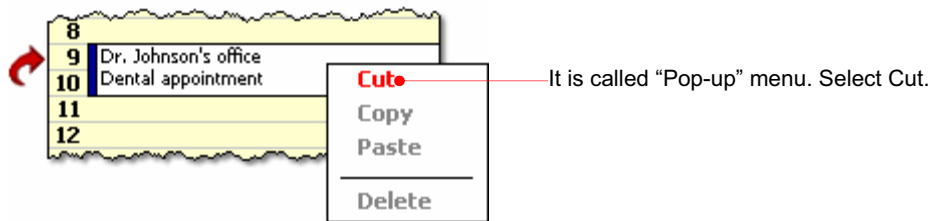

pop-up menus

Now **tap and hold** 11 A.M. and then tap **Paste** on the pop-up menu.

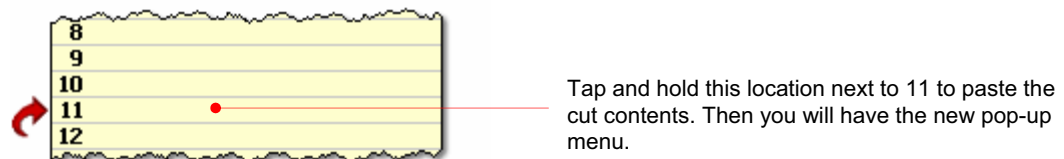

pop-up menus

Now **tap and hold** 11 A.M. and then tap **Paste** on the pop-up menu.

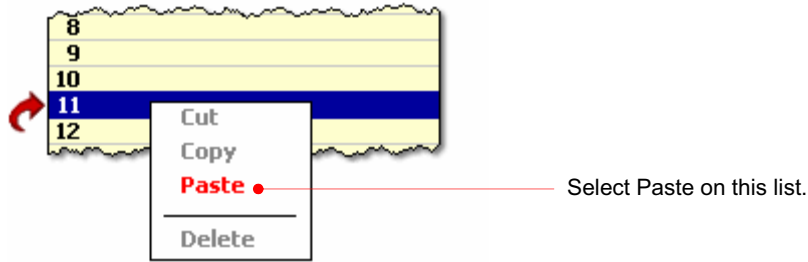

pop-up menus

Congratulations! You have rescheduled the appointment using pop-up menus.

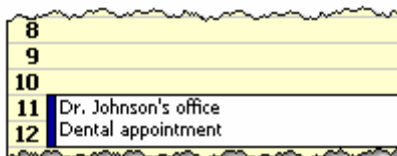

Next • The pasted contents have appeared. Tap the Next button.

location

Select your time zone:

Time zone:

Select a time zone you stay from the drop-down list box.

Next

complete

Setup is complete. Tap the screen to begin using your device.

Tap the screen to finish the Welcome wizard.

Using Today Screen

After finishing the Welcome wizard, put your device on the cradle connected to your desktop PC to automatically synchronize through Microsoft ActiveSync so that you have the next screen.

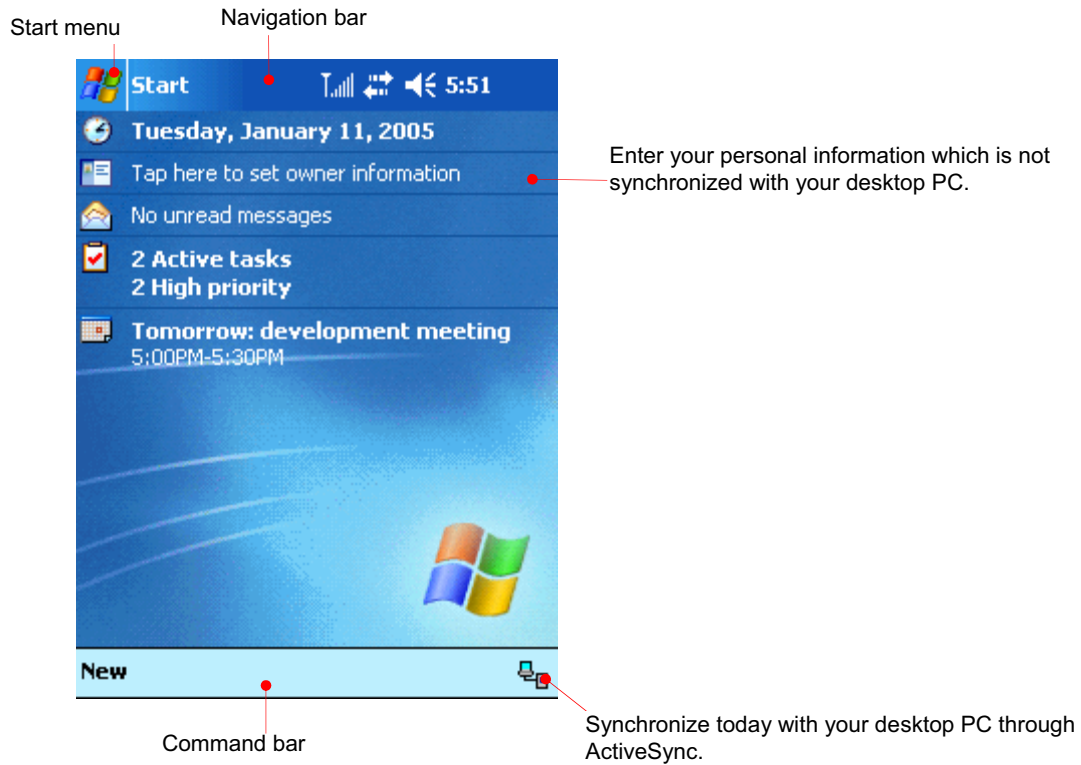

User Information

Now, you are ready to enter Owner information. Tap Owner information to have next screen.

Settings 5:53

Owner Information

Name:

Company:

Address:

Telephone:

E-mail:

Identification Notes Options

Tap any text box where you want to enter information to have input panel displayed. For more detailed information on input panel, see chapter 3.

Tap OK to save the current screen.

Settings 5:54

Owner Information

Notes:

Identification Notes Options

123 1 2 3 4 5 6 7 8 9 0 - = <

Tab q w e r t y u i o p []

CAP a s d f g h j k l ; ' <

Shift z x c v b n m , . / <

Ctl á ü ` \ < >

special characters

Settings 5:54

Owner Information

When the device is turned on, display:

Identification information

Notes

Identification Notes Options

Volume

Tap the speaker icon on the navigation bar to control the volume.

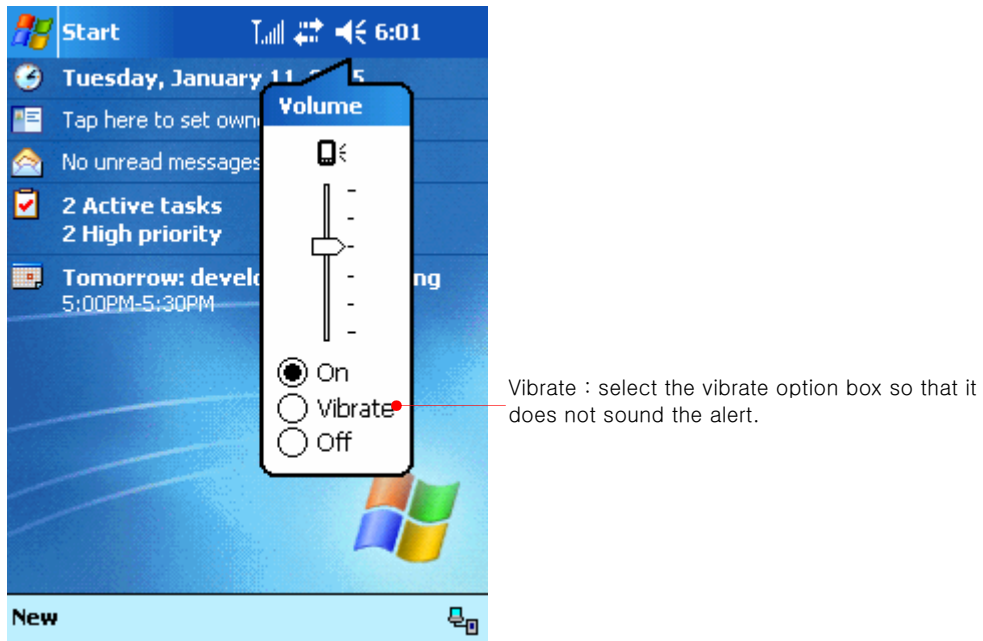

Time

Tap the time icon on the navigation bar to have the information on date, time and assignments displayed.

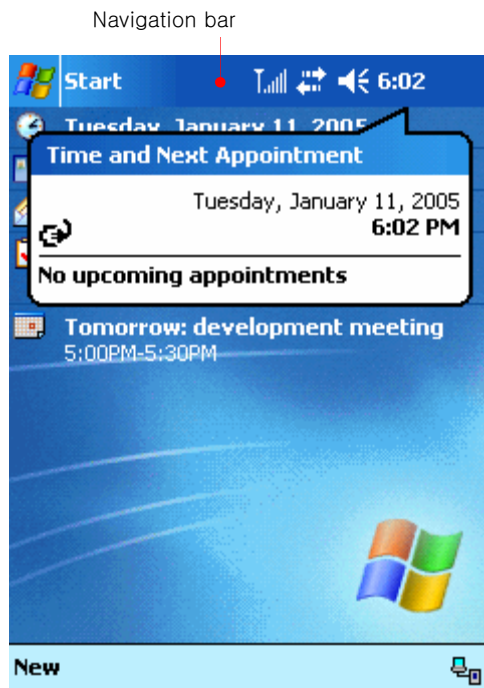

Tap the date shown below the navigation bar.



Select the time and date.
For example, select the arrow beside date.

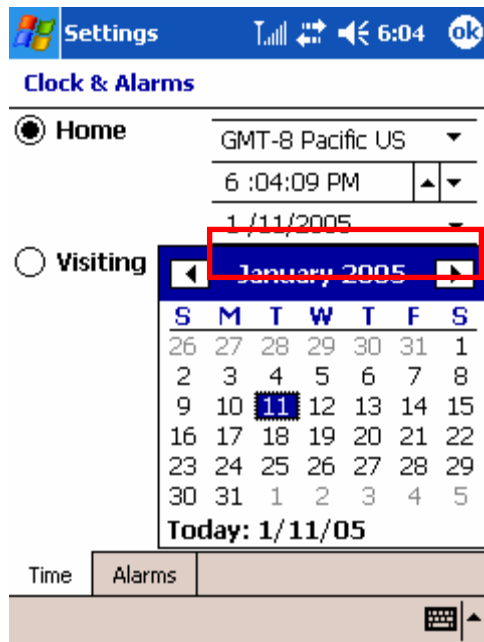

You can change the date you want here.

Open the recently used program & start the program you want

1. Tap the Start  menu.
2. Select the program you want from the list on the Start menu or select the program from the recently used programs.

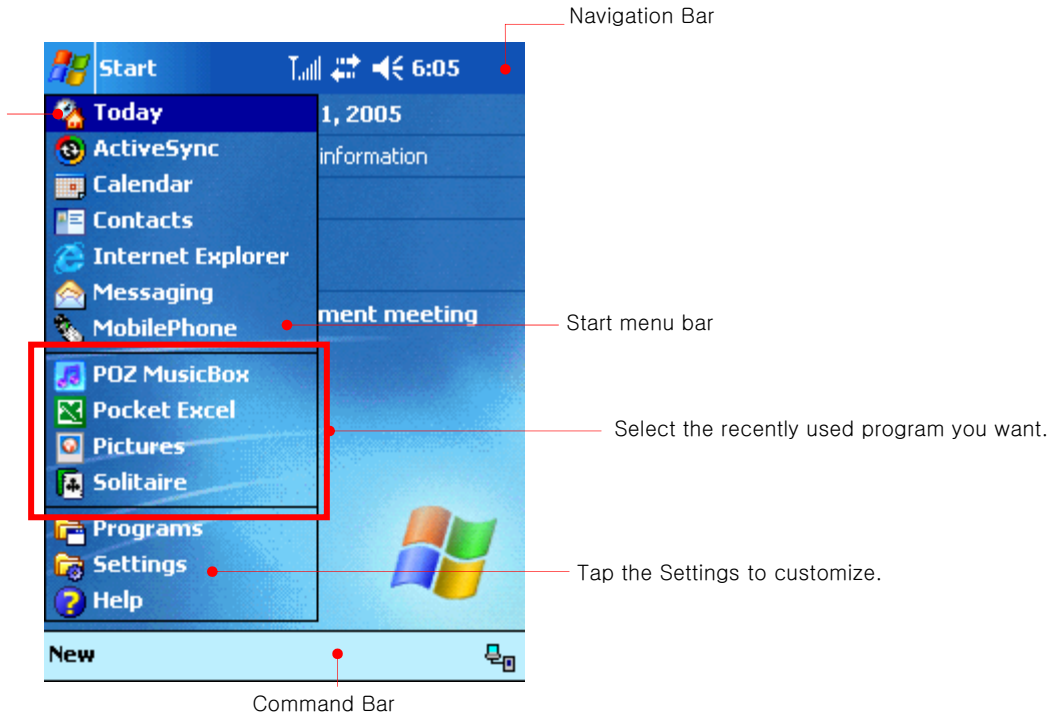

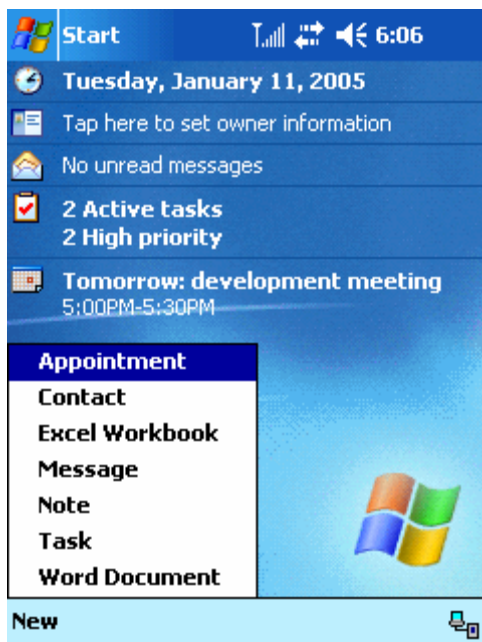

Open program directly you want from the Todays screen

Tap “New” on the Command bar to open the frequently used program from the Todays screen.



Select the program you want to open the corresponding program.

Tap Start  > Settings > Personal tab > Menu  icon to customize the Start menu and the New menu in advance.

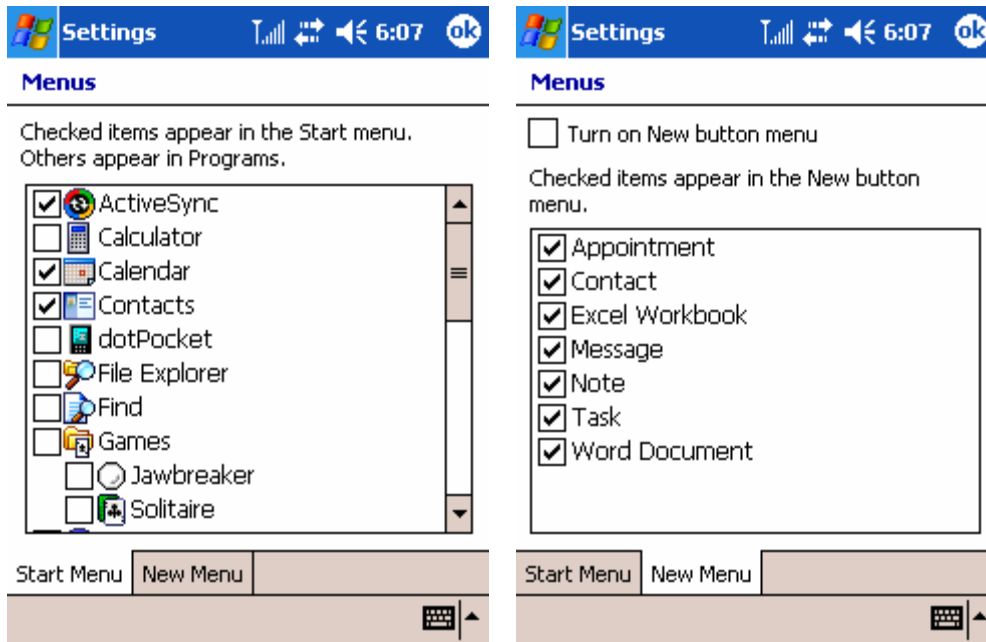

Tap OK to save these settings.

File Explorer

This File Explorer of your device is similar to Window Explorer of desktop PC.

Select the Start menu > Programs > File Explorer.

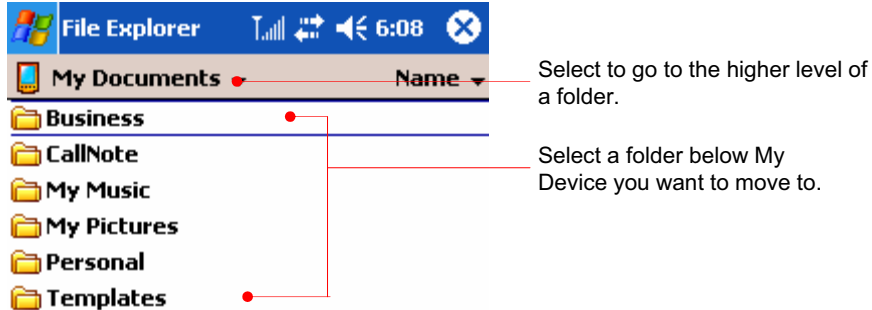

View the contents of mini SD(Secure Digital) card

Insert mini SD cards into the mini SD card slot so that Storage Card folder appears. Tap this folder to view the contents of mini SD card.

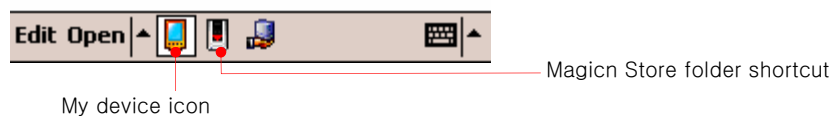
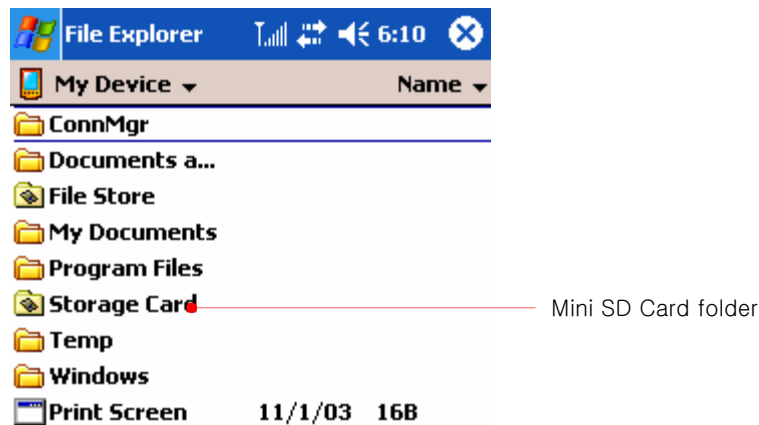

Make or delete a new folder

Select the new folder on the Edit menu of the Command bar.

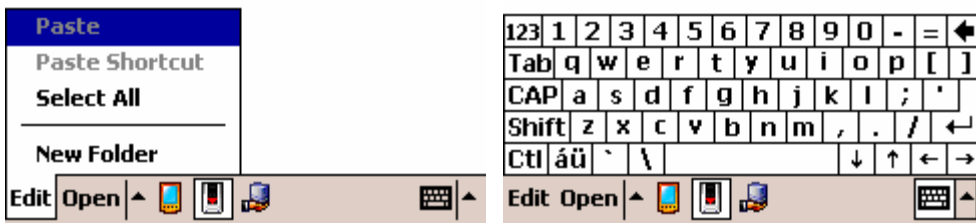
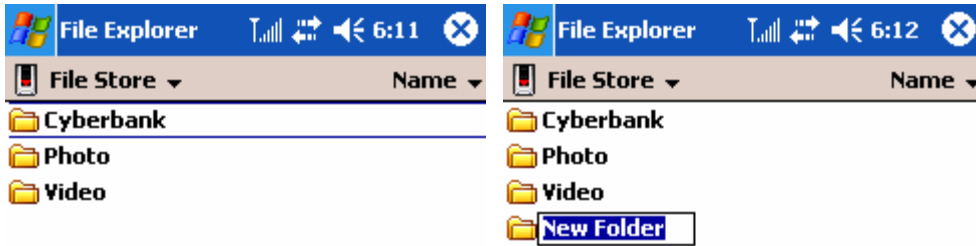

Enter the new folder name.

Select "Delete" on the pop-up menu you tap and hold on this folder to delete this folder.

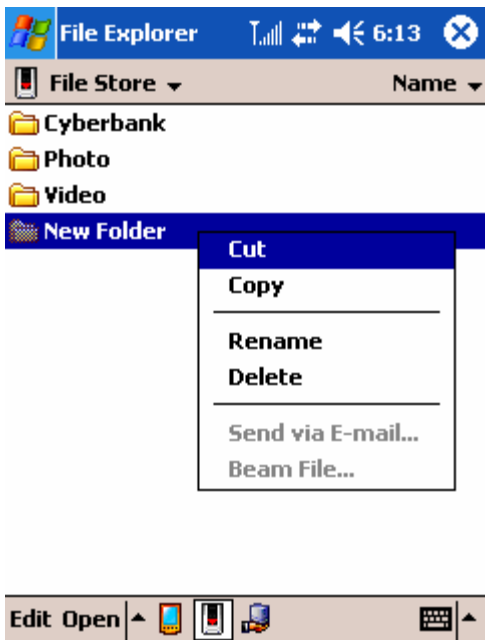

Copy and Paste

Tap and hold the file you cut, copy, rename and delete to have Pop-up menu displayed. Also tap and hold files or folders to have a little different one from a pop-up menu that includes new folder.

Now we show you an example of process where we copy a file from a folder and paste it to another folder.

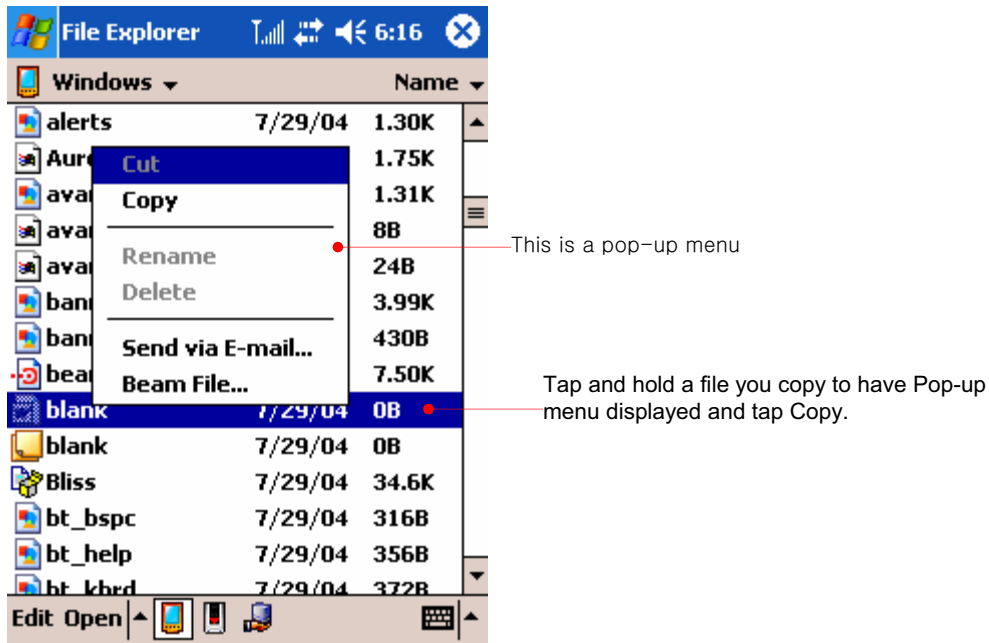

Tap and hold a file you copy to have Pop-up menu displayed and tap Copy. Select My Device you want to paste the copied file to. On the My Device folder, tap and hold the empty space to have pop-up menu that includes Paste.

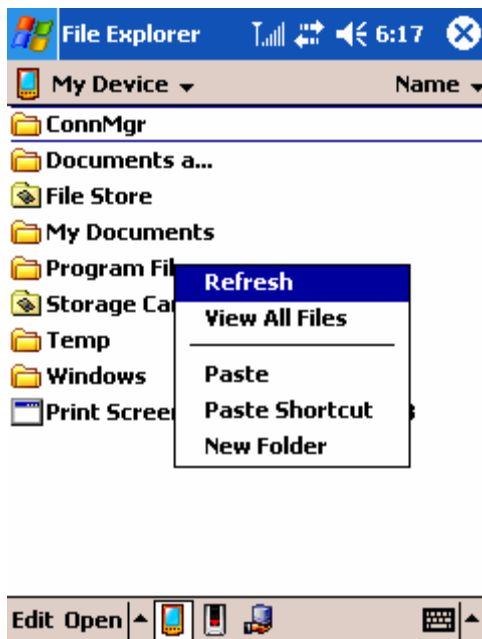

Select "Paste" on the text menu.

Managing Memory

Your device includes three kinds of memory:

- 160 MB of ROM,
- 64MB of storage and program memory (RAM),
- optional SD memory cards.

ROM(32MB OS + 128 MB File Store)

This is a nonvolatile memory; that is, it will not be erased even if your device loses power. In other words, ROM is composed of 32MB memory and 128MB File Store.



The File Store appears under the My Device folder of your device. Files stored in the File Store are not included when you back up your files using ActiveSync or the pocket backup application.



The File Store is non-volatile memory so that it will not be erased after performing hard-resetting. However, when you mistakenly erase the sub-folder of your File Store folder where the some programs are installed from your Companion CD, you have to re-install them from Companion CD.

For more information on backing up your device to the File Store, see “Backing Up and Restoring Data” in chapter 4.

Storage and Program Memory (64MB)

The volatile RAM memory on your device is allocated between storage memory and program memory. The operating system automatically manages the allocation between storage and program memory; however, in some situations—such as when memory is low—it may not be able to adjust the memory properly. Bad sectors amongst the 64 Mb of RAM memory may cause shortages of memory.

If you receive a message stating that storage or program memory is unavailable, try the following solutions.

- To increase storage memory, you can
 - If available, move files or programs into the File Store.
 - Buy an optional mini SD memory card, and move files from internal memory to the card.
 - Remove Web pages stored for viewing offline in Internet Explorer folders.

⦿ **To increase program memory, you can**

- Use Task Manager or the Memory settings to stop programs you are not currently using. In most cases, programs automatically stop to free needed memory. However, in some situations, such as when a dialog box is waiting for a response, the program may not be able to stop automatically.
- Remove your device from the cradle, remove the mini SD card (if inserted), and reset your device.

Mini SD Memory Cards

Mini SD memory cards are small, removable flash storage cards that enable you to expand the memory of your device. You can use mini SD memory cards for backup storage, archives, or to transfer large files to other devices. Mini SD cards can be purchased from a variety of third-party vendors.

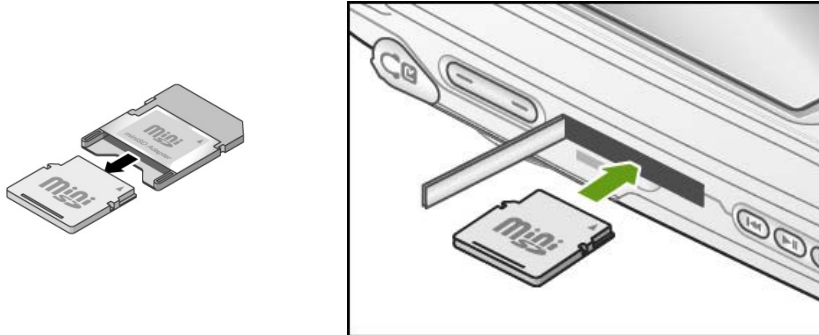

Chapter 3

Using Input Panel

In this chapter you will find followings :

- Using the Input Panel
- Block Recognizer
- Keyboard
- Letter Recognizer
- Transcriber



The information contained in this document is provided “as is” and is subject to change without notice.

Using the Input Panel

Use the Input panel to enter information in any program on your device. You can write using keyboard, Block Recognizer, Letter Recognizer, or Transcriber. In any case, the characters appear as typed text on the screen.

To show or hide the Input panel, tap the Input panel button. Tap the arrow next to the Input Panel button to see your choice.

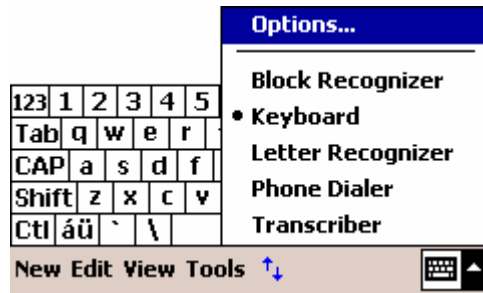

Block Recognizer

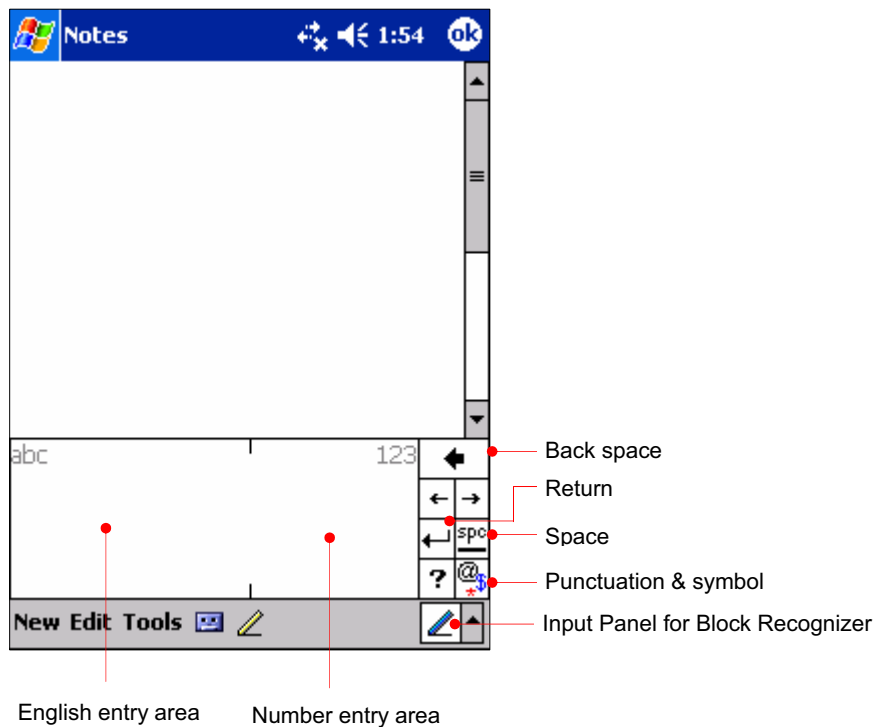

1. Tap the arrow next to the Input panel button, and then tap Block Recognizer.
2. Write a letter in the box.
When you write a letter, it is converted to typed text that appears on the screen. For specific instructions on using Block Recognizer, open Block Recognizer, and then tap the question mark next to the writing area.

Keyboard

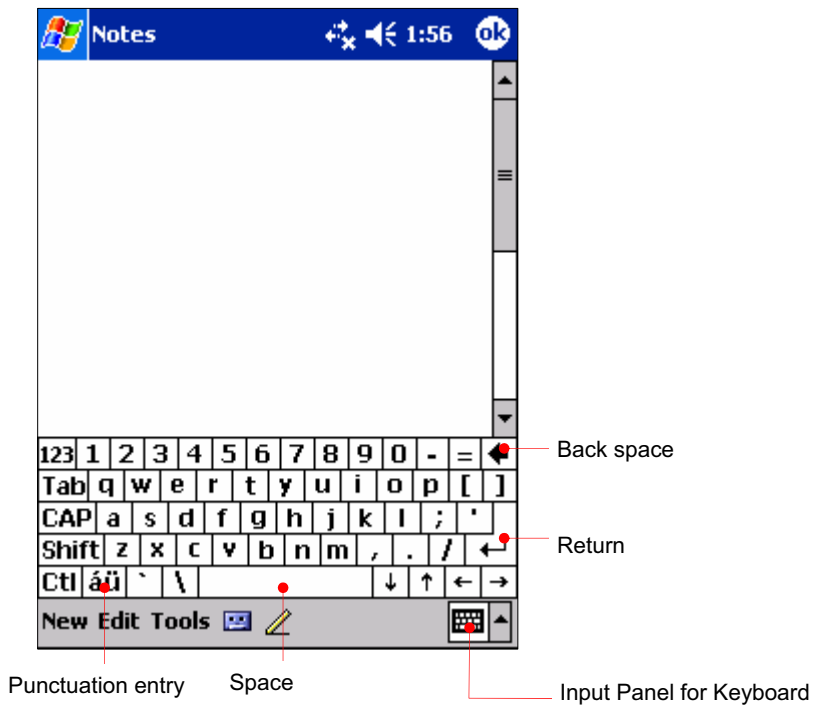

3. Tap the arrow next to the Input panel button, and then tap Keyboard.
4. On the keyboard that is displayed, tap the keys with your stylus.

Letter Recognizer

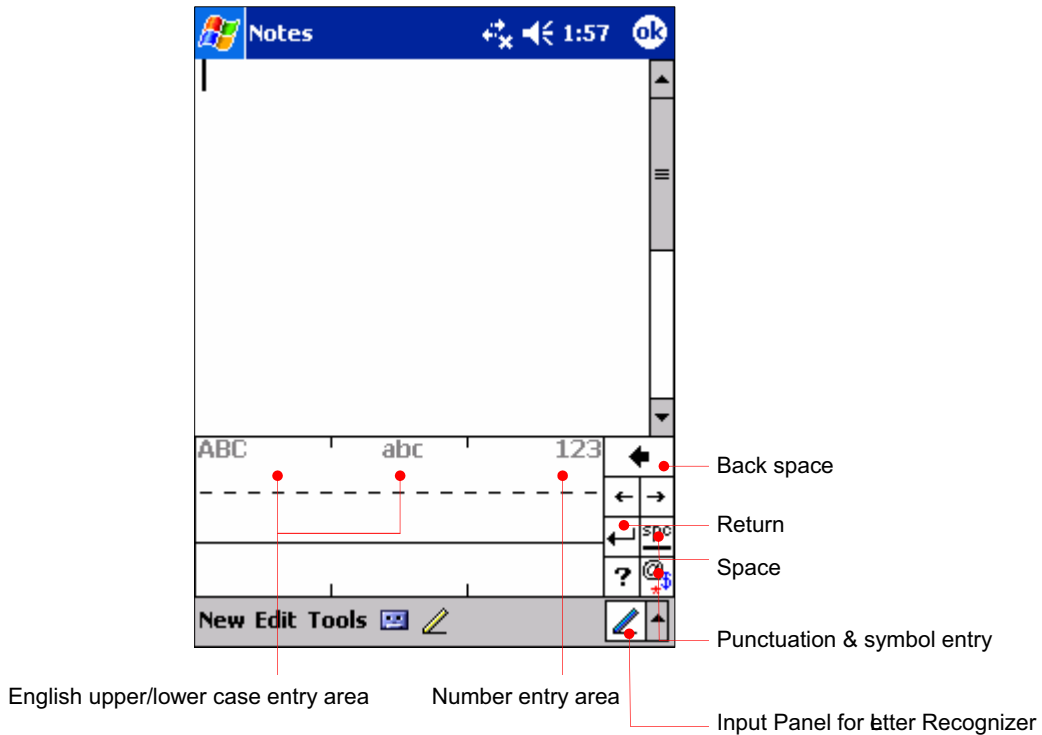

1. Tap the arrow next to the Input panel button, and then tap Letter Recognizer.
2. Write a letter in the box.
When you write a letter, it is converted to typed text that appears on the screen. For specific instructions on Letter Recognizer, open Letter Recognizer and then tap the question mark next to the writing area.

Transcriber

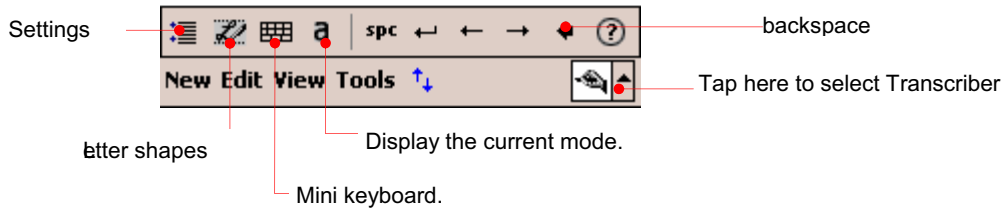

Tap the  button to refer to how to make strokes.

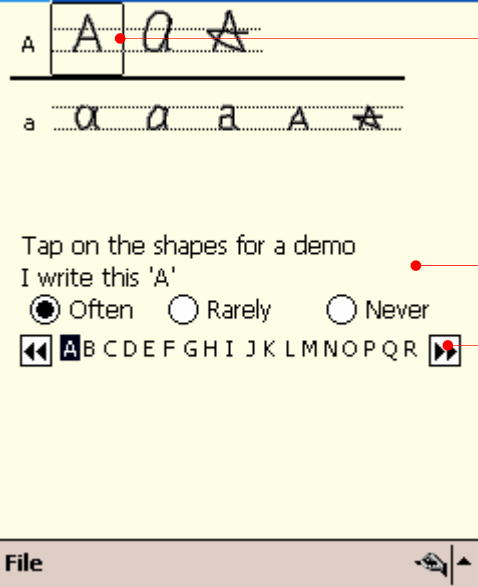

Selected character

Select one of 3 options according to how often you use the selected shape.

Tap these arrows to see more choices.

Tap the punctuation & symbol entry button to have the next window displayed.

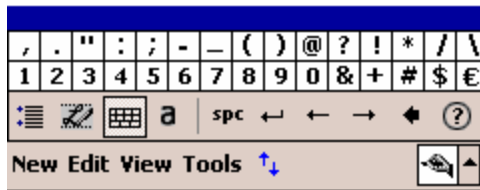

With Transcriber you can write anywhere on the screen using the stylus just as you would on paper. Unlike Letter Recognizer and Block Recognizer, you can write a sentence or more of information; then, you pause and let Transcriber change the written characters to typed characters.

1. Tap the arrow next to the Input panel button, and then tap **Transcriber**.
2. Write anywhere on the screen.
For specific instructions on using Transcriber, open Transcriber and then tap the question mark in the lower-right corner of the screen.

Tap the Settings button to have the next window displayed.

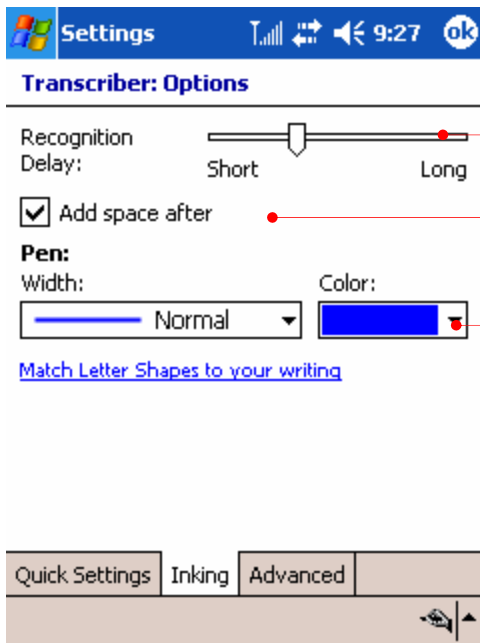
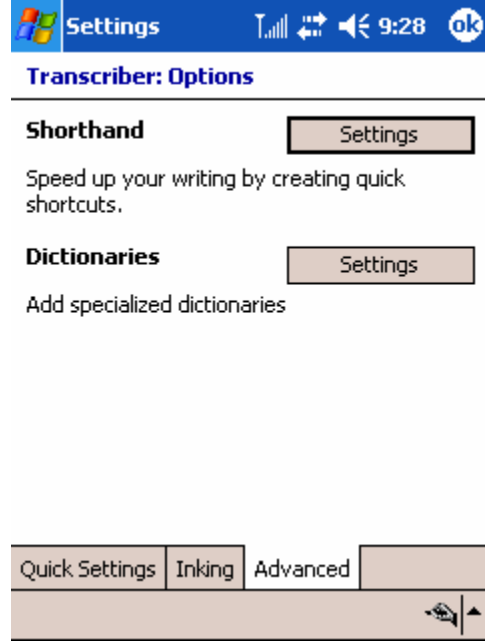
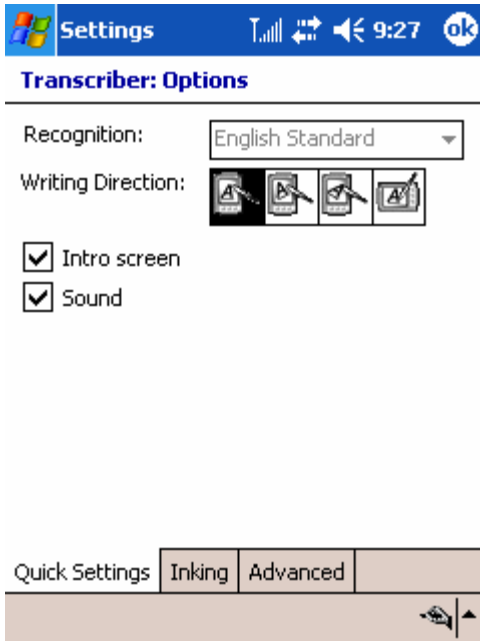

Move the slide to right/left side to select speed and quality.

Add space after entry

Select the width of pen and see sample displayed below

Chapter 4

Connecting to Desktop

To get the most from your device, you will want to connect to your desktop or notebook PC. This chapter describes how to establish the connection between your device and your desktop PC, and how to synchronize and transfer files between your device and your desktop (or any PC that has Microsoft ActiveSync installed).

	Windows Mobile 2002	Windows Mobile 2003
ActiveSync 3.8	○	○
ActiveSync 3.6	○	X
ActiveSync 3.5	○	X

Because Windows Mobile 2003 version is installed on your device, you have to install ActiveSync 3.8 version or later on your desktop PC instead of ActiveSync 3.6 or ActiveSync 3.5.

In this chapter you will find followings :

- Install Microsoft ActiveSync and establish a partnership
- Full Backup & Restore using Backup/Restore of ActiveSync
- How to install programs using ActiveSync



The information contained in this document is provided “as is” and is subject to change without notice.

Install Microsoft ActiveSync and establish a partnership



System Requirements

- Windows 2000 recommended.
- Microsoft Outlook 2002 recommended.
- Office 2000 recommended.
- Microsoft Internet 4.01 SP1 or later recommended.
- 12 ~ 65 MB free hard disk drive
- 9 or 25-pin communication port, IrDA port or USB(Universal Serial Bus) port
- CD-ROM drive
- VGA graphic card or 256 color video graphic adapter
- Keyboard & Mouse

You can download ActiveSync 3.8 or later from followings :

- Companion CD
- Cyberbank web site www.cb.co.kr
- Microsoft web site www.microsoft.com/downloads/

ActiveSync 3.8 file is named as Setup.exe on companion CD, and ActiveSync 3.8 file is named as MSASYNC.EXE when it is downloaded from web site.



This is an explanation on how to install ActiveSync 3.8, based on Windows 2000 Professional, so you may have a little bit different screen on the different OS versions from below.

To use your device, cradle your device and connect USB cable and the power cable with your desktop computer physically. Insert the Companion CD into CD-ROM drive of your desktop computer.

From your initial screen of Companion CD, click the Start button > Install Microsoft ActiveSync 3.8.



On desktop computer, if Autorun doesn't work, Microsoft ActiveSync setup can be launched by suing the run command. Click on Start, and then Run. In the text dialog box, enter the path for the setup file. Typically, you would type X: \ Setup.exe, where X is the letter for your CD-ROM drive.

To get the most from your device, you have to connect to your desktop or notebook PC. Microsoft ActiveSync enables you to synchronize the information on your desktop PC with the information on your device. In addition, you can back up data from your device to your desktop PC and

restore this data to your device, and copy files between your device and desktop PC. Before you begin synchronization, install ActiveSync on your desktop PC from the provided Companion CD. ActiveSync is already installed on your device.

After installation is complete, the ActiveSync Setup Wizard helps you connect your device to your desktop PC, establish a partnership so you can synchronize information between your device and your desktop computer, and customize your synchronization settings.

This is an explanation on how to install ActiveSync 3.8, based on Windows 2000 Professional, so you may have a little bit different screen on the different OS versions from below.

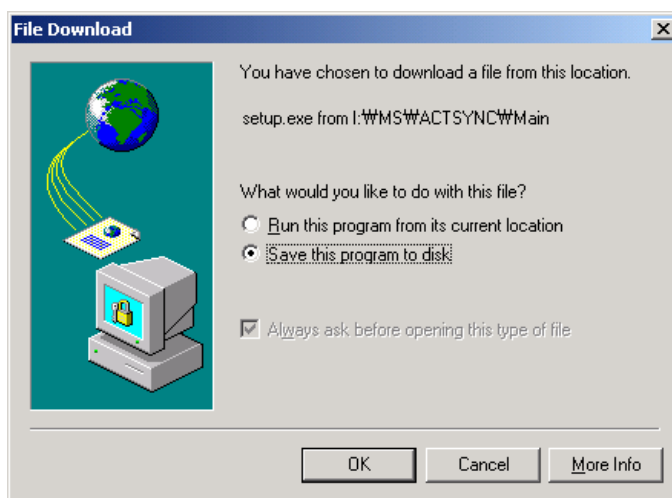

Select Run this program from its current location to install without saving.



Click Yes to move to the next screen.



Click Next.

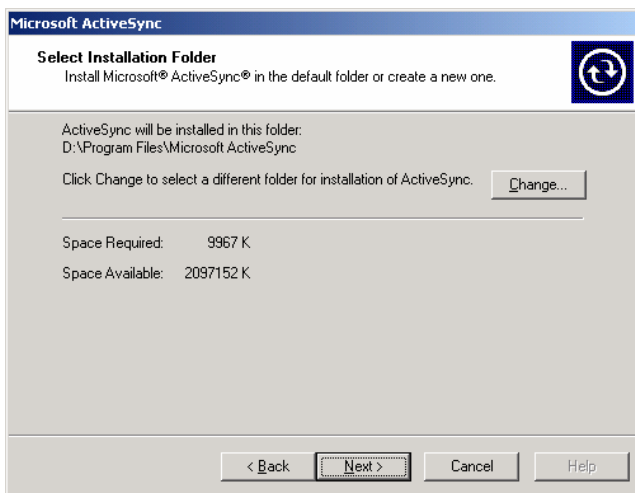

Click Next.

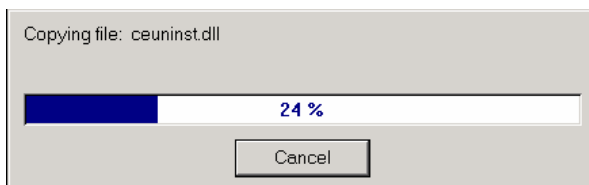

When the process becomes 100%, automatically it will go to the next screen.

Connect USB port to desktop PC and the power cable to cradle. Then seat your device into USB cradle.

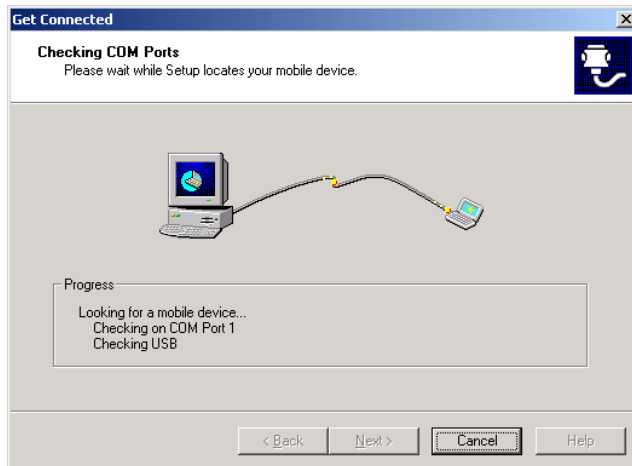

A wizard of finding a new hardware will begin automatically as below.



Click Next.

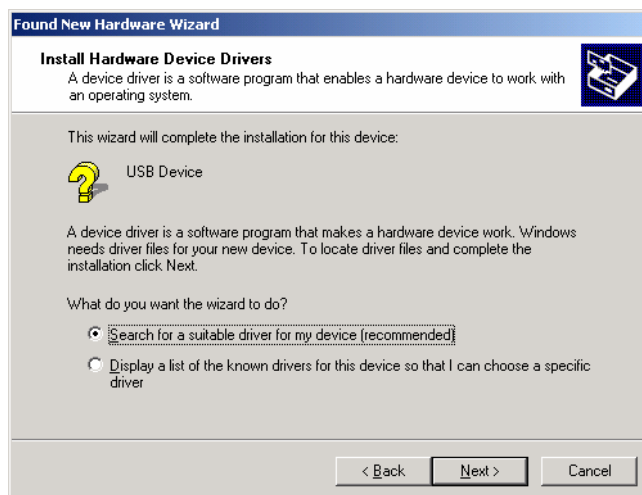

Click Next.

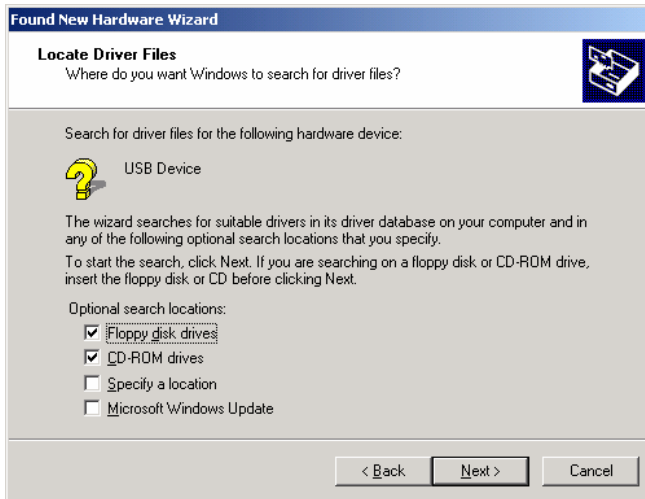

Select CD-ROM drive and click Next.

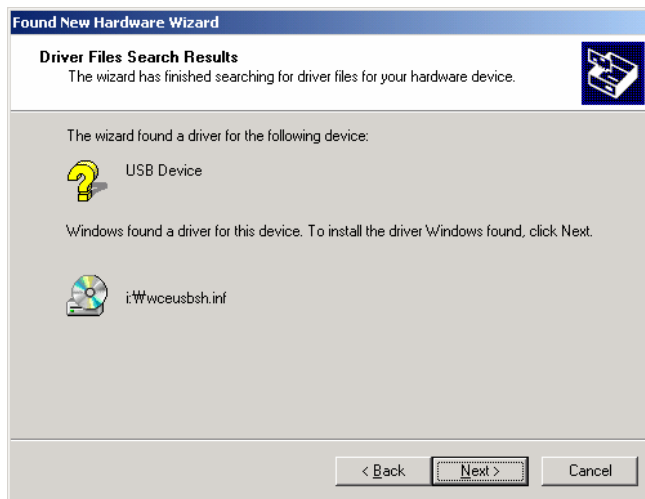

Click Next.



Click Finish and automatically the synchronization process will begin. And then the following processes will appear on your desktop PC.

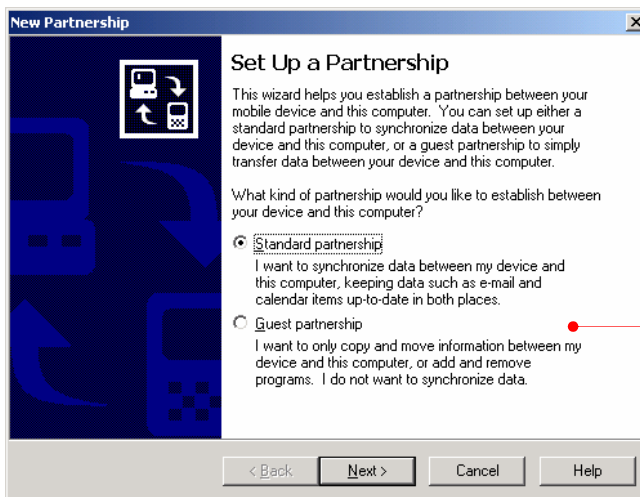

Now you are ready to synchronise between your device and the desktop PC. It may take a while for synchronisation to finish. When set up as a Guest, you can find files by pressing the Explore button on the Toolbar.

Instead of synchronizing, you may set up your device as guest. Even though a guest, you may transfer files and data between your device and your desktop PC.

When you perform hard reset or re-establish a new partnership after deleting the existing partnership, you can select one of the options.

A desktop PC can establish partnerships with several devices while one device can establish partnerships with up to two desktop PCs. However, you cannot synchronize two devices with one desktop PC at the same time.

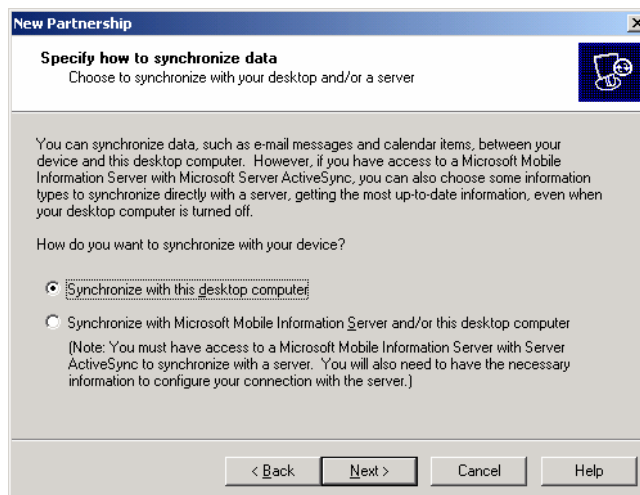

Click Next.

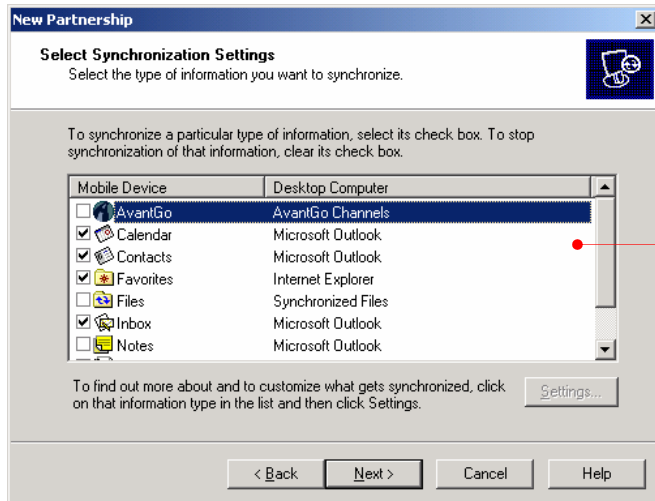

Select any items you want to synchronize and otherwise, deselect the others.

Click Next.

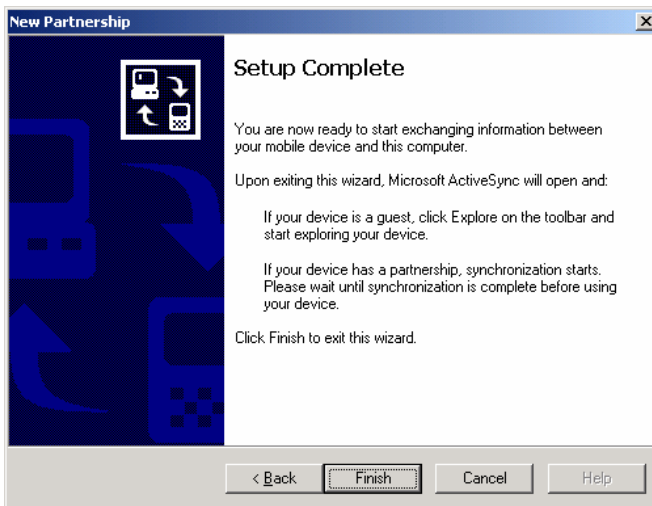

Click Finish. Now, you are ready to establish a new partnership. You will have the Microsoft ActiveSync screen as shown below.

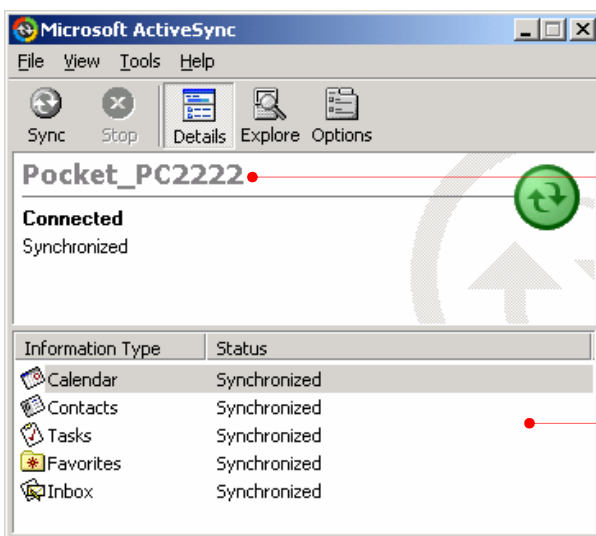

This is the partnership name that is established with your desktop PC through ActiveSync.

These are the items you have selected for synchronizing with desktop PC.

When you perform hard reset on your device, you need to change the

partnership name that is preset as Pocket_PC. (for example : Pocket_PC1, Pocket_PC2, Pocket_PC3, Pocket_PC4)

When you have some difficulties synchronizing your device with your desktop PC, click the Connection Settings on the File menu to have the Connection Settings screen displayed as below.

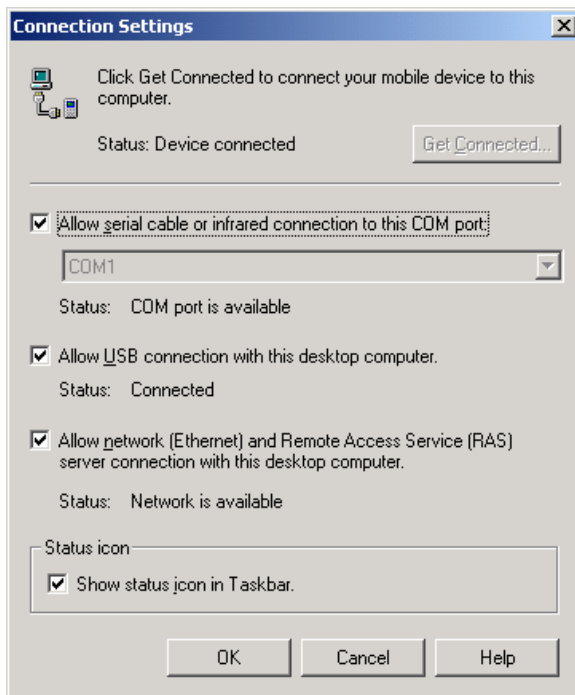

Synchronization compares the data on your device with your desktop PC and updates both computers with the most recent information. For example, you can synchronize Microsoft Word and Microsoft Excel files between your device and desktop PC. Your files are automatically converted to the correct format. And you can synchronize e-mail messages in Inbox on your device with e-mail messages in Microsoft Outlook on your desktop PC. And you can keep your Pocket Outlook Contacts, Calendar, and Tasks databases up-to-dated by synchronizing your device with Microsoft Outlook data on your desktop PC. Use the ActiveSync options to select which information should be synchronized and to control how much data is synchronized. By default, ActiveSync does not automatically synchronize all types of information.

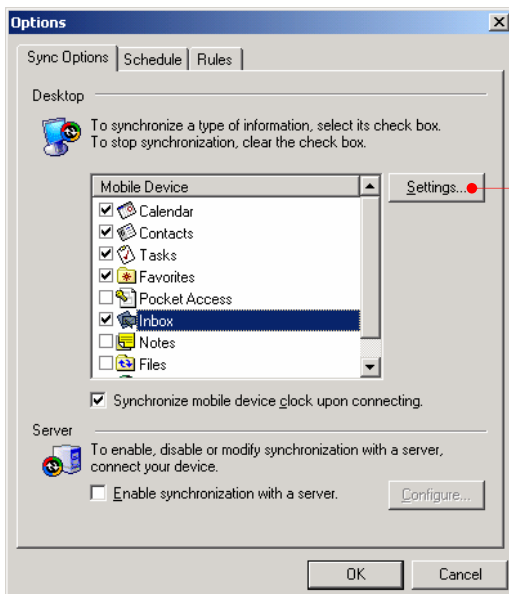

Tap Settings to customize the selected item.

Select Calendar and click the Settings button.

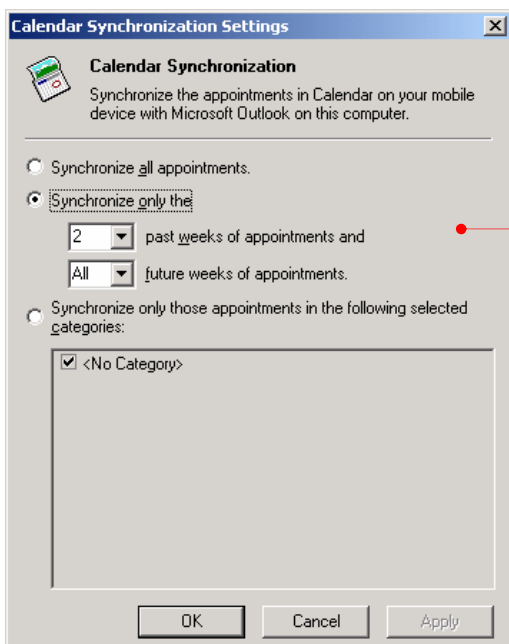

Select any option you want to customize Pocket Calendar during the synchronizations.

Select Contacts and click the Settings button.

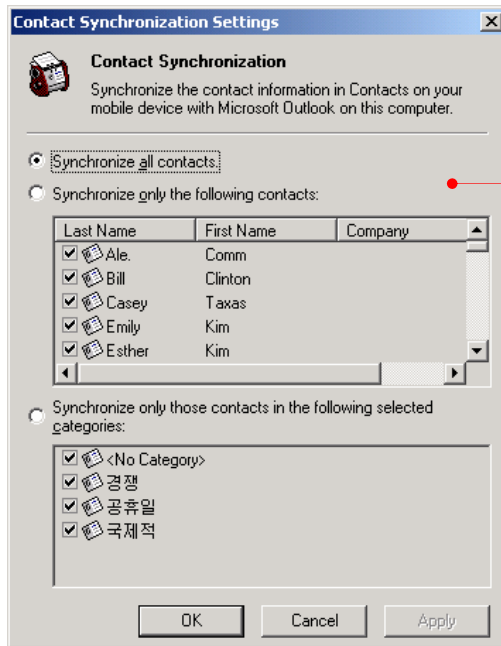

Select any option you want to customize Pocket

Select Tasks and click the Settings button.

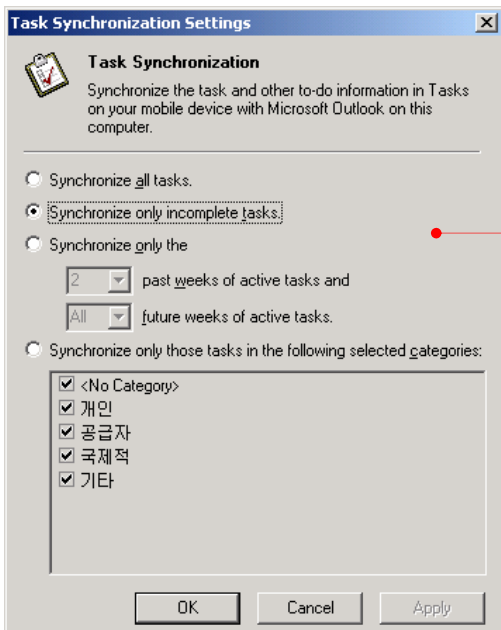

Select any option you want to customize Pocket Tasks

Select Favorites and click the Settings button.

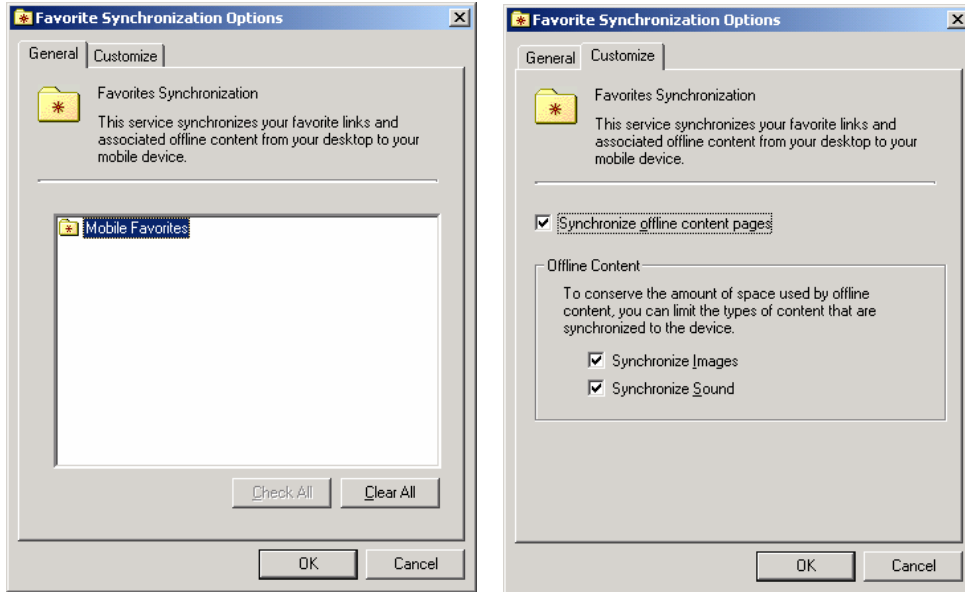

Select Inbox and click the Settings button.

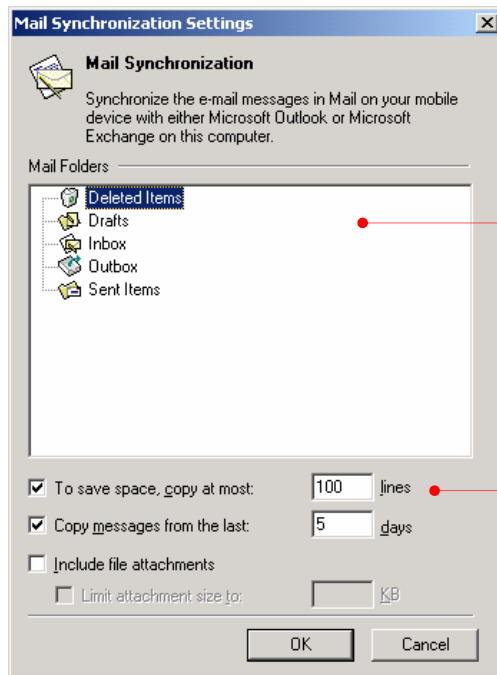

You have to select the folder you have made to

In this example, while synchronizing, it is set as copy at most 100 lines to

Select Files and click the Settings button.

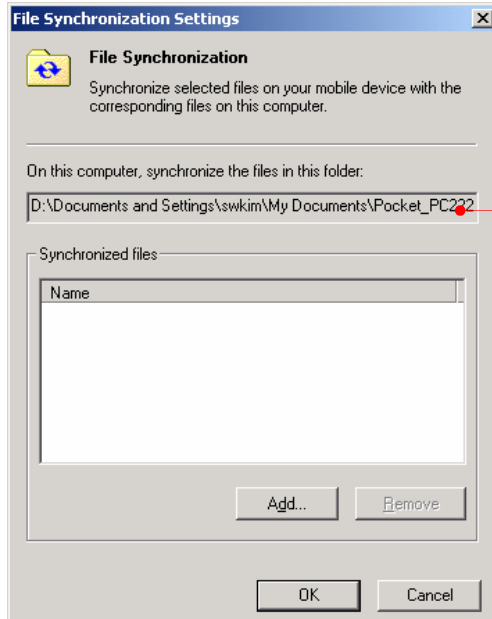

This is the folder that includes the file synchronized with your

After you customized ActiveSync and completed the first synchronization, you can control when synchronization occurs by selecting a synchronization mode.

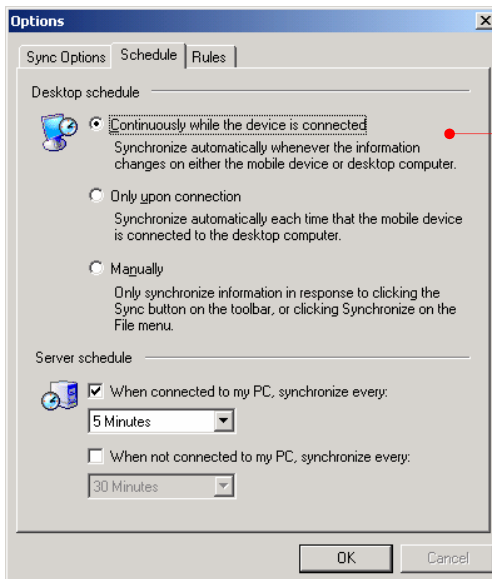

Select one of the 3 options: continuously

Copy, Paste and transfer files

Select the file(s) you want to copy and select Copy on the Edit menu or select Copy on the pop-up menu. For pasting file(s), select the Explore button on the Microsoft ActiveSync screen of your desktop PC to have the Mobile Device screen displayed as below :

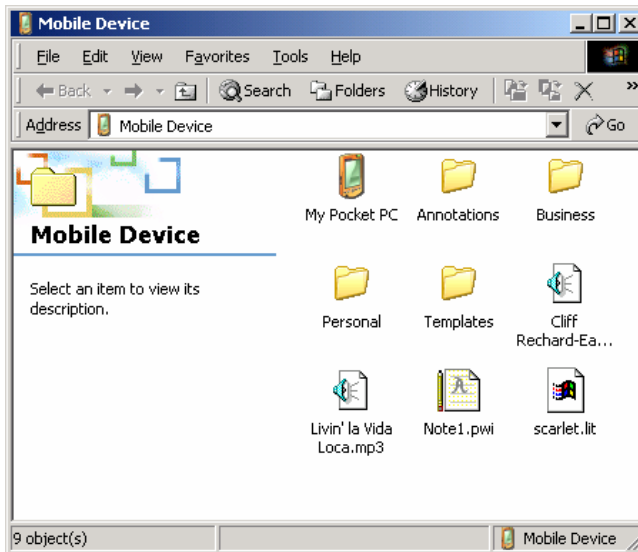

First, select the folder you want to paste and select Paste on the Edit menu or select Paste on the pop-up menu.

However, when you transfer file(s) between desktop PC and your device, files created on your desktop PC may automatically need to be converted before you can use them on your device, and also files created on your device may automatically need to be converted before you can use them on your desktop PC. However, when you work with software such as ClearVue Presentations or ClearVue Image, files should not be converted to the different format. In other words, those software use the format identical to the corresponding software of your desktop PC. That's why we need to change the settings of converting file format when files don't need to be converted before you can use them on your device.

You can change the settings as follows :

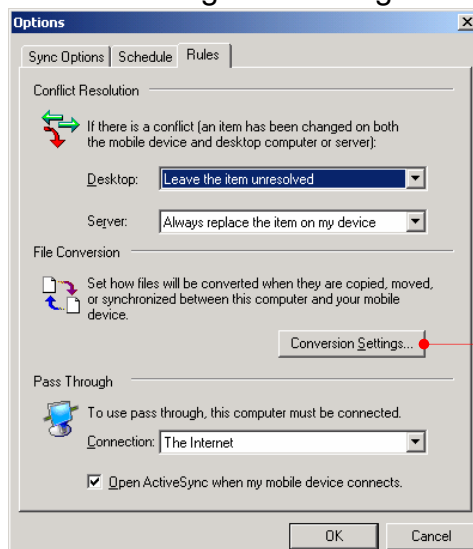

Tap the Conversion Settings to change the options for conversion

Select Conversion Settings.

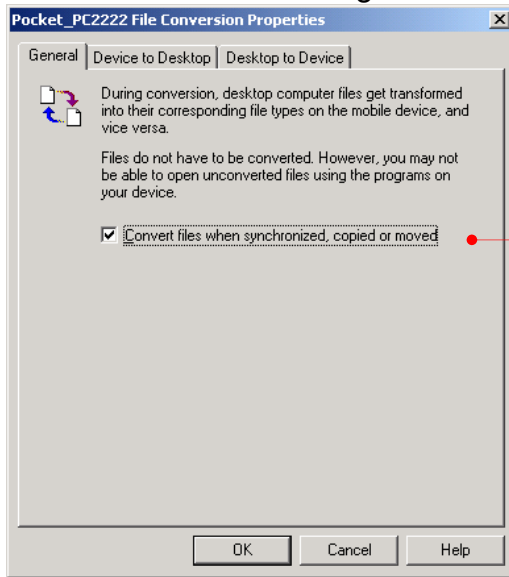

Deselect this option box
not to change the file

Full Backup & Restore using Backup/Restore of ActiveSync

You can back up files, database, PIM data and programs installed in RAM to your desktop PC using Microsoft ActiveSync, and restore them when needed.

Backup can either be performed automatically when your device is connected to your desktop PC, or manually whenever needed. Also, you can back up updated or new data only or choose to back up all data.



Automatic backup is only possible when a Partnership is established with a desktop PC. Only a manual backup is possible when the partnership is established as Guest. For more information on Backup/Restoring to and from a desktop PC, see Microsoft ActiveSync Help.

Backup

1. Connect your device to desktop PC.
2. Tap **Backup/Restore** on the **Tools** menu of the ActiveSync screen.

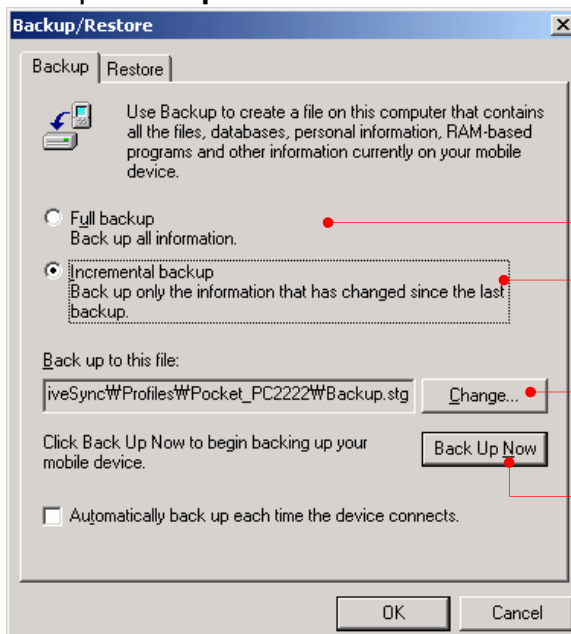

Full backup

Incremental backup.

Tap Change to change backup name.

Tap Back Up Now to begin.

3. Select “Full backup” or “Incremental backup” according to your needs.
4. You may need the backup file name and the folder when restoring your backup file. Tap the Change button to confirm the folder.
5. Tap the Back Up Now button to begin.

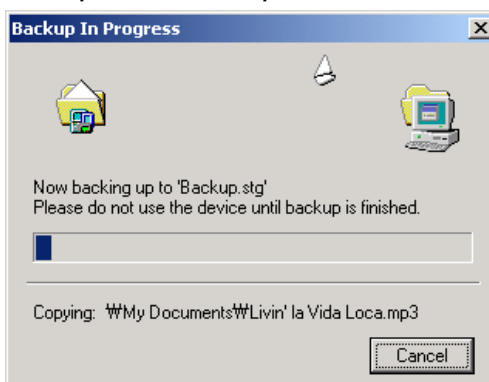



Do not remove your device from the cradle or disconnect the USB cable during backup.

Restore



As newly installed programs or new files created on your device since your last backup will be lost after restore, you should move them to your desktop PC or to File Store (NAND Flash memory) before you restore data.

1. Connect your device to desktop PC.
2. Close all programs running on your device.
3. Establish a partnership as Guest.

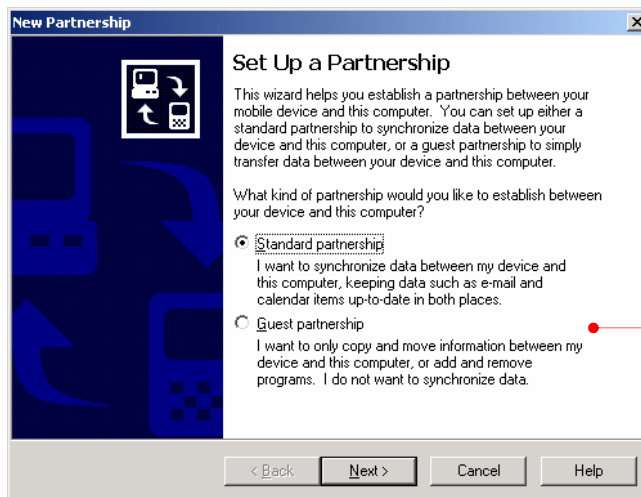

Select this options box to set up your device as guest.

4. Tap **Backup/Restore** on the **Tools** menu of the ActiveSync screen, and select the **Restore** tab.



5. Tap the Restore Now button.

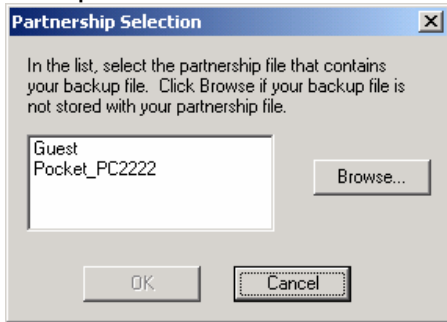

6. Select the backup file you want to restore and select OK to begin.

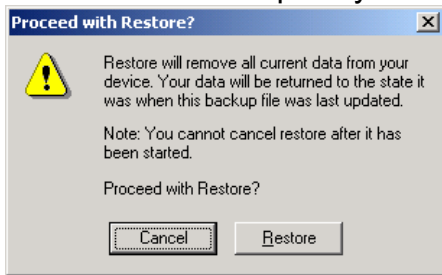

7. Click Restore to begin the restore process.

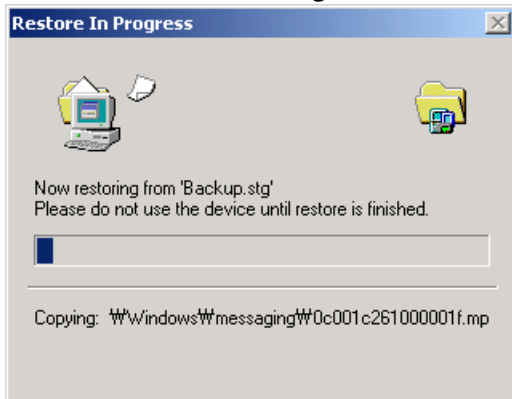

8. When completed, perform **soft Reset** on your device with your stylus and seat your device on your cradle to synchronize.



Do not use your device until Restore is completed.

How to install programs using ActiveSync

Using Setup.exe or Install.exe

1. Download the program to your desktop computer (or insert the CD or disk that contains the program into your desktop computer).
2. Connect your device to your desktop PC.
3. If the program includes an installer program (typically named Setup.exe or Install.exe), double-click the installer program on the desktop PC. The installer program copies the necessary files to your device.

Using cabinet (*.cab) file

1. Download the program to your desktop computer (or insert the CD or disk that contains the program into your desktop computer).
2. Connect your device to your desktop PC.
3. Use the ActiveSync Explore button to copy the cabinet (*.cab) file to the Program Files folder on your device, and then double-tap the icon on your device to install the program.
4. Refer to the Read Me file or documentation that came with the program to be sure you have copied the necessary file(s). For more information on copying files using ActiveSync, see ActiveSync Help.

Chapter 5

Configuring Device

This chapter details ways you can optimize your device using the Settings, and describes ways you can expand features and functionality by adding programs. This chapter also offers important tips on safeguarding your data by managing power and memory.

In this chapter you will find followings :

- Settings



The information contained in this document is provided “as is” and is subject to change without notice.

Settings

On the Start menu, tap Settings. You will see 3 tabs: Personal, System and Connections.

1. the Personal tab

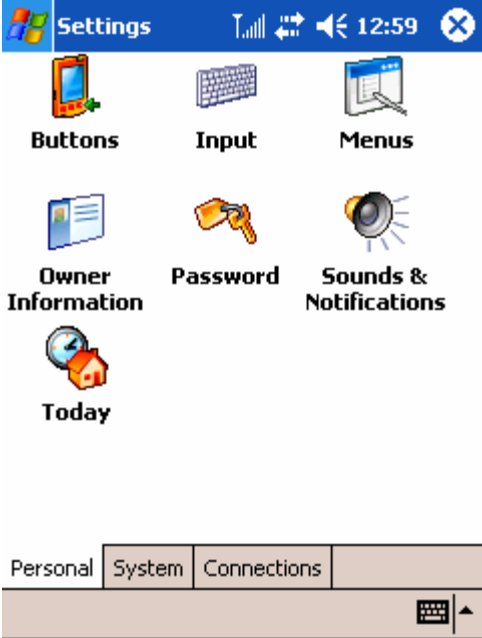

Tap the Buttons (📱) icon to assign functions to the 4 buttons located on the front of your device. You can assign some functions to the hardware buttons using this setting.

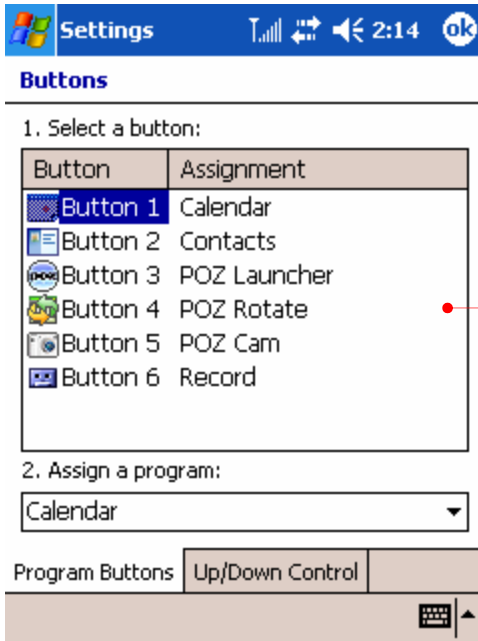

First, select a button among the 4 buttons and select a program you want for that button on the assignment.

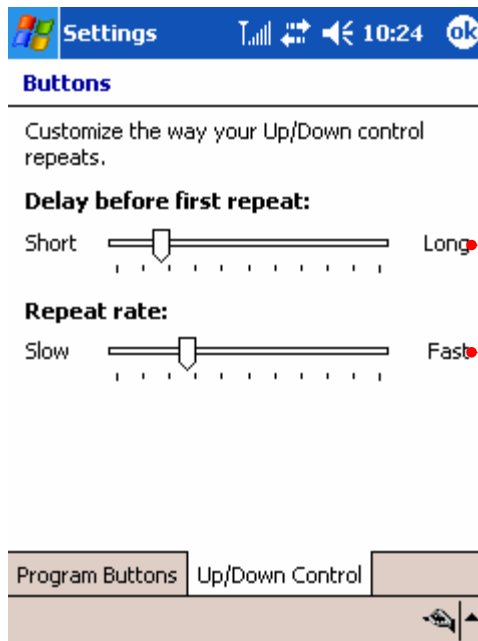

Move the slide to adjust the delay before first repeat.

Move the slide to adjust the repeat rate.

Tap the Input (🖱️) icon to adjust a setting on the Input Panel.

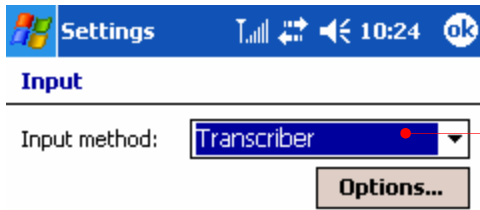

Select the default mode among Block Recognizer, keyboard, letter Recognizer, Phone Dialer and Transcriber.

With Transcriber you can write in cursive, print or mixed handwriting on the screen and your ink is instantly recognized.

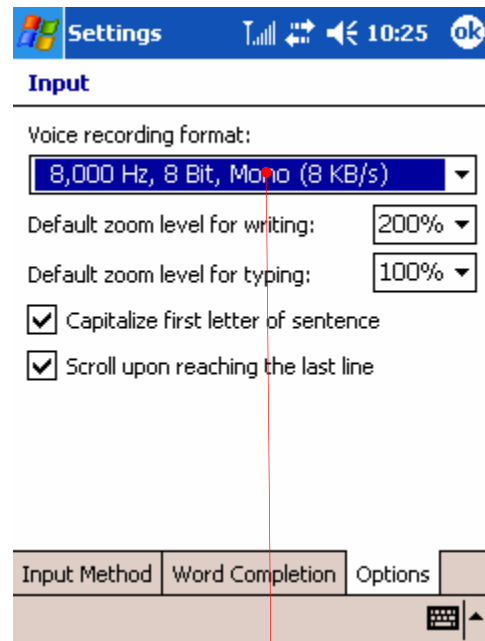
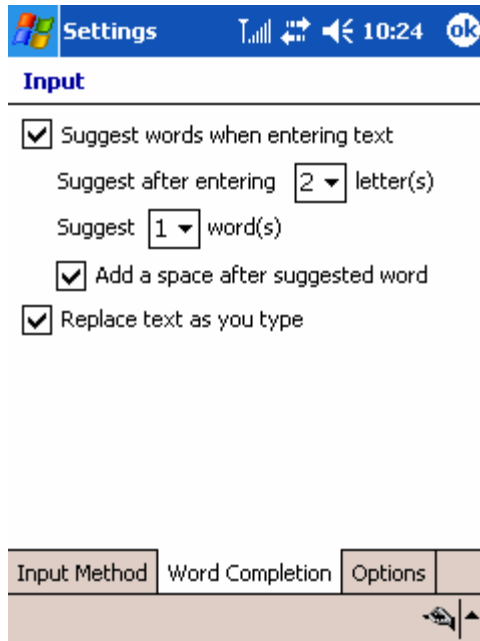
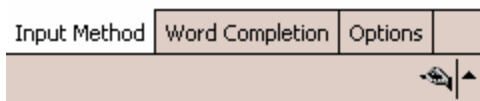

It is recommended that you select the default mode of voice recording format to conserve your memory size.

Tap the Menu (☰) icon to adjust the programs listed on the Start menu and New menu.



Selected items appear in the Start menu. Otherwise, the rest appear in Programs.

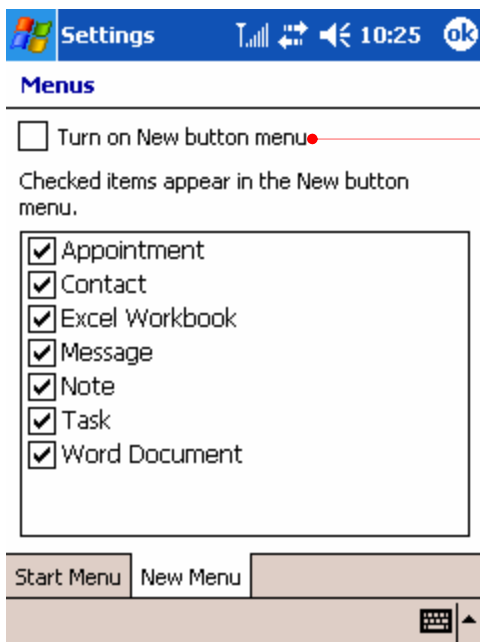

Select the Turn on New button menu item to have the selected items displayed on the New menu list.

Tap the Owner Information (📄) icon to enter your personal information.

The screenshot shows the 'Owner Information' settings screen. At the top, there is a blue header with the 'Settings' logo, signal strength, Wi-Fi, and battery icons, and the time '10:25'. Below the header, the title 'Owner Information' is displayed. The main area contains several input fields: 'Name:', 'Company:', 'Address:', 'Telephone:', and 'E-mail:'. To the right of these fields is a larger 'Notes:' field. At the bottom of the screen, there is a keyboard overlay with a numeric keypad, a QWERTY keyboard, and function keys like 'Tab', 'CAP', 'Shift', and 'Ctl'. A small keyboard icon and an arrow are visible in the bottom right corner of the screen.

This screenshot shows the 'Owner Information' settings screen with the 'When the device is turned on, display:' section. The header and title are the same as in the previous screenshot. Below the title, the text 'When the device is turned on, display:' is followed by two checkboxes: 'Identification information' and 'Notes'. Both checkboxes are currently unchecked. The keyboard overlay is not visible in this screenshot.

Select this option box to show this information when device is turned on.

This screenshot shows the 'Owner Information' settings screen with the 'When the device is turned on, display:' section. The header and title are the same as in the previous screenshot. Below the title, the text 'When the device is turned on, display:' is followed by two checkboxes: 'Identification information' and 'Notes'. Both checkboxes are currently unchecked. The keyboard overlay is not visible in this screenshot.

Tap the Password (🔑) icon to change a password.

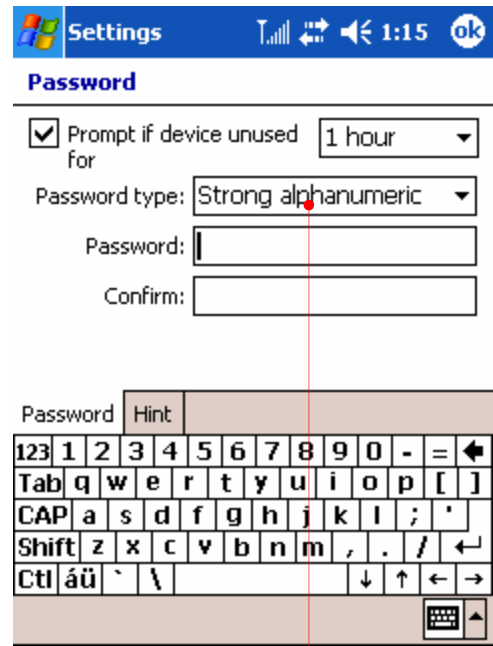
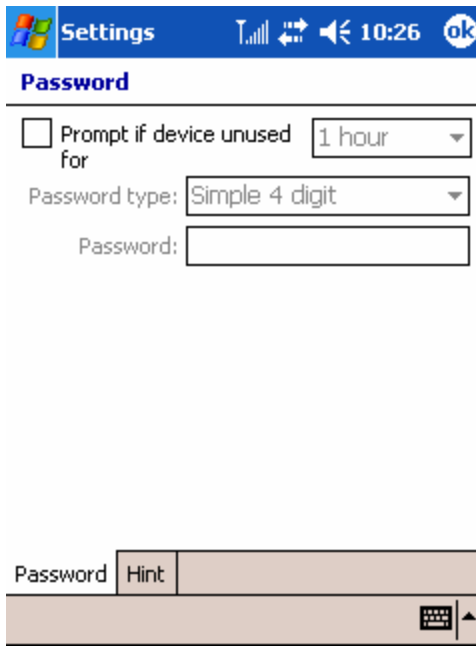

When you select the Strong alphanumeric password item, you have to enter the digit password: a combination of the English upper case and lower case letters.



Tap the Sounds & Notifications (🔊) icon to adjust sounds that is enabled for events, programs, screen taps and hardware buttons.

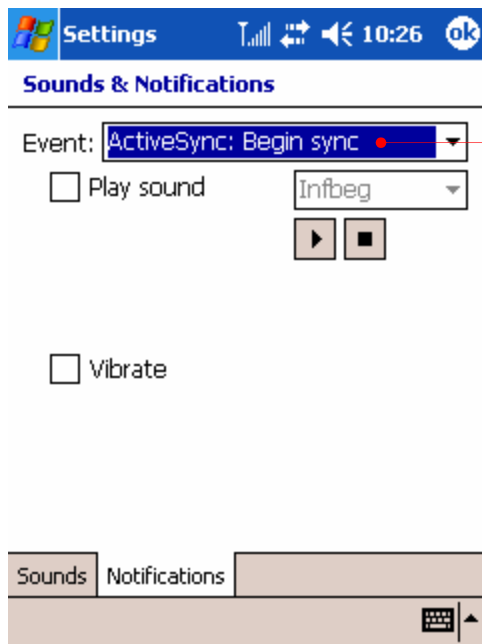
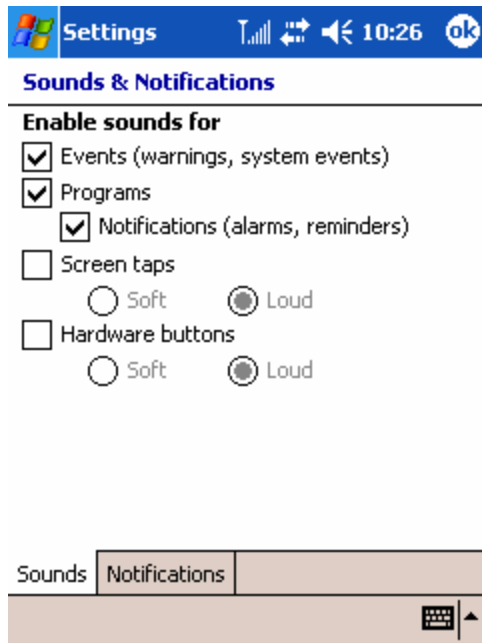

According to each event, select the corresponding sounds or notifications.

Tap the Today (📅) icon to use an image file as the background and select programs that appear on the Today screen.

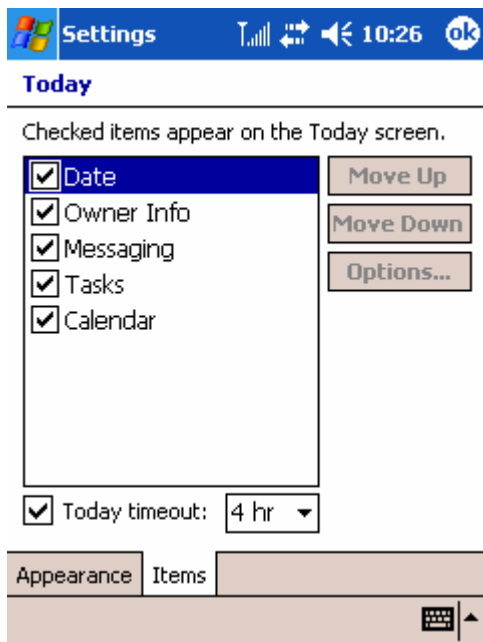
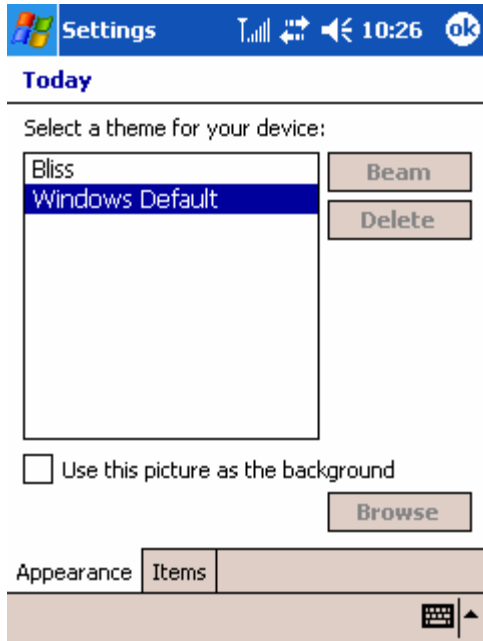

2. the System tab

Tap the About () icon to see the version and copyright.

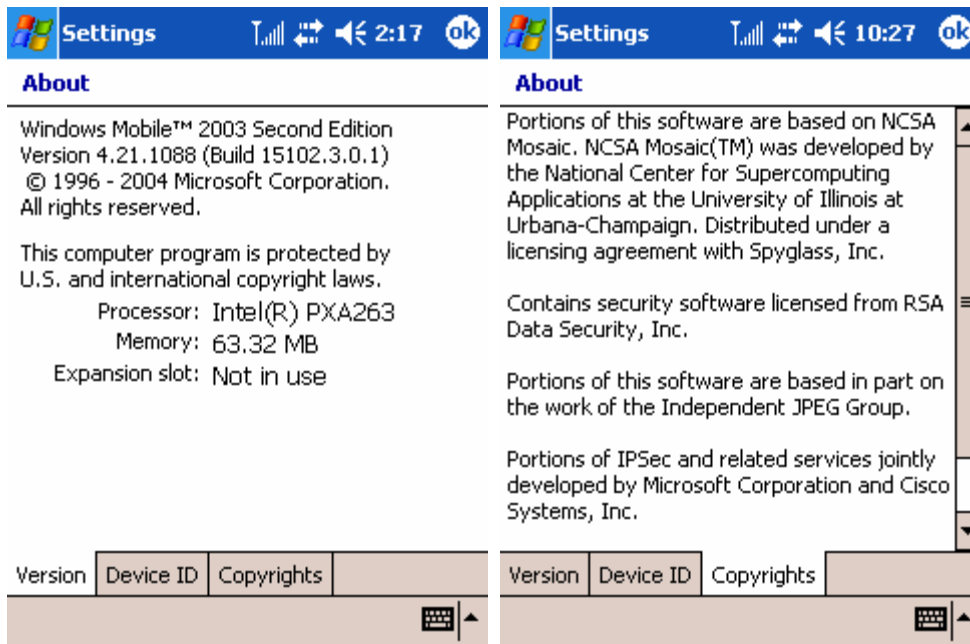

Your device uses this information to identify itself to other computers. Enter a name that starts with a letter and contains the characters _ , A-Z, or 0-9.

Device name:

Description:

While synchronized, this will be used for identifying itself and establishing a partnership.



Tap the Backlight () icon to adjust the backlight.



Backlight

Warning: Using backlight while on battery power will substantially reduce batter life.



On battery power

- Turn off backlight, if device is not used for 30 sec
- Turn on backlight, when a button is pressed or the screen is tapped

It is recommended to conserve your battery life that you turn off backlight if device is not used for the time you select here.

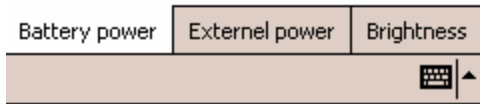

BackLight



On external power

- Turn off backlight, if device is not used for 10 m
- Turn on backlight, when a button is pressed or the screen is tapped



BackLight



Brightness

Dark Light

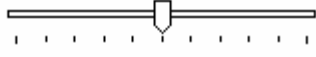
Battery 

Dark Light

External 



Tap the Clock (🕒) icon to adjust the current time and alarms.

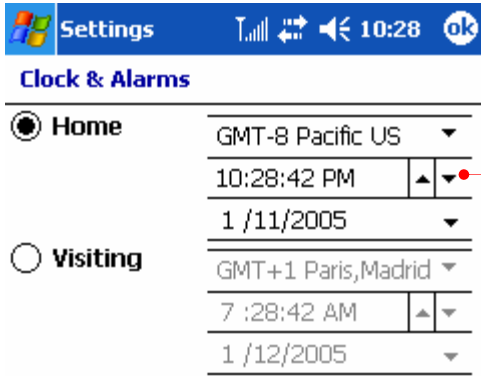

Select the right one according to where you stay.

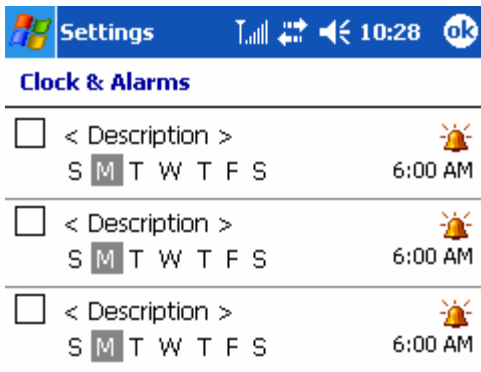
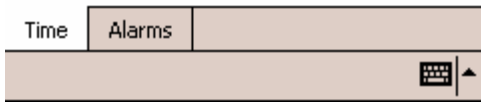

Tap the Memory (🧠) icon to adjust the allocation of memory temporarily.

Memory

Total main memory: 63.32 MB

Storage **Program**

Allocated: 31.66 MB Allocated: 31.66 MB

In use: 1.19 MB In use: 14.89 MB

Free: 30.47 MB **Free:** 16.77 MB

Memory

Total storage card memory: 120.50 MB

In use: 31.22 MB Free: 89.28 MB

File Store

Main | Storage Card | Running Programs | ▶

[Find](#) large files using storage memory.

Main | Storage Card | Running Programs | ▶

[Find](#) large files using storage memory.

Memory

Running Program List:

ActiveSync

Activate Stop Stop All

Main | Storage Card | Running Programs | ▶

[Find](#) large files using storage memory.

To conserve the program memory, you can stop programs that are not being used.

Tap the Power (🔋) icon to see the state of battery.



Power

Main battery LiPolymer
Charging

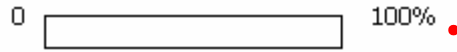

While being seated on cradle, if main battery is not fully charged, it will move from 0 to 10% on the charging bar

Backup battery LiPolymer
Recharging state:



Display the state of backup battery.

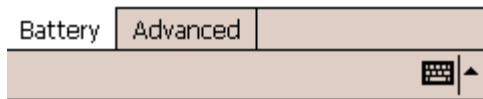

Advanced

On battery power:

Turn off device if not used for 3 min

On external power:

Turn off device if not used for 5 min



Tap the Regional Settings (🌐) icon to adjust the time, number, especially period, money and data type.



Regional Settings

English (United States) ▾

Select where you stay.

Appearance samples

Positive numbers: 123,456,789.00
 Positive currency: \$123,456,789.00
 Time: 10:30:04 PM
 Short date: 1/11/05
 Long date: Tuesday, January 11, 2005



Regional Settings

Time sample: 10:30:35 PM

Time style: h:mm:ss tt ▾

Time separator: : ▾

AM symbol: AM ▾

PM symbol: PM ▾



Regional Settings

Short date: 1/11/05
 Long date: Tuesday, January 11, 2005

Short date: M/d/yy ▾

Date separator: / ▾

Long date: dddd, MMMM dd, yyyy ▾

Calendar type: Gregorian Calendar ▾

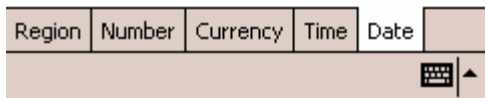
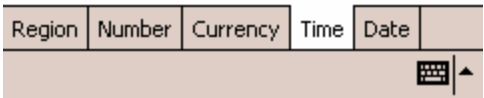

Tap the Remove Programs () icon to remove the programs that are installed on your device.

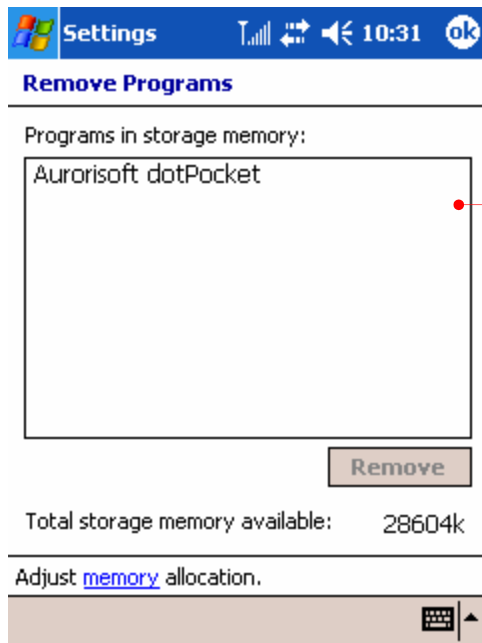

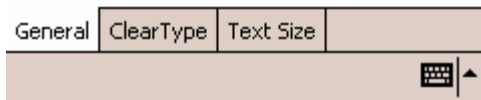
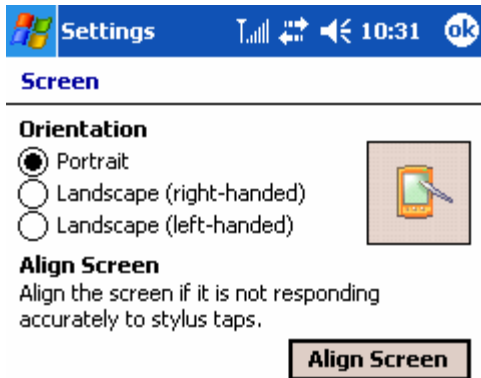

When the storage memory is short, remove the program installed on your device.

Tap the Screen (📱) icon to adjust the touch screen if your device is not responding accurately to screen taps.

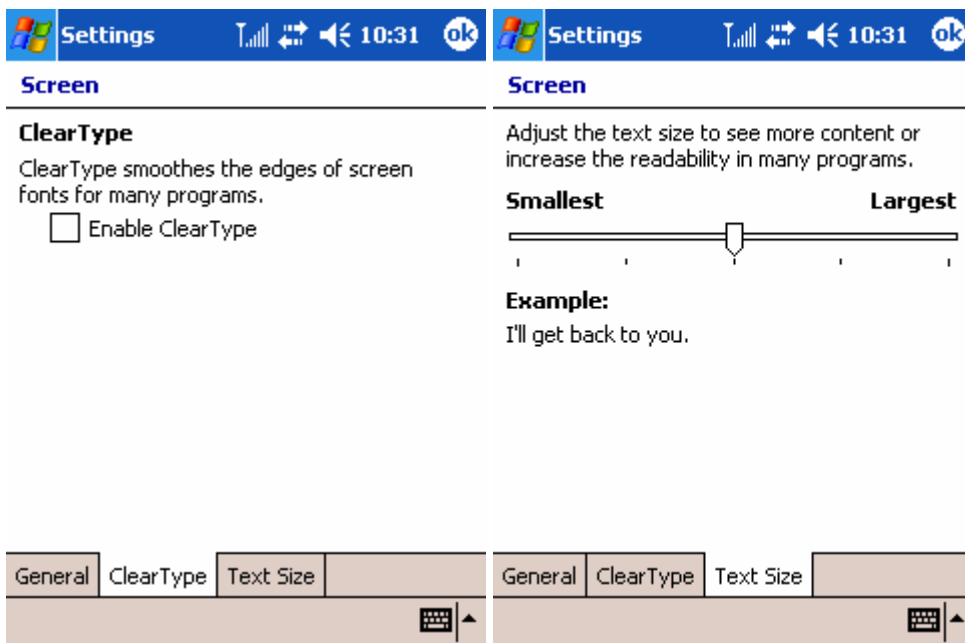

Press down the up button of the up/down control and press the power button at the same time to have the Align Screen displayed.



Tap the Sound() icon to adjust the sound effectively.

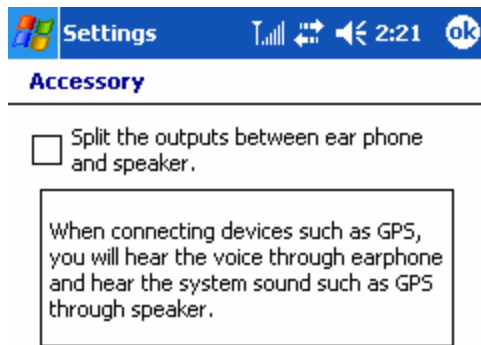
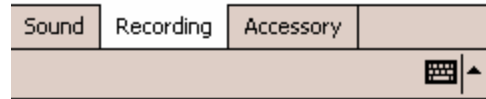
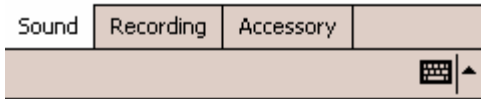
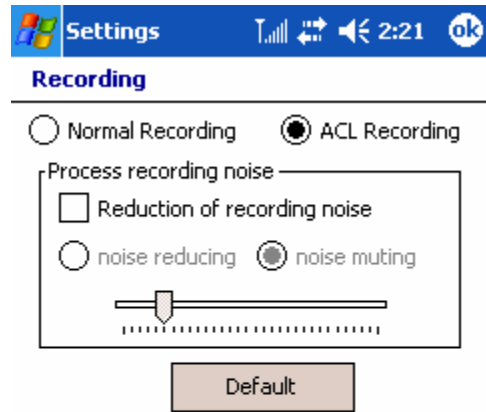
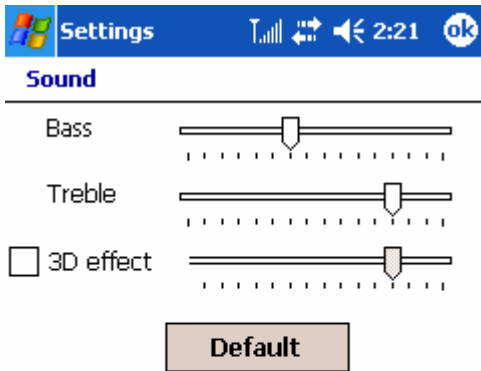

Tap the System() icon to see system information.

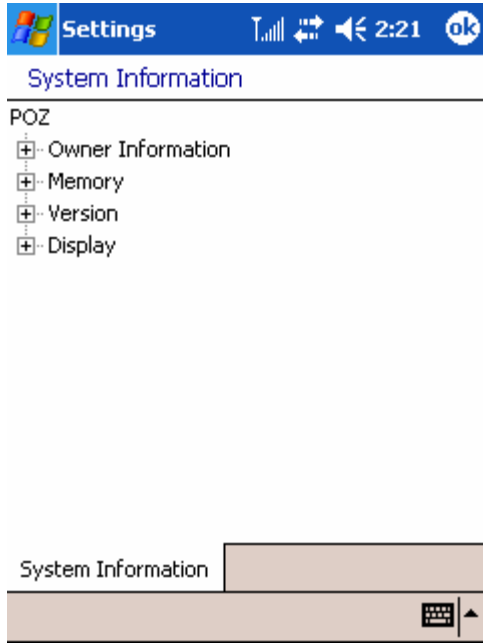

3. the Connections tab

Tap the Beam () icon to adjust the beam settings of your device.

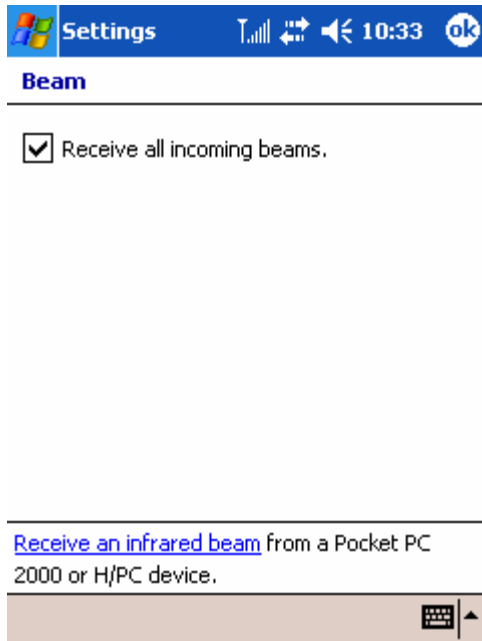

Tap the Connections (📶) icon to set the options for a modem connection.

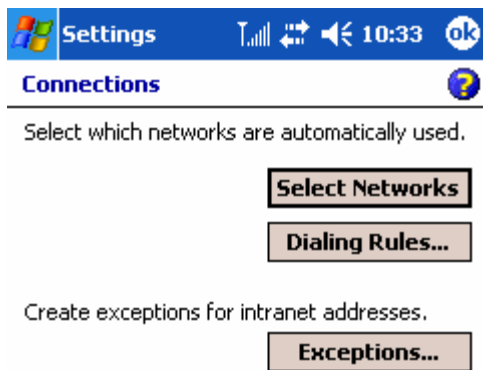
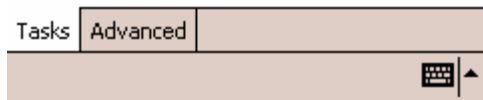
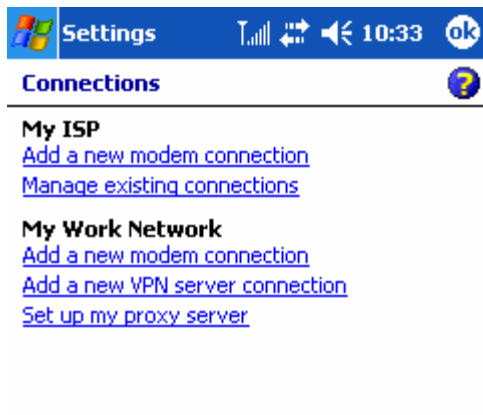

Tap the Network Cards (📶) icon to change the settings for network adapters.

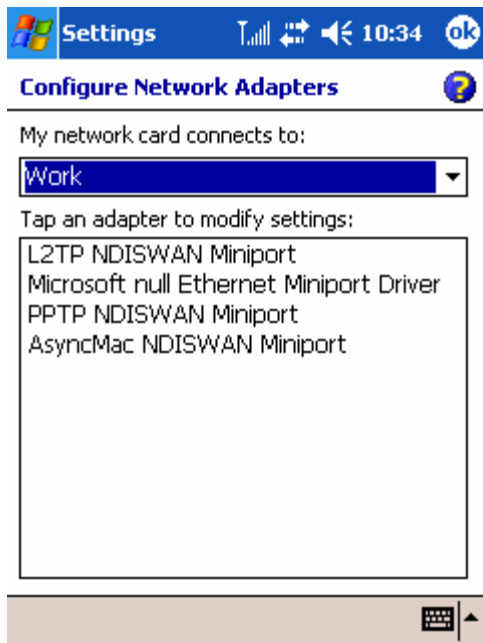

Chapter 6

Using the Internet & Messaging

In addition to connecting your device to your desktop PC, you may want to connect to remote computers so you can access messaging, browse the Internet, or retrieve files from a corporate network, whether you are at home or on the road.

☉ To start the connection, simply open a program that requires a connection to the Internet. Your device will attempt to connect automatically.

- Visit Internet or intranet Web or WAP pages using Pocket Internet Explorer.
- Send and receive e-mail messages using Messaging. Before you can use Messaging, you need to provide the information it needs to communicate with the e-mail server.
- Send and receive instant messages with MSN Messenger. For more information, see “MSN Messenger” in chapter 9.

In this chapter you will find followings :

- browsing the Web on your device
- sending and receiving E-Mail Messages
- Connecting directly to E-Mail server



The information contained in this document is provided “as is” and is subject to change without notice.

Browsing the Web on your device

Once you are connected to an ISP or to a network, you can browse the Internet or a corporate intranet. You can also use Pocket Internet Explorer to browse Web and WAP content while you are not connected—by downloading mobile favorites and channels to your device.

Using Microsoft Pocket Internet Explorer

Use Microsoft Pocket Internet Explorer to view Web pages in either of these ways:

- Connect to an ISP or network and browse the Web. To do this, you will need to create the connection first.
- During synchronization with your desktop PC, download mobile favorites that are stored in the Mobile Favorites subfolder in Internet Explorer on the desktop PC.

While you are connected to an ISP or network, you can also download files and programs from the Internet or an intranet.

To start Pocket Internet Explorer

1. On the Start menu, tap Internet Explorer.



Refresh button Home button Mobile Favorites button

2. On the View menu, tap Address Bar.
3. Enter address you want on the address bar located on the top of

screen and tap the arrow next to the address bar, then it will automatically connect to the Internet using CDMA module.

4. When the internet connection is completed, the internet connecting () icon will appear on the Navigation bar.

5. Tap the stop () button on the Command bar and also you need to tap X on the right-upper corner to stop your Internet connection completely.

Mobile Favorites folder

Only items stored in the Mobile Favorites subfolder in the Favorites folder in Internet Explorer on your desktop PC will be synchronized with your device. This folder is created automatically when you install ActiveSync.

You can only view the mobile favorites offline that was synchronized with your desktop PC. If the page is not synchronized with your desktop PC, it will be dimmed in the Favorites list of your device. You will need to synchronize with your desktop PC again to download the page to your device, or connect to the Internet to view the page.

To make Mobile Favorites

1. Select Options on the Tools menu or click the Options button to have the Options screen displayed. Then select the Favorites check box and click OK.

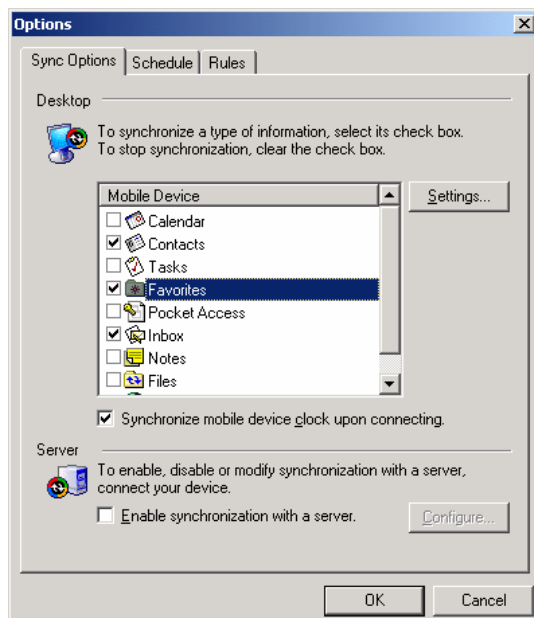

2. Select Create Mobile Favorites on the Tools menu of Microsoft Internet Explorer of your desktop PC.

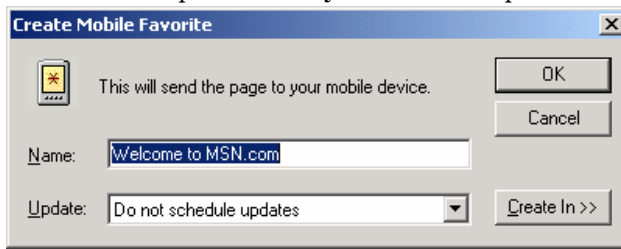

3. When you select OK, the Internet Explorer will download the latest version of the corresponding page. Then you will find the icon() on the task tray bar of your desktop PC.

To make the Mobile Favorites button on the Tools menu of your desktop PC

Select Tools bar > Customize on the View menu of Microsoft Internet Explorer to add the Mobile Favorites button on the Tools bar.

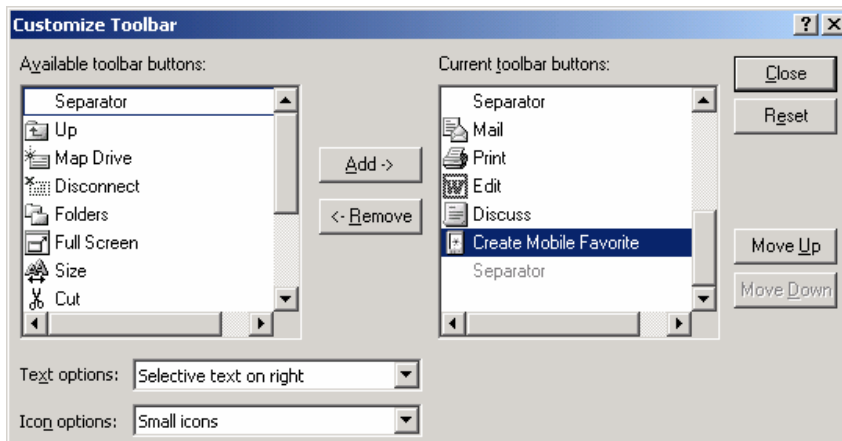

Select Create Mobile Favorites on your left pane and click the Add button to send that item you select to the right pane as described above. Then you will find the Mobile Favorites() button on your tools bar of your Microsoft Internet Explorer.

To reduce the amount of memory caused by Mobile Favorites

Mobile favorites take up storage memory on your device. Follow these tips to minimize the amount of memory used:

- Use ActiveSync settings to turn off pictures and sounds for the Mobile Favorites or to stop some mobile favorites from being downloaded to your device. For more information, see ActiveSync Help.

1. Select Options on the Tools menu or click the Options button to have the Options screen displayed.

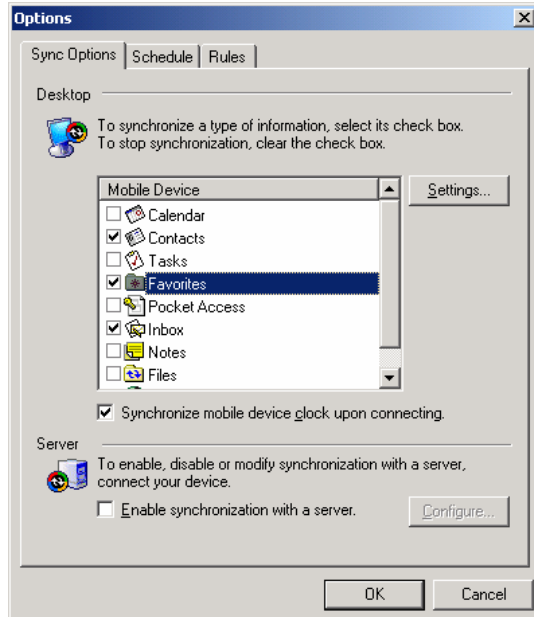

2. Then select the Favorites check box and click the Settings button.

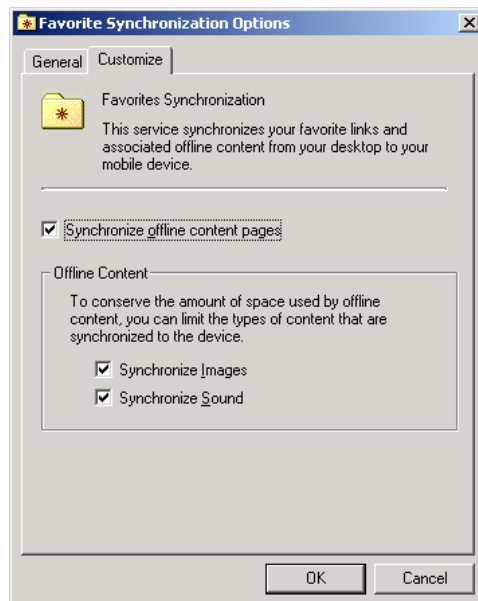

3. Deselect pictures and sounds for the Mobile Favorites and click OK.

To view Mobile Favorites offline

1. Tap the Favorites button on Pocket Internet Explorer of your device to display your list of favorites.

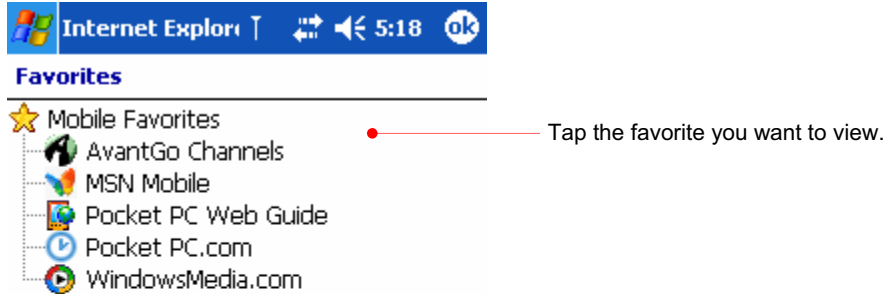

2. In the list, tap the page you want to view.

Sending and Receiving E-Mail Messages

If you have an e-mail account with an ISP or on a corporate network, you can use Messaging to send and receive e-mail messages in two ways:

- Synchronize messages with Microsoft Outlook on your desktop PC.
- Send and receive messages by connecting directly to an e-mail server through an ISP or a network.

Synchronizing E-mail Messages

You can synchronize e-mail messages as part of the general synchronization process whenever you connect your device to your desktop PC. First, you must enable Inbox synchronization in ActiveSync.

Select the Options button on the Microsoft ActiveSync screen.

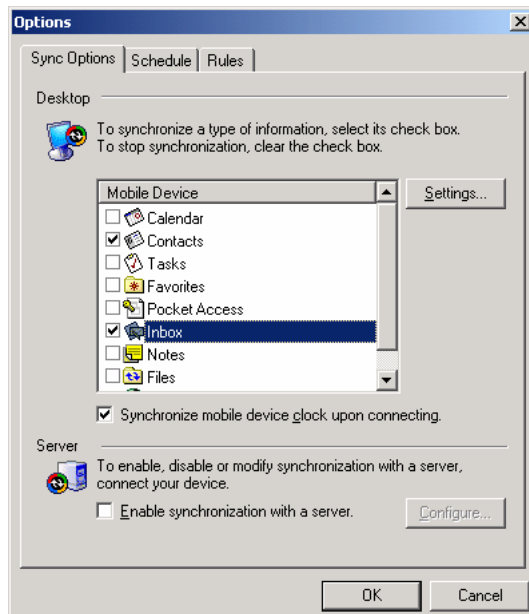

Select Inbox and click the Settings button.

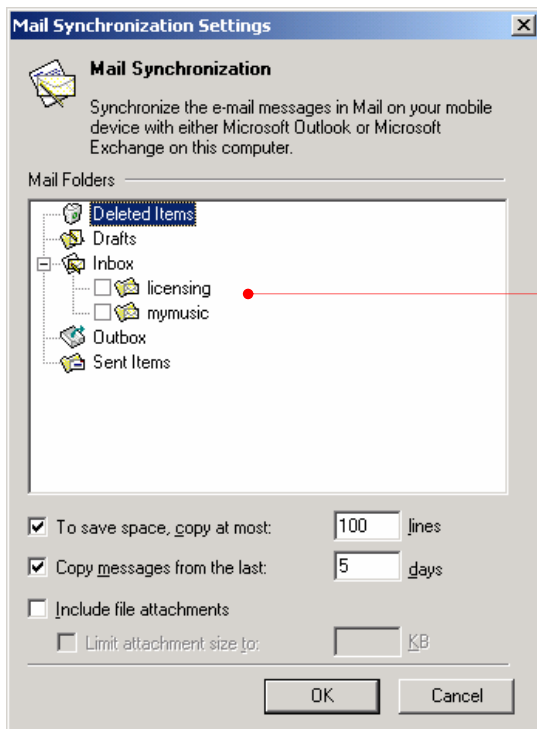

Select the folders you want to synchronize.



Make selections as you want and click OK to copy the Inbox folder of your desktop PC to the Inbox folder of your device.



Here is the list of mail messages after you synchronize through ActiveSync.



Shows you this is a mail message with attachments that need to be downloaded.



Shows you this is a read mail message.

-  This is unread message.
-  This is unread message with attachments that need to be downloaded.

-  This is already read message.
-  This is read message with attachments that is already downloaded.

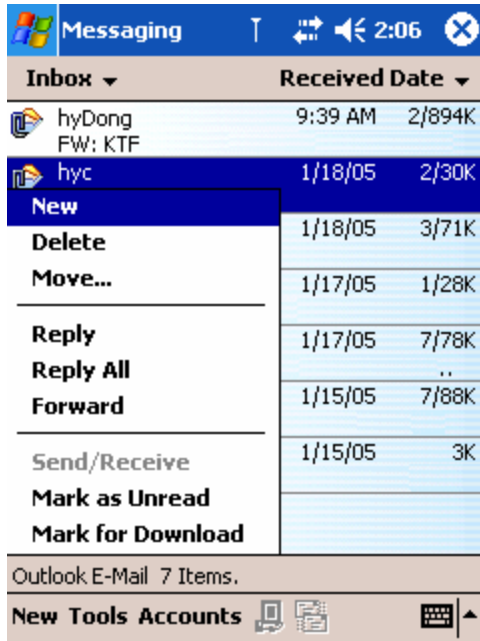
If you want to download the attachments, tap and hold the corresponding message to have pop-up menu displayed. Then select Mark for Download.



Then this  icon will be changed to .

Using the Message List

Messages you receive are displayed in the message list. By default, the most recently received messages are displayed first in the list.

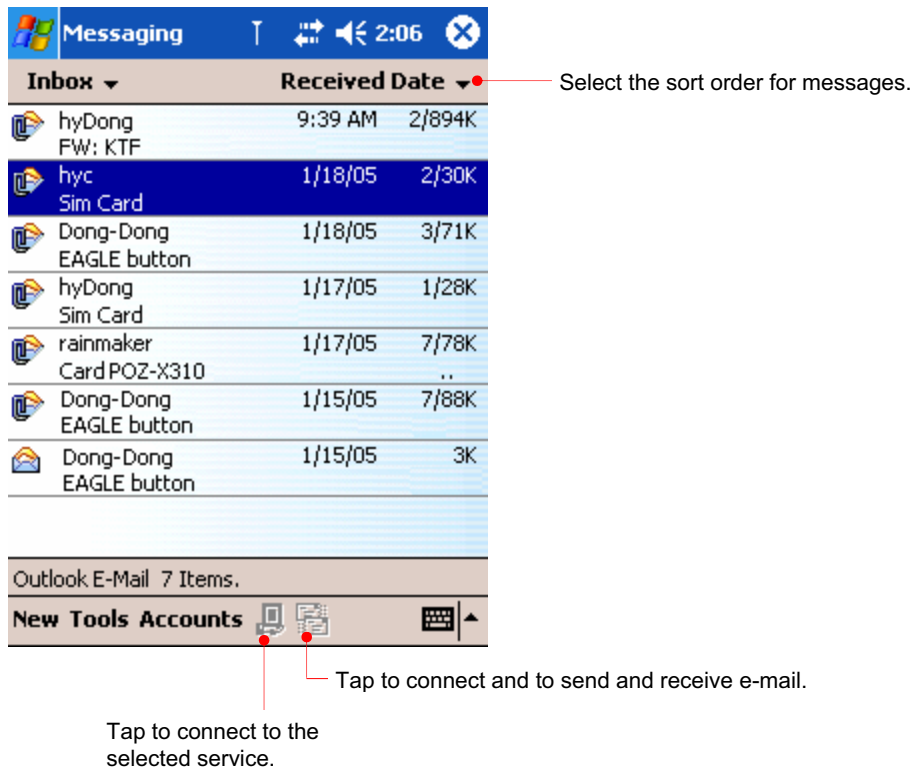

When you receive a message, tap it to open it.

