

# Table of Contents:

<b>INTRODUCTION</b>	<b>3</b>
<b>Features</b>	<b>3</b>
<b>Built-in VLAN support</b>	<b>5</b>
<b>PACKAGE CHECKLIST</b>	<b>7</b>
<b>QUICK INSTALLATION</b>	<b>9</b>
<b>PRODUCT OVERVIEW</b>	<b>13</b>
<b>Front Panel</b>	<b>13</b>
<b>VLAN LEDs and control buttons (RES-1002V only)</b>	<b>15</b>
<b>Back Panel</b>	<b>16</b>
<b>Stacking brackets</b>	<b>17</b>
<b>APPLICATIONS</b>	<b>19</b>
<b>Collapsed backbone</b>	<b>19</b>
<b>Departmental bridge</b>	<b>20</b>
<b>High performance workgroup bridge</b>	<b>20</b>
<b>HARDWARE INSTALLATION</b>	<b>23</b>
<b>Pre-installation requirements</b>	<b>23</b>

## Copyrights and Liabilities

Copyright © 1998 CyberTAN Technology Inc. All rights reserved. No part of this publication may be reproduced or transmitted in any form by any means for any purpose without the prior written permission of CyberTAN Technology Inc.

The information in this manual is subject to change without notice and does not represent any commitment on the part of CyberTAN Technology Inc. CyberTAN Technology Inc. also specifically disclaims any implied warranties of merchantability or fitness for any particular purpose.

The software described in this document may be copied and used by one intended user only, unless otherwise stated, and the copying should be solely for the purpose of backup.

In the event the product this manual supports is not free from defects, the purchaser's sole remedy shall be repair or replacement within the warranty period. By acceptance of this product, you hereby assume all liability consequent to your use or misuse of it. CyberTAN Technology Inc. assumes no liability for incidental, special or consequential damage of any kind. Under no circumstances will CyberTAN Technology Inc. be liable for any expenses, lost profits, lost savings, damage to or replacement of equipment and property, costs of recovering, reprogramming, or reproducing any data stored in or used with this product.

CyberTAN and the CyberTAN logo are registered trademarks of CyberTAN Technology Inc. All other company names and product names are trademarks and registered trademarks of their respective owners.

## FCC Notice

This equipment has been tested and found to comply with the limits for a Class B digital device, pursuant to Part 15 of FCC Rules. These limits are designed to provide reasonable protection against harmful interference in a residential installation. This equipment generates, uses, and can radiate radio frequency energy and, if not installed and used in accordance with the instructions, may cause harmful interference to radio communications. However, there is not guarantee that interference will not occur in a particular installation. If this equipment does cause turning the equipment off and on, the user is encouraged to try to correct the interference by one or more of the following measures:

1. Reorient or relocate the receiving antenna.
2. Increase the separation between the equipment and receiver.
3. Connect the equipment into an outlet on a circuit different from that to which the receiver is connected.
4. Consult the dealer or an experienced radio/television technician for help.

## Safety Precautions

1. Follow all warnings and instructions marked on the product.
2. Slots and openings on the device are provided for ventilation. To protect it from overheating, these openings must not be blocked or covered.
3. Do not subject the product, even if it is not plugged in, to an environment that exceeds temperature and humidity specifications. This product should never be placed near or over a radiator or heat register, or in a built-in installation unless proper ventilation is provided.
4. Unplug this product from wall outlet before cleaning. Do not use liquid cleaners or aerosol cleaners. Use a damp cloth for cleaning.
5. Do not place cords or cables where they may be walked on or tripped over.
6. Be sure to comply with any applicable local safety standards or regulations.
7. General purpose cables are provided with this product. Any cables or other requirements mandated by local authority are your responsibility.
8. Cables that are attached to devices in different locations that have different power sources and grounding may have hazardous voltage potentials. Consult a qualified electrical consultant before installing the product to see if this phenomenon exists and, if necessary, take corrective action.
9. Never touch unannounced telephone wires or terminals unless the line has been disconnected.
10. Avoid using telephone equipment or installing the product during an electrical storm.
11. Never install telephone jacks, lines, network cables, this product, or power connections in wet locations.
12. Never spill liquid of any kind on the product.

<b>Mounting the Switch</b>	<b>24</b>
<b>Connecting the Switch</b>	<b>26</b>
<b>Setting the Communication Mode</b>	<b>28</b>
<b>VLAN configuration(RES-1002v only)</b>	<b>28</b>
<b>Power on and diagnostic tests</b>	<b>29</b>
<b>VLAN grouping</b>	<b>29</b>
<b>Connecting a power supply</b>	<b>31</b>
<b>Testing</b>	<b>31</b>
<b>Running</b>	<b>31</b>
<b>APPENDIX A: TROUBLESHOOTING</b>	<b>33</b>
<b>APPENDIX B: TECHNICAL SPECIFICATIONS</b>	<b>35</b>
<b>APPENDIX C: PRODUCT SUPPORT AND SERVICE</b>	<b>37</b>

## Introduction

The RES-1002(v)/1802 Switch provides improved network performance and dedicated switch access with 8/16 10Mbps ports plus 2 10/100Mbps dual-speed ports. The two Fast Ethernet ports provide high-speed connectivity to a high-end servers, corporate networks and power users. Easy installation lets you increase your total network capacity without requiring you to replace or add any other equipment.

Each port on the Switch can be configured as half duplex mode for connection to shared media, or as a dedicated full duplex link, running at up to 20Mbps for the 10BASE-T port and to 200Mbps for the 100BASE-TX port. The Switch is plug-and-play with no software to configure. Individual front panel LEDs clearly indicate port status, simplifying installation and troubleshooting.

In addition to plug-and-play installation and easy configuration, the RES-1002v Switch also features built-in Virtual LAN (VLAN) supports. Up to 4 port-based VLAN groups can be configured for Multicast and Broadcast frames. Traffic in different segments and subnets can be separated for maximum throughput and secure networking.

## Features

The feature list for the RES Switch includes:

- Conforms to IEEE 802.3 10BASE-T and IEEE 802.3u 100BASE-TX standards
- RES-1002/1002v: 10 Ethernet RJ-45 ports; including 8 10BASE-T RJ-45 and 2 10BASE-T/100BASE-TX auto-negotiation RJ-45 ports
- RES-1802: 18 Ethernet RJ-45 ports; including 16 10BASE-T RJ-45 and 2 100BASE-TX RJ-45 ports
- VLAN support (RES-1002v): Supports port-based Virtual LANs (VLANs), up to 4 VLAN groups can be created to extend the broadcast domain, segment network traffic, and improve performance and manageability.
- CyberControl (RES-1002v): Easy VLAN configuration by CyberControl front panel buttons
- Port 1, 2 supports 10BASE-T/100BASE-TX auto-negotiation.
- All ports support half and full duplex transmission modes
- One MDI-II RJ-45 10/100Mbps Uplink port
- Modified Cut-through switching architecture
- Comprehensive LEDs indicate power, link, activity, full duplex, and collision operation
- 30K (RES-1002/1802) and 1.9K (RES-1002v) of maximum active MAC address entry table with self learning and table aging
- 1MB (RES-1002) and 2MB (RES-1802) shared buffer memory

### Built-in VLAN support

VLAN allows the grouping of end-stations logically, based not on physical location but on business policies such as job function or department. Members of a group can be dispersed throughout a facility - they do not have to be connected in close physical locations. Hence, group members can coordinate their data communication requirements regardless of the actual working locations; and the logical network can extend to any point you want it to. Moreover, VLAN groups can be modified at any time to add, move or change users without any re-cabling.

VLAN is useful in limiting the effects of broadcast traffic within a segment. So a group member can broadcast only to other members of the same group. With VLAN, IS managers can segment their networks to effectively control broadcast traffic and to avoid unwanted collision.

The RES-1002v is the first port-based switch that can be configured without software. By creating 4 full-bandwidth LAN segments, the Switch's port-based VLANs reduce broadcast traffic and prevents power users from overloading the network.

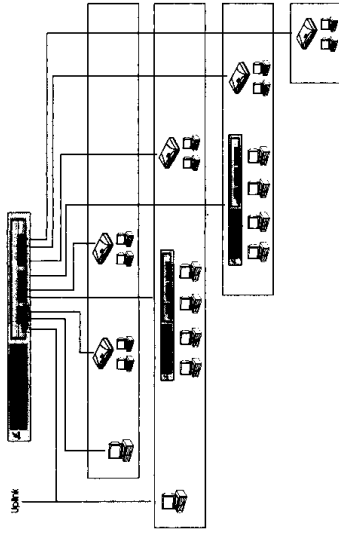
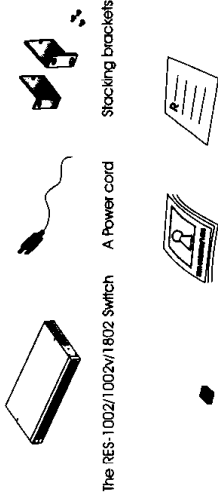

Figure 1: Network segmentation using VLAN

### Package checklist

Carefully unpack the content of the RES-1002(v)/1802 Switch and verify them against the checklist given below.

- The RES-1002(v)/1802 Switch
- An AC Power cord
- Two Racking brackets
- Four rubber foot pads
- This user's manual
- A registration card



Four rubber foot pads This user's Manual A registration card

Figure 2. RES-1002(v)/1802 package list

If there are any incorrect, missing or damaged part, please inform your local dealer for service. Please keep the carton and original packaging materials if possible in case you need to return the Switch for repair.

### Quick Installation

If you are already familiar with basic network operations, you can install the Switch as described below:

1. Unpack the Switch in the box. Make sure the content is correct with the package list.
2. Find a place within easy reach of an electrical outlet and other network devices.
3. Mount the Switch on a stable flat surface after applying the four rubber foot pads to each of the four shallow holes on the bottom corners of the Switch. If you are installing multiple Switches, you can stack them together using the supplied standard EIA 19-inch rack. (Refer to the Hardware Installation part of this manual.)

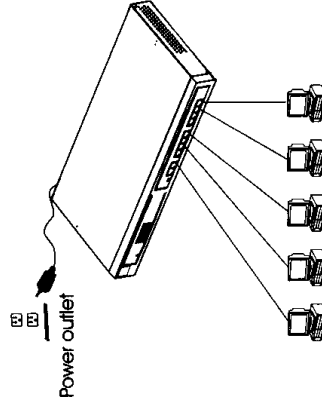

Figure 3. RES Ethernet switch connection

- 4. Connect 10BASE-T or 100BASE-TX devices (PCs, workstations and other equipment) to the Switch using standard network cables.

**Note:** If you plan to connect a PC or workstation that runs at 100Mbps to the 100BASE-T/100BASE-TX ports, make sure the device has a 10/100Mbps network interface.

- 5. To cascade to another switch or hub, use straight-through TP cable from the Port 1 Uplink port on this Switch to any station port on the other device. Or you can connect these two devices in the opposite direction vice versa. Make sure to turn the Uplink slide switch on the front panel to X (Uplink) mode before making an uplink connection.

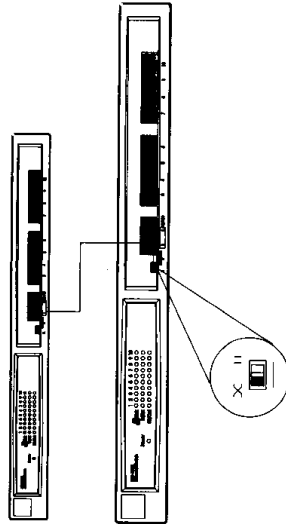

Figure 4. Cascade the Switch.

- 6. For 10BASE-T ports, you must manually set the transmission mode to half or full duplex mode using the HDX/FDX DIP switch on the back panel according to the attached device's transmission mode. Full duplex

mode can only be used for a device attachment. When connecting to a shared collision domain, set the transmission to half duplex. For 10BASE-T/100BASE-TX ports, they can auto-negotiate with the attached device to achieve an optimal communication speed and mode. (See the Hardware Installation part for detailed information.)

- 7. Connect the power cord to a nearby electrical outlet. Make sure that all necessary connections are well made and the Switch's indicator LEDs are functioning properly.

If you have any problems installing the Switch, refer to the Appendix A Troubleshooting for more information.

### Product Overview

The RES Switch is designed to meet several specific needs: to provide connectivity between computer users on shared 10Mbps hub segments and high-speed servers; to deliver affordable high-density switched 10Mbps bandwidth directly to the desktop; and to connect users to centralized servers located in data centers, via high speed 100BASE-TX links.

### Front Panel

There are 2 10BASE-T/100BASE-TX ports and 8/16 10BASE-T Ethernet ports, and a Uplink slide switch on the front panel of the Switch.

Also on the front panel are LED indicators that show the status of the Switch. Users can easily view the state of every port from the front panel.

### LED Indicators

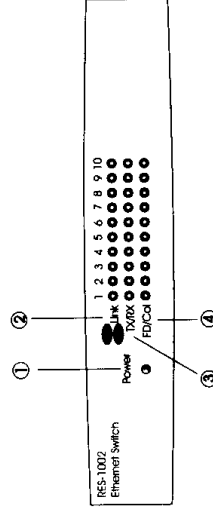

Figure 5. RES switch LED (Panel RES-1002)

① Power

**Green:** This indicator lights Green when the Switch is connected to a power outlet.

**⑩/10/100 Link (per port)**

**Orange:** The indicator lights Orange when a 10Mbps device is connected to the 10BASE-T or 100BASE-TX port.

**Green:** The indicator lights Green when a 100Mbps device is connected to the 10BASE-T/100BASE-TX auto-sensing ports.

**Off:** It goes off when no device is attached to the correspondent port.

**⑪TX/RX (per port)**

**Off:** The indicator goes off when there is no data transmitted.

**Green:** The indicator lights Green when there is a reception or transmission of a packet occurring at correspondent port.

**⑫FDX/Col (per port)**

**Orange:** This indicator lights Orange when a respective port is in full duplex (FDX) mode.

**Flashing Orange:** It flashes when a respective port is connected in half duplex (HDX) mode with collision.

**Off:** It goes off when in half duplex mode and no collision occurred.

**Interfaces**

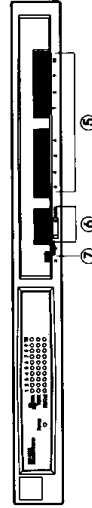

Figure 6. RES switch interfaces (Panel RES-1002)

**⑮10BASE-T Ethernet ports**  
8/16 10BASE-T RJ-45 ports.

**⑯10 BASE-T/100BASE-TX Ethernet ports**  
2 10/BASE-T/100BASE-TX auto-sensing RJ-45 ports. Port 1 is 'switch selectable' using the Uplink slide switch next to it.

**⑰Uplink slide switch**

The DIP switch can be used for configuring Port 1 for a normal (to connect to other devices using a straight-through TP cable) or an uplink (to connect directly to a central hub or to other cascaded devices) connection.

**VLAN LEDs and control buttons (RES-1002V only)**

In addition to the above LEDs, the RES-1002v also includes VLAN group indicators and two push buttons for configuration.

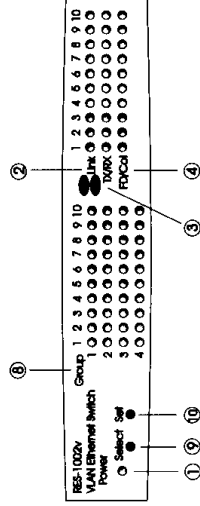

Figure 7. VLAN LED panel

**⑱Group LEDs**

The indicators light Green to show the port status of each VLAN group. The 1 - 10 LEDs on the horizontal direction indicate different ports on



the Switch, and the 1 - 4 LEDs on the vertical direction indicate 4 VLAN groups.

**ⓈSelect**

Use the button to select the ports which you want to group in a VLAN.

**ⓉSet**

Use the button to assign different ports to different broadcast domains. For more information of port and VLAN group setting, refer to the VLAN configuration part of the manual.

### Back Panel

On the back panel of the Switch are two internal cooling fans, power socket, power switch and transmission mode DIP switch. The power socket is for standard 3-pin AC power cord that comes with the Switch. The HDX/FDX DIP switch is for setting Port 3-10/18 to full or half duplex transmission mode. For proper ventilation, 10cm (4 inches) space around the Switch.

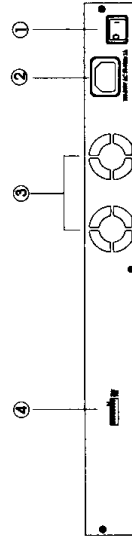

Figure 8. RES switch back panel

**ⓅPower switch**

The power switch turns the unit on and off.

**ⓅPower socket:** The power socket supports the AC power cord that comes with the RES Switch. Do not use any other power cord for powering the Switch.

**ⓆCooling fans:** Two internal cooling fans are installed inside for optimum air-flow to safeguard the Switch from unnecessary heat exposure. Please keep these fans clean and away from objects for at least 10cm(4 inches).

**ⓇHDX/FDX DIP switches:** Use the DIP switches to set the half and full duplex transmission mode of the Port 2-10/18.

### Racking brackets

There are two standard 19-inch EIA racking brackets in the package. These two brackets can be used to place the RES Switch onto the rack.

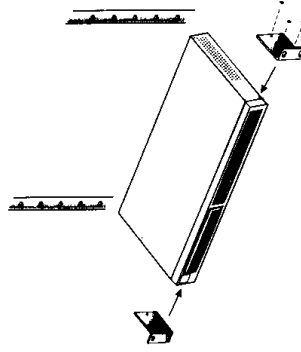

Figure 9. Racking brackets

Use a screwdriver to turn the screws on them to secure the brackets into the stacking holes.

## Applications

The Switch can act as a high-performance workgroup or backbone connection. The following applications are recommended.

### Collapsed backbone

For small network where substantial growth can be expected, this Switch is an ideal solution supporting backbone connectivity. The switching 10BASE-T port can connect to a hub in half duplex mode, or an end node in full/half duplex mode; while the switching 10BASE-T/100BASE-TX ports can connect to a high-speed server to build up a 200Mbps full duplex connection.

When the network needs expansion, you can simply connect the Switch to another Ethernet hub or switch using the Port 10BASE-T/100BASE-TX Uplink port. This switch can also cooperate with a wide range of networking devices (e.g., firewall routers and printer servers) added to the network.

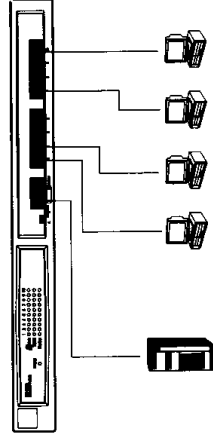

Figure 10. Collapsed backbone application

**Departmental bridge**

For enterprise network where large data broadcasts are processed, this Switch is an ideal solution for department users to connect to the corporate backbone. The 10BASE-T/100BASE-TX port can provide up to 200Mbps bandwidth to collapsed backbone, while departmental hubs and stations can connect to 10BASE-T switching ports. High-speed department servers that need high bandwidth can connect to the 10/100Mbps port.

The switching department connection can reduce latency to near-zero level and thus significantly enhance network performance.

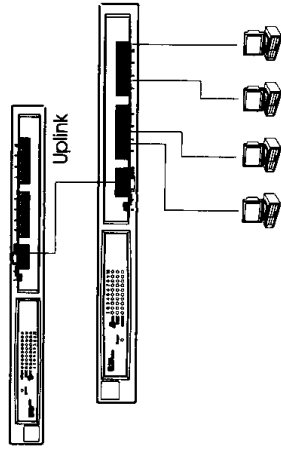

Figure 11. Departmental bridge application

**High performance workgroup bridge**

This Switch is also a good solution for connecting two workgroups, supporting up to 200Mbps speed. This application is useful for power groups that need high bandwidth. Switching to high-speed yet expensive FDDI or ATM units is not affordable to most users. In addition to their high costs, users will have to replace all existing Ethernet cable, adapter

cards, restructure the network and implement more expensive administration procedures.

The Switch can provide the same bandwidth of FDDI and ATM at much lower costs. All current adapters and network devices can still be used. The switching cross-domain connection is better than bridge and router because users can retain LAN structure in which any node can freely communicate with any other node.

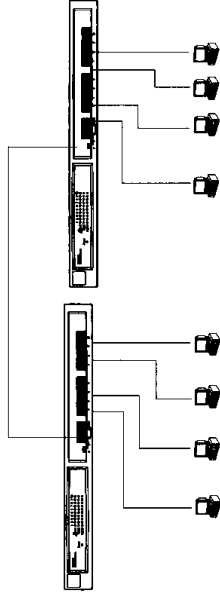

Figure 12. Workgroup bridge application

## Hardware Installation

### Pre-installation requirements

Before you start hardware installation, make sure your installation environment has below items:

- **PCs with 10BASE-T/100BASE-TX Ethernet network cards:** Your PC or device must have a 10BASE-T or 100BASE-TX Ethernet interface to connect to the Switch.
- **UTP network cable with RJ45 connectors:** Check if the cable and connectors work properly. Remember the maximum length of each cable cannot exceed 100 meters (328 feet).
- **A Power outlet:** 100 to 240V AC at 50 to 60 Hz.
- **A dry cool place:** Keep the Switch away from moisture. Avoid direct sunlight, heat source, and high amount of electromagnetic interference around.
- **(Optional) Mounting tools:** if you intend to mount the switch on a rack, make sure you have all the tools, mounting brackets, screws, bolts and nuts.

**Caution:** Avoid strong electromagnetic interference sources in your environment, such as radio, computers, TVs, hair dryers, and microwave.

When planning the site of your network devices, try to keep them away from sources of strong electromagnetic interference, that may, in certain degrees, affect the accuracy of the packet.

### Mounting the Switch

The RES-1002(v)/1802 Switch is suitable for use in an office environment where it can be rack-mounted in standard EIA 19-inch racks or stand alone.

#### Desktop mounting

You can set the Switch on a sufficiently large flat space. Find a place with a power outlet nearby, and about the center of all networked devices. Apply the rubber foot pads to each of the four shallow holes on the bottom corners of the Switch. These pads cushion the Switch against shock/vibrations. Then place the Switch on a firm flat surface where the unit is installed.

If you want to stack several Switches one over another in a rack, remember to firstly attach the rubber footpads on each of the four hollow spaces on the bottom of the Switch for vibration cushion and ventilation.



Figure 13. Mount the Switch on a tabletop  
Rack mounting

To stack multiple Switches in a standard 19-inch EIA rack, use the supplied mounting kit that comes with the Switch. This kit contains two side-mounting brackets, six bracket screws, and four larger rack-mount screws. You will need a screwdriver or other tools to install the rack-mounting hardware.

Follow these steps to rack mount the Switch:

1. Position the bracket to align with the holes on the Switch and secure it with the smaller bracket screws. Then attach the remaining bracket to the other side of the Switch.
2. After you attach both racking brackets, position the Switch in the rack by lining up the holes in the brackets with the appropriate holes on the rack. Then, secure the Switch to the rack with a screwdriver and the supplied rack-mount screws.

**Note:** For proper ventilation, allow at least 4 inches (10 cm) of clearance on the front and 3.4 inches (8 cm) on the back of the Switch. This is especially important for enclosed rack installations. The Switch requires 2 inches (5 cm) of top clearance.

You can apply the procedures to stack more RES Switches.

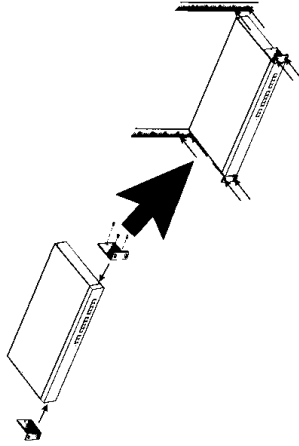

Figure 14. Mount the Switch onto the rack

To remove a rack, use a screwdriver for loosening all the screws on the rack and the stacking brackets from the body.

### Connecting the Switch

The Switch provides a range of options in setting up network connections. The unit can connect to a workstation, server, bridge or router. It can also cascade to another compatible switch or hub by connecting an Normal(MDI-X) port on one device (for example, the Uplink port on this switch) to an MDI-X port on the other device. Or you can cascade from an MDI port on another device to any Normal(MDI-X) port on this switch.

### Making a connection via Normal ports

You can connect the Switch to other devices (hubs, workstations, servers, and so on) using Category 3, 4, or 5 TP cables. Use Category 5 cable for 100Mbps Fast Ethernet connections, and Category 3, 4 or 5 cable for standard

10Mbps Ethernet connections. The distance between a port and an attached device cannot exceed 100 meters when using TP cabling.

Connect one end of the cable to the RJ-45 port of the device's network interface card, and the other end to the correspondent Normal port (either 10BASE-T or 100-BASE-TX) on the Switch. When inserting an RJ-45 plug, make sure the tab on the plug clicks into position to ensure that it is properly seated. Using the Switch in a stand-alone configuration, you can connect up to 10/18 endstations.

### Making a connection via the Uplink port

If you want to connect the Switch to another compatible hub, switch or repeater, use the Port 1 Uplink port and a standard straight network cable for connection. Make sure to turn the DIP Switch on the front panel to Uplink side before an uplink connection.

Then use Category 5 TP cable for 100Mbps Fast Ethernet connections, or Category 3, 4, 5 TP cable for 10Mbps Ethernet connections. The cable length for each connection should not exceed 100 meters (328 feet). Connect one end of the cable to the Uplink port (Port 1) on this Switch, and connect the other end to a standard MDI-X station port on the other device.

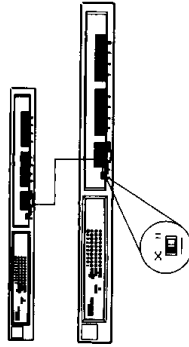

Figure 15. Making a connection via the Uplink port

When a port is connected to another switch, the cooperation of switches can provide a dedicated temporary link for two nodes in the same physical network.

### Setting the Communication Mode

The transmission mode for each port must be set to the same mode used by the connected device. For 10BASE-T ports, manually set the transmission mode to half or full duplex using the HDX/FDXDIP switch on the back panel according to the attached device's transmission mode. When connect to a shared collision domain, set the transmission to half duplex. For 10BASE-T/100BASE-TX ports, them can auto-negotiate with the attached device to achieve an optimal communication speed and mode.

### VLAN configuration(RES-1002v only)

The Switch defines VLAN membership by groups of switch ports (for example, Port 1, 2, 3 on a switch make up VLAN A, while Port 4, 5, and 6 make up VLAN B).

The RES-1002v supports CyberControl design-a proprietary method to configure VLAN grouping. By using the Select and Set buttons on the front panel, users can configure up to four groups with LEDs showing status. The CyberControl can avoid hassles of network software configuration.

### Power on and diagnostic tests

After you turn the Switch on, the unit will automatically perform a diagnostic test. The Power indicator and VLAN group LEDs will blink for around ten seconds, automatically performing a diagnostic test. When the diagnostic test is completed, the LEDs will display port-based VLAN status.

### VLAN grouping

The Switch enables you to create up to four port-based VLANs. In the factory default state, VLANs are not configured. All ports belong to the same broadcast/multicast domain.

Follow these steps to configure VLAN groups:

1. Make sure the power is on. Push the Select button on the front panel, the Group LEDs will start to blink. Use the button to select the ports which you want to assign to a specific VLAN group.

Note: Whenever you select a desired ports, please push the Set button about one second or wait for 10 seconds to complete the setting, otherwise the unit will detect the move as a false alarm and ignore the setting.

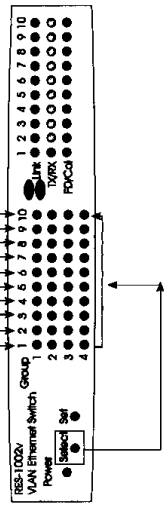

Figure 15: Choose VLAN port using the Select button

2. Push the Set button, the VLAN group LEDs will also blink. Use the button to assign different ports to different VLAN groups. You can move to the target group and hold the button for more than one second to force the unit to store the setting. Or you can stay in the same group for ten seconds before next configuration and the unit will automatically store the setting.

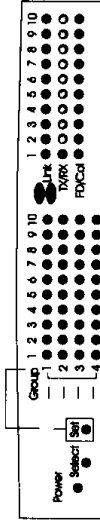

Figure 16: Choose VLAN groups using the Set button

3. When the configuration is completed, the unit will automatically detect the operating time. If you do not process any other configuration in ten seconds, the front panel LEDs will indicate normal port status.

### Connecting a power supply

After all network cables are connected, plug the power cord into the power socket on the back panel and the other end into a power outlet. Turn the power on using the power switch on the back panel. Check the front panel Power indicator to see if power is properly supplied. The Switch uses a universal power supply that requires no additional adjustment.

### Testing

Check the front panel indicators to see each port status. If the port is used, you can see the Link indicator is on.

Be sure the media cable is properly attached to the connected device and the Switch.

### Running

Once running, you can check the status of the Switch from the front panel's indicators.

After the installation, the Switch is maintenance-free. If you want to add a station to your network, just connect the station and the Switch with a standard network cable.



## Appendix A: Troubleshooting

If your Switch is not working, please follow below procedures to solve your problems.

### **Check if all equipments are powered on.**

#### **Check the attached device to see if it works properly.**

The following are some common problems that could occur with the Switch, possible reasons for the problems, and possible steps to take to solve the problems. Read below description to solve your problems.

### **Power LED not lit**

Check the power cord connection. If the power cord is connected to the Switch, check both ends of the power cord to make certain that they are securely connected to the power receptacle on the Switch and power outlet.

If both ends of the power cord are properly connected and there is still no power, the device might have a faulty power outlet or power cord. Change a power outlet or get another power cord from your dealer.

### **Port Status LED not lit for a connected port**

Check if the device being connected is powered on, operating correctly and well connected. Also check if the cable is "straight-through" for an end device, and make sure connectors at both ends of cable are securely seated. If the problems