

# UIW8001 and UIW4001 Ultra High-Definition IP Set-Top Boxes Installation Guide

## Contents

Change the Way You Watch TV.....	4
Identify Your Set-Top Box.....	4
Safety First.....	5
Serial Number .....	5
In This Manual.....	5
Open Source Software Notification.....	5
UIW8001 and UIW4001 Front Panels .....	6
UIW8001 and UIW4001 Back Panels.....	7
Connecting the Set-Top Box.....	8
Connecting to the In-Home Network.....	9
Connection for IPV5050 Wireless Set-Top Box.....	9
Connections for a High-Definition TV (HDTV) .....	10
Connections for a Standard-Definition TV (SDTV) .....	11
Connections for a VCR or DVD Recorder .....	12
Connections for an Over-the-Air Converter Box.....	12
Connecting to an HDTV with an HDMI Connector.....	13
Connecting to an HDTV with a DVI Connector.....	14
Connecting to an HDTV with a Mini-DIN Connector.....	15
Connecting to an SDTV with a Mini-DIN Connector.....	16
Connecting to a Stereo VCR or DVD Recorder (optional).....	17
Troubleshooting.....	18
Frequently Asked Questions.....	19
Picture Formats .....	20

## Change the Way You Watch TV

Welcome to Internet Protocol Television (IPTV). The UIW8001 and UIW4001 Ultra High-Definition Set-Top Boxes bring a rich, new set of interactive services directly to you through your TV and your in-home IP network.

Available services may include some or all of the following features:

- Digital Video Recorder (DVR)—Allows you to record your favorite programs so that you can still go to your friend's house for dinner and not miss your favorite TV show
- Pause Live TV—Allows you to pay for the pizza and come back to the show where you left it (Applies to DVR models only)
- Ultra high-definition (UHD) - Provides crystal-clear pictures and sound when compared to high-definition (HD) and standard-definition (SD) – you won't want to watch television any other way once you've experienced UHD
- Video-On-Demand (VOD)—Gives you access to a robust library of movies and programs that you can watch – when you want to watch them

**Note:** Contact your service provider to find out if the DVR, HD, or VOD services are available and to activate the services.

## Identify Your Set-Top Box

This installation guide covers the following set-top box models. Use the following information to identify your model.

- UIW4001 set-top box - TV set-top box that supports ultra high-definition (UHD), high-definition (HD) and standard-definition (SD) video with MPEG2, H.264, and H.265 (HEVC) decoding. Supports 480i, 480p, 576i, and 576p on the analog video outputs and 720p, 1080i, 1080p24/30/50/60, and 4Kx2Kp24/25/30/50/60 on the HDMI output.
- UIW8001 set-top box - The UIW8001 is the same as the UIW4001, but with a 1TB HDD for DVR capability.

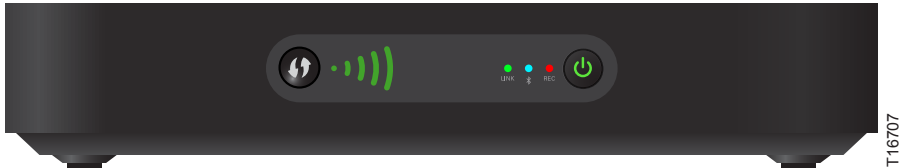

**Note:** This illustration may vary from the actual product.

## Safety First

Before using the set-top box, read the Important Safety Instructions included in the packaging with this Set-Top.

## Serial Number

At times your service provider may ask for the serial number. To find the serial number for your set-top box, look on the bottom of the set-top box for the label. The serial number is a 9-digit numeric code to the right of the letters "S/N" on the label.

Use the space provided here to record the serial number: \_\_\_\_\_

## In This Manual

This manual covers the information you need to connect your receiver to both your in-home IP network and your entertainment system. The manual also outlines certain safeguards and installation information.

## Open Source Software Notification

This product may contain certain open source software modules which are subject to Open Source Software license terms.

A list of the Open Source Software used or provided under this release and their corresponding Licenses and version number are available on Technicolor's website at the following address: <http://www.technicolor.com/en/hi/minisites/open-software> or at another address as Technicolor may provide from time to time.

If and where applicable, depending on the terms of the applicable Open Source Software licenses, the source codes of the Open Source Software are available for free on Technicolor's website at the following address: <http://www.technicolor.com/en/hi/minisites/open-software>.

For avoidance of doubt, Open Source Software is only licensed by the original owner of the Open Source Software under the terms set forth in the designated Open Source License.

## UIW8001 and UIW4001 Front Panel

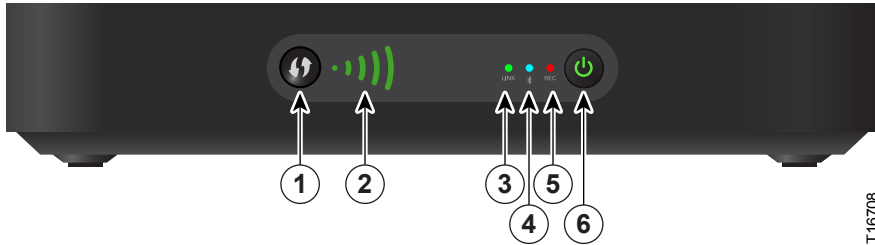

- 1 **WPS button** Press to pair with Wireless Access Point.
- 2 **Signal Strength Indicator** Identifies the strength of the wireless connection.
- 3 **Link LED** Indicates network link status. The LED is green.
- 4 **Bluetooth LED** Indicates when a Bluetooth Remote is paired with the set-top. The LED is blue.
- 5 **REC LED** Indicates that a recording is in progress. The LED is red.
- 6 **Power Button and LED** Powers on the set-top box or places it in standby. The LED is green when on and red when in standby.

**Note:** This illustration may vary from the actual product.



**CAUTION:** Your set-top box may be equipped with a hard disk drive to store programs that you record and to allow you to rewind and pause live TV. Any time the set-top box is powered on (power LED is illuminated) or a recording is in progress (the record LED is illuminated) the hard disk drive is in use.

If you need to move the set-top box, complete the following steps to allow the hard disk drive to shut down properly. First, make sure that no recording is in progress (record LED is off). Then, turn off power by pressing the Power switch. Finally, unplug the unit and wait 10 seconds for the hard disk drive to spin down (stop). At this point the unit can be moved safely.

You should handle this product with the same level of care that you would use when handling other electronics containing a hard disk drive, such as a laptop computer or other hard disk drive-equipped devices.

## UIW8001 and UIW4001 Back Panel

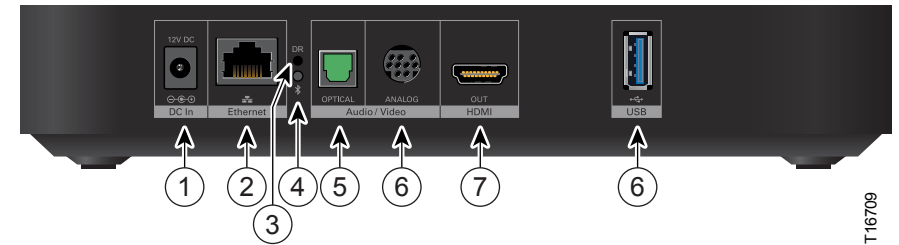

- 1 **Power** Connect the DC output of the AC power adapter (provided) to deliver power to the set-top box. Use only the AC power adapter provided with the set-top box.
- 2 **Ethernet** Connect to Ethernet (CAT-5) network at your home, if applicable.
- 3 **DR** Press and release to trigger a disaster recover recovery process.
- 4 **Bluetooth** Press and release to initiate Bluetooth remote control unit pairing with wireless receiver.
- 5 **Optical** Connect to an optical cable to send a digital audio signal to a surround sound system or other digital audio device.
- 6 **Analog Mini-DIN** Alternative method for video and audio connections. Offers analog component, composite, and stereo audio outputs.
- 7 **HDMI** Connect an HDTV HDMI (High-Definition Multimedia Interface) cable from the HDTV to the HDMI port. HDMI supports both digital audio and video. See **page 13** for more information
- 8 **USB 3.0** Allows connectivity with USB 3.0 devices.

**Note:** This illustration may vary from the actual product.

## Connecting the Set-Top Box

To connect your set-top box to your network and home entertainment devices, complete these steps:

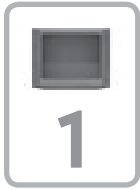

Because the connections for a high-definition (HD) or standard-definition (SD) TV are different, you must determine if your TV is HD or SD. Your TV must receive HD signals for you to enjoy the benefits of HDTV. See the guide that came with your TV for more information. See **page 20** for more information on picture formats.

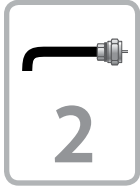
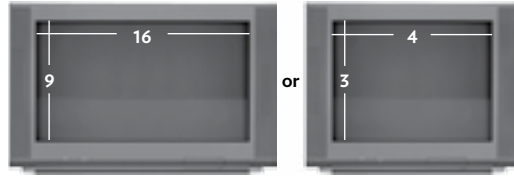

Make one of the following connections for your home network:

- If your home network uses Ethernet (CAT-5) cable, use the NETWORK connector on the set-top box. See **page 9**

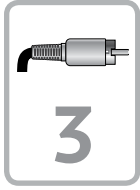

Make the connections for your TV, VCR, and DVD recorder as follows:

- If you are using an HDTV, see **page 10** and the connection diagrams in this guide.
- If you are using an SDTV, see **page 11** and the connection diagrams in this guide.



Identify the additional consumer electronic devices that you will connect to the set-top box and TV. See **page 12 through page 17** and see the owner's manual for the device.

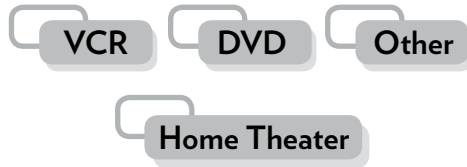

Plug the set-top box and the TV into an AC power source that is not controlled by a switch.

## Connecting to the In-Home Network

The following diagrams illustrate examples of the connections that you can use to connect your set-top box to your in-home network. Contact your service provider for the recommended connection method for your home.

**Note:** The illustration below may vary from the actual product

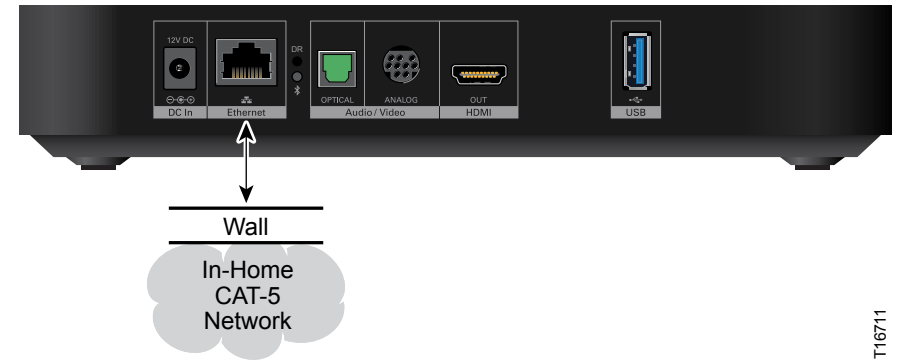

## Connection to Wireless network

The UIW8001 and UIW4001 set-top box allows for easy and secure establishment of a wireless home network through a Wireless Access Point. The signal strength indicator on the front panel of the set-top box allows you to identify the strength of your wireless connection.

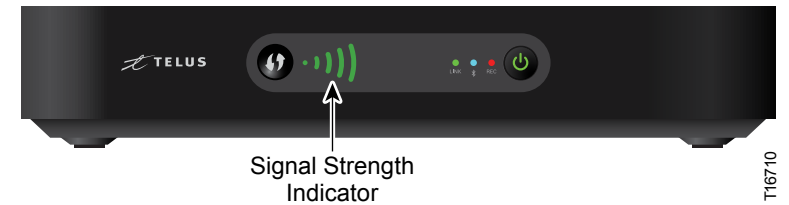













## Connections for a High-Definition TV (HDTV)

To use the set-top box with an HDTV, you must make *one* of the following connections to view the HD content. See the owner's manual for your TV and the cabling diagrams in this guide for more detailed connection information.

Although all connections provide you with quality service, we list the connections in our recommended order.

### Notes:

- The labeling on your set-top box or HDTV may vary slightly from the illustrations shown below
- Some cables shown in the connection diagrams may not be included with this set-top box
- Set the HD mode and select the output video format (480i, 480p, 720p, 1080i, 1080p) on the set-top box. See **page 20** for more information on picture formats

Use One of These Required Connections to an HDTV		Set-Top Box Connections		HDTV Connections
HDMI	Some HDTVs have a High-Definition Multimedia Interface (HDMI) connector. The HDMI connector provides both a digital video and audio connection. See the connection diagram on <b>page 13</b> for an example. <b>Note:</b> The HDMI port on the TV must support high-bandwidth digital content protection (HDCP).		Audio/Video	
		<b>Adapter Needed</b>		
DVI	The HDMI connector can provide the connection to an HDTV with a DVI input. If your HDTV has a Digital Visual Interface (DVI) connector, you need an HDMI-to-DVI adapter, and a separate audio connection (either L/R or optical audio). <b>Note:</b> The DVI port on the TV must support high-bandwidth digital content protection (HDCP). See the connection diagram on <b>page 14</b> for an example.		Video	
				Audio
				
YPbPr	The YPbPr (red, blue, and green) connectors provide high-definition component video signals to an HDTV, and a separate audio connection (either L/R or optical audio). See the connection diagram on <b>page 15</b> for an example.		Video	
				Audio
				
RGB	Some HDTVs have only RGB or RGB-HV connectors. If you have one of these HDTVs, you need a Component-to-RGB adapter, and you need a separate audio connection.		Video	
		<b>Adapter Needed</b>		Audio





## Connections for a Standard-Definition TV (SDTV)

When using the set-top box with an SDTV, you must make *one* of the following connections to view content. Some SDTVs may not have all of these connections. See the owner's manual for your TV and the cabling diagrams in this guide for more detailed information.

Although all connections provide you with quality service, we list the connections in our recommended order.

### Notes:

- The labeling on your set-top box or SDTV may vary slightly from the illustrations shown below
- Some cables shown in the connection diagrams may not be included with this set-top box

Use One of These Required Connections to an SDTV		Set-Top Box Connections		SDTV Connections
YPbPr	The YPbPr (red, blue, and green) connectors can provide standard-definition component video signals to an SDTV. A separate audio connection is also needed. <b>Note:</b> To connect YPbPr to an SDTV, you must select the output video format. See <b>page 20</b> for more information on picture formats. See the connection diagram on <b>page 16</b> for an example.		Video	
				Audio
Video Out	The Video Out connector provides a video connection to an SDTV. A separate audio connection is also needed. See the connection diagram on <b>page 16</b> for an example.		Video	
				Audio

## Connections for a VCR or DVD Recorder

When using the receiver with a VCR or DVD recorder, you must make one of the following connections to view content.

Although all connections provide you with quality service, we list the connections in our recommended order.

### Notes:

- The labeling on your receiver, VCR, or DVD recorder may vary slightly from the illustrations shown below.
- Some cables shown in the connection diagrams may not be included with this receiver.

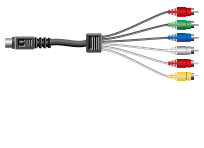
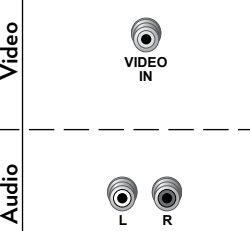
VCR/DVD Recorder	Use One of These Optional Connections to a VCR or DVD Recorder	Receiver Connections	VCR/DVD Recorder Connections
	<p>For VCRs or DVD recorders with Video In and Left and Right audio connectors, use the Video Out and the Audio Out connectors (Left and Right) on the receiver.</p> <p>See the connection diagram on <b>page 17</b> for an example.</p>		<p><b>Video</b></p> 

## Connections for an Over-the-Air Converter Box

You can connect an over-the-air converter box directly to your TV to receive certain local channels, but do not connect the over-the-air converter box directly to your set-top box box.

## Connecting to an HDTV with an HDMI Connector

### Cable Used in this Configuration

- 1 HDMI Cable

### Notes:

- The HDMI port on the TV must support high-bandwidth digital content protection (HDCP)
- The HDMI interface supports Dolby Digital 5.1 audio



**WARNING: Electric shock hazard! Unplug all electronic devices before connecting or disconnecting any device cables to the set-top box.**

Back of Set-Top Box

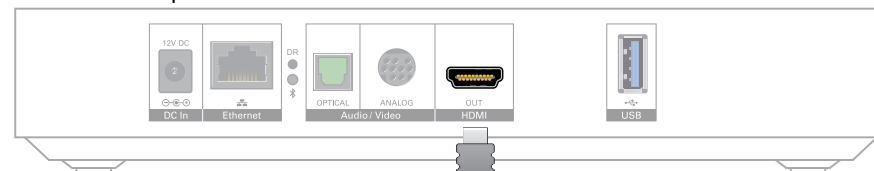

Back of HDTV

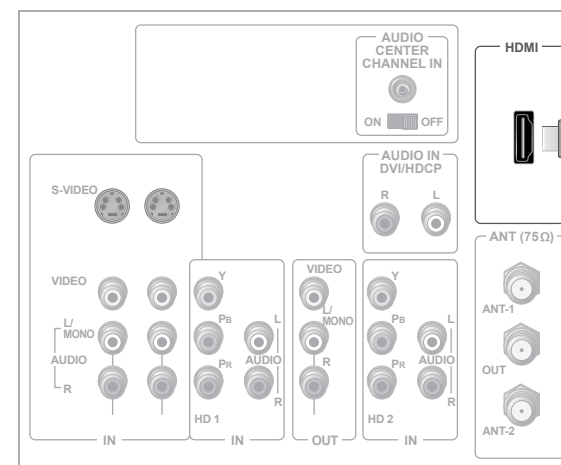

T16712

## Connecting to an HDTV with a DVI Connector

### Cables Used in this Configuration

- 1 HDMI-to-DVI cable or 1 HDMI cable and 1 HDMI-to-DVI adapter
- 1 Mini-DIN cable

#### Notes:

- The DVI port on the TV must support high-bandwidth digital content protection (HDCP)
- When you connect the HDMI connector to the DVI connector on your HDTV, you need an HDMI-to-DVI adapter and a separate audio connection

 **WARNING: Electric shock hazard! Unplug all electronic devices before connecting or disconnecting any device cables to the set-top box.**

Back of Set-Top Box

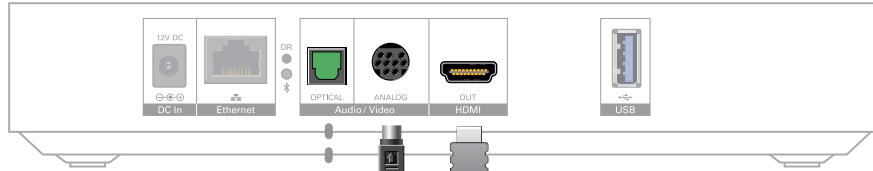

Back of HDTV

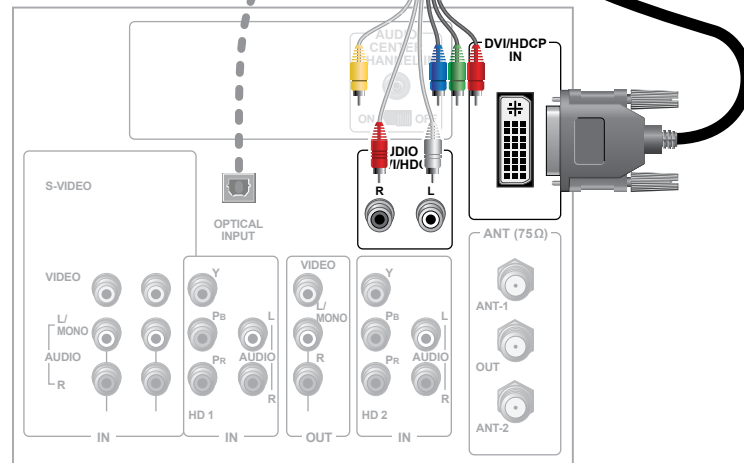

T16713

## Connecting to an HDTV with a Mini-DIN Connector

### Cables Used in this Configuration

- 1 Mini-DIN cable (You can also use an optical cable [indicated by the dotted line] instead of the Audio Left/Right Cable as shown in the diagram, dependent upon your TV's capabilities.)

 **WARNING: Electric shock hazard! Unplug all electronic devices before connecting or disconnecting any device cables to the set-top box.**

Back of Set-Top Box

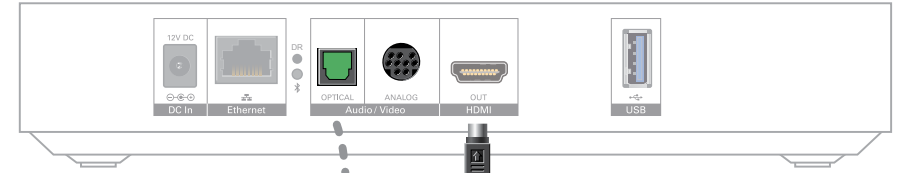

Back of HDTV

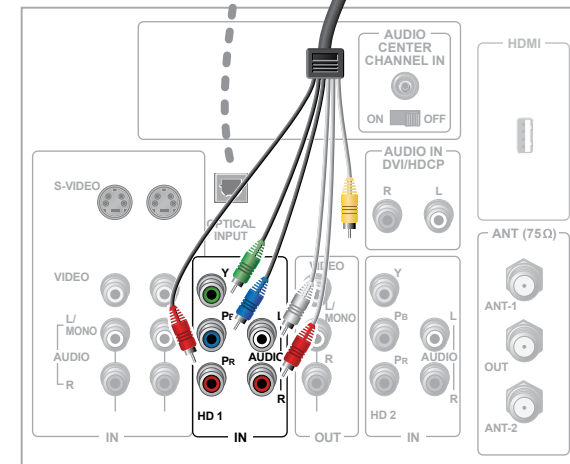

T16714



## Connecting to an SDTV with a Mini-DIN Connector

### Cables Used in this Configuration

- 1 Mini-DIN cable

**Note:** The set-top box must be set to the proper standard-definition mode.

#### Back of Set-Top Box

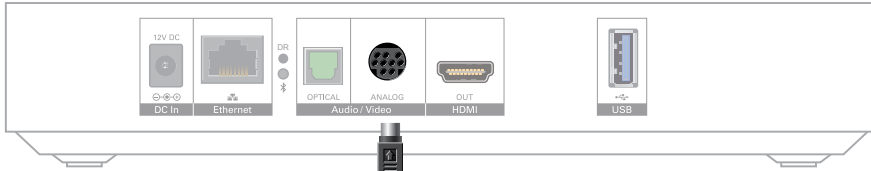

**⚡ WARNING:** Electric shock hazard! Unplug all electronic devices before connecting or disconnecting any device cables to the set-top box.

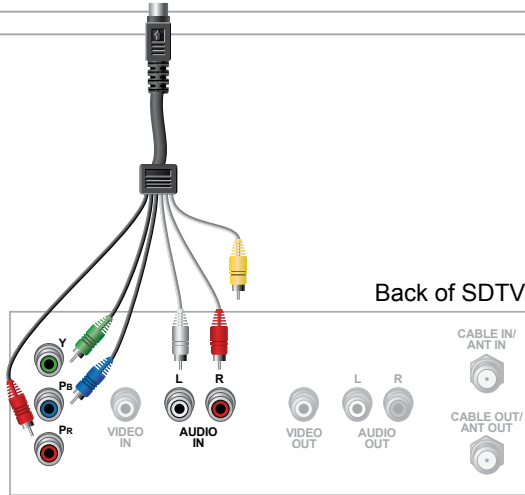

T116715

## Connecting to a Stereo VCR or DVD Recorder (optional)

The diagram below shows how to connect a recording device to your receiver. Although it is possible to watch TV using a connection through your VCR or DVD recorder to the TV, this connection may not provide the best picture, and HDTV users are restricted to an SD format. In addition, some content is copy protected and passing this content through the recording device may result in a picture that cannot be viewed.

For these reasons, the connection shown is best used to provide only video and audio to your recording device and not for normal TV viewing. The connection from the recording device to the TV (only used for playback of recorded material) depends on the type of device being used, the outputs that are supported, and the inputs that remain available for use on your TV.

Consult the owner's manuals provided with your TV and recording device for more details on connection options.

### Cables Used in this Configuration

- 1 Mini-DIN cable

**⚡ WARNING:** Electric shock hazard! Unplug all electronic devices before connecting or disconnecting any device cables to the set-top box.

Connecting your TV directly to the Audio/Video output of your set-top box will assure a more vivid picture and enhance your viewing enjoyment.

#### Back of Set-Top

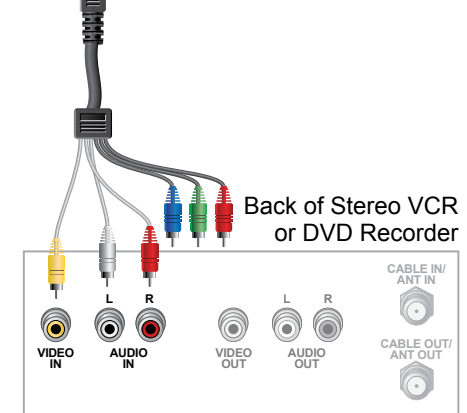
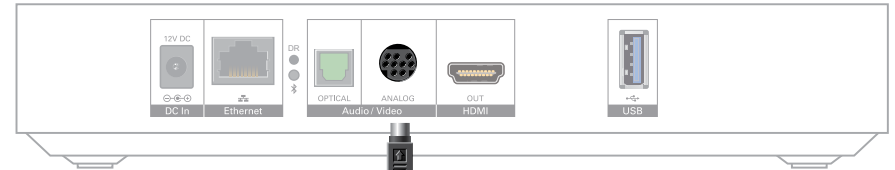

T116716

## Troubleshooting

If the set-top box does not perform as expected, the following tips may help. If you need further assistance, contact your service provider.

### No Picture

- Verify that the power to your TV is turned on
- If the set-top box is plugged into a wall switch, verify that the switch is in the ON position
- Verify that all cables are properly connected
- If your system includes a VCR, DVD recorder, or stereo, verify that you have properly connected the device to the set-top box
- Verify that you are using the proper input selection to the home theater set-top box or TV
- Verify that the set-top box is set to the proper screen type and resolution
- If you are using coaxial cable to connect to your TV, verify that the TV is tuned to the channel designated by your service provider (usually channel 3). Contact your service provider for the channel information

### No Color or Incorrect Color

- Verify that the current TV program is broadcast in color
- Adjust the TV color controls
- If you are using a component video connection (YPbPr), check that all connectors are completely and properly plugged into the set-top box and TV
- If you are using a component video connection (YPbPr) and your HDTV has only RGB or RGB-HV connectors, you must use an adapter. You can obtain the adapter through an electronic parts retailer

### No Sound

- If your setup includes a VCR, DVD recorder, or stereo, verify that you have properly connected the device to the set-top box
- Verify that the volume is turned up
- Verify that the mute function is not on
- Verify the proper input selection to the home theater set-top box or TV
- If you are using coaxial cable to connect to your TV, verify that the TV is tuned to the correct channel

## Frequently Asked Questions

### What Is Digital Television?

Digital television (DTV) is a huge leap forward in television technology compared to analog television that has been widely available since the 1940s. DTV is delivered and displayed using digital encoding, similar to the way a PC operates. By using digital technology, there is no variation in picture and sound quality from the origination point until it is displayed on your television. You always receive a high-quality picture without the wavy lines or static you might sometimes get from a weak analog signal. Another feature of digital television is digital surround sound using Dolby Digital technology, which is the same technology used to produce the sound you hear in movie theaters.

### What Is Standard-Definition Television?

Standard-definition television (SDTV) is a television system that uses a resolution that is not considered to be high-definition television (HDTV 720p, 1080i, and 1080p). The two common SDTV signal types are 576i, with 576 interlaced lines of resolution, derived from the European-developed PAL and SECAM systems; and 480i, with 480 interlaced lines of resolution, based on the American National Television System Committee (NTSC) system.

In North America, digital SDTV is broadcast in the same 4:3 aspect ratio as NTSC signals. In other parts of the world that used the PAL or SECAM color systems, standard-definition television is now usually shown with a 16:9 aspect ratio.

### What Is High-Definition Television?

High-Definition Television (HDTV) is a high-quality video standard developed to replace older video formats often referred to as SDTV (Standard-definition television). While HDTV's video quality is one of the most noticeable improvements over SDTV, HDTV includes a number of other important improvements as well.

First of all instead of an analog signal, used by traditional NTSC broadcasts, HDTV is always digital. This eliminates analog interference caused by electrical currents and magnetic fields. Secondly, HDTV uses a different aspect ratio than SDTV. While previous broadcasts used a 4:3 ratio, HDTV uses a ratio of 16:9. This wider aspect ratio more closely emulates how humans see the world, making the image appear more realistic. This ratio is also better for watching widescreen movies, which are recorded in widescreen for the same reason. HDTV signals are either 720p, 1080i or 1080p.

### Are Local TV Stations or Other Programmers Broadcasting in HDTV?

Many local TV stations and programmers are transmitting digital signals. However, transmitting a digital signal does not mean transmitting an HDTV signal. Some stations are using the new bandwidth to broadcast several standard-definition channels. Most stations and programmers, once they begin broadcasting in digital, are offering HD content from their parent network (for example, CBS, ABC, NBC, Fox, and PBS). Contact your service provider for more information.

### Why Aren't All of the Shows that I Watch in High-Definition?

A high-definition program must originate in HD format and be broadcast in HD format. Having an HDTV system does not mean that everything you watch will be viewed in high-definition. Getting the signal from a digital source also does not mean it is high-definition.

### What Is HDMI and Does it Support Dolby Digital 5.1 Audio?

The High-Definition Multimedia Interface (HDMI) is an uncompressed, all-digital audio/video interface. The Dolby Digital audio format that provides up to 5.1 separate channels of surround sound, and is the standard used for DVD-Video. HDMI supports standard, enhanced, or high-definition video, plus multi-channel digital audio, such as Dolby Digital audio, on a single cable.

## Picture Formats

### What Is the Difference Between a Standard-Screen and a Wide-Screen HDTV?

The type of screen your HDTV has (wide-screen or standard-screen) determines how the set-top box displays programs on the screen. The picture format for an HDTV is a combination of *aspect ratio* and *screen resolution* and is different for standard-screen and wide-screen HDTVs.

### What Is Aspect Ratio?

An aspect ratio is the ratio of the width to the height of the TV screen. The aspect ratios differ because the television industry manufactures both standard-screen and wide-screen HDTVs to appeal to consumer viewing preferences.

### What Is the Screen Resolution?

The screen resolution indicates the amount of detail that the picture displays. Resolution is identified by the number of display lines on the screen. The techniques that an HDTV uses to “paint” the picture on the screen are referred to as progressive and interlaced.

With the **progressive scanning** method, the lines are drawn on the screen one at a time in sequential order. Progressive scanning results in a more detailed image on the screen and is also less susceptible to the flicker commonly associated with interlaced scanning. The **interlaced method** involves refreshing pixels in alternation — first the odd lines and then the even lines.

For advanced setup, select the screen resolution that your TV can support. See your HDTV user manuals to choose the proper screen resolution (480i, 576i, 720p, 1080i, or 1080p) for your setup.

For example, a screen resolution of 1080i indicates that the screen shows 1080 lines in an interlaced display, and 720p indicates that the screens shows 720 lines in a progressive display.

A **standard-screen SDTV** has a 4x3 aspect ratio. The screen is 4 units wide for every 3 units tall.



A screen resolution of 480i or 516i fills the screen.

A **wide-screen HDTV** is one-third wider than a standard-screen HDTV. The screen is 16 units wide for every 9 units tall.

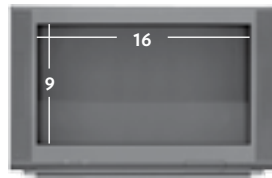

A screen resolution of 720p or 1080i fills the screen.

## Trademark and License Information

### Rovi Disclaimer

Technicolor will not be responsible for any licensing fees payable to Rovi Corporation, and Technicolor will not have any indemnification obligations relating to any claims asserted by Rovi Corporation, or by any entity controlled by, controlling, or under common control with Rovi Corporation (“Rovi Entities”), or any entity used to license intellectual property of the Rovi Entities, and the successors and assigns of the foregoing entities, including any claim related to electronic programming guides alone or in combination with any equipment provided by Technicolor.

### Dolby

Manufactured under license from Dolby Laboratories. Dolby, Dolby Audio and the double-D symbol are trademarks of Dolby Laboratories.

### HDMI

The terms HDMI and HDMI High-Definition Multimedia Interface, and the HDMI Logo are trademarks or registered trademarks of HDMI Licensing LLC in the United States and other countries.



TECHNICOLOR

1-5, rue Jeanne d'Arc  
92130 Issy-les-Moulineaux  
France

[www.technicolor.com](http://www.technicolor.com)

technicolor



Copyright 2016 Technicolor. All rights reserved.  
All tradenames referenced are service marks,  
trademarks, or registered trademarks of their respec-  
tive companies. Specifications subject to change  
without notice.  
DMS5-CTC-25-XXX v1.0

## SAFETY INSTRUCTIONS AND REGULATORY NOTICES

BEFORE YOU START INSTALLATION OF OR USE THIS PRODUCT, CAREFULLY READ THESE INSTRUCTIONS



*When using this product, always follow the basic safety precautions to reduce the risk of fire, electric shock and injury to persons, including the following:*

- Always install the product as described in the documentation that is included with your product.
- Avoid using this product during an electrical storm. There may be a remote risk of electric shock from lightning.
- Do not use this product to report a gas leak in the vicinity of the leak.

### Applicability

These Safety Instructions and Regulatory Notices apply to:

- Technicolor Set-Top Boxes

### Important Safety Instructions

- 1 Read these instructions.
- 2 Keep these instructions.
- 3 Heed all warnings.
- 4 Follow all instructions.
- 5 Do not use this apparatus near water.
- 6 Clean only with dry cloth.
- 7 Do not block any ventilation openings. Install in accordance with the manufacturer's instructions.
- 8 Do not install near any heat sources such as radiators, heat registers, stoves, or other apparatus (including amplifiers) that produce heat.
- 9 Do not defeat the safety purpose of the polarized or grounding-type plug. A polarized plug has two blades with one wider

than the other. A grounding-type plug has two blades and a third grounding prong. The wide blade or the third prong are provided for your safety. If the provided plug does not fit into your outlet, consult an electrician for replacement of the obsolete outlet.

- 10 Protect the power cord from being walked on or pinched particularly at plugs, convenience receptacles, and the point where they exit from the apparatus.
- 11 Only use attachments/accessories specified by the manufacturer.
- 12 Use only with the cart, stand, tripod, bracket, or table specified by the manufacturer, or sold with the apparatus. When a cart is used, use caution when moving the cart/apparatus combination to avoid injury from tip-over.
- 13 Unplug this apparatus during lightning storms or when unused for long periods of time.
- 14 Refer all servicing to qualified service personnel. Servicing is required when the apparatus has been damaged in any way, such as a power-supply cord or plug is damaged, liquid has been spilled or objects have fallen into the apparatus, the apparatus has been exposed to rain or moisture, does not operate normally, or has been dropped.



PAP



37542270

TECHNICOLOR

1-5 rue Jeanne d'Arc  
92130 Issy-les-Moulineaux  
France

[www.technicolor.com](http://www.technicolor.com)

Copyright 2016 Technicolor. All rights reserved.

All tradenames referenced are service marks, trademarks, or registered trademarks of their respective companies. Specifications subject to change without notice.









DMS5-SAF-25-581 v1.0.

technicolor



## Symbols

Following symbols may be found in this and accompanying documentation as well as on the product or accompanying accessories:

Symbol	Indication
	This symbol is intended to alert you that uninsulated voltage within this product may have sufficient magnitude to cause electric shock. Therefore, it is dangerous to make any kind of contact with any inside part of this product.
	This symbol is intended to alert you of the presence of important operating and maintenance (servicing) instructions in the documentation accompanying this product.
	This symbol indicates for indoor use only (IEC 60417-5957).
	This symbol indicates Double insulated Class II equipment (IEC 60417-5172). Does not require an earth connection.
	This symbol indicates Alternating Current (AC).
	This symbol indicates Direct Current (DC).
	This symbol indicates Electrical polarity.
	This symbol indicates Fuse.

## Directive

Unless express and prior approval by Technicolor in writing, you may not:

- Disassemble, de-compile, reverse engineer, trace or otherwise analyze the equipment, its content, operation, or functionality, or otherwise attempt to derive source code (or the underlying ideas, algorithms, structure or organization) from the equipment, or from any other information provided by Technicolor, except to the extent that this restriction is expressly prohibited by local law;
- Copy, rent, loan, re-sell, sub-license, or otherwise transfer or distribute the equipment to others;
- Modify, adapt or create a derivative work of the equipment;

- Remove from any copies of the equipment any product identification, copyright or other notices;
- Disseminate performance information or analysis (including, without limitation, benchmarks) from any source relating to the equipment.

Such acts not expressly approved by Technicolor will result in the loss of product warranty and may invalidate the user's authority to operate this equipment. Technicolor disclaims all responsibility in the event of use that does not comply with the present instructions.

## Open Source Software notification

This product may contain certain open source software modules which are subject to Open Source Software license terms. A list of the Open Source Software used by or provided under this product release and their corresponding Licenses and version number are available on Technicolor's website at the following address: [www.technicolor.com/en/hj/minisites/open-software](http://www.technicolor.com/en/hj/minisites/open-software) or at another address as Technicolor may provide from time to time.

If and where applicable, depending on the terms of the applicable Open Source Software licenses, the source codes of the Open Source Software are available for free on Technicolor's website at the following address: [www.technicolor.com/en/hj/minisites/open-software](http://www.technicolor.com/en/hj/minisites/open-software).

For avoidance of doubt, Open Source Software is only licensed by the original owner of the Open Source Software under the terms set forth in the designated Open Source License.

## Software and Firmware Use

The software described in this document is protected by copyright law and furnished to you under a license agreement. You may only use or copy this software in accordance with the terms of your license agreement.

The firmware in this equipment is protected by copyright law. You may only use the firmware in the equipment in which it is provided. Any reproduction or distribution of this firmware, or any portion of it, without express written consent from Technicolor is prohibited.

## Environmental information

### Energy efficiency

Energy savings - We have a role to play...



Technicolor is proud to offer you high-standard products with a variety of eco-friendly attributes. Next to carefully selected plastics and packaging to minimize our ecological footprint, our products benefit from a unique combination of hardware and software features that reduce energy consumption substantially.

The accompanying product documentation not only provides useful information on all the features of your product, but also on its energy consumption. We strongly encourage you to carefully read the product documentation before putting your equipment in service in order to get the best service it can offer you.

*By working together, we can reduce the impact we have on our earth!*

### Batteries (if applicable)



Batteries use some hazardous substances which pollute the environment. Do not dispose of them with other articles. Take care to dispose them at special collecting points.

Recycle or dispose of batteries in accordance with the battery manufacturer's instructions and local/national disposal and recycling regulations.

### Safety instructions



- *Read these instructions.*
- *Keep these instructions.*
- *Heed all warnings.*
- *Follow all instructions.*

### Climatic conditions

This product:

- Is intended for in-house stationary use; the maximum ambient temperature must not exceed 40 °C (104 °F); the relative humidity must be between 20 and 80 %.
- Must not be mounted in a location exposed to direct or excessive solar and/or heat radiation.
- Must not be exposed to heat trap conditions and must not be subjected to water or condensation.
- Must be installed in a Pollution Degree 2 environment (an environment where there is no pollution or only dry, non-conductive pollution).

If applicable, batteries (battery pack or batteries installed) must not be exposed to excessive heat such as sunshine, fire or the like.

### Ventilation and positioning

This equipment is intended to be used indoor in a residential or office environment.

- Remove all packaging material before applying power to the product.
- Place and use the product only in positions as described in the accompanying product documentation.
- Do not block or cover any ventilation openings; never stand it on soft furnishings or carpets.
- Never push objects through the openings in this product.
- Leave 7 to 10 cm (3 to 4 inches) around the product to ensure that proper ventilation gets to it.
- Do not install the product near any heat sources such as radiators, heat registers, stoves, or other apparatus (including amplifiers) that produce heat.
- Do not put anything on it which might spill or drip into it (for example, lighted candles or containers of liquids). Do not expose it to dripping or splashing, rain or moisture. If a liquid enters inside the product, or if the product has been exposed to rain or moisture, unplug it immediately and contact the Customer Service.

### Cleaning

Unplug this product from the wall socket and disconnect from all other devices before cleaning. Do not use liquid cleaners or aerosol cleaners. Use a damp cloth for cleaning.

### Water and moisture

Do not use this product near water, for example near a bathtub, washbowl, kitchen sink, laundry tub, in a wet basement or near a swimming pool. Transition of the product from a cold environment to a hot one may cause condensation on some of its internal parts. Allow it to dry by itself before re-starting the product.

### Electrical powering

The powering of the product must adhere to the power specifications indicated on the marking labels.

In case this product is powered by a power supply unit:

- This power supply unit must be Class II and a Limited Power Source in accordance with the requirements of IEC 60950-1/EN 60950-1.

Clause 2.5 and rated as indicated on the label on your product. It must be tested and approved to national, or local standards.

- **For US and Canada:** This product is intended to be supplied by a UL listed Direct Plug-in Power Unit marked "Class 2" and rated as indicated on the label on your product.

Only use the power supply unit that is supplied with this product. The use of other types of supplies is prohibited. If you are not sure of the type of power supply needed, consult the product's user documentation or contact your local product dealer.

#### Accessibility

The plug on the power supply cord or power supply unit serves as disconnect device. Be sure that the mains supply socket outlet you use is easily accessible and located as close to the product as possible.

The power connections to the product and the mains supply socket outlet socket must be accessible at all times, so that you always can disconnect the product quickly and safely from the mains supply.

#### Overloading

Do not overload mains supply socket outlets and extension power cords as this increases the risk of fire or electric shock.

#### Handling batteries

This product (or its remote control) may contain disposable batteries.



#### CAUTION

There is danger of explosion if the battery is mishandled or incorrectly replaced. Replace only with the same or equivalent type of battery. Do not disassemble it or attempt to recharge it outside the system. Do not crush, puncture, dispose of in fire, short the external contacts, or expose to water or other liquids.

- Insert batteries correctly. There may be a risk of explosion if the batteries are incorrectly inserted.
- Do not attempt to recharge 'disposable' or 'non-reusable' batteries.
- Please follow instructions provided for charging 'rechargeable' batteries.
- Replace batteries with the same or equivalent type.
- Do not expose batteries to excessive heat (such as sunlight or fire) and to temperatures above 100 °C (212 °F).

Coin/button cell batteries



#### CAUTION

**Do not ingest coin or button cell batteries!**  
**Chemical Burn Hazard**

This product or remote control supplied with this product may contain a coin/button cell battery. If the coin/button battery is swallowed, it can cause severe internal burns in just 2 hours and lead to death.

Keep new and used batteries away from children. If the battery compartment does not close securely, stop using the product and keep it away from children. If you think batteries might have been swallowed or placed inside any part of the body, seek immediate medical attention.

#### Cable Distribution

For this apparatus, the cable shield/screen shall be grounded (earthed) as close as practical to the point of entry of the cable into the building.

For products sold in the US and Canada, this reminder is provided to call the system installer's attention to ANSI/NFPA 70, the National Electrical Code (NEC), in particular Section 820.93, Grounding of Outer Conductive Shield of a Coaxial Cable (or Canadian Electrical Code Part 1).

#### Limiting the human body exposure to electromagnetic fields

This product should be installed and operated at least 20 cm (8 inches) or more away from a person's body.

#### Servicing

To reduce the risk of electric shock, do not disassemble this product. None of its internal parts are user-replaceable; therefore, there is no reason to access the interior. Opening or removing covers may expose you to dangerous voltages. Incorrect reassembly could cause electric shock if the appliance is subsequently used.

If service or repair work is required, take it to a qualified service dealer.

#### Damage requiring service

Unplug this product from the mains supply socket outlet and refer servicing to qualified service personnel under the following conditions:

- When the power supply, power cord or its plug are damaged.
- When the attached cords are damaged or frayed.
- If liquid has been spilled into the product.

- If the product has been exposed to rain or water.
- If the product does not operate normally.
- If the product has been dropped or damaged in any way.
- There are noticeable signs of overheating.
- If the product exhibits a distinct change in performance.

Immediately disconnect the product if you notice it giving off a smell of burning or smoke. Under no circumstances must you open the equipment yourself; you run the risk of electrocution.

#### **Protect the product when moving it**

Always disconnect the power source when moving the product or connecting or disconnecting cables.

#### **Interface classifications (upon applicability)**

The external interfaces of the product are classified as follows:

- Cable: TNV circuit, not subjected to overvoltages (TNV-1)
- MoCA, HPNA, RF: TNV circuit, not subjected to overvoltages (TNV-1)
- All other interface ports (e.g. HDMI, analog audio / video, Ethernet, USB,...), including the low voltage power input from the AC mains power supply: SELV circuits.

#### **Regulatory information**

You must install and use this device in strict accordance with the manufacturer's instructions as described in the user documentation that is included with your product.

Before you start installation or use of this product, carefully read the contents of this document for device specific constraints or rules that may apply in the country where you want to use this product. In some situations or environments, the use of wireless devices may be restricted by the proprietor of the building or responsible representatives of the organization.

If you are uncertain of the policy that applies on the use of wireless equipment in a specific organization or environment (e.g. airports), you are encouraged to ask for authorization to use this device prior to turning on the equipment. Technicolor is not responsible for any radio or television interference caused by unauthorized modification of the device, or the substitution or attachment of connecting cables and equipment other than specified by Technicolor. The correction of interference caused by such unauthorized modification, substitution or attachment will be the responsibility of the user.

Technicolor and its authorized resellers or distributors are not liable for any damage or violation of government regulations that may arise from failing to comply with these guidelines.

#### **North-America - Canada**

##### ***Notification of Canadian Radio Frequency Interference Statement***

This Class B digital apparatus complies with Canadian ICES-003.

This product meets the applicable Innovation, Science and Economic Development Canada technical specifications.

##### ***Canada - Industry Canada (IC)***

In case this product is equipped with a wireless transceiver, this device complies with Industry Canada's licence-exempt RSSs. Operation is subject to the following two conditions: (1) This device may not cause interference; and (2) This device must accept any interference, including interference that may cause undesired operation of the device.

##### ***Canada - Radiation exposure statement***

This equipment complies with IC radiation exposure limits set forth for an uncontrolled environment. This equipment should be installed and operated with minimum distance 20 cm (8 inches) between the radiator and your body.

##### ***Restricted frequency bands***

In case this product is equipped with a wireless transceiver operating in the 2.4 GHz band, it may only use channels 1 to 11 (2412 to 2462 MHz) on Canada territory.

In case this product is equipped with a wireless transceiver operating in the 5 GHz band, it is for indoor use only.

The availability of some specific channels and/or operational frequency bands are country dependent and are firmware programmed at the factory to match the intended destination. The firmware setting is not accessible by the end user.

#### **North-America - United States of America**

##### ***Important safety instructions***

- The cable distribution system should be grounded (earthed) in accordance with ANSI/NFPA 70, the National Electrical Code (NEC), in particular Section 820.93, Grounding of outer Conductive Shield of a Coaxial Cable.
- Leave 5 to 8 cm (2 to 3 inches) around the product to ensure proper ventilation to it.
- Never push objects through the openings in this product.

***Federal Communications Commission (FCC) radio frequency interference statement***



This equipment has been tested and found to comply with the limits for a Class B digital device, pursuant to Part 15 of the FCC Rules. These limits are designed to provide reasonable protection against harmful interference in a residential installation. This equipment generates, uses and can radiate radio frequency energy and, if not installed and used in accordance with the instructions, may cause harmful interference to radio communications. However, there is no guarantee that interference will not occur in a particular installation. If this equipment does cause harmful interference to radio or television reception, which can be determined by turning the equipment off and on, the user is encouraged to try to correct the interference by one or more of the following measures:

- Reorient or relocate the receiving antenna.
- Increase the separation between the equipment and receiver.
- Connect the equipment into an outlet on a circuit different from that to which the receiver is connected.
- Consult the dealer or an experienced radio/TV technician for help.



This device complies with Part 15 of the FCC Rules. Operation is subject to the following two conditions: (1) this device may not cause harmful interference, and (2) this device must accept any interference received, including interference that may cause undesired operation.

**FCC Caution:** Any changes or modifications not expressly approved by the party responsible for compliance could void the user's authority to operate this equipment.

Responsible Party: Technicolor, 101W, 103rd St., Indianapolis, IN 46290 USA, 317-587-5466.

**RF exposure statement**

This equipment complies with FCC radiation exposure limits set forth for an uncontrolled environment. End users must follow the specific operating instructions for satisfying RF exposure compliance. To maintain compliance with FCC RF exposure compliance requirements, please follow operation instruction as documented in the product documentation.

When the product is equipped with a wireless interface, then it becomes a mobile or fixed mounted modular transmitter and must have a separation distance of at least 20 cm (8 inches) between the antenna and the body of the user or nearby persons. In practice, this means that the user or nearby persons must have a distance of at

least 20 cm (8 inches) from the product and must not lean on the product in case it is wall-mounted. With a separation distance of 20 cm (8 inches) or more, the Maximum Permissible Exposure limits are well above the potential this wireless interface is capable to produce.

This transmitter must not be co-located or operating in conjunction with any other antenna or transmitter.

**Restricted frequency bands**

In case this product is equipped with a wireless transceiver operating in the 2.4 GHz band, it may only use channels 1 to 11 (2412 to 2462 MHz) on U.S.A. territory.

In case this product is equipped with a wireless transceiver operating in the 5 GHz band, it meets all the other requirements specified in Part 15E, Section 15.407 of the FCC Rules.

The availability of some specific channels and/or operational frequency bands are country dependent and are firmware programmed at the factory to match the intended destination. The firmware setting is not accessible by the end user.

Si le produit est équipé d'un émetteur-récepteur sans fil fonctionnant dans la bande des 2,4 GHz, il utilise uniquement les canaux 1 à 11 (2 412 à 2 462 MHz) sur le territoire canadien.

Si le produit est équipé d'un émetteur-récepteur sans fil fonctionnant dans la bande des 5 GHz, il peut uniquement être utilisé dans un environnement intérieur.

La disponibilité de certains canaux spécifiques et / ou bandes de fréquences de fonctionnement sont en fonction du pays et sont firmware programmé en usine pour correspondre à la destination prévue. Le réglage du firmware n'est pas accessible par l'utilisateur.

l'appareil ou des règles en vigueur dans le pays où vous comptez l'utiliser.

Dans certains environnements ou circonstances, l'emploi de dispositifs sans fil peut être prohibé par le propriétaire du bâtiment ou les représentants responsables de l'organisation concernée.

En cas de doute quant à la politique s'appliquant à l'utilisation d'équipements sans fil dans une organisation ou un environnement spécifique (par exemple dans les aéroports), il est recommandé de demander la permission d'utiliser l'appareil avant de l'allumer.

Technicolor n'est pas responsable des interférences avec les postes de radio ou de télévision susceptibles de survenir à la suite d'une modification non autorisée de l'appareil ou du remplacement ou de la connexion de câbles et d'équipements non agréés par Technicolor. C'est par conséquent à l'utilisateur qu'il incombe de remédier aux interférences causées par de telles manipulations.

Technicolor et ses revendeurs et distributeurs agréés déclinent toute responsabilité quant aux dommages ou violation des réglementations nationales découlant du non-respect de ces instructions.

## **Amérique du Nord – Canada**

### **Déclaration Canadienne d'Interférence de**

**Fréquence Radio**

Cet appareil numéroté de Classe B est conforme à la norme canadienne NMB-003.

Le présent produit est conforme aux spécifications techniques applicables

Économique Canada

### **Canada - Industrie Canada (IC)**

Si le produit est équipé d'un émetteur-récepteur sans fil, il est conforme aux CNR d'Industrie Canada applicables aux appareils radio exempts de licence. L'exploitation est autorisée aux deux conditions suivantes : (1) l'appareil ne doit pas produire de brouillage; (2) l'appareil doit accepter tout brouillage radioélectrique subi, même si le brouillage est susceptible d'en compromettre le fonctionnement.

**Canada - Avis radiation énoncées**  
Cet équipement est conforme avec les limites d'exposition aux radiations IC énoncées pour un environnement inconnu. Il doit être installé et opéré avec une distance minimale de 20 cm (8 pouces) entre la source de radiation et votre corps.

### **Bandes de fréquences restreintes**

il n'y a des lors pas de raison de l'ouvrir.

ne peut être remplacé par un non-professionnel; L'ouverture ou le retrait des couvercles peut vous exposer à des tensions dangereuses. Un remaniage incorrect peut entraîner un choc électrique lors de l'utilisation suivante.

Si votre appareil doit être réparé ou révisé, contactez un distributeur agréé. Détection nécessitant une intervention effectuée par la prise murale et faites effectuer la réparation par un service après-vente qualifié dans les cas suivants :

- Si l'alimentation ou sa fiche sont endommagées;
- Si un des câbles fournis est endommagé ou effiloché.
- Si le produit a été exposé à la pluie ou à de l'eau.
- Si le produit ne fonctionne pas normalement.
- Si le produit est tombé ou a été endommagé d'une façon quelconque.

- Si l'y a un signe perceptible de surchauffe.
- Si le produit présente des variations importantes au niveau des performances.
- Débrancher immédiatement le produit si vous remarquez qu'il y en a dégage une odeur de brûlé ou de la fumée. Vous ne devez en aucun cas ouvrir l'appareil vous-même car vous risquez d'être électrocuté.

**Protection du produit lors de son déplacement**  
Débrancher toujours le produit de sa source d'alimentation lorsque vous le déplacez ou lorsque vous branchez ou débranchez des câbles. Les interfaces externes du produit sont spécifiées comme suit :

- **Câble (câble) :** circuit TRT, non sujet à des surtensions (TRT-1)
- **MoCA, HPNA, RF :** circuit TRT, non sujet à des surtensions (TRT-1)
- **Tous les autres ports d'interface (par exemple, HDMI, audio / vidéo analogique, Ethernet, USB, etc.) y compris l'entrée d'alimentation :** basses tensions depuis l'alimentation du réseau : circuits TBT5

### **Avis réglementaire**

L'appareil doit être installé et utilisé en stricte conformité avec les instructions du fabricant; énoncées dans la documentation accompagnant le produit.

Avant d'installer ou d'utiliser le produit, lisez attentivement ce document afin de prendre connaissance des restrictions spécifiques à



**Alimentation électrique**  
L'alimentation du produit doit respecter les spécifications en matière d'alimentation figurant sur les étiquettes.  
Dans le cas où ce produit est alimenté par un bloc d'alimentation :  
• L'alimentation doit être de classe II, être une source à puissance limitée conformément aux exigences de la norme CECI 60950-1/EN 60950-1, classe 2,5, aux caractéristiques nominales comme indiquées sur l'étiquette fixée sur le produit. Elle doit être testée et répondre aux normes nationales ou locales.  
• **Pour l'Asie, l'Inde et le Canada** : Ce produit est destiné à être alimenté par une source «Classe 2» et considéré comme indiqué sur l'étiquette d'alimentation directe certifiée UL de «Classe 2» et considéré comme indiqué sur l'étiquette de votre produit.  
Utilisez uniquement le bloc d'alimentation livré avec votre produit. L'utilisation d'autres types de sources d'énergie est interdite. Si vous n'êtes pas certain du type d'alimentation nécessaire, veuillez consulter la documentation fournie avec le produit ou contacter votre revendeur local.  
**Accessibilité**  
L'alimentation électrique est un moyen de débrancher ce produit. Assurez-vous donc que le socle de la prise dans laquelle vous branchez le cordon d'alimentation est facilement accessible. Les connexions sur l'alimentation au produit et la prise d'alimentation doit être accessible à tout moment, de sorte que vous pouvez toujours débrancher le produit rapidement et en toute sécurité de l'alimentation.  
**Surcharge**  
Ne surchargez pas les prises du réseau d'alimentation ni les allonges car ceci augmente les risques d'incendie et de choc électrique.  
**Manipulation des piles**  
Ce produit (ou sa télécommande) peuvent contenir des piles jetables.  
**AVERTISSEMENT**  
Il existe un risque d'explosion si les piles ne sont pas correctement manipulées ou remplacées. Ne remplacez les piles que par des piles de même type. Ne démontez pas et ne tentez pas de recharger les piles hors du système. N'échangez pas les piles, ne les percez pas, ne les jetez pas au feu, ne court-circuitez pas les contacts externes et ne les exposez pas à l'eau ou à d'autres matières liquides.

• Insérez les piles correctement. Il existe un risque d'explosion si les piles ne sont pas insérées correctement.  
• N'essayez pas de recharger des piles «jetables» ou «non rechargeables».  
• Veuillez suivre les instructions fournies concernant la charge de piles «rechargeables». Remplacez les piles uniquement par des piles identiques ou équivalentes.  
• N'exposez pas les piles à une chaleur excessive (à la chaleur du soleil ou au feu, par exemple) et des températures supérieures à 100 °C (212 °F).  
Piles bouton

**AVERTISSEMENT**  
**Ne pas ingérer la pile!**  
**Danger de brûlure chimique**  
Ce produit, ou la télécommande fournie avec ce produit contient une pile bouton. Si la pile bouton est avalée, elle peut provoquer de graves brûlures internes en 2 heures seulement et peut entraîner la mort.  
Conserver les piles neuves et usées hors des portées des enfants. Si le compartiment pile ne se ferme pas correctement, cesser d'utiliser le produit et venir hors de portée des enfants.  
En cas de doute concernant le fait que les piles pourraient avoir été avalées ou introduites dans une partie quelconque du corps, consultez immédiatement un médecin.

**Distribution par câble**  
Le blindage du câble coaxial de cet appareil doit être relié à la terre le plus possible du point d'entrée du câble dans le bâtiment.  
En ce qui concerne les produits vendus au Canada, ce rappel vise à attirer l'attention de l'installateur du système sur ANSII/NFPA 70, National Electrical Code (NEC), en particulier l'article 820.93 (ou Code canadien de l'électrification partie 1), qui fournissent les instructions pour une mise à la terre correcte de la protection du câble coaxial.

**Limiter l'exposition du corps humain aux champs électromagnétiques**  
Ce produit doit être installé et opéré avec une distance minimale de 20 cm (8 pouces) entre la source de radiation et votre corps.

**Entretien**  
Pour réduire les risques de choc électrique, ne démontez pas ce produit. Aucune de ses pièces internes



**AVERTISSEMENT**  
Il existe un risque d'explosion si les piles ne sont pas correctement manipulées ou remplacées. Ne remplacez les piles que par des piles de même type. Ne démontez pas et ne tentez pas de recharger les piles hors du système. N'échangez pas les piles, ne les percez pas, ne les jetez pas au feu, ne court-circuitez pas les contacts externes et ne les exposez pas à l'eau ou à d'autres matières liquides.



- Doit être installé dans un environnement présentant un degré de pollution 2 (environnement exempt de pollution ou avec Le cas échéant, les piles (pack de piles ou piles installées) ne doivent pas être exposées à une chaleur excessive comme le soleil, un feu ou similaire.
- Cet équipement est destiné à être utilisé à l'intérieur dans un environnement résidentiel ou bureau.
- Retirez l'intégralité de l'emballage avant de brancher le produit.
- Placez et utilisez le produit uniquement dans des positions comme décrit dans la documentation du produit
- d'accompagnement
- Ne jamais se tenir sur des tissus d ameublement et les tapis.
- Ne jamais pousser des objets dans les ouvertures de ce produit.
- Laissez 7 à 10 cm (3 à 4 pouces) autour du produit afin d'assurer une bonne ventilation.
- Ne pas installer le produit à proximité de sources de chaleur telles que des radiateurs, poeles ou autres appareils (y compris les amplificateurs) qui produisent de la chaleur.
- Ne mettez rien sur lui qui pourrait renverser ou goutte à goutte dans le (par exemple, des bougies ou des contenants de liquides éclaboussures, de la pluie ou de l'humidité. Si le produit a été exposé à la pluie ou à l'humidité, débranchez-le immédiatement et contactez le service après-vente.
- Nettoyage
- Débranchez le produit de la prise murale et se déconnecter de tous les autres appareils avant de nettoyer. N'utilisez pas de détergents liquides ou d'aérosols. Nettoyez-le avec un chiffon humide.
- Eau et humidité
- N'utilisez pas ce produit à proximité d'une arrivée d'eau, par exemple près d'une baignoire, d'un lavabo.
- Ne doit pas être installé dans un endroit exposé à un rayonnement direct et excessif du soleil et/ou à des radiations de chaleur.
- Ne doit pas être mis dans des conditions d'accumulation de chaleur et ne doit pas être soumis à l'humidité ou la condensation.
- Laissez l'appareil sécher avant de le remettre en marche.

- Economies d'énergie – Vous avez un rôle à jouer... Technicolor est fier de vous offrir des produits de haute-standard avec une efficacité énergétique
- Eco
- La documentation du produit qui accompagne non seulement fournit des informations utiles sur toutes les caractéristiques de votre produit, mais aussi sur sa consommation d'énergie. Nous vous encourageons fortement à lire attentivement la documentation du produit avant de mettre votre matériel en service afin d'obtenir le meilleur service qu'il peut vous offrir.
- Ensemble, nous pouvons réduire l'impact de nos activités sur la planète
- Batteries (le cas échéant)
- Les batteries utilisent des substances dangereuses qui polluent l'environnement. Ne les jetez pas avec d'autres articles. Prenez soin de les déposer aux points de collecte spéciaux.
- Recyclez ou mettez au rebut les piles conformément aux instructions de leur fabricant et/ou aux réglementations locales en la matière.
- Consignes de sécurité
- Lisez ces instructions.
- Conservez ces instructions.
- Respectez tous les avertissements.
- Suivez toutes les instructions.
- Ce produit :
  - Est conçu pour une utilisation fixe dans un bureau à une température ambiante maximale de 40 °C (104 °F); l'humidité relative doit être comprise entre 20 et 80 %.
  - Ne doit pas être installé dans un endroit exposé à un rayonnement direct et excessif du soleil et/ou à des radiations de chaleur.
  - Ne doit pas être mis dans des conditions d'accumulation de chaleur et ne doit pas être soumis à l'humidité ou la condensation.
- Conditions climatiques
- Ce produit :
  - Est conçu pour une utilisation fixe dans un bureau à une température ambiante maximale de 40 °C (104 °F); l'humidité relative doit être comprise entre 20 et 80 %.
  - Ne doit pas être installé dans un endroit exposé à un rayonnement direct et excessif du soleil et/ou à des radiations de chaleur.
  - Ne doit pas être mis dans des conditions d'accumulation de chaleur et ne doit pas être soumis à l'humidité ou la condensation.



que sur le produit ou les accessoires d'accompagnement :

- aux performances de l'appareil (y compris et sans restriction, les tests de performance) quelle que soit la source d'information. Ces actes, réalisés sans l'accord explicite de Technicolor, entraînent la perte de la garantie du produit et enlèvent à l'utilisateur le droit d'employer l'équipement. Technicolor rejette toute responsabilité en cas d'utilisation de l'équipement non conforme aux présentes instructions.
- diffuser des informations ou analyses relatives aux performances de l'appareil (y compris et sans restriction, les tests de performance) quelle que soit la source d'information. Ces actes, réalisés sans l'accord explicite de Technicolor, entraînent la perte de la garantie du produit et enlèvent à l'utilisateur le droit d'employer l'équipement. Technicolor rejette toute responsabilité en cas d'utilisation de l'équipement non conforme aux présentes instructions.
- **Notice relative aux Logiciels Libres**  
Ce produit logiciel peut contenir des éléments (modules ou bibliothèques logicielles) publiés sous licence « Logiciels libres » (« open source »). Ces composants logiciels peuvent être modifiés dans les prochaines versions logicielles.  
Vous trouverez la liste des logiciels libres embarqués dans ce produit logiciel, ainsi que leur licence et version sur le site Technicolor à l'adresse suivante : [www.technicolor.com/en/hi/minisites/opensource](http://www.technicolor.com/en/hi/minisites/opensource), ou à toute autre adresse URL que Technicolor pourrait fournir dans le futur.  
En fonction des termes et conditions d'utilisation applicables à ces éléments logiciels (les licences de logiciel libre en cause), le code source de ces modules ou bibliothèques logicielles seront mis à disposition sur le site de Technicolor, à l'adresse suivante : [www.technicolor.com/en/hi/minisites/opensource](http://www.technicolor.com/en/hi/minisites/opensource), ou à toute autre adresse URL que Technicolor pourrait fournir dans le futur.  
En tout état de cause, les logiciels libres sont licenciés directement par l'auteur original de ces composants logiciels, dans les termes de la licence de logiciel libre correspondante.
- **Utilisation du logiciel et du micrologiciel**  
Le logiciel décrit dans ce document est fourni par la loi sur les droits d'auteur et vous est fourni dans le cadre d'un contrat de licence. Vous pouvez utiliser ou copier ce logiciel en respectant les modalités de votre contrat de licence. Le micrologiciel de cet équipement est protégé par la loi sur la protection des droits d'auteur. Il ne peut être utilisé qu'avec l'équipement dans lequel il est fourni. Toute reproduction ou distribution de l'ensemble d'un produit ou de ce micrologiciel sans autorisation écrite explicite de Technicolor est interdite.
- **Consignes à respecter**  
Ce symbole indique que vous ne pouvez pas :  
  - démonter, décomposer, examiner l'appareil, son contenu, son fonctionnement ou ses fonctionnalités, ni tenter de copier le code source (ou les concepts sous-jacents, les algorithmes, la structure ou l'organisation) de l'appareil, ni de toute autre information fournie par Technicolor, sauf si cette restriction est expressément interdite par la législation locale ;
  - copier, louer, prêter, revendre, mettre sous licence, ni transférer ou distribuer l'appareil à des tiers ;
  - modifier, adapter ou créer un dérivé de l'appareil ;
  - retirer de l'appareil l'identification du produit ;
  - restreindre ou toute autre notification ;

Indication	Symbol
• Ce symbole a pour but d'avertir toute personne qui un contact avec une pièce interne de ce produit, sous tension et non isolée, pourrait être suffisants pour provoquer un choc électrique. Il est donc dangereux d'être en contact avec toute pièce interne de ce produit.	
• Ce symbole a pour but de prévenir sur le fonctionnement et l'entretien accompagné ce produit.	
• Ce symbole indique pour une utilisation en intérieur (IEC 60417-5957).	
• Ce symbole indique équipement de classe II double isolé (IEC 60417-5172). Nécessite pas une connexion de terre.	
• Ce symbole indique le courant alternatif (AC).	
• Ce symbole indique le courant direct (DC).	
• Ce symbole indique la polarité électrique.	
• Ce symbole indique un fusible.	

# RÈGLEMENTAIRES CONSIGNES DE SÉCURITÉ ET INFORMATIONS

AVANT D'INSTALLER OU D'UTILISER LE  
PRODUIT, LISEZ ATTENTIVEMENT CES  
INSTRUCTIONS



**Afin d'éviter tout risque d'incendie, de choc électrique et de blessure corporelle, il convient d'utiliser le produit conformément aux mesures de sécurité de base, parmi lesquelles les suivantes :**

- Respectez toujours les instructions d'installation détaillées dans la documentation accompagnant le produit.
- Évitez de connecter ou d'utiliser ce produit en cas d'orage. La foudre peut provoquer une faible risque de choc électrique.
- N'utilisez pas le produit pour signaler une fuite de gaz à proximité de cette fuite.

## Applicabilité

Ces Consignes de sécurité et informations

- Technicolor Decoders (Set-Top Box)

## Instructions Importantes Relatives à la

### Sécurité

- 1 Lisez ces instructions.
- 2 Conservez ces instructions.
- 3 Soyez attentif à tous les avertissements.
- 4 Suivez toutes les instructions.
- 5 N'utilisez pas cet appareil à proximité de points d'eau.
- 6 Nettoyez cet appareil avec un chiffon sec uniquement.
- 7 Veillez à ne pas obstruer les orifices de ventilation, installez cet appareil conformément aux instructions du fabricant.
- 8 N'installez pas l'appareil à proximité d'une source de chaleur telle qu'un radiateur, une grille de chauffage, un poêle ou tout autre dispositif produisant de la chaleur (y compris un amplificateur).
- 9 Ne retirez pas le dispositif de sécurité de la

## Symboles

Les symboles suivants peuvent être trouvés dans ce et la documentation d'accompagnement, ainsi

- 1 La maintenance doit être réalisée par des techniciens qualifiés. Des opérations de maintenance sont nécessaires lorsque l'appareil a été endommagé (par exemple, en cas de dégâts au niveau du cordon d'alimentation ou de la prise), lorsque du liquide s'est répandu ou que des objets sont tombés à l'intérieur de l'appareil, lorsqu'il a été exposé à la pluie ou à l'humidité et en cas de dysfonctionnement ou de chute.
- 2 Ébranchez cet appareil pendant les orages ou en cas d'inutilisation prolongée.
- 3 Utilisez uniquement l'appareil avec le chariot, le support, le trépied, la console ou la table recommandés par le fabricant ou vendus avec l'appareil. Si vous utilisez le chariot, veillez à déplacer l'appareil avec précaution, afin de ne pas faire basculer le chargement et risquer de vous blesser.
- 4 Utilisez exclusivement les accessoires recommandés par le fabricant.
- 5 Utilisez de manière sûre le produit. Évitez de marcher sur le cordon d'alimentation ou de le pincer, en particulier au niveau des prises de courant, des socles de prises de courant et du point de sortie de l'appareil.
- 6 Consultez un électricien pour remplacer cette dernière.
- 7 Utilisez une broche de terre, est destinée à garantir votre sécurité. Si la prise fournie n'est pas adaptée à votre prise de courant, consultez toujours les instructions d'installation détaillées dans la documentation accompagnant le produit.
- 8 Utilisez de manière sûre le produit. Évitez de marcher sur le cordon d'alimentation ou de le pincer, en particulier au niveau des prises de courant, des socles de prises de courant et du point de sortie de l'appareil.
- 9 Utilisez de manière sûre le produit. Évitez de marcher sur le cordon d'alimentation ou de le pincer, en particulier au niveau des prises de courant, des socles de prises de courant et du point de sortie de l'appareil.
- 10 Utilisez de manière sûre le produit. Évitez de marcher sur le cordon d'alimentation ou de le pincer, en particulier au niveau des prises de courant, des socles de prises de courant et du point de sortie de l'appareil.
- 11 Utilisez de manière sûre le produit. Évitez de marcher sur le cordon d'alimentation ou de le pincer, en particulier au niveau des prises de courant, des socles de prises de courant et du point de sortie de l'appareil.
- 12 Utilisez uniquement l'appareil avec le chariot, le support, le trépied, la console ou la table recommandés par le fabricant ou vendus avec l'appareil. Si vous utilisez le chariot, veillez à déplacer l'appareil avec précaution, afin de ne pas faire basculer le chargement et risquer de vous blesser.
- 13 Ébranchez cet appareil pendant les orages ou en cas d'inutilisation prolongée.
- 14 La maintenance doit être réalisée par des techniciens qualifiés. Des opérations de maintenance sont nécessaires lorsque l'appareil a été endommagé (par exemple, en cas de dégâts au niveau du cordon d'alimentation ou de la prise), lorsque du liquide s'est répandu ou que des objets sont tombés à l'intérieur de l'appareil, lorsqu'il a été exposé à la pluie ou à l'humidité et en cas de dysfonctionnement ou de chute.



TECHNICOLOR  
1-5 Jeanne d'Arc  
92130 Issy-les-Moulineaux  
France  
www.technicolor.com  
Copyright 2016 Technicolor. Tutti i diritti riservati.  
Tutti i nomi commerciali citati sono marchi o marchi registrati della  
rispettiva società. Specifiche soggette a modifica senza preavviso.  
DM55-SAF-25-181 v1.0