

Quick Installation Guide

Nuclias Connect AX3600 Access Point

DAP-X2850



Contents

English

1

Before You Begin

This installation guide provides instructions for installing the DAP-X2850 on your network. Additional documentation is also available on the D-Link support website.

- **Nuclias Connect Manual:** For additional information and instructions on how to configure the device using Nuclias Connect.
- **DAP-X2850 User Manual:** For additional information and instructions on how to configure the device using the web user interface.

Package Contents

This DAP-X2850 package includes the following items:

- DAP-X2850 Access Point
- Power Adapter (Optional)
- Mounting Plate and Hardware
- Quick Start Guide

If any of the above items are damaged or missing, please contact your local D-Link reseller.

Note: Using a power supply with a different voltage than the one recommended for the device will cause damage and void the warranty for this product.

Note: No power adapter is supplied with this product. To power the unit, use an 802.3at PoE Switch or an 802.3at PoE Injector.

System Requirements

- Computers with Windows®, Macintosh®, or Linux-based operating systems with an installed Ethernet Adapter
- Internet Explorer 11, Safari 7, Firefox 28, or Google Chrome 33 and above (for configuration)

Hardware Overview

LED Indicators

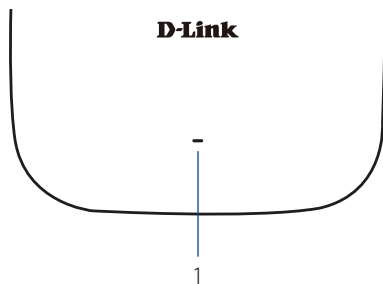

Figure 1: Front Panel LED

#	LED	Description
1	Power/Status	Green (Solid) - Device operational Red (Flashing) - Device booting up/Device malfunctioned Red (Solid) - Device boot up has failed

Table 1: LED Description

Interface Connectors

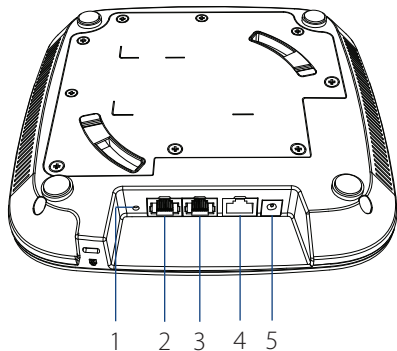

Figure 2: Rear Connectors

#	Connector	Description
1	Reset	Press and hold for 15 seconds to factory reset the device.
	Console Port	RJ45 console port for connection to a management computer.
	LAN Port	10/100/1000 Mbps Ethernet LAN port (non-PoE).
4	LAN (PoE) Port	2.5 Gbps Ethernet port for data and Power over Ethernet (PoE) power.
5	Power Input	Input for the power adapter; however, the device can also be powered over Ethernet. Note: An 802.3at PoE injector is not included in the package contents, but can be purchased separately.

Table 2: Interface Description

Installation

The DAP-X2850 can be powered using one of the following two methods:

Using Power over Ethernet (PoE)

1. Use a standard Ethernet cable to connect the LAN port on the DAP-X2850 to a PoE power source device such as an 802.3at PoE switch or 802.3at PoE injector.

Using a Power Adapter (Optional)

1. Connect the power connector of the adapter to the power input on the DAP-X2850 and plug the adapter into a nearby power outlet.

Configuration

Using Nuclias Connect

The DAP-X2850 is designed to be managed through Nuclias Connect. Refer to the **Nuclias Connect Manual** for detailed configuration instructions.

Manual Configuration

Note: D-Link recommends manually configuring the device before mounting it. The management computer, DHCP server and DAP-X2850 must be in the same subnet.

Use one of the following methods to access the web user interface:

Connecting through Ethernet

1. Use an Ethernet cable to connect the DAP-X2850 to the management computer, or to the switch or router the management computer is connected to.
2. Manage the access point from a computer. Enter **dapx2850.local** in the address field of your browser.

- Log in to the administration user interface. The default login information is

Username: **admin**
Password: **admin**

Connecting Wirelessly

- Connect the management computer to the default SSID of the DAP-X2850, "dlink".
- Manage the access point from a computer. Enter **dapx2850.local** in the address field of your browser.
- Log in to the administration user interface. The default login information is

Username: **admin**
Password: **admin**

Mounting

Mounting on a Solid Wall or Ceiling

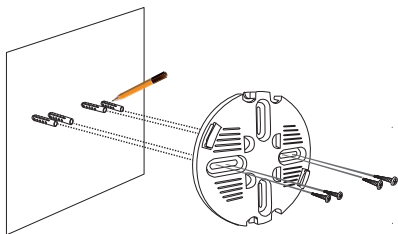

Figure 3: Attaching the Mounting Plate

- Use the mounting plate to mark the location where to drill the holes in the wall or ceiling.
- Drill holes on the markings and place the included anchors into the drilled holes.
- Align and place the mounting plate on top of the anchors and use the included screws to secure the mounting plate to the surface.

- Plug the Ethernet cable into the LAN (PoE) port of the device. **Note:** If you are powering the device with a power adapter, plug the adapter into the Power Input port.

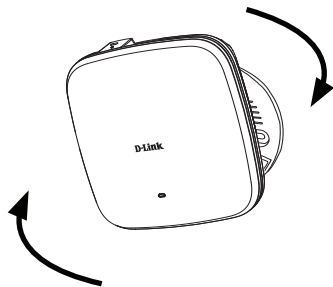

Figure 4: Mounting the Device

- Rotate the DAP-X2850 into the grooves on the mounting plate to secure it to the plate.

Mounting with Ceiling Brackets

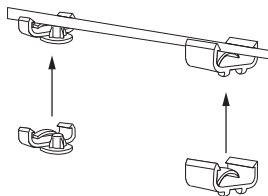

Figure 5: Attaching the Ceiling Brackets

- Clip the two ceiling brackets onto a ceiling crossbar.

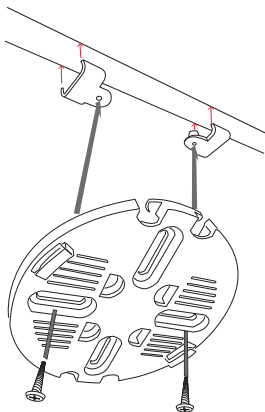

Figure 6: Attaching the Mounting Plate

2. Use the included screws to secure the mounting plate to the ceiling brackets.
3. Plug the Ethernet cable into the LAN (PoE) port of the device. **Note:** If you are powering the device with a power adapter, plug the adapter into the Power Input port.

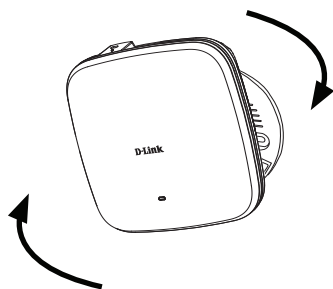

Figure 7: Mounting the Device

4. Rotate the DAP-X2850 into the grooves on the mounting plate to secure it to the plate.

Appendix - Statements

ErP Power Usage

This device is an Energy Related Product (ErP) that automatically switches to a power-saving Network Standby mode within 1 minute of no packets being transmitted. It can also be turned off through a power switch to save energy when it is not needed.

Network Standby: 5.065 watts

Federal Communication Commission Interference Statement

This equipment has been tested and found to comply with the limits for a Class B digital device, pursuant to Part 15 of the FCC Rules. These limits are designed to provide reasonable protection against harmful interference in a residential installation. This equipment generates, uses and can radiate radio frequency energy and, if not installed and used in accordance with the instructions, may cause harmful interference to radio communications. However, there is no guarantee that interference will not occur in a particular installation. If this equipment does cause harmful interference to radio or television reception, which can be determined by turning the equipment off and on, the user is encouraged to try to correct the interference by one of the following measures:

- Reorient or relocate the receiving antenna.
- Increase the separation between the equipment and receiver.
- Connect the equipment into an outlet on a circuit different from that to which the receiver is connected.
- Consult the dealer or an experienced radio/TV technician for help.

Non-modifications Statement:

Any changes or modifications not expressly approved by the party responsible for compliance could void the user's authority to operate this equipment.

Caution:

This device complies with Part 15 of the FCC Rules. Operation is subject to the following two conditions:

- (1) This device may not cause harmful interference, and (2) this device must accept any interference received, including interference that may cause undesired operation.

This device and its antenna(s) must not be co-located or operating in conjunction with any other antenna or transmitter except in accordance with FCC multi-transmitter product procedures. For product available in the USA/Canada market, only channel 1~11 can be operated. Selection of other channels is not possible.

Note

The country code selection is for non-USA models only and is not available to all USA models. Per FCC regulations, all WiFi product marketed in the USA must be fixed to USA operational channels only.

Operations in the 5.15-5.25GHz band are restricted to indoor usage only.

Radiation Exposure Statement:

This equipment complies with FCC radiation exposure limits set forth for an uncontrolled environment. This equipment should be installed and operated with minimum distance 42cm between the radiator & your body.

NCC警語:

取得審驗證明之低功率射頻器材，非經核准，公司、商號或使用者均不得擅自變更頻率、加大功率或變更原設計之特性及功能。

低功率射頻器材之使用不得影響飛航安全及干擾合法通信；經發現有干擾現象時，應立即停用，並改善至無干擾時方得繼續使用。前述合法通信，指依電信管理法規定作業之無線電通信。低功率射頻器材須忍受合法通信或工業、科學及醫療用電波輻射性電機設備之干擾。

使用此產品時應避免影響附近雷達系統之操作。

D-Link[®]
Building Networks for People



Ver. 1.00(WW)_130x183
2020/05/14