

# D-Link

## DCS-1000W 2.4GHz Wireless Internet Camera Manual

### **FCC Warning**

This device complies with Part 15 of the FCC Rules. Operation is subject to the following two conditions:

(1) this device may not cause harmful interference, and (2) this device must accept any interference received, including interference that may cause undesired operation.

### **CAUTION:**

Changes or modifications not expressly approved by the party responsible for compliance could void the user's authority to operate the equipment.

FCC RF exposure requirements: The antenna(s) used for this transmitter must be installed to provide a separation distance of at least 20 cm from all persons and must not be co-located or operating in conjunction with any other antenna or transmitter.

# Contents

---

<b>CONTENTS .....</b>	<b>1</b>
<b>ABOUT THIS GUIDE.....</b>	<b>3</b>
<b>INTRODUCTION.....</b>	<b>3</b>
<b>SYSTEM REQUIREMENT .....</b>	<b>3</b>
<b>FEATURES AND BENEFITS .....</b>	<b>4</b>
<b>PHYSICAL DESCRIPTION.....</b>	<b>6</b>
FRONT PANEL.....	6
REAR PANEL.....	7
BOTTOM PANEL.....	8
<b>UNPACKING THE DCS-1000W.....</b>	<b>9</b>
<b>HARDWARE INSTALLATION.....</b>	<b>9</b>
CONNECTING THE DCS-1000W TO THE CAMERA STAND.....	10
<b>SECURITY.....</b>	<b>11</b>
<b>SOFTWARE INSTALLATION.....</b>	<b>12</b>
WEB CONFIGURATION.....	12
MAIN MENU IMAGE.....	13
SYSTEM ADMINISTRATION.....	13
SYSTEM ADMINISTRATION.....	14
<i>System Administration – System.....</i>	<i>14</i>
<i>System Administration - Image.....</i>	<i>21</i>
<i>System Administration - Users.....</i>	<i>23</i>
<i>System Administration – DateTime .....</i>	<i>24</i>
<i>System Administration – Trigger.....</i>	<i>26</i>
<i>System Administration - Information.....</i>	<i>28</i>
<i>System Administration - Information.....</i>	<i>28</i>
<i>System Administration - Tools .....</i>	<i>28</i>
VIEW IMAGE – ACTIVE X MODE.....	29
VIEW IMAGE – JAVA MODE.....	31
<b>IPVIEW APPLICATION INSTALLATION .....</b>	<b>32</b>
INSTALLATION.....	32
<b>IPVIEW – GETTING STARTED.....</b>	<b>38</b>
IPVIEW .....	38
HOW TO CHANGE PASSWORD.....	39
<i>Change Password.....</i>	<i>39</i>

HOW TO CHANGE IP ADDRESS.....	40
<i>Change IP Address</i> .....	40
HOW TO ADD A CAMERA.....	42
<i>Add Camera</i> .....	42
HOW TO DELETE A CAMERA.....	45
<i>Delete Camera</i> .....	45
HOW TO VIEW A CAMERA.....	46
<i>View Camera</i> .....	46
HOW TO TAKE A SNAP-SHOT OF A CAMERA.....	47
<i>Snap shot Camera</i> .....	47
HOW TO ADJUST THE PROPERTY SETTING.....	47
<i>Property Setting</i> .....	47
<i>Menu Bar</i> .....	54
<i>Menu Bar - File</i> .....	54
<i>Menu Bar – View</i> .....	55
<i>Columns</i> .....	55
<i>Viewing Format</i> .....	55
<i>List View</i> .....	56
<i>Menu Bar - Camera</i> .....	57
<i>Enable Function</i> .....	57
<i>Menu Bar - Tools</i> .....	57
<i>Menu Bar - Help</i> .....	57
IPVIEW ICON DESCRIPTION .....	58
CONTEXT SENSITIVE MENU.....	59
<b>UNINSTALL IPVIEW APPLICATION.....</b>	<b>60</b>
<b>APPENDIX.....</b>	<b>62</b>
FREQUENTLY ASKED QUESTIONS.....	62
TROUBLE SHOOTING.....	63
HOW TO PING YOUR IP ADDRESS.....	66
I/O CONNECTOR.....	67
UPGRADE FIRMWARE.....	69
TIME ZONE TABLE.....	70
XPLUG CONTROL INSTALLATION.....	72
<i>Installation to a Local PC</i> .....	73
ADJUSTING THE CAMERAS FOCUS.....	75
REPLACING THE LENS.....	77
<b>SPECIFICATIONS .....</b>	<b>78</b>
<b>TECHNICAL SUPPORT .....</b>	<b>80</b>
<b>REGISTRATION.....</b>	<b>80</b>

# About This Manual

---

This manual describes the DCS-1000W, including a description of its features, as well as installation procedures and web configuration instructions. Included are the operating procedures for the IPView Remote Monitoring Application.

## Introduction

---

The DCS-1000W connects directly to an Ethernet, Fast Ethernet, or 802.11b Network. It is different from the conventional PC Camera because the DCS-1000W is a standalone system with a built-in CPU and web server providing a low cost solution that can transmit high quality video images for monitoring. The DCS-1000W can be accessed remotely, and controlled from any PC/Notebook over the Intranet or Internet via a web browser. The simple installation procedures and web-based interface offers easy integration to your network application environments coupled with many applications such as remote monitoring for a cost-effective solution.

## System Requirement

---

**Local Area Network:** 10Base-T Ethernet or 100Base TX Fast Ethernet

**Wireless Local Area Network:** IEEE 802.11b Wireless LAN

**Recommended:** PC or Notebook to Access the Wireless Internet Camera

### Web Configuration:

- Java Enabled and Compliant Web Browser
- CPU: Pentium II, 266 MHz or above
- Memory Size: 32 MB (64 MB recommended)
- VGA card resolution: 800x600 or above

## **IPView Configuration:**

- Windows XP, Me, 2000, 98Se or 98
- Pentium II, 350 MHz or above
- Memory Size of 128 MB (256 MB recommended)
- VGA card resolution of 800x600 or above

## **Features and Benefits**

---

This section describes the features and benefits of DCS-1000W

### **Simple to Use**

DCS-1000W is a standalone system with built-in CPU requiring no special hardware or software such as PC frame grabber cards. DCS-1000W supports both ActiveX mode for Internet Explorer and Java mode for Internet Explorer and Netscape Navigator. Therefore, all that is required is a computer with a web browser software such as Internet Explorer 4.0 or above or Netscape 4.0 or above. Just plug and view the picture from your DCS-1000W with a valid IP Address.

### **Supports a Variety of Platforms**

Supporting TCP/IP networking, SMTP e-mail, HTTP and other Internet related protocols. The DCS-1000W can be utilized in a mixed operating system environment such as Windows, Unix, and Macintosh. It can also be integrated easily into other Internet/Intranet applications because of its standards based features.

### **Wired and Wireless Network Support**

The DCS-1000W supports both wired and wireless transmission providing the advantage of mobility, flexibility and high-speed of wireless LAN based technology, IEEE 802.11b, to transform DCS-1000W into a total solution for your network. There are three modes available configured from the slide switch on the rear panel.

- LAN (Local Area Network Only)
- LAN/WLAN (Local Area Network and Wireless Local Area Network. Both can be accessed at the same time.)
- WLAN (Wireless Local Area Network Only)

## **Web Configuration**

Applying a standard web browser, administrators can configure and manage the DCS-1000W directly from its own web page via the Intranet or Internet. Up to 64 users name and password are permitted with privilege setting controlled by the administrator.

## **Remote Monitoring Utility**

Powerful IPView application assigns administrator with a pre-defined user ID and password whom can modify DCS-1000W settings from the remote site via Intranet or Internet. When new firmware is available you can also upgrade remotely over the network for added convenience. Users are also allowed to monitor the image, record the image to hard drive, and take snapshots.

## **Connection to External Devices**

Supporting auxiliary Input/Output connectors, you can connect the DCS-1000W to a variety of external devices such as IR-sensors, switches and alarm relays. One can combine with programmable alarming facilities to develop a variety of security applications that are triggered on alarm-based events. The DCS-1000W provides up to two in/out external devices for connectivity.

## **Broad Range of Applications**

With today's high-speed Internet services, the DCS-1000W can provide the ideal solution for live video images over the Intranet and Internet for remote monitoring. DCS-1000W allows remote access from a web browser for live image viewing and allows the administrator to manage and control the DCS-1000W anywhere and any time in the world. Apply DCS-1000W to monitor various objects and places such as homes, offices, banks, hospitals, child-care centers, amusement parks and other varieties of industrial and public monitoring. The DCS-1000W can also be used for intruder detection, capture still images and video images for archiving and many more applications.

# Physical Description

---

This section describes the externally visible features of DCS-1000W.

## Front Panel

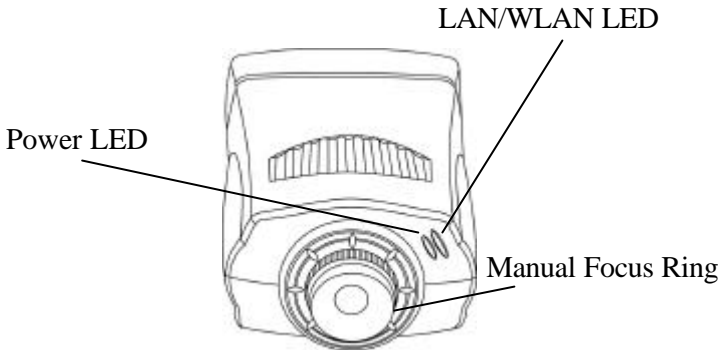

### Power LED

The Power LED is positioned on the right side of DCS-1000W's lens while facing the DCS-1000W. Steady blue confirms DCS-1000W is powered on.

#### Note:

There are three settings for the Power LED to control the light illumination for monitoring purpose from Normal / Off / Dummy. *Please refer to the Web Configuration section for detailed information and usage.*

### LAN/WLAN LED

The LAN/WLAN LED is positioned on the right side of DCS-1000W's lens while facing the DCS-1000W. It is located right of the Power LED

Steady orange confirms good connection to the LAN or WLAN.

Dependent on the data traffic the LED will begin to flash to indicate that DCS-1000W is receiving/transceiving from/to the LAN or WLAN network.

#### Note:

There are three settings for the LAN/WLAN LED to control the light illumination for monitoring purpose from Normal / Off / Dummy. Please refer to the Web Configuration section for detailed information and usage.

# Rear Panel

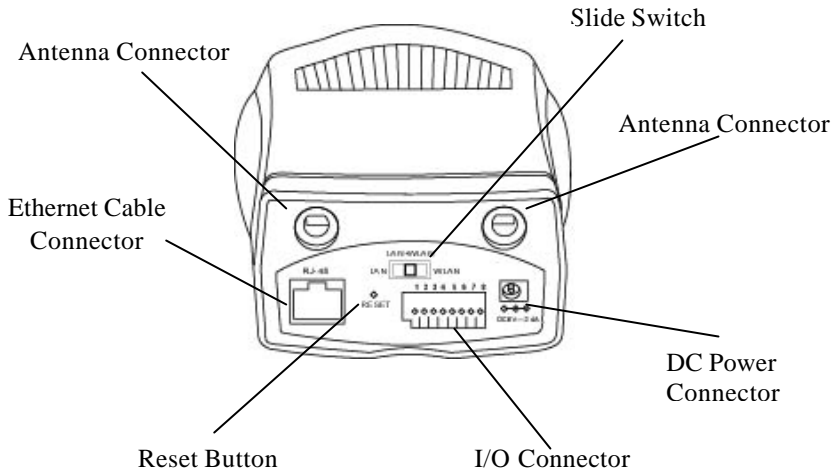

## Network Cable Connector

The DCS-1000W's rear panel features an RJ-45 connector for connections to 10Base-T Ethernet cabling or 100Base-TX Fast Ethernet cabling (which should be Category 5 twisted-pair cable). The port supports the NWay protocol, allowing DCS-1000W to automatically detect or negotiate the transmission speed of the network.

## DC Power Connector

The DC power input connector is located on the DCS-1000W's rear panel and is labeled **DC 5V** with a single jack socket to supply power to DCS-1000W.

## Reset Button

Reset will be initiated when the reset button is pressed once and Power LED begins to flash.

Factory Reset will be initiated when the reset button is pressed continuously for three seconds or when Power LED begins to light up. Release the reset button and the Power LED will begin to flash indicating that the DCS-1000W's settings are reverting back to the factory settings. When factory reset is completed DCS-1000W will be set to default on channel 11 and EES-ID is set as "NULL String" (This default setting will let DCS-1000W connect to ANY access point on the infrastructure network). The IP address will also return to the default setting as 192.168.0.20.



## Slide Switch

The slide switch permit user' s to determine the type of network communication media for the DCS-1000W and is positioned on the rear panel. The three settings are as follows:

- LAN (Local Area Network Only)
- LAN/WLAN (Local Area Network and Wireless Local Area Network. Both can be accessed at the same time.)
- WLAN (Wireless Local Area Network Only)

## I/O Connector

There are four I/O connectors, two for input and two for output situated on the rear panel. The I/O connectors provide the physical interface to send and receive digital signals to a variety of external alarm devices. *Please refer to the User's Guide appendix for detailed information.*

## Antenna Connector

There are two SMA type antenna connectors located at the rear panel of the DCS-1000W providing connection for two high sensitivity antenna included with the device.

## Bottom Panel

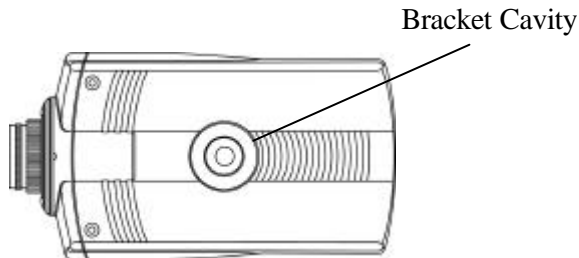

## Bracket Cavity

Located on the bottom panel of DCS-1000W the bracket cavity is used to connect the camera stand onto DCS-1000W by attaching the screw head on the camera stand into the mounting cavity of DCS-1000W.

# Unpacking the DCS-1000W

Carefully remove all items from the package. In addition to this User's Guide, be certain that you have:

- One Wireless Internet Camera
- Two External Wireless Antennas
- One Installation CD-ROM
- One AC power adapter
- One Camera Stand
- One Category 5 Ethernet Cable
- This manual

If any item is missing, or if you find any damage or mismatch, promptly contact your dealer for assistance.

## Hardware Installation

This section describes the Hardware installation procedure for DCS-1000W.

### 1. Attach Wireless Antenna

From the rear panel of DCS-1000W screw the 2 external antennas that came with DCS-1000W into the antenna connector.

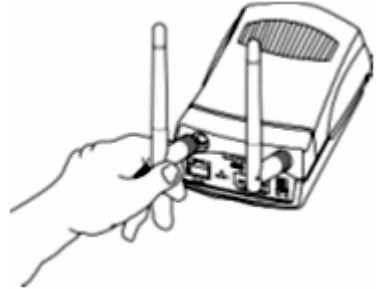

### 2. Configure Network Communication

From the rear panel of DCS-1000W select the desired network communication for DCS-1000W from the Slide Switch. Position the Slide Switch to the setting required either LAN or LAN/WLAN position.



*Please refer to the Physical Description section for detailed information.*

### 3. Connect an Ethernet cable

Connect an Ethernet cable to the network cable connector located on DCS-1000W's rear panel and attach it to the network.

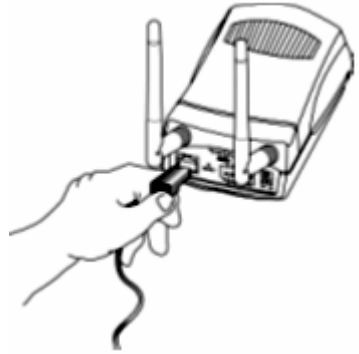

### 4. Attach the external power supply

Attach the external power supply to the DC power input connector located on DCS-1000W's rear panel and is labeled DC 5V and connect it to your local power supply.



**Note:**

Confirm power source is supplied from the LED indicators label Power on DCS-1000W is illuminated.

## Connecting the DCS-1000W to the Camera Stand

DCS-1000W comes with a camera stand with a swivel ball screw head that can be attached to DCS-1000W's bottom bracket cavity. Attach the camera stand to DCS-1000W and station it for your application. There are three holes located in the base of the camera stand allowing the DCS-1000W to be mounted on the ceiling or any wall securely.

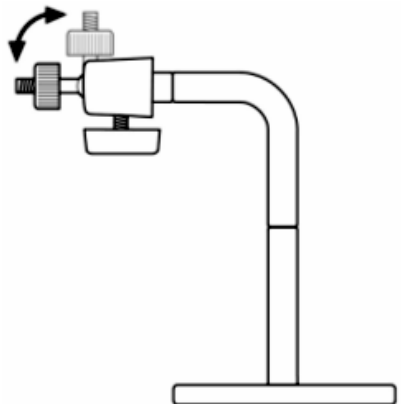

# Security

---

To ensure the highest security and prevent unauthorized usage of DCS-1000W the Administrator has the exclusive privilege to access System Administration setting to allow users the security level of entry and authorize privileges for all users. The DCS-1000W supports multi-level password protection/access to the DCS-1000W that can be restricted to defined users who has a "User Name" and "User Password" which is assigned by the Administrator.

The administrator can release a public user name and password so when remote users access DCS-1000W they will have the right to view the image transmitted by DCS-1000W.

**Note:**

When the DCS-1000W is used for the first time it is highly recommended that the Administrator set the "Admin ID" and "Admin Password" to constrain user access to the DCS-1000W since the Default settings are Null String (no password). Once the ID and Password are defined only the Administrator has the access to management DCS-1000W. This procedure should be done as soon as possible since the security features with DCS-1000W will not be enabled until the "Admin ID" and "Admin Password" is defined.

# Software Installation

---

This section describes the Software installation procedure of the DCS-1000W for Web Configuration and the IPView application.

## Web Configuration

- DCS-1000W must be configured through its built-in Web-based Configuration.

From the web browser, enter the default IP address (192.168.0.20) to access the Welcome screen of the DCS-1000W. To configure your DCS-1000W type “**http://192.168.0.20**” in the address box of your favorite Web Browser. The number is the default IP address of your DCS-1000W. Press **Enter**.

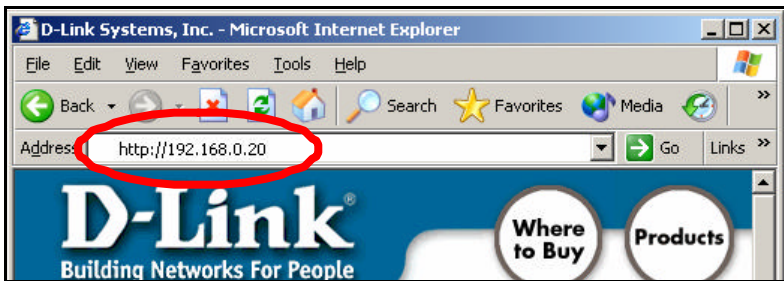

### Note:

The PC's IP address must correspond with the DCS-1000W's IP address in the same segment (i.e. PC=192.168.0.5, Camera=192.168.0.20) for the two devices to communicate. For instructions on how to do this, please access instructions for installing any of the D-Link Broadband Gateway products from [support.dlink.com/products](http://support.dlink.com/products). The DI-713 or DI-714 are good products to use as an example as their Quick Install Guides are the most up-to-date.

## Main Menu Image

After the default IP address is entered from the browser DCS-1000W Home screen will appear with a still image. There will be three options to choose from to set-up and view your DCS-1000W and they are as follows:

- View Image – ActiveX Mode
- View Image – Java Mode
- System Administration

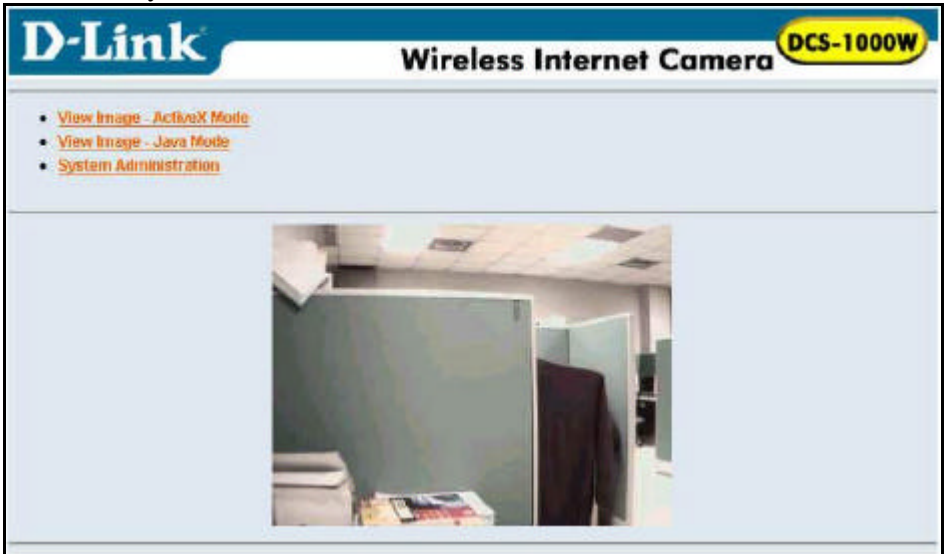

## System Administration

Click on “**System Administration**” from the Home screen to access the settings required for DCS-1000W.

There will be several options in the System menu bar to choose from to set your DCS-1000W and they are as follows:

- System
- Image
- Users
- Date/Time
- Trigger
- Information
- Tools

# System Administration

## System Administration – System

The System menu contains commands for settings that are required for inputting key details to set-up the DCS-1000W for operation.

Click on **"System"** in the system administration menu bar and the System screen will appear as illustrated below:

The screenshot shows the 'System' configuration page for a D-Link Wireless Internet Camera (DCS-1000W). The page has a blue header with the D-Link logo and the camera model. Below the header is a navigation bar with tabs: System, Setup, Home, Date/Time, Images, Information, Tools, and Home. The 'Home' tab is circled in red. A callout box points to it with the text 'Click on "Home" to return to Home Screen'. The main content area is divided into sections: General Name (DCS-06EBS1), Location, Admin (Admin ID, Admin Password, Confirm Password), IP Assignment (Manually Assign with IP Address, Subnet Mask, Default Gateway; or Assign Automatically Using RARP, BOOTP, DHCP, PPPoE with Service Name, User ID, Password), DNS IP Address (1, 2), Wireless Interface (Connection Mode: Infrastructure, 802.11 Ad-hoc, Ad-hoc; Network Name (ESS-ID), Wireless Channel, Encryption WEP Key, Confirm WEP Key), LED Control (Normal, OFF, Dimming), Leading Address From, and Open Second Port (Yes, No) with Web Server and Transfer Image settings. At the bottom are Save and Cancel buttons.

## Camera Name:

This field is used for entering a descriptive name for the device.

The default setting for the Camera Name is CS-xxxxxx, where xxxxxx is the last six digit of the MAC Address. The maximum length is 32 (Printable ASCII).

## Location:

This field is used for entering a descriptive name for the location used by DCS-1000W.

## Admin:

This field is used for entering the Administrator ID along with the password to access the System Administration settings. Be sure to enter the password twice to confirm the details once in the Admin Password field and again in the Confirm Password field.

The default setting for Admin is blank (Null String) you need to key in the Admin ID with a maximum length of 12 (Printable ASCII) characters and enter the Admin Password with a maximum length of 8 (Printable ASCII) characters.

It is highly recommended to set the Admin ID and Admin Password as soon as possible to ensure the highest possible security.

## IP Assignment:

### Important Information

Access to DCS-1000W is done through assigning a proper IP address. Please make sure to use a vacant IP address when you assign the IP address for DCS-1000W. This will prevent errors from occurring if the IP address is overlapped.

There are two options to select from the IP Assignment either **Manually Assign** or **Assign Automatically Using**.

## Manually Assign

You can click “**Manually Assign**” and directly enter the IP address.



The default settings are as follows:

- Default IP – 192.168.0.20
- Subnet Mask – 255.255.255.0
- Default Gateway – 0.0.0.0

## Assign Automatically Using

### Important Information

It is recommended that you do not use an Automatically Assigned IP address as it may be difficult to determine the IP address of the unit after the IP address has been assigned. It is recommended that an IP address be assigned manually.

If your network is using RARP, BOOTP or DHCP server you can click “**Assign Automatically Using**” and click on “**RARP**”, “**BOOTP**” or “**DHCP**”. Under this setting DCS-1000W will automatically assign an IP address from RARP, BOOTP or DHCP server. Each time the DCS-1000W starts up be sure the RARP, BOOTP or DHCP server is setup as assign a static IP to your DCS-1000W.

If your application requires a direct connection from an ADSL modem through the DCS-1000W’s RJ-45 LAN port and you also have an ISP PPPoE account, click on the “**PPPoE**” option and enter the Service Name, User ID and Password into the respective fields.

The DCS-1000W will get an IP address from the ISP each time DCS-1000W starts up when Assign Automatically is used.

### DNS IP Address:

DNS (Domain Name System) server is an Internet service that translates domain names (ie. www.dlink.com) into IP addresses (ie. 192.168.0.20). The DNS IP address can be received from your ISP. Enter at least one DNS IP Address.

### Wireless Interface:

#### **Connection Mode:**

Use the Connection Mode to determine the type of wireless communication for the DCS-1000W. There are three choices of **Infrastructure mode**, **802.11 Adhoc mode** and **Adhoc mode**. The default setting for the Connection Mode is Infrastructure.

**Note:**

Keep in mind that after setting the Wireless Interface make sure that the Slide Switch on the rear panel is positioned to either LAN/WLAN or WLAN setting for the wireless communication to take effect.

**Network Name:**

This field is used to setup which wireless network (ESS-ID Extended Service Set ID) DCS-1000W is to be connected for communication. The ESS-ID is a unique identifier shared among all points in a wireless network environment.

The default Network Name is blank space (NULL String); this default setting will let the DCS-1000W connect to any access point under the infrastructure network mode.

To connect the DCS-1000W to a specific access point on the network make sure that you set the ESS-ID of the DCS-1000W to correspond with the access point's ESS-ID. Type any string up to 32 characters long (spaces, symbols, and punctuation are not allowed) in the Network Name box.

To connect the DCS-1000W to an Ad-hoc wireless workgroup make sure that you set the same wireless channel and ESS-ID to match with the PC/Notebook wireless channel and ESS-ID for direct wireless communication under the Ad-hoc wireless workgroup (ad-hoc and 802.11 ad-hoc modes).

**Note:**

The DCS-1000W supports two ad-hoc modes (802.11 ad-hoc mode and proprietary ad-hoc mode). Which option of the ad-hoc mode required depends on the operation of your DCS-1000W. It depends on which ad-hoc mode is supported by your wireless card driver on the PC/Notebook. Some driver supports both modes, however, some driver support only one of the modes. The names of each ad-hoc mode may not be consistent between each wireless card vendor therefore you may need to try each of the ad-hoc mode (802.11 mode and proprietary mode) and select the mode that can communicate with each other.

**Wireless Channel:**

The pull down menu provides the wireless channel for communication. A "channel" is a range of frequencies to be used in communication between DCS-1000W and Access Point in infrastructure mode or DCS-1000W and PC/Notebook in Ad-hoc mode. Select the appropriate channel from the list

provided depending on the regulatory region which the unit is sold. The default setting is channel 11.

### **Encryption WEP Key:**

Wireless network communications are easily intercepted. WEP (Wired Equivalent Privacy) is an encryption method specified by the IEEE 802.11b standard to make any intercepted communications extremely difficult to interpret by unauthorized parties.

To enable WEP Encryption, first decide which WEP key format will be applied. Click on ASCII or HEX check box to select input format as ASCII format or HEX format, and then input the WEP key. To Confirm the WEP key you must enter the data once again in the Confirm WEP Key field.

### **ASCII input format:**

ASCII format causes each character you type to be interpreted as an eight-bit value. All unaccented upper- and lower-case Western European characters that can be input through your keyboard's typing zone are valid. To setup 64-bit WEP key, input 5 ASCII characters, for example, '12345'. To setup 128-bit WEP key, input 13 ASCII characters, for example, '1234567890123'. These character counts result in bit counts of 40 and 104, respectively; the DCS-1000W will automatically pad your input to a bit count of 64 or 128.

### **HEX input format:**

Hex format causes each pair of characters you type to be interpreted as an eight-bit value in hexadecimal (base 16) notation. Only the digits 0 through 9 and the letters A through F (in upper or lower case) are valid. To setup 64-bit WEP key, input 10 HEX format, for example, '3132333435', this is the same with ASCII input '12345'. To setup 128-bit WEP key, input 26 HEX format, for example, '31323334353637383930313233', this is the same with ASCII input '1234567890123'. These character counts result in bit counts of 40 and 104, respectively; the DCS-1000W will automatically pad your input to a bit count of 64 or 128.

On the Confirm WEP Key field, input the same characters as the Encryption Code field.

Make sure the Encryption Code is the same with the access point's encryption code that DCS-1000W is to be connected under Infrastructure mode. Your PC/Notebook's encryption code also needs to be setup the same with the

DCS-1000W's encryption code under either Infrastructure mode or Ad-hoc mode.

The default setting for the Encryption Key is “Disable”. Therefore, to secure the wireless transmission be sure to Enable the Encryption Key by entering the relevant data.

**Note:**

Carefully input the Encryption Code, any error setting the code will cause the communication link to fail.

**LED Control:**

The LED control allows you to setup the LED illumination as desired. This feature provides the flexibility when surveillance activity is ON.

There are three options as follows:

- Normal  
**Power** - Steady On of the LED indicator.  
**LAN/WLAN** - Steady On of the LED indicator. When LAN/WLAN activity is present the LED indicator will flash steadily.
- OFF  
**Power** - LED indicator is off  
**LAN/WLAN** – LED indicator is off
- Dummy  
**Power** - Steady On of the LED indicator.  
**LAN/WLAN** - Steady On of the LED indicator with random flashing.

The default setting for the LED control is “Normal”. When you have configured the LED control the correct illumination will set in after 1 minute.

**Note:**

This function is built-in to the LED indicators to add extra capabilities. The three options allow the Administrator to configure and camouflage the illumination for the LED indicator to falsify the monitoring status. In Normal Mode the LED indicator functions normally. Under Off Mode the LED indicators are both off, however, it is still monitoring the activity. In Dummy Mode the LED indicators operate in monitoring condition but monitoring activity is off or on.

### **Loading ActiveX From:**

This field is used to specify the location of Xplug Control (ActiveX) plug-in program. Enter the information as required in .ocx format, for example: <http://www.<your company>.com/xplug.ocx> where <your company> must be replaced with your company's DNS server.

Instructions for installing ActiveX from the driver CD is included in this manual. Refer to the section labeled "Software Installation".

### **Open Second Port:**

The Web Server field allows settings to open a second port for the DCS-1000W. This will permit users of IP Sharing Gateways to support multiple DCS-1000Ws. By default Port 80 is always opened for DCS-1000W Web Server access. Select **"Yes"** and input the second port value.

For example: If you have 5 Internet Cameras to be installed, each with an IP address from

192.168.0.101  
192.168.0.102  
192.168.0.103  
192.168.0.104  
192.168.0.105

You can open the second port for each Internet Camera from port 81 to Port 85 as illustrated below:

DCS-1000W 1 – IP 192.168.0.101, second web port 81  
DCS-1000W 2 – IP 192.168.0.102, second web port 82  
DCS-1000W 3 – IP 192.168.0.103, second web port 83  
DCS-1000W 4 – IP 192.168.0.104, second web port 84  
DCS-1000W 5 – IP 192.168.0.105, second web port 85

You also need to setup your DSL gateway for Port Mapping.

Port 81 map to 192.168.0.101  
Port 82 map to 192.168.0.102  
Port 83 map to 192.168.0.103  
Port 84 map to 192.168.0.104  
Port 85 map to 192.168.0.105

The Transfer Image field allows settings to open a second port for the DCS-1000W to transfer images. The default Port “8481” is open image transfer and you can define a second port similar to above.

### Save/Cancel:

After making sure all settings in the System are correct, click on the “Save” icon to store the settings in the DCS-1000W. You can alternatively click on the “Cancel” icon to restore all settings to the values last saved to or retrieved from the DCS-1000W.

## System Administration - Image

Image menu in the system administration contains commands to provide the settings for the images captured by DCS-1000W.

Click on “Image” in the system administration menu bar and the Image screen will appear as illustrated below:

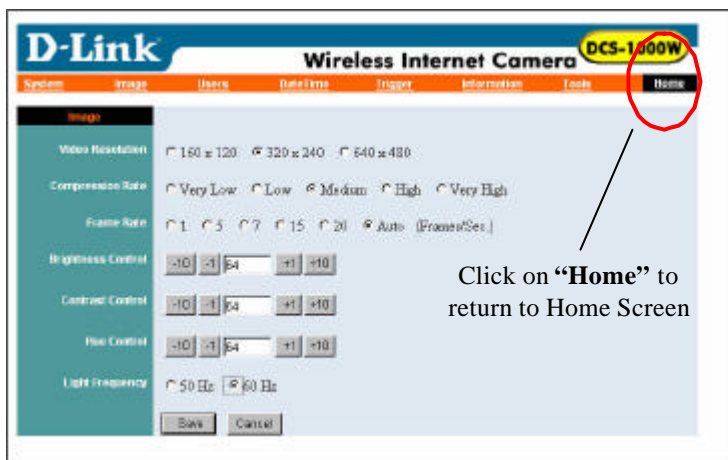

### Video Resolution:

Select the desired video resolution format ranging from 160x112, 320x240 (default) or 640x480

### Compression Rate:

Select the desired compression rate with five levels from very low to very high. Higher video compression rate will generate more compact file size with less video quality and vice-versa. The default setting is “Medium”.

**Frame Rate:**

Select the frame rate desired with default setting at Auto for optimal frame rate. A setting of “Auto” will get best results.

**Brightness Control:**

Adjust the brightness level with default setting of 64.

**Contrast Control:**

Adjust the contrast level with default setting of 64.

**Hue Control:**

Adjust the hue level with default setting of 64.

**Light Frequency:**

Adjust the light frequency to suit your area of operation from the options either 50 Hz or 60 Hz (default).

50 Hz and 60 Hz variants are available to accommodate the different light frequency found in USA (60 Hz) and Europe (50 Hz) for the DCS-1000W to ensure better image quality.

**Save/Cancel:**

After making sure all settings in the System are correct, click on the “**Save**” icon to store the settings in the DCS-1000W. You can alternatively click on the “**Cancel**” icon to restore all settings to the values last saved to or retrieved from the DCS-1000W.

## System Administration - Users

The User options menu contains commands to allow system administrator to assign legal users who are permitted to monitor the DCS-1000W from a remote site.

Click on “Users” in the system administration menu bar and the Users screen will appear as illustrated below:

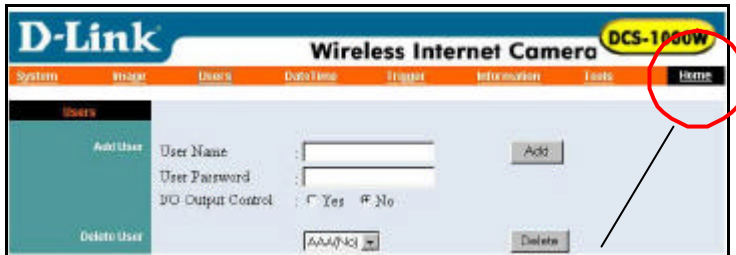

Click on “Home” to return to Home Screen

### Add User:

#### **User Name:**

Enter the user name in this field.

A maximum of 64 users names are allowed, however each users name must be different. Each user name can be used as a group given the password for example, if the User Name is “Guest” and the User Password is “Guest” anyone can access the DCS-1000W with these details used as a group of users under the User Name “Guest”. The maximum length for the User Name is 12 characters (Printable ASCII).

#### **User Password:**

Enter the user’s password you want to assign to the specific user-name. The maximum password length is 8 characters (Printable ASCII).

#### **I/O Output Control:**

The Administrator has the authority to give permission to control the I/O Output Control to users by selecting “Yes” or “No” to activate the I/O Output control.

To add a new user name input the necessary information first and click on the “Add” icon.



## Delete User:

Select the user you wish to delete from the pull down menu and click on the “delete” icon.

### Important Information

Once administrator has configured DCS-1000W Users, any user will be required to enter a login password to access the video image from DCS-1000W. The password dialog box is illustrated below.



## System Administration – DateTime

The DateTime menu contains commands for setting the DCS-1000W's time and date requirements to provide correct information to users who might be thousands of miles away in the remote site. There are two options to select from the DateTime menu bar, either Synchronized with Time Server or Set Manually.

Click on “DateTime” in the system administration menu bar and the DateTime screen will appear as illustrated below:

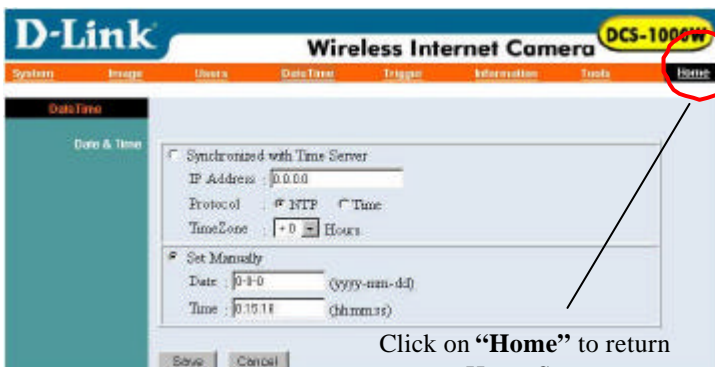

Click on “Home” to return to Home Screen

**DateTime:**

Select **“Synchronized with Time Server”** and the time will be based on GMT setting. The time will be synchronized every 10 minutes. This is also the default setting for DCS-1000W.

**IP Address:**

Enter the IP Address of the Time Server in this field.

**Protocol:**

Two options of NTP or Time are available for your selection to link with the Time Server. The default setting is NTP.

**TimeZone:**

System administrator must select the time zone for the region. *Please refer to the appendix for the time zone selection table.*

To set the Date Time manually select **“Set Manually”**. The system administrator must then enter the Date and Time in the respective field manually.

When you select **“Set Manually”**, each time the DCS-1000W is powered off and on you must re-enter the details once again due to time lost.

**Note:**

Please find below NTP server web address for your reference to set the time server.

<http://www.eecis.udel.edu/~mills/ntp/clock1.htm>

<http://www.eecis.udel.edu/~mills/ntp/clock2.htm>

**Save/Cancel:**

After making sure all settings in the System are correct, click on the **“Save”** icon to store the settings in the DCS-1000W. You can alternatively click on the **“Cancel”** icon to restore all settings to the values last saved to or retrieved from the DCS-1000W.

## System Administration – Trigger

The Trigger menu contains commands for the I/O Trigger connectors providing the physical interface for 2 digital outputs and 2 digital inputs that are used for connecting a diversity of external alarm devices to the DCS-1000W such as IR-Sensor and alarm relay devices.

Click on **“Trigger”** in the system administration menu bar and the Trigger screen will appear as illustrated below:

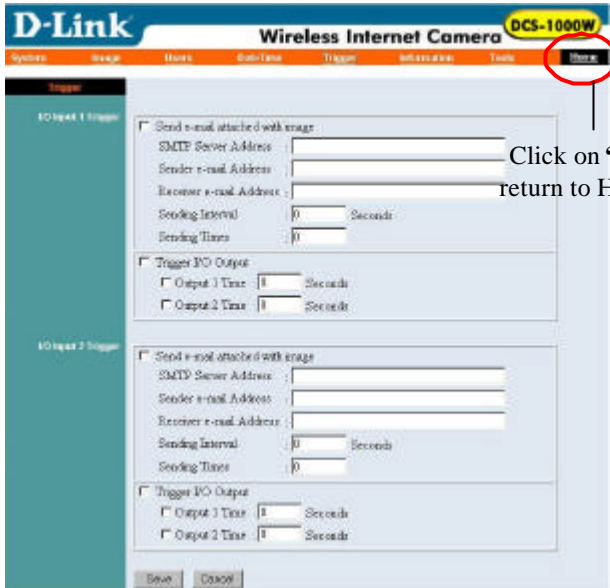

Click on **“Home”** to return to Home Screen

The default setting for the I/O Trigger functions is “disabled” You must enable the I/O Trigger first before the Triggers will perform.

There are two options to select from the Trigger screen **I/O Input 1 Trigger** and **I/O Input 2 Trigger**.

### I/O Input 1 Trigger:

Select **“Send e-mail attached with image”** and enter the relevant information such as the SMTP Server Address, Sender e-mail Address, Receiver e-mail Address, Sending Interval and Sending Times.

- **SMTP** (Simple Mail Transfer Protocol) is a protocol for sending e-mail messages between servers you need to input the mail server

address in this field.

- **Sender e-mail** is the person's e-mail address that will be sending the e-mail.
- **Receiver e-mail** is the e-mail address of the person that will receive the e-mail.
- **Sending Interval** is the period of time between each e-mail being sent to the receiver. If the setting is at 10 seconds, a new e-mail will be sent in 10 seconds interval to the receiver.
- **Sending Time** is the number of times the e-mail will be sent to the receiver before it terminates.

Select **“Trigger I/O Output”** and enter the setting for the duration of the output device for Output 1 time and Output 2 time in seconds.

### **I/O Input 2 Trigger:**

Refer to “I/O Input 1 Trigger” information above.

### **Save/Cancel:**

After making sure all settings in the System are correct, click on the **“Save”** icon to store the settings for the DCS-1000W. You can alternatively click on the **“Cancel”** icon to restore all settings to the values last saved to or retrieved from DCS-1000W.

### **Warning**

When connecting other devices through the I/O connectors, please make sure the maximum current of 100mA is strictly observed. Any failure to do so might cause a loss of power to DCS-1000W and possibly cause serious damage to the Internet Camera.

*Please refer to the appendix for detailed information regarding the I/O Connector.*

## System Administration - Information

The Information menu contains commands for displaying information about the DCS-1000W.

Click on **“Information”** in the system administration menu bar and the Information screen will appear as illustrated below:

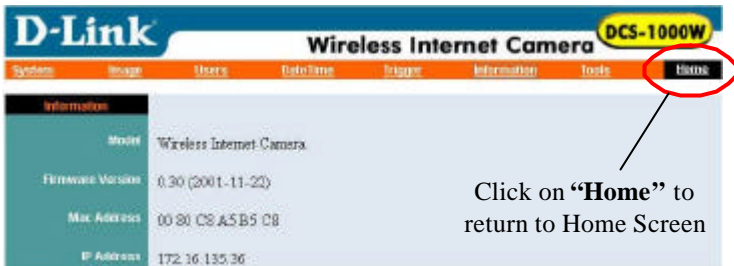

The Information table provides detailed information about the DCS-1000W such as the Model Name, Firmware Version, Mac Address, and IP Address.

## System Administration - Tools

The Tools menu contains commands for restarting DCS-1000W.

Click on **“Tools”** in the system administration menu bar and the Tools screen will appear as illustrated below:



Click on **“Home”** to return to Home Screen

### Reset:

The Reset command restarts the DCS-1000W as if you were to turn it off and then on again, with settings being retained. The Reset panel contains the message “Do you really want to reset this device?” and a YES button. If you do not want to reset DCS-1000W, exit the panel without clicking YES, otherwise, click on the **“YES”** icon and the reset process will initiate.

## Factory Reset:

A factory reset restarts the DCS-1000W and returns all of its settings to their default values. The Factory Reset panel contains the message “Do you really want to factory reset this device?” and a YES button. If you do not want to carry out a factory reset command, exit the panel without clicking YES, otherwise click on the “**YES**” icon and factory reset will be initiated.

## Note:

The Network setting must be reconfigured after a Factory Reset.

Once the configuration is completed click on “**Home**” to return to the Home screen and select the desired Viewing Image either through ActiveX Mode or Java Mode as described in the next section.

The last step is to position the DCS-1000W to the desired location appropriate for your purpose, followed by adjustment of the DCS-1000W focus, by manually turning the lens clockwise or anti-clockwise to the desired image quality. *Please refer to the appendix for detailed information regarding Adjusting DCS-1000W Focus and Replacing the Lens.*

## View Image – ActiveX Mode

To view video images from the browser, click on “**View Image – ActiveX Mode**” from the Home screen to access the video images from Internet Explorer as illustrated below:

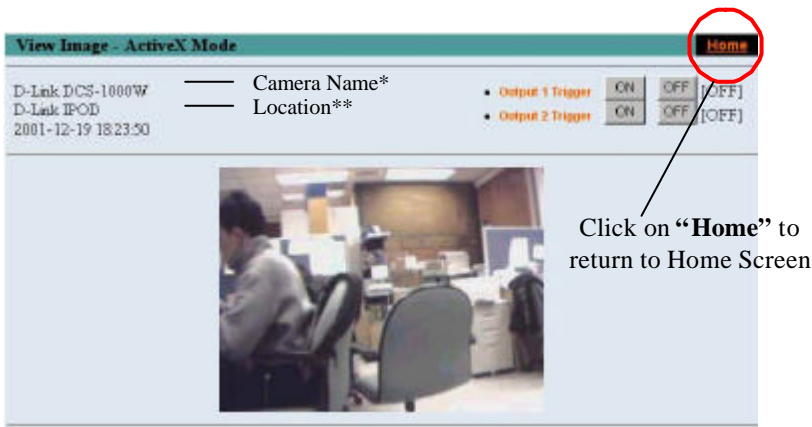

**Camera Name \*** - The Camera name will be display when the Camera Name field is entered in the Web Configuration setting under “**System**”.

**Location\*\***- The location of DCS-1000W will be displayed when the Location field is entered in the Web Configuration settings under “**System**”.

**Note:**

*Please refer to the appendix on how to install ActiveX.*

1. *Install to the Web Server*
2. *Install to your Local PC*

In the View Image – ActiveX Mode you are allowed two output trigger options. Just click on the desired selection “**ON**” or “**OFF**” to utilize the options for each of the output triggers (Output 1 trigger or Output 2 trigger).

**Note 1:**

Output trigger will send a 5V signal to the device connected to the DCS-1000W. A maximum of two devices is permitted to connect to DCS-1000W to utilize the output trigger function. *Please refer to appendix for detailed information.*

**Note 2:**

The Administrator has the authority to allow user’s to set the output trigger functions through the setting in the “Users” of System Administration menu bar.

## View Image – Java Mode

Click on “**View Image – Java Mode**” from the Home screen to access the video images from the Internet Explorer or Netscape browser as illustrated below:

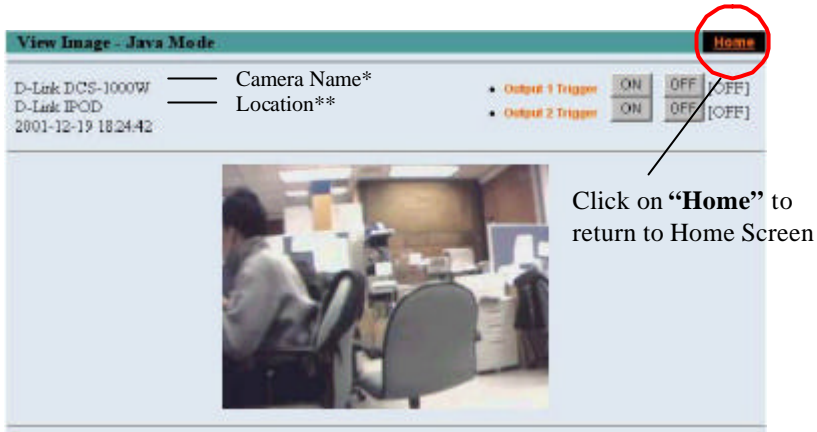

**Camera Name\*** - The Camera name will be display when the Camera Name field is entered in the Web Configuration setting under “**System**”

**Location\*\*** - The location of DCS-1000W will be displayed when the Location field is entered in the Web Configuration settings under “**System**”.

In the View Image – Java Mode you are allowed two output triggers. Just click on the desired selection “**ON**” or “**OFF**” to utilize the options for each of the output triggers (Output 1 trigger or Output 2 trigger).

### Note 1:

Output trigger will send a 5V signal to the device connected to DCS-1000W. A maximum of two devices is permitted to connect to DCS-1000W to utilize the output trigger function. *Please refer to appendix for detailed information.*

### Note 2:

Administrator has the authority to allow user’ s the permission to set the output trigger functions through the setting in the “**Users**” of System Administration menu bar.



# IPView Application Installation

---

## Installation

Insert the CD-ROM into the CD-ROM drive to initiate the auto-run program. Once completed a menu screen will appear as follows:



To install the IPView application click on the "IPView" button to activate the installation procedure for the application program.

Once executed a prompt will appear requesting the input of the desired language selection. Make the desired selection and click on “**OK**” to continue.



The Welcome screen will appear. Click on the “**Next**” button to proceed with the installation.

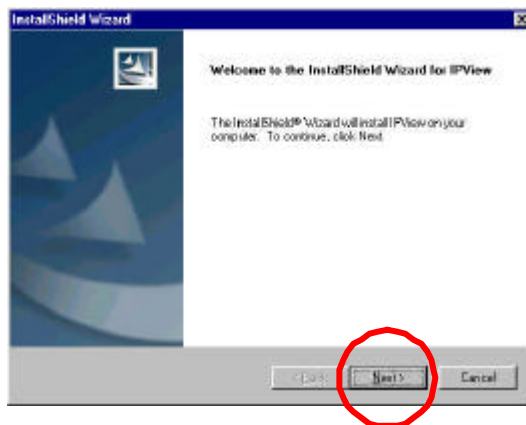

The License Agreement prompt will appear as below. Read the details carefully and click on the **“Yes”** icon to continue with the installation procedure.

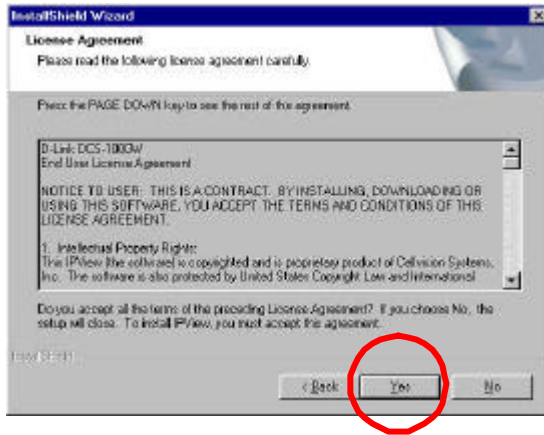

A prompt will appear and in the Destination Location dialog box, you may click on **“Next”** to accept the recommended destination location or click on **“Browse”** to select another location. After specifying the desired destination location, click on **“Next”** to proceed further.

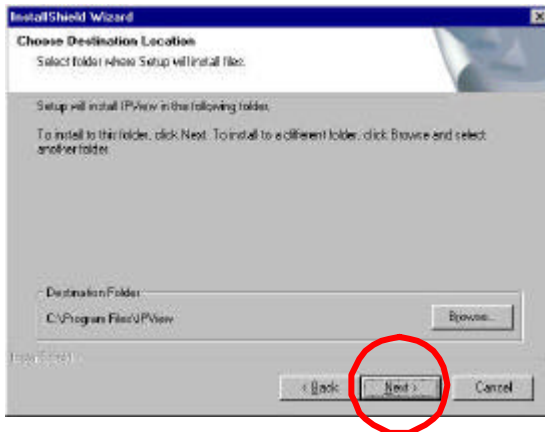

The Select Program Folder prompt will appear providing information of where the IPView application will be located, click on “**Next**” to continue. If you wish to modify your settings, click on “**Back**” to return to the previous screens.

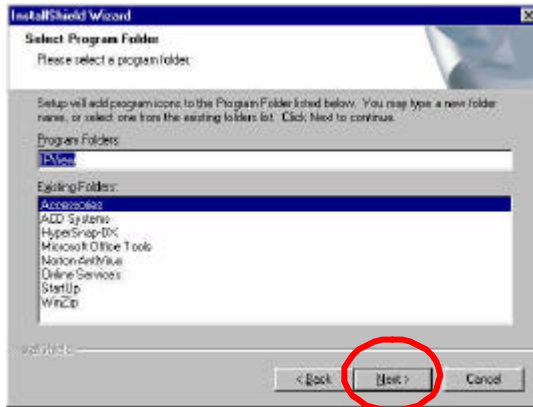

Please wait until one of the two dialog box to appear, select either “*Yes, I want to restart my computer now*” and click on the “**Finish**” icon to restart the computer to complete the installation procedure.

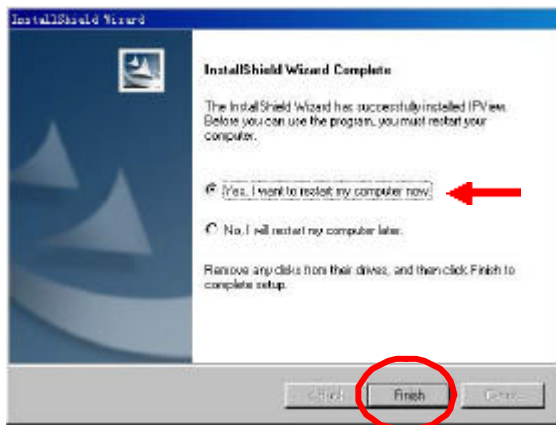

or click on the “**Finish**” icon to complete the installation procedure

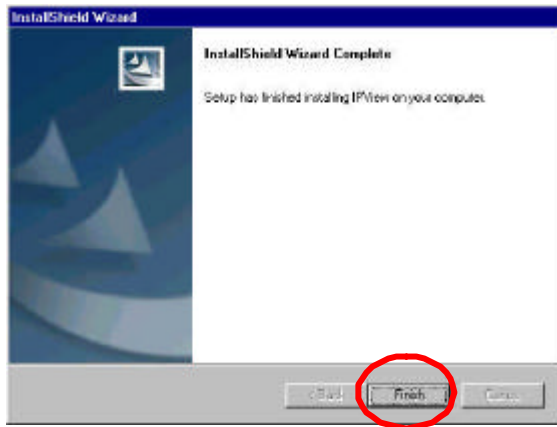

After successfully installing the IPView, the application program for DCS-1000W is automatically installed to \Programs\Files Directory.

To start running the IPView click on windows **Start > Menu > Programs > IPView >IPView**

Once IPView is executed a Login prompt will appear, you must enter the default User Name: **admin** into the respective field and click on “**OK**” to log into the application.







# How to Change Password

## Change Password

When IPView is used for the first time it is highly recommended to change the **User Name** and **Password** by the Administrator to constrain users access to the IPView application. Once the **User Name** and **Password** are defined only the Administrator has access to the management of IPView applications. This procedure should be done as soon as possible to prevent unauthorized usage of IPView application.

Once IPView is executed a **Login** prompt will appear, you must enter the default **User Name** : **admin** into the respective field and click on **“OK”** to log into the application.



To change the **User Name** and **Password** select **“Tools”** > **“Options”**. The **Options** dialog box will appear as illustrated below.

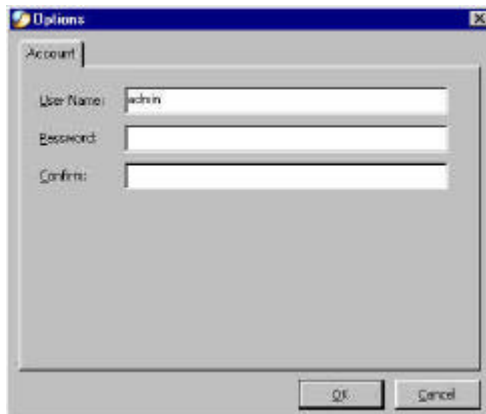



The administrator needs to enter a **User Name** , **Password** and **Confirm** password into the respective fields. Once all the new details are entered click on the “**OK**” icon.

Make sure to save any changes you have made to keep the information updated.

**Note:**

Alternatively you can click the **Options** icon  as illustrated or use the hot key “**F10**”.

## How to Change IP Address

### Change IP Address

To change an IP Address for a camera select “**Camera**” > “**Add**”. An **Add Camera** dialog box will appear as illustrated below.



Click on the “**Browse**” icon, the **Browse Camera** dialog box will appear with a blank screen as illustrated below.

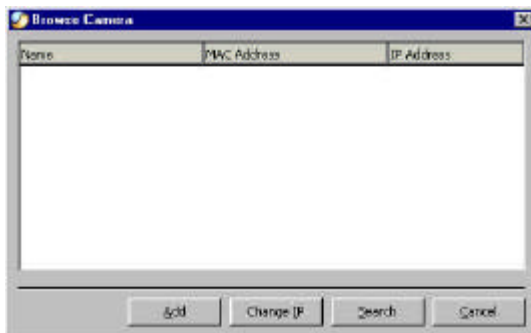

Click on the “**Search**” icon and IPView will detect and search all the available camera’s that are installed on the local area network as depicted below:

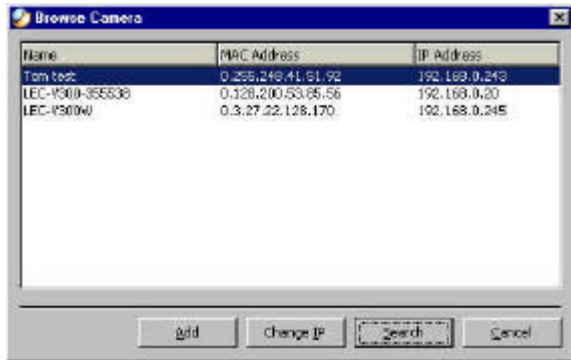

You must highlight the camera you wish to change the IP Address and click on the “**Change IP**” icon and the **Change IP Address** dialog box will appear as depicted below:



Enter the new **IP Address** along with the **Subnet Mask** and **Default gateway** into the respective fields and click on the “**OK**” icon and IPView will automatically change the IP Address.

Make sure to save any changes you have made to keep the information updated.

# How to Add a Camera

## Add Camera

To add a new camera select **“Camera”** > **“Add”**. An **Add Camera** dialog box will appear as illustrated below.

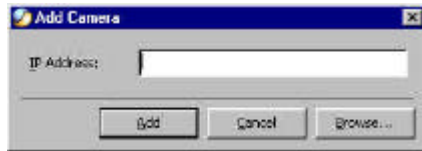

You can enter the IP Address of the camera in the specified field and click the **“Add”** icon to add a new camera. If the IP Address is entered incorrectly a dialog box will appear to notify the error.



If you are unsure of the IP Address of the camera you can click on the **“Browse”** icon, the **Browse Camera** dialog box will appear with a blank screen as illustrated below.

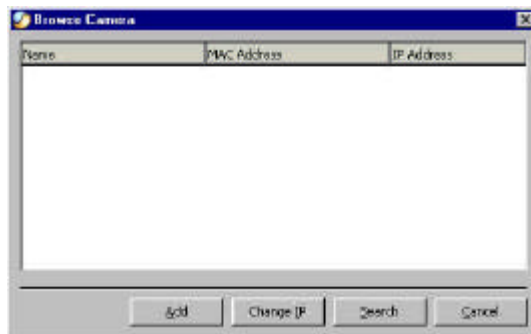

Click on the “**Search**” icon and IPView will detect and search all the available camera’s that are installed on the local area network as depicted below:

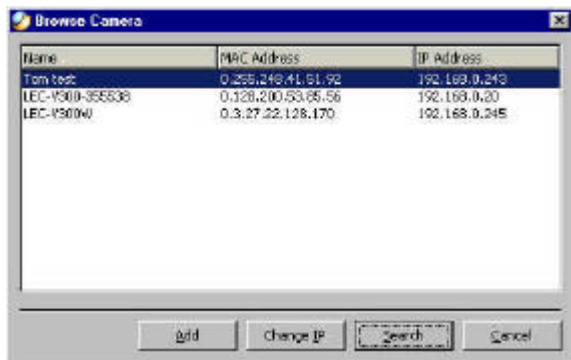

You must highlight the camera you wish to add and click on the “**Add**” icon. The **Add Camera** dialog box will appear once again with the IP Address entered. Click on the “**Add**” icon and the camera will be automatically added into IPView list view format.

Alternatively you can double click on the camera you wish to add and the **Add Camera** dialog box will appear once again with the IP Address entered. Click on the “**Add**” icon and the camera will be automatically added into IPView list view format.

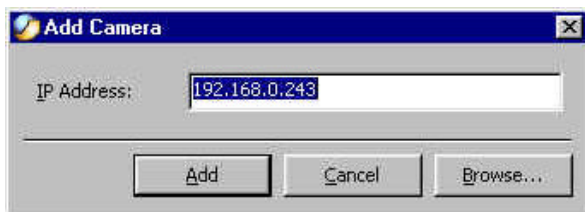

If the **Login Camera** dialog box appears make sure to enter the correct **User Name** and **Password** and click on the “**OK**” icon and the camera will be added into IPView in list format. If the **User Name** and **Password** is entered incorrectly the camera will not be added into IPView.



The above dialog box will appear only if administrator has already set the **User Name** and **Password** during the Web Configuration setting.

If you forget to highlight the camera you wish to add a dialog box will appear to notify you of the error.



Make sure to save any changes you have made to keep the information updated.

**Note 1:**

You are only able to add one camera at a time.

**Note 2:**

Alternatively you can click the **Add** icon  as illustrated or use the hot key “**Shift+Ins**”.

# How to Delete a Camera

## Delete Camera

To delete a camera you must highlight the camera you wish to delete from IPView list view format. From the menu bar select “**Camera**” > “**Delete**”. A **Delete Camera** dialog box will appear and click on the “**Yes**” icon to delete the camera or click on “**No**” if you do not wish to delete the camera as illustrated below.

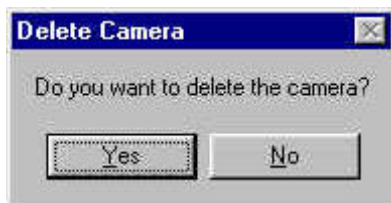

Make sure to save any changes you have made to keep the information updated.

### Note:

Alternatively you can click the **Delete** icon  as illustrated or use the hot key “**Del**”.

# How to View a Camera

## View Camera

From the menu bar select “**View**” > “**4 Cameras**” (other choices are available in **1 Camera**, **9 Cameras** and **16 Cameras** viewing format) and the viewing screen will appear with the video image

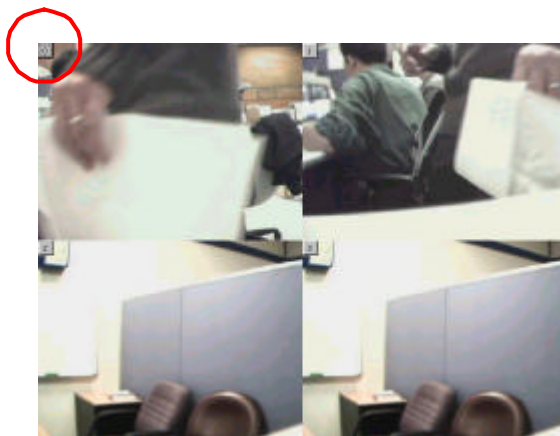

### Note:





The icon on the upper left corner of the screen will appear with the camera number that is being displayed

To return to the IPView list view format, click on the icon located on the upper left corner of the screen and a case sensitive menu will appear. Select “**List**” and the viewing image will return to the list view format.

### Note 1:

A maximum of 16 cameras are available for viewing with the IPView application.

### Note 2:

Alternatively you can click the **1 Camera** icon  as illustrated or use the hot key “**Ctrl+F3**”. For **4 Cameras** , **9 Cameras**  and **16 Cameras**  click the respective icon or use the hot key as follows “**Ctrl+F4**”, “**Ctrl+F5**” and “**Ctrl+F6**”. To return to list view format use the hot key “**Ctrl+F1**”.

# How to take a Snap-Shot of a Camera

## Snap shot Camera

To snap shot a camera you must highlight the camera you wish to snap shot from the list view format. From the menu bar select **“Camera”** > **“Snap shot”**. A **Save Image** dialog box will appear for you to save the snap shot picture.

A second alternative is from the viewing mode either 1, 4, 9, 16 cameras click on the icon located on the upper left corner of the screen and a case sensitive menu will appear and select the **“Snap shot”** icon. A **Save Image** dialog box will appear for you to save the snap shot picture.

### Note:

Alternatively you can click the **Snap shot** icon  as illustrated or use the hot key **“F5”**.

# How to Adjust the Property Setting

## Property Setting

**“Property”** is initiated by selecting **“Camera”** > **“Property”** and a dialog box will appear allowing settings of Web Configuration and upgrade firmware (Please refer to the appendix for detailed information). The **Camera Property** dialog box will appear for you to select the desired options from the tab selections to Configure the camera as shown below.



## General

Allows settings for the camera name, location and administrator information such as administrator ID and password. Please refer to the Web Configuration section under “**System Administration – System**” for further details.

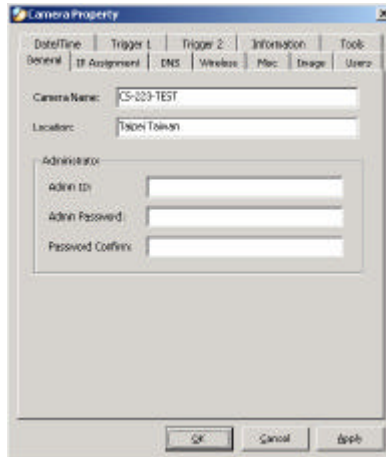

The screenshot shows the 'Camera Property' dialog box with the 'General' tab selected. The 'Camera Name' field contains 'CS-003-TEST' and the 'Location' field contains 'Talon Tolman'. Under the 'Administrator' section, there are three empty text boxes for 'Admin ID', 'Admin Password', and 'Password Confirm'. At the bottom, there are 'OK', 'Cancel', and 'Apply' buttons.

## IP Assignment

There are two options to select from the IP Assignment either **Manually Assign** or **Assign Automatically Using**. Please refer to the Web Configuration section under “**System Administration – System**” for further details.



The screenshot shows the 'Camera Property' dialog box with the 'IP Assignment' tab selected. The 'Manually Assign' radio button is checked. The 'IP Address' field contains '172.16.100.223', the 'Subnet Mask' field contains '255.255.255.0', and the 'Default Gateway' field contains '0.0.0.0'. Under the 'Automatic Assign' section, there are three unchecked checkboxes: 'RARP', 'BOOTP', and 'DHCP'. Below these are three empty text boxes for 'Service Name', 'User ID', and 'Password'. At the bottom, there are 'OK', 'Cancel', and 'Apply' buttons.

## DNS

DNS (Domain Name System) server is an Internet service that translates domain names into IP addresses. Enter at least one DNS IP Address. Please refer to the Web Configuration section under **“System Administration – System”** for further details.

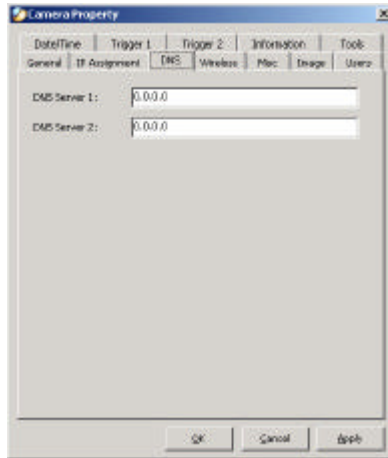

**Wireless** (Please skip this section if your camera is not wireless)

Allows setting for connection mode, network name, wireless channel, and WEP key. Please refer to the Web Configuration section under **“System Administration – System”** for further details.

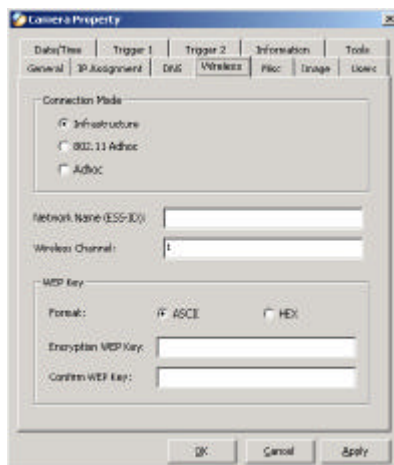

## Misc

Allows setting for LED Control, ActiveX control location, and second port. Please refer to the Web Configuration section under **“System Administration – System”** for further details.

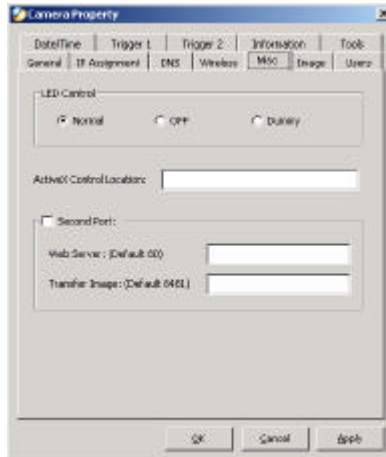

## Image

Image provides the settings for the video image of the camera such as brightness, contrast, hue, resolution, compression, frame rate, and light freq. Please refer to the Web Configuration section under **“System Administration – Image”** for further details.

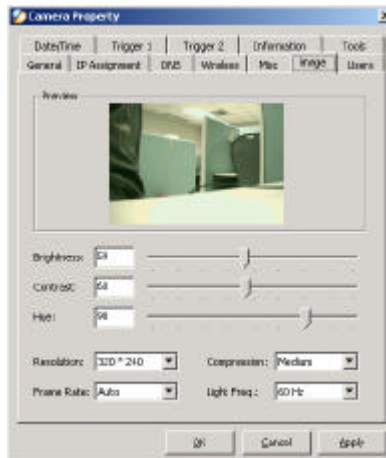

## Users

Contain commands to allow system administrator to assign legal users who are permitted to monitor the camera from the remote site by **Add** or **Delete** user.

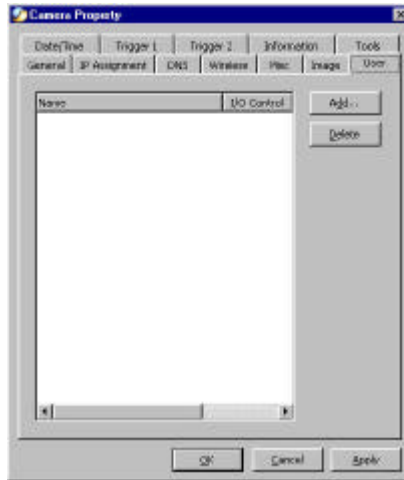

To add a user click on the “**Add**” icon and the **Add User** dialog box will appear. Enter the User Name and Password into the specific field. Select the I/O Output Control to give users the privilege of accessing the I/O Output Control.

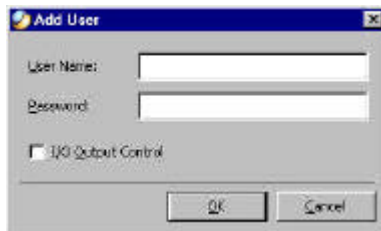

To delete a user, select the user and click on the “**Delete**” icon.

Please refer to the Web Configuration section under “**System Administration – Users**” for further details.

## Date/Time

Contain commands for setting the camera’s time and date to provide correct time information to users who might be thousands of miles away in the remote site by selecting **Synchronized with Time Server** or **Set Manually**. Please

refer to the Web Configuration section under **“System Administration – TimeDate”** for further details.

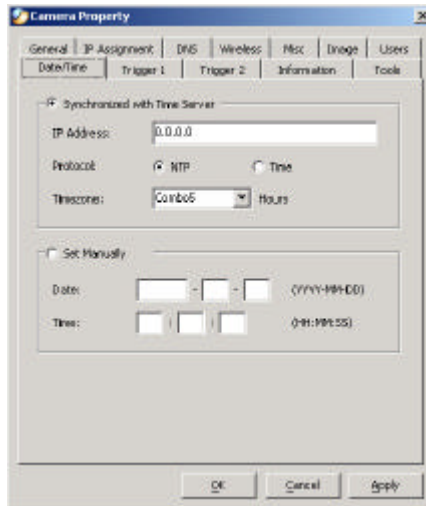

### Trigger 1

Contains commands for setting the I/O Trigger connectors providing the physical interface for 1 digital output and 1 digital input that is used for connecting a diversity of external alarm devices to the camera such as IR-Sensor and alarm relay. Please refer to the Web Configuration section under **“System Administration – Trigger”** for further details.

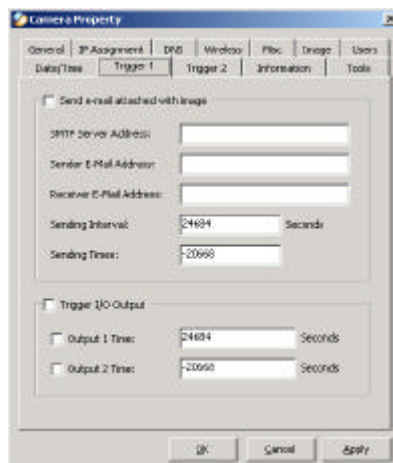

## Trigger 2

Contains commands for setting the I/O Trigger connectors providing the physical interface for 1 digital output and 1 digital input that is used for connecting a diversity of external alarm devices to the camera such as IR-Sensor and alarm relay. Please refer to the Web Configuration section under **“System Administration – Trigger”** for further details.

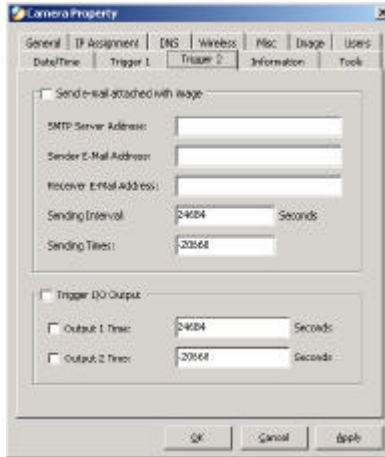

## Information

Displays information about the camera such as the model, firmware version, MAC address, and IP address. Please refer to the Web Configuration section under **“System Administration – Information”** for further details.



## Tools

Contains commands to reset the camera and update firmware (please refer to the appendix for detailed information). Please refer to the Web Configuration section under “**System Administration – Tools**” for further details on reset.

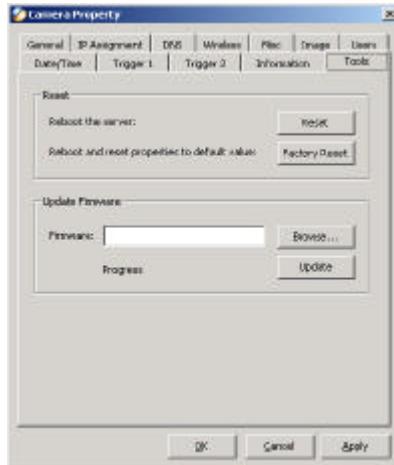

Make sure to save any changes you have made to keep the information updated.

### Note:

Alternatively you can click the **Property** icon  as illustrated or use the hot key “**F2**”.

## Menu Bar

The menu bar provides easier access for users to navigate the IPView with different selections along with hot key capabilities as follows:

### Menu Bar - File

“**File**” on the menu bar provides “**New**”, “**Open**”, “**Save**”, “**Save As**” and “**Exit**” for users to create new files, open existing files, save files, and exit the IPView as depicted below.

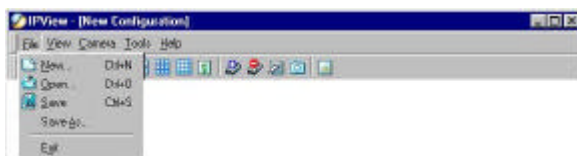

## Menu Bar – View

“View” on the menu bar provide users with management capabilities for “Columns”, “List”, “Camera” and “Refresh”. You can view Camera in “1 Camera”, “4 Cameras”, “9 Cameras”, “16 Cameras”. The “View” menu bar is pictured below.

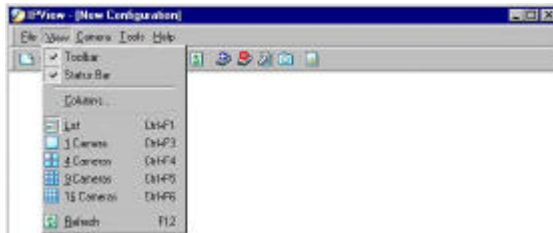

## Columns

When “Columns” is launched a dialog box will appear allowing the option to choose the columns one would like to display in List View as illustrated below.

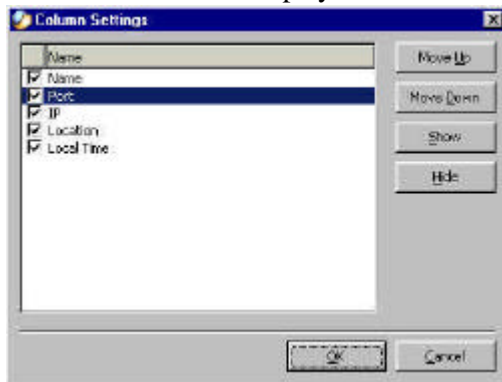

## Viewing Format

You can view the format in “List” view. The “List” viewing format allows easy management and control of each camera.



## List View

“List” view is illustrated below for your reference. You are able to list all the cameras and their properties such as the camera name, IP address, user name, and location will be displayed for ease of control and management.

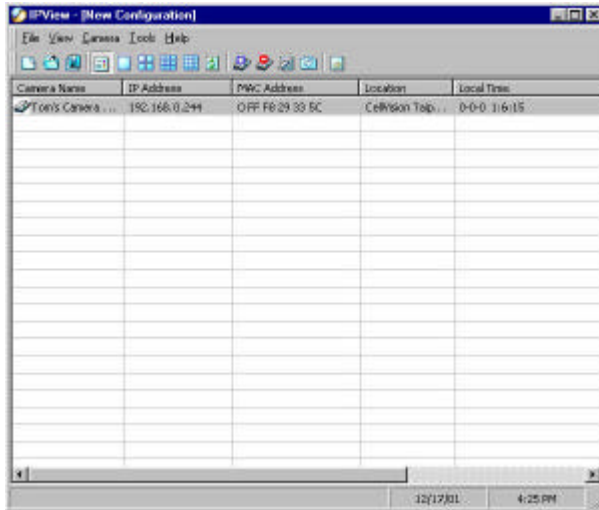

The screenshot shows a window titled "IPView - (New Configuration)" with a menu bar (File, View, Camera, Tools, Help) and a toolbar. Below the toolbar is a table with the following columns: Camera Name, IP Address, MAC Address, Location, and Local Time. The table contains one row of data:

Camera Name	IP Address	MAC Address	Location	Local Time
Tom's Camera ...	192.168.0.244	08FF F629 33 5C	CellPhone Toip...	0-0-0 11:6:15

The status bar at the bottom right shows the date 12/17/01 and the time 4:25 PM.

### Note:

Right click the mouse pad on any kind of the camera will bring up a context sensitive menu which shows the actions you can apply to the selected camera.

Double click on the desired camera will bring up the **Property** dialog box.

To update camera list view just click on the “**Refresh**” icon for Real Time Data and the latest information.

## Menu Bar - Camera

“**Camera**” on the menu bar provides options to manage the camera. One can “**Add**” additional Camera with a maximum of 16 Camera allowed for viewing. Through the management function one can “**Delete**” a camera, manage the “**Property**”, “**Enable**” for real time and take a “**Snap shot**” image. The menu bar is illustrated below:

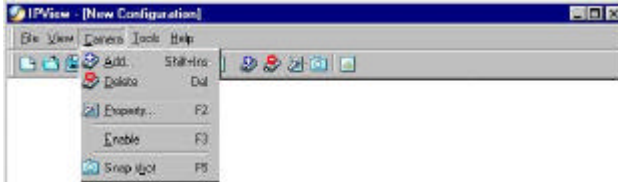

## Enable Function

By default the video image is enabled. There will be a “**check**” next to the **Enable** command to show that the Enable function is working. To disable real-time image select “**Camera**” > “**Enable**” and real-time video image will stop and shutdown.

## Menu Bar - Tools

“**Tools**” on the menu bar allows administrator management of the security settings such as User Name and Password to gain access into the IPView application. From the menu bar select “**Tools**” > “**Options**” and a dialog box will appear. Administrator can change the User Name and Password for security settings to access the application.

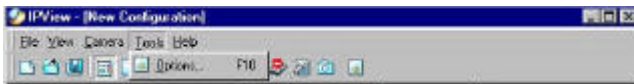

## Menu Bar - Help

“**Help**” on the menu bar provides “**Contents**” and “**About**” to instruct users how to operate the camera in HTML format. From the menu bar select “**Help**” and can choose either “**Contents**” or “**About**” as depicted below:



## IPView Icon Description



Open a new file. Alternatively the hot key is **Ctrl+N**.



Open an existing file. Alternatively the hot key is **Ctrl+O**.



Save a file. Alternatively the hot key is **Ctrl+S**.



List view format. Alternatively the hot key is **Ctrl+F1**.



1 Camera view format. Alternatively the hot key is **Ctrl+F3**.



4 Camera view format. Alternatively the hot key is **Ctrl+F4**.



9 Camera view format. Alternatively the hot key is **Ctrl+F5**.



16 Camera view format. Alternatively the hot key is **Ctrl+F6**.



Refresh IPView application. Alternatively the hot key is **F12**.



Add a camera. Alternatively the hot key is **Shift+Ins**.



Delete a camera. Alternatively the hot key is **Del**.



Property setting to configure the camera. Alternatively the hot key is **F2**.



Snap shot to capture a single still image. Alternatively the hot key is **F5**.



Options to modify the User Name and Password for IPView. Alternatively the hot key is **F10**.



# Uninstall IPView Application

Click on windows **Start Menu / Settings / Control Panel**. A prompt screen will be displayed like the one below and double click on the **Add/Remove Programs** icon.



From the Add/Remove Programs Properties Menu, select **“IPView”** as illustrated below.

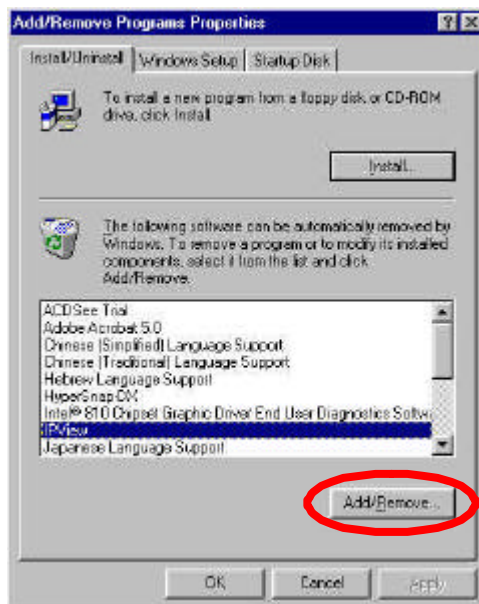

Then click on the **“Add/Remove”** button. A new prompt screen will be displayed like the one below confirming the removal.

Click on the **“OK”** icon to continue the process or click on the **“Cancel”** icon to reject the uninstall process.

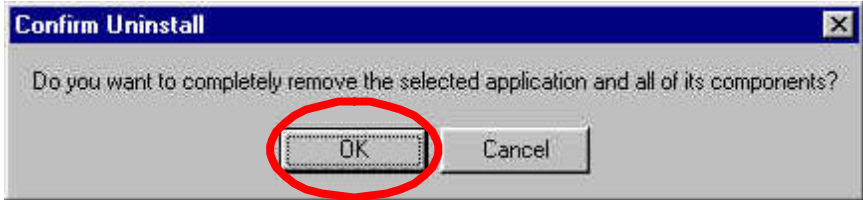

The InstallShield Wizard prompt will appear and click on **“Finish”** to complete the uninstallation procedure.

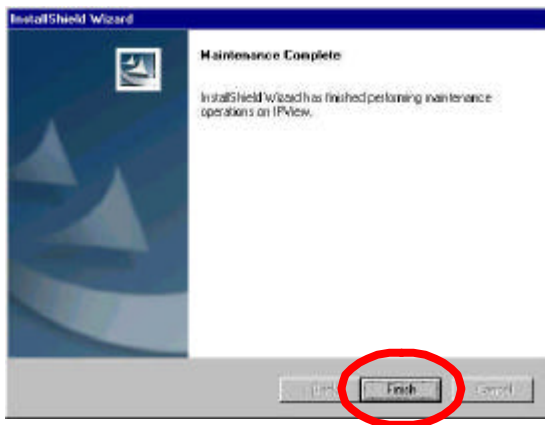

# **Appendix**

## **Frequently Asked Questions**

### **Internet Camera Features**

#### **Q: What is an Internet Camera?**

**A:** DCS-1000W is a standalone system connecting directly to an Ethernet or Fast Ethernet network and supported by the wireless transmission based on the IEEE 802.11b standard. It is different from the conventional PC Camera, the DCS-1000W is an all-in-one system with built-in CPU and web-based solutions providing a low cost solution that can transmit high quality video images for monitoring. The DCS-1000W can be managed remotely, accessed and controlled from any PC/Notebook over the Intranet or Internet via a web browser.

#### **Q: What is the maximum number of users that can be allowed to access DCS-1000W simultaneously?**

**A:** Maximum number of users that can log onto the DCS-1000W at the same time is 64. Please keep in mind the overall performance of the transmission speed will slow down when many users are logged on.

#### **Q: What algorithm is used to compress the digital image?**

**A:** The DCS-1000W utilizes JPEG image compression technology providing high quality images. JPEG is a standard for image compression and can be applied to various web browser and application software without the need to install extra software.

#### **Q: Can I change the wireless antenna attached to DCS-1000W?**

**A:** The wireless antenna can be changed for a variety of reasons such as extending the wireless transmission range, however, please consult authorized distributors before attempting as the connectors must be SMA connector type.

#### **Q: Can I capture still images from the DCS-1000W?**

**A:** Yes you are able to capture still images with the snapshot function from the IPView application supplied with the DCS-1000W CD-ROM. You may also use the first page that shows up with you type in the IP address of the camera. When viewing this page, press the “refresh” button on your web browser to update the image. *Please refer to the User’s Guide for detailed information.*

**Q: What is the wireless transmission range for the DCS-1000W?**

**A:** Generally the wireless distance can go up to 100 meters indoors and up to 300 meters outdoors. The range is limited by the number of walls, ceilings, or other objects that the wireless signals must pass through. Typical ranges vary depends on the types of materials and background Radio Frequency (RF) noise in your home or business and the configuration setting of your network environment.

## **Internet Camera Installation**

**Q: Can the Internet Camera be used outdoors?**

**A:** The DCS-1000W is not weatherproof. It needs to be equipped with a weatherproof case to be used outdoors and it is not recommended.

**Q: What network cabling is required for the DCS-1000W?**

**A:** DCS-1000W uses Category 5 UTP cable allowing 10 Base-T and 100 Base-T networking.

**Q: Can the DCS-1000W be setup as a PC-cam on the computer?**

**A:** No, the DCS-1000W is an Internet Camera used only on Ethernet and Fast Ethernet network and supported by wireless transmission. The D-Link DSB-C100, DSB-C300, DSC-350 or DSC-350F can be used as a PC Camera (Webcam).

**Q: Can the DCS-1000W be connected on the network if it consists of only private IP addresses?**

**A:** DCS-1000W can be connected to a LAN with private IP addresses.

**Q: Can the DCS-1000W be installed and work if a firewall exists on the network?**

**A:** If a firewall exists on the network, port 80 is open for ordinary data communication. However, since DCS-1000W transmits image data, the default port 8481 is also required. Therefore, it is necessary to open port 8481 of the network for remote users to access DCS-1000W.

## **Trouble Shooting**

**Q: I cannot access the DCS-1000W from a web browser?**

**A1:** The possible cause might be the IP Address for the DCS-1000W is already being used by another device. To correct the possible problem, you



need to first disconnect the DCS-1000W from the network. Then run the PING utility (follow the instructions in Appendix B - PING Your IP Address).

**A2:** Another possible reason is the IP Address is located on a different subnet. To fix the problem, run the PING utility (follow the instructions in Appendix B - PING Your IP Address). If the utility returns “no response” or similar, the finding is probably correct, then you should proceed as follows:-

In Windows 95/98/2000 and Windows NT, check that the IP Address of the DCS-1000W is within the same subnet as your workstation.

- Click “Start”, “Setting”, “Control Panel”, and the “Network” icon.
- Select TCP/IP from the “Network” dialog box and from the “TCP/IP Properties” dialog box click on “Specify an IP address”.
- If the DCS-1000W is situated on a different subnet than your workstation, you will not be able to set the IP address from this workstation. To verify make sure the first 3 sections of the IP address of the DCS-1000W corresponds to the first 3 sections of the workstation. Therefore the IP address of the DCS-1000W must be set from a workstation on the same subnet.

**A3:** Other possible problems might be due to the network cable. Try replacing your network cable. Test the network interface of the product by connecting a local computer to the unit, utilizing a standard Crossover (hub to hub) Cable. If the problem is not solved the DCS-1000W might be faulty.

**Q: Why does the Power LED not light up constantly?**

**A:** The power supply used might be at fault. Confirm that you are using the provided power supply, which is DC 5V, for the DCS-1000W and verify that the power supply is well connected.

**Q: Why does the LAN/WLAN LED not light up properly?**

**A1:** There might be a problem with the network cable. To confirm that the cables are working, PING the address of a know device on the network. If the cabling is OK and your network is reachable, you should receive a reply similar to the following (. bytes = 32 time = 2 ms).

**A2:** The network device utilized by the DCS-1000W is not functioning properly, such as hubs or switches. Confirm the power for the devices are well connected and functioning properly.

**A3:** The wireless connection might be at fault. In ad-hoc mode make sure the DCS-1000W wireless channel and ESS-ID is set to match the PC/Notebook wireless channel and ESS-ID for direct communication. Since The DCS-1000W ad-hoc mode supports two modes (802.11 ad-hoc mode and proprietary ad-hoc mode), make sure that you are using the same mode on each device. If they are not the same, the camera will not be accessible.

Under infrastructure mode make sure the ESS-ID on the PC/Notebook and DCS-1000W must match with the Access Point's ESS-ID.

**Q: Why does the DCS-1000W work locally but not externally?**

**A1:** Might be caused from the firewall protection. Check the Internet firewall with your system administrator. The firewall may need to have some settings changed in order for the DCS-1000W to be accessible outside your local LAN.

**A2:** Make sure that the DCS-1000W isn't conflicting with any web server you may have running on your network.

**A3:** The default router setting might be a possible reason. Check that the configuration of the router settings allow the DCS-1000W to be accessed outside your local LAN.

**Q: Why does a series of broad vertical white line appear through out the image?**

**A:** It could be that the CMOS sensor has become overloaded when it has been exposed to bright lights such as direct exposure to sunlight or halogen lights. Reposition the DCS-1000W into a more shaded area immediately as prolonged exposure to bright lights will damage the CMOS sensor.

**Q: The focus on the DCS-1000W is bad, how can I correct it?**

**A1:** Adjust the DCS-1000W focus manually as described in "Adjusting the DCS-1000W Focus" in the Appendix section of this manual.

**A2:** If you have previously changed the supplied CS-type lens, you may have unintentionally installed a C-type lens without fitting the adaptor first.

**Q: Noisy images occur. How can I solve the problem?**

**A1:** The video images might be noisy if the DCS-1000W is used in a very low light environment. To solve this issue you need more lighting.

**A2:** There might be wireless transmission interference. Make sure there are no other wireless devices on the network that will affect the wireless transmission.

**Q: The images is of poor quality, how can I improve the image quality?**

**A1:** Make sure that your computers display properties are set to at least 15-bit color. Using 16 or 256 colors on your computer will produce dithering artifacts in the image, making the image look as if it has bad quality.

**A2:** The configuration on the DCS-1000W image display is incorrect. Through the Web Configuration Image section of the web management you need to adjust the image related parameter for improve images such as brightness, contrast, hue and light frequency. Please refer to the Web Configuration section for detail information.

**Q: There are no images available through the web browser?**

**A1:** The ActiveX might be disabled. If you are viewing the images from Internet Explorer make sure ActiveX has been enabled in the Internet Options menu. Alternatively, you can use the Java Applet for viewing the required images.

**A2:** If you are using Windows XP, please make sure that you have downloaded Java and installed it properly.

**A3:** Make sure that your web browser supports Java. If you are using Internet Explorer or Netscape Navigator with a version number of lower than 4, then you will need to upgrade your web browser software in order to view the streaming video transmitted by the DCS-1000W.

## **How to PING Your IP Address**

The PING (Packet Internet Groper) command can determine whether a specific IP address is accessible by sending a packet to the specific address and waiting for a reply. It can also provide a very useful tool to confirm if the IP address conflicts with DCS-1000W over the network.

Follow the step-by-step procedure below to utilize the PING command but first you must disconnect DCS-1000W from the network.

Start a DOS window.

Type ping x.x.x.x, where x.x.x.x is the IP address of the DCS-1000W.

The succeeding replies as illustrated below will provide useful explanation to the cause of the problem with DCS-1000W IP address.

## I/O Connector

### I/O Connector Definition for DCS-1000W

An 8-pole connector is provided for auxiliary IO connections to the DCS-1000W.

The IO connector provides the physical interface for 2 digital outputs and 2 digital inputs that are used for connecting a diversity of external alarm devices to the DCS-1000W such as IR-Sensor and alarm relay.

The digital input is used for connecting external alarm devices and once triggered images will be taken and e-mailed.

The supported transistor output can give a maximum of DC 5V to the externally connected alarm devices and once triggered the current will activate the devices.

In 11 In 12	In 11 & In 12 is a pair for digital input. It works at voltage 5V
In 21 In 22	In 21 & In 22 is a pair for digital input. It works at voltage 5V
Out 1 + Out 1 -	Out 1 + & Out 1 - is a pair for digital out. The out put voltage is 5 V and maximum current is 100 mA
Out 2 + Out 2 -	Out 2 + & Out 2 - is a pair for digital out. The out put voltage is 5 V and maximum current is 100 mA

## I/O Schematic Diagram

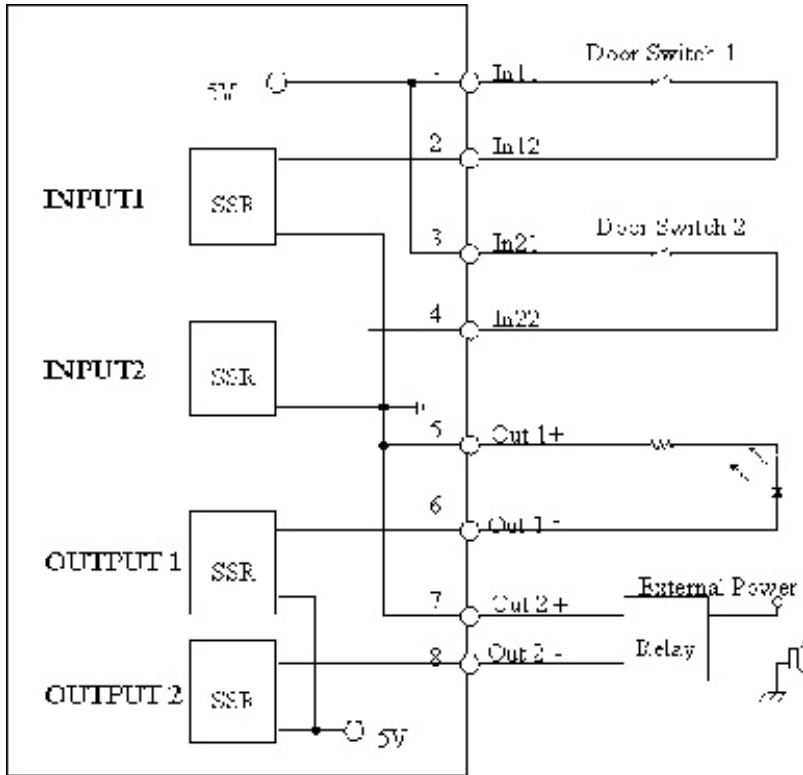

### Warning

1. When connecting a device to the Input connector, the device must be a passive component without voltage and electrical current.
2. When connecting other devices through the Output connector, please make sure the maximum current of DC 5V, 100mA is strictly observed.
3. Any failure of the above two points might cause serious damage to the camera.

### Note:

Through the Web Configuration in the Trigger section, you must first enable the trigger function. Please refer to the Web Configuration section for detailed information.

# Upgrade Firmware

You can update the firmware from the IPView application. With IPView running, select **Camera > Properties** and the **Camera Property** dialog box will appear. Select the **Tools** tab and enter the full path of the firmware binary file name in the Update Firmware field or you can click on the **“Browse”** button to select the file. Once the firmware file is entered click on the **“Update”** button to proceed with the update process. Once completed click on the **“OK”** icon as illustrated below

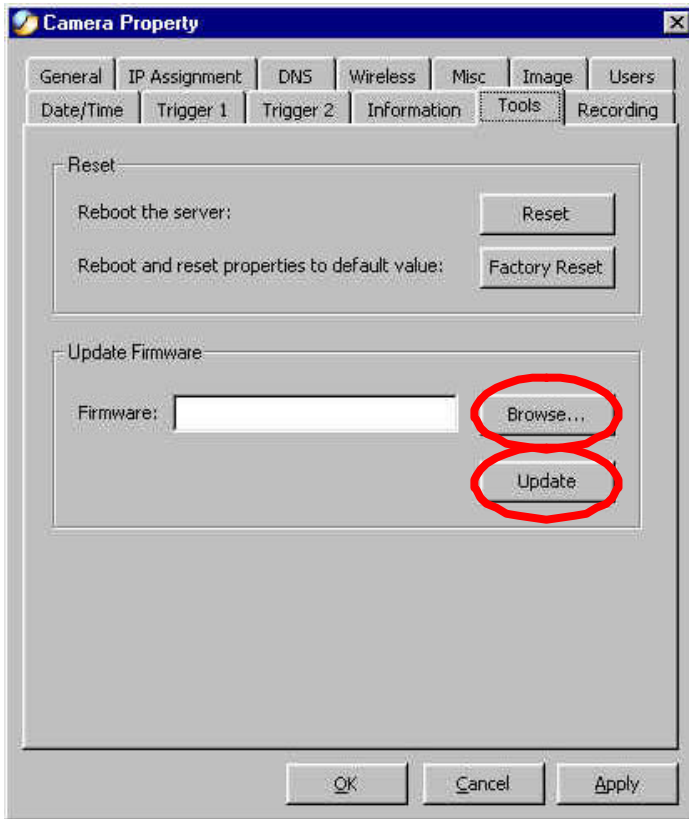

## Warning

The download firmware procedure cannot be interrupted. If the network connection is broken during the download procedure it might possibly cause serious damage to the Internet Camera.

## Time Zone Table

GMT stands for Greenwich Mean Time, which is the global time that all time zones are measured from.

(GMT-12:00) International Date Line West  
(GMT-11:00) Midway Island, Samoa  
(GMT-10:00) Hawaii  
(GMT-09:00) Alaska  
(GMT-08:00) Pacific Time (US & Canada); Tijuana  
(GMT-07:00) Arizona  
(GMT-07:00) Chihuahua, La Paz, Mazatlan  
(GMT-07:00) Mountain Time (US & Canada)  
(GMT-06:00) Central America  
(GMT-06:00) Central Time (US & Canada)  
(GMT-06:00) Guadalajara, Mexico City, Monterrey  
(GMT-06:00) Saskatchewan  
(GMT-05:00) Bogota, Lima, Quito  
(GMT-05:00) Eastern Time (US & Canada)  
(GMT-05:00) Indiana (East)  
(GMT-04:00) Atlantic Time (Canada)  
(GMT-04:00) Caracas, La Paz  
(GMT-04:00) Santiago  
(GMT-03:30) Newfoundland  
(GMT-03:00) Brasilia  
(GMT-03:00) Buenos Aires, Georgetown  
(GMT-03:00) Greenland  
(GMT-02:00) Mid-Atlantic  
(GMT-01:00) Azores  
(GMT-01:00) Cape Verde Is.  
(GMT) Casablanca, Monrovia  
(GMT) Greenwich Mean Time : Dublin, Edinburgh, Lisbon, London  
(GMT+01:00) Amsterdam, Berlin, Bern, Rome, Stockholm, Vienna  
(GMT+01:00) Belgrade, Bratislava, Budapest, Ljubljana, Prague  
(GMT+01:00) Brussels, Copenhagen, Madrid, Paris  
(GMT+01:00) Sarajevo, Skopje, Warsaw, Zagreb  
(GMT+01:00) West Central Africa  
(GMT+02:00) Athens, Istanbul, Minsk  
(GMT+02:00) Bucharest  
(GMT+02:00) Cairo  
(GMT+02:00) Harare, Pretoria  
(GMT+02:00) Helsinki, Kyiv, Riga, Sofia, Tallinn, Vilnius  
(GMT+02:00) Jerusalem  
(GMT+03:00) Baghdad  
(GMT+03:00) Kuwait, Riyadh  
(GMT+03:00) Moscow, St. Petersburg, Volgograd  
(GMT+03:00) Nairobi

(GMT+03:30) Tehran  
(GMT+04:00) Abu Dhabi, Muscat  
(GMT+04:00) Baku, Tbilisi, Yerevan  
(GMT+04:30) Kabul  
(GMT+05:00) Ekaterinburg  
(GMT+05:00) Islamabad, Karachi, Tashkent  
(GMT+05:30) Chennai, Kolkata, Mumbai, New Delhi  
(GMT+05:45) Kathmandu  
(GMT+06:00) Almaty, Novosibirsk  
(GMT+06:00) Astana, Dhaka  
(GMT+06:00) Sri Jayawardenepura  
(GMT+06:30) Rangoon  
(GMT+07:00) Bangkok, Hanoi, Jakarta  
(GMT+07:00) Krasnoyarsk  
(GMT+08:00) Beijing, Chongqing, Hong Kong, Urumqi  
(GMT+08:00) Irkutsk, Ulaan Bataar  
(GMT+08:00) Kuala Lumpur, Singapore  
(GMT+08:00) Perth  
(GMT+08:00) Taipei  
(GMT+09:00) Osaka, Sapporo, Tokyo  
(GMT+09:00) Seoul  
(GMT+09:00) Yakutsk  
(GMT+09:30) Adelaide  
(GMT+09:30) Darwin  
(GMT+10:00) Brisbane  
(GMT+10:00) Canberra, Melbourne, Sydney  
(GMT+10:00) Guam, Port Moresby  
(GMT+10:00) Hobart  
(GMT+10:00) Vladivostok  
(GMT+11:00) Magadan, Solomon Is., New Caledonia  
(GMT+12:00) Auckland, Wellington  
(GMT+12:00) Fiji, Kamchatka, Marshall Is.  
(GMT+13:00) Nuku'alofa



# Xplug Control Installation

## Installation to a Web Server

### **Important Information**

It is highly recommended to install the Xplug Control application to the Web Server for IE 5.0. It must be installed to a Public Domain with Fixed IP address.

#### **1. Installation:**

Copy the “xplug.ocx” file to any Web Server table. Note the web address of the file location so that you can use it in the next step.

#### **2. Configuration:**

From the Web Configuration menu select “System” and under the “Loading ActiveX From” input web server location (<http://www.web server location.com/>).

Once the settings are completed you should now be able to access the Internet Camera from the web browser by selecting ActiveX mode.

#### **Note:**

Set your browser security level to “Low” so that your browser will allow ActiveX control of the camera.

## Installation to a Local PC

Insert the CD-ROM into the CD-ROM drive to initiate the auto-run program. Once completed a menu screen will appear as follows:



To install Xplug Control click on the **"Xplug Control"** button to activate the installation procedure for the plug-in program.

Once executed a prompt will appear requesting the input of the desired language selection. Make the desired selection and click on **"OK"** to continue.



The Welcome screen will appear. Click on the “Next” button to proceed with the installation.

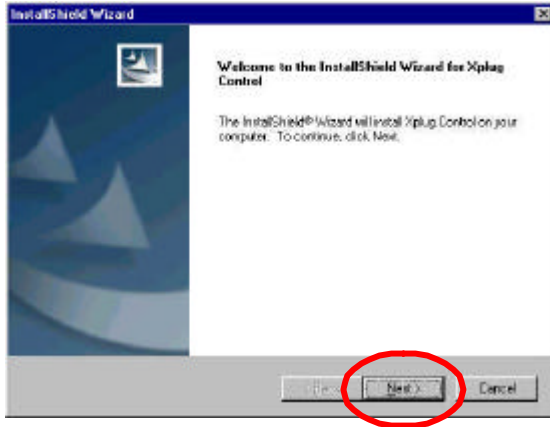

The License Agreement prompt will appear as below. Read the details carefully and click on the “Yes” icon to continue with the installation procedure.

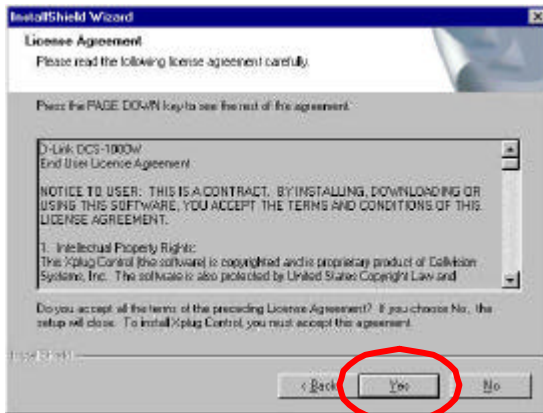

Click on the **“Finish”** button to complete Setup of the Xplug Control Utility program for the DCS-1000W.

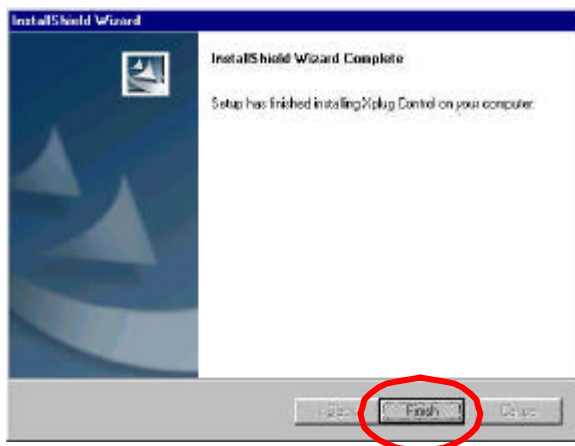

## Adjusting the Cameras Focus

The DCS-1000W features an exchangeable C/CS-type lens that can be used for different applications as necessary. It supports rotational focus control so the lens can be adjusted to focus under normal and stable conditions to maximize the image quality of the DCS-1000W.

To adjust the focus of the lens you will need to turn the lens slowly in either clockwise or anti-clockwise direction until the desired image appears. DO NOT over-turn the lens in either of the directions as it will be out of focus. Unless you want to substitute the lens DO NOT unscrew more than 1.0mm apart from the Fixed Lens Assembly.

To help you get the best image quality, keep in mind that while adjusting the DCS-1000W's focus you can preview the image quality from your Web browser.

Please refer to the diagram below when adjusting the camera lens.

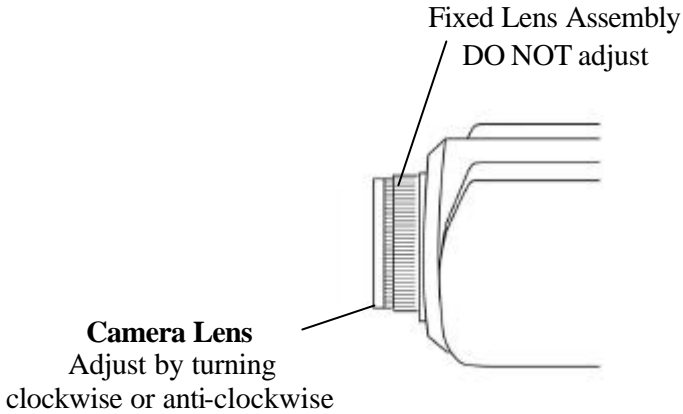

**Note:**

You can further adjust the DCS-1000W's image quality through the Web Configuration under System Administration - Image. Please refer to Web Configuration section for further details.

**Warning**

Direct exposure to sunlight may cause permanent damage to the CMOS sensor. Therefore do not expose the Internet Camera's lens directly to sunlight. When operation is required in glaring light environment, it is recommended to use an iris lens.

The Internet Camera is designed for indoor usage and if your application requires prolong exposure to sunlight, a sun visor is recommended to protect the Internet Camera.

## Replacing the Lens

Since the DCS-1000W is designed with a CS- mount, the lens equipped with the DCS-1000W can be replaced with any standard C or CS lens commonly used within the surveillance industry.

Follow the instructions below to replace the supplied lens with any C or CS type lens.

1. Unscrew the DCS-1000W lens
2. When using a C-lens, attach the new lens to a CS-C adapter
3. Screw the new lens onto the DCS-1000W. If appropriate, adjust the iris according to the prevailing light conditions.
4. Refer to *Adjusting the DCS-1000W Focus* on the previous page.
5. Refresh the web browser and monitor the results from the DCS-1000W.

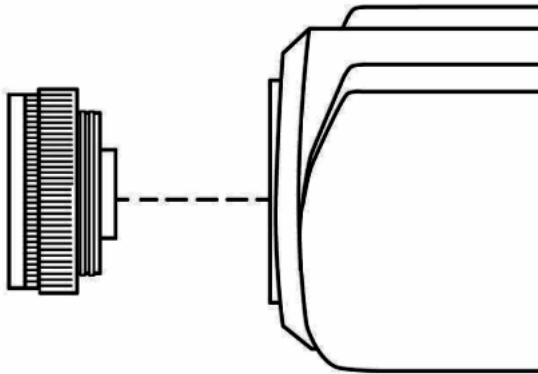

# **Specifications**

## **Video specification**

Resolution:	640 x 480 pixel
Sensor:	1/3" color CMOS sensor
Gain control:	Automatic
Exposure:	Automatic
White Balance:	Automatic
Shutter:	Electronics 1/60 ~ 1/15000 sec
Minimum Illumination:	<u>2.5lux@F1.4</u> , 3000K color
Focal Length:	6.0 mm
Aperture:	f=1.8
Focus Extent:	20 cm -
Lens mounting:	Fixed board lens, CS-mount type

## **Image (Video Setting)**

Image compression:	JPEG
Frame rate:	<u>30fps@QCIF</u> , <u>20fps@CIF</u> , 3fps@VGA
Compression Rate selection:	5 level(Very Low, Low, Medium, High, Very High)
Frame rate setting:	1, 5, 7, 15, 20, auto (depends on the video format)
Video resolution:	160x120, 320x240, 640x480
Brightness control:	Range 1- 128
Contrast control:	Range 1- 128
Hue control:	Range 1- 128

## **System Hardware**

LAN Connector:	One RJ-45 port to connect to 10/100Mbps Ethernet, auto-sensed		
Wireless LAN:	Built-in 802.11b wireless LAN module (Wi-Fi compliant)		
Generic I/O Port:	Four I/O ports, two for input and two for output Total 8-pin:		
Pin 1	Input Port (I+)	Pin 5	Output Port (I+)
Pin 2	Input Port (I-)	Pin 6	Output Port (I-)
Pin 3	Input Port (II+)	Pin 7	Output Port (II+)
Pin 4	Input Port (II-)	Pin 8	Output Port (II-)

### **Note:**

The output voltage is DC 5V and maximum current is 100mA.

LED Indicator: Power LED (Blue)  
LAN/WLAN Activity LED (Orange)

**Note:**

LED three mode setting can be changed by software. (Normal / Off / Dummy)

Power Supply: DC 5V/2.4A, switching type  
Power Communication: 6.5 Watt (1300mA x 5V)  
Slide Switch: LAN/LAN&WLAN/WLAN  
Antenna Connector: 2 connectors

**Communication Support**

Communication: 10/100Mbps Ethernet only  
10/100Mbps Ethernet and 802.11b wireless LAN.  
802.11b wireless LAN only  
Encryption: 64 bit, 128 bit or OFF  
Communication protocol: HTTP, FTP, TCP/IP, UDP, ARP,  
ICMP, BOOTP, RARP, DHCP, PPPoE

**Web Configuration Requirements:**

- Internet Explorer 5.0 or above or Netscape 6.0 or above
- CPU: Pentium II, 266 MHz or above
- Memory Size: 32 MB (64 MB recommended)
- VGA card resolution: 800x600 or above
- ActiveX Control requires IE4.0 or above (windows)
- Java Applet requires IE4.0 or above (Windows/Mac) or Netscape 4.0 or above (Windows/Mac/Linux)

**PC Requirements for IPView:**

- Windows XP, Windows 2000, Windows Me, Windows 98SE/98
- Pentium III, 450 MHz CPU or above
- Memory Size of 128 MB (256 MB recommended)
- VGA card resolution of 800x600 or above

**Operating environment**

Operating temperature: 5° ~ 50°  
Storage temperature: -25° ~ 50°  
Humidity: 5% ~ 95% non-condensing



**EMI & Safety**  
FCC, CE, VCCI

## **Technical Support**

D-Link provides free technical support for customers within the United States during the warranty period. U.S. customers can contact D-Link Technical Support through our web site, e-mail or by phone.

### **D-Link Technical Support over Telephone :**

1-800-758-5489

24 Hours a Day, 7 Days a Week

### **D-Link Technical Support over the Internet:**

[www.dlink.com](http://www.dlink.com)

[support@dlink.com](mailto:support@dlink.com)

If you are a customer residing outside of the United States, please refer to the list of D-Link locations that is included in the User' s Manual.

## **Registration**

Register your DCS-1000W at <http://support.dlink.com/registration/>