

# **D-Link™ DGS-1008D**

**8-Port 10/100/1000Mbps  
Gigabit Ethernet Switch**

## ***Manual***

Rev. 2.01

**D-Link®**

**Building Networks for People**



RECYCLABLE

**Information in this document is subject to change without notice.**

© 2003 D-Link Computer Corporation. All rights reserved.

Reproduction in any manner whatsoever without the written permission of D-Link Computer Corporation is strictly forbidden.

Trademarks used in this text: *D-Link* and the *D-LINK* logo are trademarks of D-Link Computer Corporation; *Microsoft* and *Windows* are registered trademarks of Microsoft Corporation.

Other trademarks and trade names may be used in this document to refer to either the entities claiming the marks and names or their products. D-Link Computer Corporation disclaims any proprietary interest in trademarks and trade names other than its own.

October 2003 P/N DGS1008D..B1

#### **FCC Warning**

This equipment has been tested and found to comply with the limits for a Class B digital device, pursuant to Part 15 of the FCC Rules. These limits are designed to provide reasonable protection against harmful interference when the equipment is operated in a commercial environment. This equipment generates, uses, and can radiate radio frequency energy and, if not installed and used in accordance with this user's guide, may cause harmful interference to radio communications. Operation of this equipment in a residential area is likely to cause harmful interference in which case the user will be required to correct the interference at his own expense.

#### **CE Mark Warning**

This is a Class B product. In a domestic environment, this product may cause radio interference in which case the user may be required to take adequate measures.

#### **Warnung!**

Dies ist ein Produkt der Klasse B. Im Wohnbereich kann dieses Produkt Funkstörereungen verursachen. In diesem Fall kann vom Benutzer verlangt werden, angemessene Massnahmen zu ergreifen.

#### **Precaución!**

Este es un producto de Clase B. En un entorno doméstico, puede causar interferencias de radio, en cuyo caso, puede requerirse al usuario para que adopte las medidas adecuadas.

#### **Attention!**

Ceci est un produit de classe B. Dans un environnement domestique, ce produit pourrait causer des interférences radio, auquel cas l'utilisateur devrait prendre les mesures adéquates.

#### **Attenzione!**

Il presente prodotto appartiene alla classe B. Se utilizzato in ambiente domestico il prodotto può causare interferenze radio, nel cui caso è possibile che l'utente debba assumere provvedimenti adeguati.

#### **VCCI Warning**

この装置は、クラスB情報技術装置です。この装置を家庭環境で使用すると電波妨害を引き起こすことがあります。この場合には使用者が適切な対策を講ずるよう要求されることがあります。

#### **BSMI Warning**

#### **警告使用者**

這是乙類的資訊產品，在居住的環境中使用時，可能會造成射頻干擾，在這種情況下使用者會被要求採取某些適當的對策。

## CONTENTS

<b>INTRODUCTION</b> .....	<b>1</b>
ETHERNET TECHNOLOGY.....	1
<i>Fast Ethernet Technology</i> .....	1
<i>Gigabit Ethernet Technology</i> .....	1
SWITCHING TECHNOLOGY.....	1
SWITCH DESCRIPTION.....	2
<i>Features</i> .....	2
FRONT-PANEL COMPONENTS.....	3
<i>LED Indicators</i> .....	3
REAR PANEL DESCRIPTION.....	5
<b>INSTALLATION</b> .....	<b>6</b>
<i>Package Contents</i> .....	6
BEFORE YOU CONNECT TO THE NETWORK.....	6
MOUNTING THE SWITCH ON A WALL.....	7
ATTACHING THE RUBBER FEET.....	7
PROVIDE FOR ADEQUATE VENTILATION.....	8
POWER ON.....	8
<i>Power Failure</i> .....	8
<b>CONNECTING THE SWITCH</b> .....	<b>9</b>
SWITCH TO END NODE.....	9
SWITCH TO HUB OR SWITCH.....	10
CONNECTING TO NETWORK BACKBONE OR SERVER.....	10
<b>TECHNICAL SPECIFICATIONS</b> .....	<b>11</b>
<b>GLOSSARY</b> .....	<b>12</b>
<b>WARRANTY AND REGISTRATION INFORMATION</b> .....	<b>18</b>
(ALL COUNTRIES AND REGIONS EXCLUDING USA).....	18

## Preface

The *DGS-1008D User's Guide* is divided into sections that describe the system installation and operating instructions with examples.

**Section 1, Introduction** - A description of the physical features of the switch, including LED indicators, ports and panel descriptions.

**Section 2, Installation** - A description of the physical installation of the switch including connecting the switch to the network and connecting stacked switch groups.

**Section 3, Connecting the Switch** - A description of how to connect your switch to an end node, hub, switch or backbone server.

**Appendix A, Technical Specifications** - The technical specifications of the DGS-1008D.

**Glossary** - Lists definitions for terms and acronyms used in this document.

**Index** - Index of relevant terms in the *DGS-1008D User's Guide*.

## Intended Readers

The *DGS-1008D User's Guide* contains information for setup and management and of the DGS-1008D switch. This guide is intended for network managers familiar with network management concepts and terminology.

## Notes, Notices, and Cautions

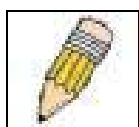

**NOTE:** A NOTE indicates important information that helps you make better use of your device.



**NOTICE:** A NOTICE indicates either potential damage to hardware or loss of data and tells you how to avoid the problem.



**CAUTION:** A CAUTION indicates a potential for property damage, personal injury, or death.

## Safety Instructions

Use the following safety guidelines to ensure your own personal safety and to help protect your system from potential damage. Throughout this safety section, the caution icon (  ) is used to indicate cautions and precautions that you need to review and follow.



### Safety Cautions

To reduce the risk of bodily injury, electrical shock, fire, and damage to the equipment, observe the following precautions.

Observe and follow service markings. Do not service any product except as explained in your system documentation. Opening or removing covers that are marked with the triangular symbol with a lightning bolt may expose you to electrical shock. Only a trained service technician should service components inside these compartments.

If any of the following conditions occur, unplug the product from the electrical outlet and replace the part or contact your trained service provider:

- The power cable, extension cable, or plug is damaged.
- An object has fallen into the product.
- The product has been exposed to water.
- The product has been dropped or damaged.
- The product does not operate correctly when you follow the operating instructions.
- Keep your system away from radiators and heat sources. Also, do not block cooling vents.
- Do not spill food or liquids on your system components, and never operate the product in a wet environment. If the system gets wet, see the appropriate section in your troubleshooting guide or contact your trained service provider.
- Do not push any objects into the openings of your system. Doing so can cause fire or electric shock by shorting out interior components.
- Use the product only with approved equipment.
- Allow the product to cool before removing covers or touching internal components.
- Operate the product only from the type of external power source indicated on the electrical ratings label. If you are not sure of the type of power source required, consult your service provider or local power company.
- To help avoid damaging your system, be sure the voltage selection switch (if provided) on the power supply is set to match the power available at your location:
  - 115 volts (V)/60 hertz (Hz) in most of North and South America and some Far Eastern countries such as South Korea and Taiwan
  - 100 V/50 Hz in eastern Japan and 100 V/60 Hz in western Japan
  - 230 V/50 Hz in most of Europe, the Middle East, and the Far East
- Also be sure that attached devices are electrically rated to operate with the power available in your location.

## Safety Instructions (continued)

- Use only approved power cable(s). If you have not been provided with a power cable for your system or for any AC-powered option intended for your system, purchase a power cable that is approved for use in your country. The power cable must be rated for the product and for the voltage and current marked on the product's electrical ratings label. The voltage and current rating of the cable should be greater than the ratings marked on the product.
- To help prevent electric shock, plug the system and peripheral power cables into properly grounded electrical outlets. These cables are equipped with three-prong plugs to help ensure proper grounding. Do not use adapter plugs or remove the grounding prong from a cable. If you must use an extension cable, use a 3-wire cable with properly grounded plugs.
- Observe extension cable and power strip ratings. Make sure that the total ampere rating of all products plugged into the extension cable or power strip does not exceed 80 percent of the ampere ratings limit for the extension cable or power strip.
- To help protect your system from sudden, transient increases and decreases in electrical power, use a surge suppressor, line conditioner, or uninterruptible power supply (UPS).
- Position system cables and power cables carefully; route cables so that they cannot be stepped on or tripped over. Be sure that nothing rests on any cables.
- Do not modify power cables or plugs. Consult a licensed electrician or your power company for site modifications. Always follow your local/national wiring rules.
- When connecting or disconnecting power to hot-pluggable power supplies, if offered with your system, observe the following guidelines:
  - Install the power supply before connecting the power cable to the power supply.
  - Unplug the power cable before removing the power supply.
  - If the system has multiple sources of power, disconnect power from the system by unplugging *all* power cables from the power supplies.
- Move products with care; ensure that all casters and/or stabilizers are firmly connected to the system. Avoid sudden stops and uneven surfaces.



## General Precautions for Rack-Mountable Products

Observe the following precautions for rack stability and safety. Also refer to the rack installation documentation accompanying the system and the rack for specific caution statements and procedures.

Systems are considered to be components in a rack. Thus, "component" refers to any system as well as to various peripherals or supporting hardware.



**CAUTION:** Installing systems in a rack without the front and side stabilizers installed could cause the rack to tip over, potentially resulting in bodily injury under certain circumstances. Therefore, always install the stabilizers before installing components in the rack.

After installing system/components in a rack, never pull more than one component out of the rack on its slide assemblies at one time. The weight of more than one extended component could cause the rack to tip over and may result in serious injury.

- Before working on the rack, make sure that the stabilizers are secured to the rack, extended to the floor, and that the full weight of the rack rests on the floor. Install front and side stabilizers on a single rack or front stabilizers for joined multiple racks before working on the rack.

## Safety Instructions (continued)

Always load the rack from the bottom up, and load the heaviest item in the rack first.

Make sure that the rack is level and stable before extending a component from the rack.

Use caution when pressing the component rail release latches and sliding a component into or out of a rack; the slide rails can pinch your fingers.

After a component is inserted into the rack, carefully extend the rail into a locking position, and then slide the component into the rack.

Do not overload the AC supply branch circuit that provides power to the rack. The total rack load should not exceed 80 percent of the branch circuit rating.

Ensure that proper airflow is provided to components in the rack.

Do not step on or stand on any component when servicing other components in a rack.



**NOTE:** A qualified electrician must perform all connections to DC power and to safety grounds. All electrical wiring must comply with applicable local or national codes and practices.



**CAUTION:** Never defeat the ground conductor or operate the equipment in the absence of a suitably installed ground conductor. Contact the appropriate electrical inspection authority or an electrician if you are uncertain that suitable grounding is available.



**CAUTION:** The system chassis must be positively grounded to the rack cabinet frame. Do not attempt to connect power to the system until grounding cables are connected. Completed power and safety ground wiring must be inspected by a qualified electrical inspector. An energy hazard will exist if the safety ground cable is omitted or disconnected.

## Protecting Against Electrostatic Discharge

Static electricity can harm delicate components inside your system. To prevent static damage, discharge static electricity from your body before you touch any of the electronic components, such as the microprocessor. You can do so by periodically touching an unpainted metal surface on the chassis.

You can also take the following steps to prevent damage from electrostatic discharge (ESD):

1. When unpacking a static-sensitive component from its shipping carton, do not remove the component from the antistatic packing material until you are ready to install the component in your system. Just before unwrapping the antistatic packaging, be sure to discharge static electricity from your body.
2. When transporting a sensitive component, first place it in an antistatic container or packaging.
3. Handle all sensitive components in a static-safe area. If possible, use antistatic floor pads and workbench pads and an antistatic grounding strap.

# SECTION 1

## Introduction

*Ethernet Technology*

*Switch Description*

*Features*

*Ports*

*Front-Panel Components*

## Ethernet Technology

### Fast Ethernet Technology

The growing importance of LANs and the increasing complexity of desktop computing applications are fueling the need for high performance networks. A number of high-speed LAN technologies are proposed to provide greater bandwidth and improve client/server response times. Among them, Fast Ethernet, or 100BASE-T, provides a non-disruptive, smooth evolution from 10BASE-T technology.

100Mbps Fast Ethernet is a standard specified by the IEEE 802.3 LAN committee. It is an extension of the 10Mbps Ethernet standard with the ability to transmit and receive data at 100Mbps, while maintaining the Carrier Sense Multiple Access with Collision Detection (CSMA/CD) Ethernet protocol.

### Gigabit Ethernet Technology

Gigabit Ethernet is an extension of IEEE 802.3 Ethernet utilizing the same packet structure, format, and support for CSMA/CD protocol, full duplex, flow control, and management objects, but with a tenfold increase in theoretical throughput over 100Mbps Fast Ethernet and a one hundred-fold increase over 10Mbps Ethernet. Since it is compatible with all 10Mbps and 100Mbps Ethernet environments, Gigabit Ethernet provides a straightforward upgrade without wasting a company's existing investment in hardware, software, and trained personnel.

The increased speed and extra bandwidth offered by Gigabit Ethernet is essential to coping with the network bottlenecks that frequently develop as computers and their busses get faster and more users use applications that generate more traffic. Upgrading key components, such as your backbone and servers to Gigabit Ethernet can greatly improve network response times as well as significantly speed up the traffic between your subnetworks.

Gigabit Ethernet enables fast optical fiber connections to support video conferencing, complex imaging, and similar data-intensive applications. Likewise, since data transfers occur 10 times faster than Fast Ethernet, servers outfitted with Gigabit Ethernet NIC's are able to perform 10 times the number of operations in the same amount of time.

In addition, the phenomenal bandwidth delivered by Gigabit Ethernet is the most cost-effective method to take advantage of today and tomorrow's rapidly improving switching and routing internetworking technologies.

## Switching Technology

Another key development pushing the limits of Ethernet technology is in the field of switching technology. A switch bridges Ethernet packets at the MAC address level of the Ethernet protocol transmitting among connected Ethernet or fast Ethernet LAN segments.

Switching is a cost-effective way of increasing the total network capacity available to users on a local area network. A switch increases capacity and decreases network loading by making it possible for a local area network to be divided into different *segments* which don't compete with each other for network transmission capacity, giving a decreased load on each.

The switch acts as a high-speed selective bridge between the individual segments. Traffic that needs to go from one segment to another (from one port to another) is automatically forwarded by the switch, without interfering



with any other segments (ports). This allows the total network capacity to be multiplied, while still maintaining the same network cabling and adapter cards.

For Fast Ethernet or Gigabit Ethernet networks, a switch is an effective way of eliminating problems of chaining hubs beyond the “two-repeater limit.” A switch can be used to split parts of the network into different collision domains, for example, making it possible to expand your Fast Ethernet network beyond the 205-meter network diameter limit for 100BASE-TX networks. Switches supporting both traditional 10Mbps Ethernet and 100Mbps Fast Ethernet are also ideal for bridging between existing 10Mbps networks and new 100Mbps networks.

Switching LAN technology is a marked improvement over the previous generation of network bridges, which were characterized by higher latencies. Routers have also been used to segment local area networks, but the cost of a router and the setup and maintenance required make routers relatively impractical. Today’s switches are an ideal solution to most kinds of local area network congestion problems.

## **Switch Description**

The DGS-1008D Switch module is equipped with eight ports providing dedicated 10, 100 or 1000 Mbps bandwidth. These ports can be used for connecting PCs, servers, and hubs. The eight multi-speed ports use standard twisted pair cabling and are ideal for segmenting networks into small, connected subnets. Each port can support up to 2000 Mbps of throughput in full-duplex mode. This stand-alone Switch enables the network to use some of the most demanding multimedia and imaging applications concurrently with other user applications without creating bottlenecks.

## **Features**

The DGS-1008D 8-Port 1000BASE-T Gigabit Ethernet Switch was designed for easy installation and high performance in an environment where traffic on the network and the number of users increase continuously.

- Eight (8) 1000BASE-T Gigabit Ethernet ports
- Cable Diagnostic function at Switch boot
- Supports Auto-Negotiation for 10/100/1000Mbps and duplex mode
- Supports Auto-MDIX for each port
- Support Full/Half duplex transfer mode for 10 and 100Mbps
- Support Full duplex transfer mode for 1000Mbps
- Full wire speed reception and transmission
- Store-and-Forward switching method
- Supports 4K absolute MAC addresses
- Supports 1M Bits RAM for data buffering
- Extensive front-panel diagnostic LEDs
- IEEE 802.3x flow control for full-duplex
- Back pressure flow control for half-duplex

## Front-Panel Components

The front panel of the Switch consists of LED indicators, 8(10/100/1000 Mbps) Ethernet ports.

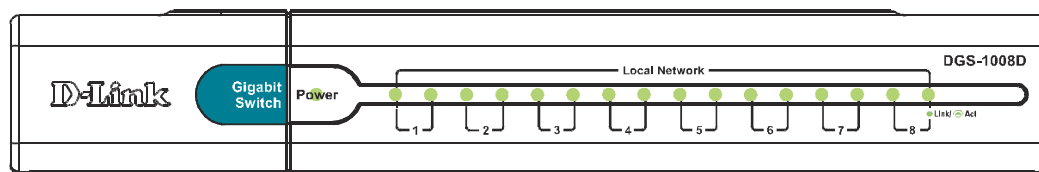

Figure 1-1. Front Panel View of the switch

Comprehensive LED indicators display the status of the switch and the network.

## LED Indicators

The LED indicators of the Switch include Power, 100/1000Mbps and Link/Act. The following shows the LED indicators for the Switch along with an explanation of each indicator.

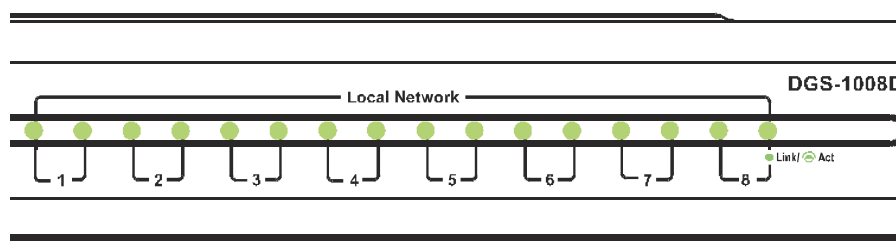

Figure 1-1. LED Indicators

### LED Indicators

Comprehensive LED indicators display the conditions of the Switch and status of the network. A description of these LED indicators follows (see LED Indicators). The LED indicators of the Switch include Power, Link/Act, 1000Mbps and 100Mbps.

- **Power Indicator**  
This green indicator illuminates when the Switch is receiving power.
- **Link / Act**  
This green indicator illuminates steadily when a port is connected to a station successfully and has a good link. The indicator will blink to indicate that a port is transmitting or receiving data on the network.
- **Speed — 100Mbps/amber; 1000Mbps/green; 10Mbps/off**  
This indicator is amber-colored when the port is connected to a 100Mbps Fast Ethernet station. It is green when the port is connected to a 1000Mbps Ethernet station. It is not illuminated when the port is connected to a 10Mbps Ethernet station.
- **Cable Diagnostic – LED Indications**  
When the Switch is booted, the Cable Diagnostic function is initialized and run. The Cable Diagnostic function will detect three common faults in an Ethernet cable connecting the Switch to a remote network device: an open circuit (a lack of continuity between the pins at each end of the Ethernet cable or a disconnected cable), a short circuit (two or more conductors short-circuited), and improper termination (a termination resistance greater than the specified 100 ohms). Any of these common cable faults will be detected by the Cable Diagnostic function and the LEDs will display the results of the Cable Diagnostic function as follows:

**Open, Short, or Improper Termination – Speed LED: Amber – Link/Act LED: Off**

**Cable connection good – Speed LED: Green – Link/Act LED: Off**

The Cable Diagnostic function operates only during the Switch boot (when the Switch is first powered on.)

The Cable Diagnostic first scans the eight Ethernet ports to determine if the Ethernet cable is in good working order. This process is indicated by the **Speed** LED blinking green for each of the eight ports – sequentially. The initial port scan takes about 10 seconds. If a cable fault is detected, it is indicated by the corresponding port's **Speed** LED glowing amber for 5 seconds – after the initial port scan. The Switch is then reset for normal operation. It takes about 2 seconds for the Switch to reset. The entire Cable Diagnostic process takes about 17 seconds from the time the Switch is booted. So, from the time power is first applied to the Switch, about 17 seconds is required before the Switch will begin normal operation.

There is no display of cable faults detected by the Cable Diagnostic function during the normal operation of the Switch.



**NOTE:** The Cable Diagnostic function does not support 10M/100M. If the port is connected to a 10M/100M device, see the Link LED to check if the cable is good or not.

## Rear Panel Description

### DC Power Jack:

Power is supplied through an external AC power adapter. Check the technical specification section for information about the AC power input voltage.

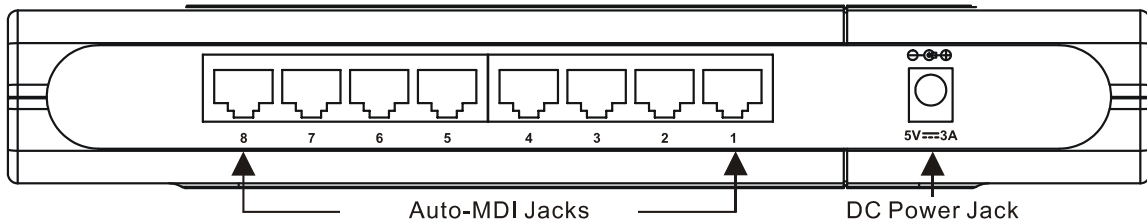

**Figure 1-2. Rear panel view of the Switch**

### 1000BASE-T Ports:

Eight (8) Gigabit Ethernet, Auto-Negotiating ports (10/100/1000Mbps)

Comprehensive LED indicators display the conditions of the Switch and status of the network.

## SECTION 2

# Installation

### *Package Contents*

### *Before You Connect to the Network*

### *Installing the Switch*

### *Power On*

## Package Contents

Open the shipping carton of the Switch and carefully unpack its contents. The carton should contain the following items:

- 1. One DGS-1008D 8-Port 1000BASE-T Gigabit Ethernet Switch
- 2. Four rubber feet with adhesive backing
- 3. One external power adapter
- 4. This manual
- 5. Wall-mounting Kit

If any item is found missing or damaged, please contact your local D-Link Reseller for replacement.

## Before You Connect to the Network

The site where you install the Switch may greatly affect its performance. Please follow these guidelines for setting up the Switch.

- Install the Switch on a sturdy, level surface that can support at least 3 kg of weight. Do not place heavy objects on the Switch.
- The power outlet should be within 1.82 meters (6 feet) of the Switch.
- Visually inspect the power cord and see that it is fully secured to the AC power port.
- Make sure that there is proper heat dissipation from and adequate ventilation around the switch. Leave at least 10 cm of space at the front and rear of the Switch for ventilation.
- Install the Switch in a fairly cool and dry place for the acceptable temperature and humidity operating ranges.
- Install the Switch in a site free from strong electromagnetic field generators (such as motors), vibration, dust, and direct exposure to sunlight.
- When installing the switch on a level surface, attach the rubber feet to the bottom of the device. The rubber feet cushion the Switch, protect the casing from scratches and prevent it from scratching other surfaces.

## Mounting the Switch on a Wall

The DGS-1008D can also be mounted on a wall. Two mounting slots are provided on the bottom of the switch for this purpose. Please make sure that the front panel is exposed in order to view the LEDs. Please refer to the illustration below:

### A.) Mounting on a cement wall

1. Mount the Nylon screw anchors into a cement wall.
2. Drive the T3 x 15L screws into the Nylon screw anchors.
3. Hook the mounting holes of the switch back on the screws; you have completed the wall-mount.

### B.) Mounting on a wood wall

1. Drive the T3 x 15 L screws into the wood wall.
2. Hook the mounting holes of the switch back on the screws; you have completed the wall-mount.

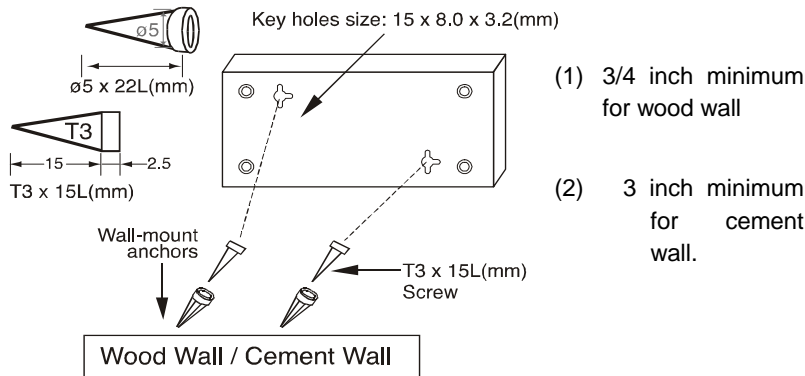

Figure 2-1. Mounting the Switch to a Wall

## Attaching the Rubber Feet

- Use rubber feet provided. Position and apply rubber feet to the underside of the DGS-1008D Switch.

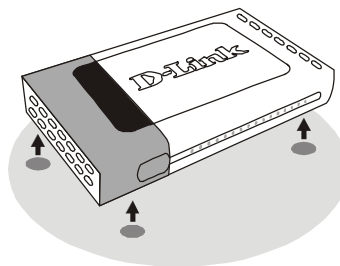

Figure 2-2. Attaching the Rubber Feet

## Provide for Adequate Ventilation



**CAUTION:** Do not place any device on top of Switch, or place the Switch on top of any device or object that will block the free flow of air through the ventilation slots on the sides, top, and bottom of the Switch's case. In addition, care should be taken not to locate the Switch next to, on top of, or underneath any device that generates a significant amount of heat. For the Switch to perform at its optimal level, the Switch must have adequate ventilation to prevent the Switch from overheating and becoming damaged.

## Power On

Plug one end of the AC to DC power converter into the power connector of the Switch and the other end into the local power source outlet.

After the Switch is powered on, the LED indicators will momentarily blink. This blinking of the LED indicators represents a reset of the system.

## Power Failure

As a precaution, in the event of a power failure, unplug the Switch. When power is resumed, plug the Switch back in.

## Section 3

### Connecting The Switch

- Switch To End Node*
- Switch To Hub or Switch*
- Connecting To a Server*



**NOTE:** All 8 high-performance NWay Ethernet ports can support both MDI-II and MDI-X connections.

#### Switch To End Node

End nodes include PCs outfitted with a 10, 100 or 1000 Mbps RJ-45 Ethernet/Fast Ethernet Network Interface Card (NIC) and most routers.

An end node can be connected to the Switch via a twisted-pair Category 3, 4, or 5 UTP/STP cable. The end node can be connected to any of the ports of the Switch.

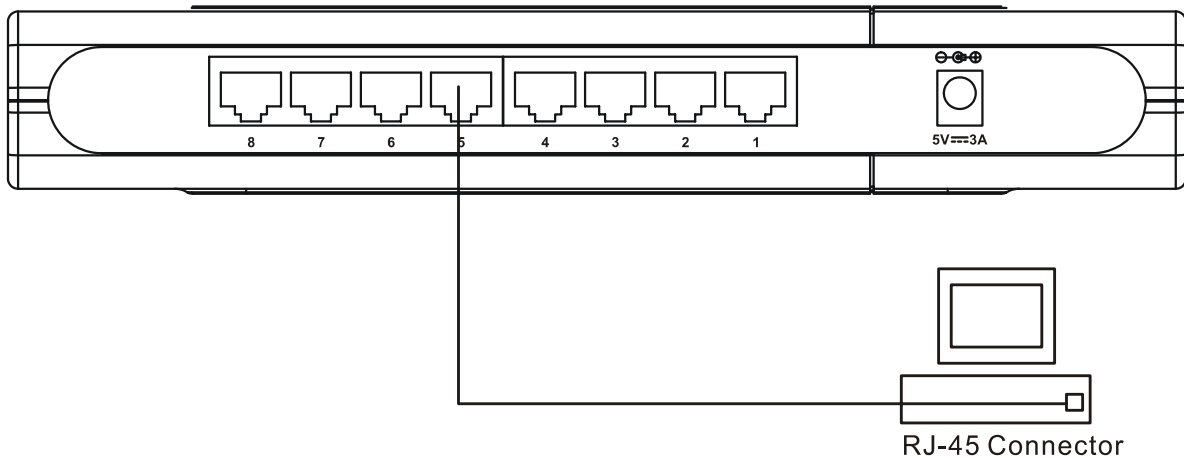

**Figure 3-1. Switch connected to an end node**

The **Link/Act** LEDs for each UTP port light green when the link is valid. The LED over the port label indicates a port speed of either 10/100 Mbps or 1000Mbps. A blinking LED on the bottom indicates packet activity on that port.



## Switch to Hub or Switch

These connections can be accomplished in a number of ways using a normal cable

- A 10BASE-T hub or switch can be connected to the Switch via a twisted-pair Category 3, 4, 5, or 5e UTP/STP cable.
- A 100BASE-TX hub or switch can be connected to the Switch via a twisted -pair Category 5 UTP/STP cable.
- A 1000BASE-T switch can be connected to the Switch via a twisted -pair Category 5e UTP/STP cable.

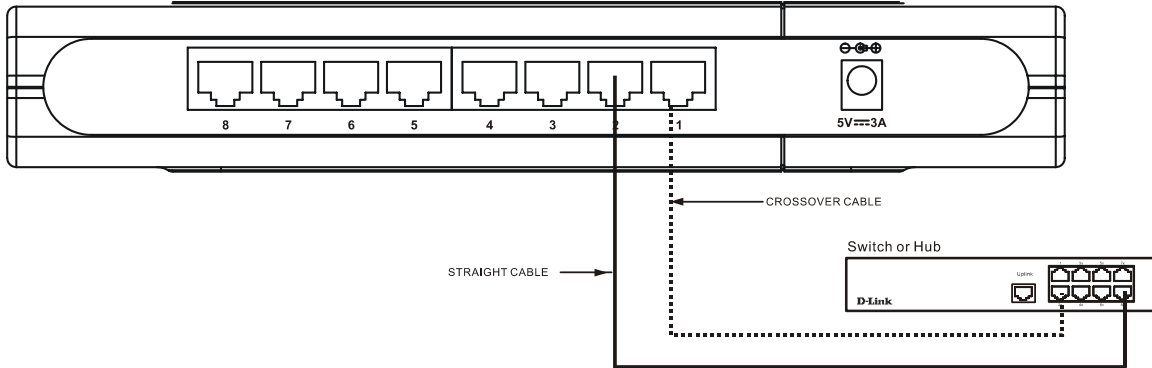

**Figure 3-2. Switch connected to a port on a hub or switch using either a straight or crossover cable—any normal cable is fine**

## Connecting To Network Backbone or Server

Any of the eight Gigabit Ethernet ports are ideal for uplinking to a network backbone or network server. These ports operate at 1000 Mbps in full-duplex mode.

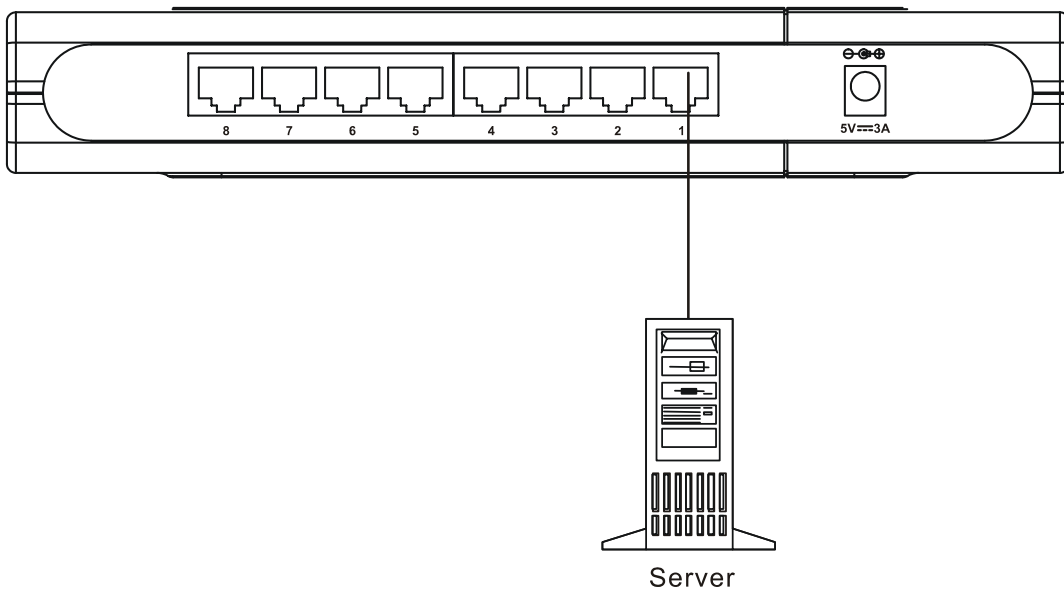

**Figure 3-3. Connection to a Server**

## Appendix A

### Technical Specifications

General	
Standards:	IEEE 802.3ab 1000BASE-T IEEE 802.3u 100BASE-TX IEEE 802.3 10BASE-T IEEE 802.3x Flow Control
Protocol:	CSMA/CD
Data Transfer Rate:	Ethernet: 10Mbps (Half-duplex) 20Mbps (Full-duplex) Fast Ethernet: 100Mbps (Half-duplex) 200Mbps (Full-duplex) Gigabit Ethernet: 2000Mbps (Full-duplex)
Topology:	Star
Network Cables:	Ethernet: 2-pair UTP Cat. 3,4,5, Unshield Twisted Pair (UTP )Cable Fast Ethernet: 2-pair UTP Cat. 5, Unshield Twisted Pair (UTP )Cable Gigabit Ethernet: 4-pair UTP Cat. 5e, Unshield Twisted Pair (UTP )Cable
Number of Ports:	Eight (8) 10/100/1000BASE-T Gigabit Ethernet ports

Physical and Environmental	
DC Inputs:	5V / 3A
Power Consumption:	11 watts maximum
Operating Temperature:	32°F ~ 131F ° (0 °C ~ 55 )
Storage Temperature:	14°F ~ 158°F (-10°C ~ 70°C)
Humidity:	5% ~ 95% RH, non-condensing
Dimensions:	9.25 in. x 6.37 in. x 1.4 in. (235mm x 161.9mm x 35.6mm)
EMI	FCC Class B, CE Mark Class B
Safety:	CSA International
Performance	
Transmission Method:	Store-and-forward
RAM Buffer:	1 M Bytes per device
Filtering Address Table:	4K MAC address per device
Packet Filtering/ Forwarding Rate:	Full wire speed
MAC Address Learning:	Self-learning, auto-aging

## Glossary

---

**1000BASE-LX** a short laser wavelength on multimode fiber optic cable for a maximum length of 550 meters

**1000BASE-SX** a long wavelength for a "long haul" fiber optic cable for a maximum length of 10 kilometers

**100BASE-FX** 100Mbps Ethernet implementation over fiber.

**100BASE-TX** 100Mbps Ethernet implementation over Category 5 and Type 1 Twisted Pair cabling.

**10BASE-T** The IEEE 802.3 specification for Ethernet over Unshielded Twisted Pair (UTP) cabling.

**ageing** The automatic removal of dynamic entries from the Switch Database which have timed-out and are no longer valid.

**ATM** Asynchronous Transfer Mode. A connection oriented transmission protocol based on fixed length cells (packets). ATM is designed to carry a complete range of user traffic, including voice, data and video signals.

**auto-negotiation** A feature on a port which allows it to advertise its capabilities for speed, duplex and flow control. When connected to an end station that also supports auto-negotiation, the link can self-detect its optimum operating setup.

**backbone port** A port which does not learn device addresses, and which receives all frames with an unknown address. Backbone ports are normally used to connect the Switch to the backbone of your network. Note that backbone ports were formerly known as designated downlink ports.

**backbone** The part of a network used as the primary path for transporting traffic between network segments.

**bandwidth** Information capacity, measured in bits per second, that a channel can transmit. The bandwidth of Ethernet is 10Mbps, the bandwidth of Fast Ethernet is 100Mbps.

**baud rate** The switching speed of a line. Also known as *line speed*.

between network segments.

**BOOTP** The BOOTP protocol allows you to automatically map an IP address to a given MAC address each time a device is started. In addition, the protocol can assign the subnet mask and default gateway to a device.

**bridge** A device that interconnects local or remote networks no matter what higher level protocols are involved. Bridges form a single logical network, centralizing network administration.

**broadcast** A message sent to all destination devices on the network.

**broadcast storm** Multiple simultaneous broadcasts that typically absorb available network bandwidth and can cause network failure.

**console port** The port on the Switch accepting a terminal or modem connector. It changes the parallel arrangement of data within computers to the serial form used on data transmission links. This port is most often used for dedicated local management.

**CSMA/CD** Channel access method used by Ethernet and IEEE 802.3 standards in which devices transmit only after finding the data channel clear for some period of time. When two devices transmit simultaneously, a collision occurs and the colliding devices delay their retransmissions for a random amount of time.

**data center switching** The point of aggregation within a corporate network where a switch provides high-performance access to server farms, a high-speed backbone connection and a control point for network management and security.

**Ethernet** A LAN specification developed jointly by Xerox, Intel and Digital Equipment Corporation. Ethernet networks operate at 10Mbps using CSMA/CD to run over cabling.

**Fast Ethernet** 100Mbps technology based on the Ethernet/CD network access method.

**Flow Control (IEEE 802.3z)** A means of holding packets back at the transmit port of the connected end station. Prevents packet loss at a congested switch port.

**forwarding** The process of sending a packet toward its destination by an internetworking device.

**full duplex** A system that allows packets to be transmitted and received at the same time and, in effect, doubles the potential throughput of a link.

**half duplex** A system that allows packets to be transmitted and received, but not at the same time. Contrast with *full duplex*.

**IP address** Internet Protocol address. A unique identifier for a device attached to a network using TCP/IP. The address is written as four octets separated with full-stops (periods), and is made up of a network section, an optional subnet section and a host section.

**IPX** Internetwork Packet Exchange. A protocol allowing communication in a NetWare network.

**LAN** Local Area Network. A network of connected computing resources (such as PCs, printers, servers) covering a relatively small geographic area (usually not larger than a floor or building). Characterized by high data rates and low error rates.

**latency** The delay between the time a device receives a packet and the time the packet is forwarded out of the destination port.

**line speed** See *baud rate*.

**main port** The port in a resilient link that carries data traffic in normal operating conditions.

**MDI** Medium Dependent Interface. An Ethernet port connection where the transmitter of one device is connected to the receiver of another device.

**MDI-X** Medium Dependent Interface Cross-over. An Ethernet port connection where the internal transmit and receive lines are crossed.

**MIB** Management Information Base. Stores a device's management characteristics and parameters. MIBs are used by the Simple Network Management Protocol (SNMP) to contain attributes of their managed systems. The Switch contains its own internal MIB.

**multicast** Single packets copied to a specific subset of network addresses. These addresses are specified in the destination-address field of the packet.

**protocol** A set of rules for communication between devices on a network. The rules dictate format, timing, sequencing and error control.

**resilient link** A pair of ports that can be configured so that one will take over data transmission should the other fail. See also *main port* and *standby port*.

**RJ-45** Standard 8-wire connectors for IEEE 802.3 10BASE-T networks.

**RMON** Remote Monitoring. Subset of SNMP MIB II which allows monitoring and management capabilities by addressing up to ten different groups of information.

**RPS** Redundant Power System. A device that provides a backup source of power when connected to the Switch.

**server farm** A cluster of servers in a centralized location serving a large user population.

**SLIP** Serial Line Internet Protocol. A protocol which allows IP to run over a serial line connection.

**SNMP** Simple Network Management Protocol. A protocol originally designed to be used in managing TCP/IP internets. SNMP is presently implemented on a wide range of computers and networking equipment and may be used to manage many aspects of network and end station operation.

**Spanning Tree Protocol (STP)** A bridge-based system for providing fault tolerance on networks. STP works by allowing you to implement parallel paths for network traffic, and ensure that redundant paths are disabled when the main paths are operational and enabled if the main paths fail.

**stack** A group of network devices that are integrated to form a single logical device.

**standby port** The port in a resilient link that will take over data transmission if the main port in the link fails.

**switch** A device which filters, forwards and floods packets based on the packet's destination address. The switch learns the addresses associated with each switch port and builds tables based on this information to be used for the switching decision.

**TCP/IP** A layered set of communications protocols providing Telnet terminal emulation, FTP file transfer, and other services for communication among a wide range of computer equipment.

**Telnet** A TCP/IP application protocol that provides virtual terminal service, letting a user log in to another computer system and access a host as if the user were connected directly to the host.

**TFTP** Trivial File Transfer Protocol. Allows you to transfer files (such as software upgrades) from a remote device using your switch's local management capabilities.

**UDP** User Datagram Protocol. An Internet standard protocol that allows an application program on one device to send a datagram to an application program on another device.

**VLAN** Virtual LAN. A group of location- and topology-independent devices that communicate as if they are on a common physical LAN.

**VL**T Virtual LAN Trunk. A Switch-to-Switch link which carries traffic for all the VLANs on each Switch.

**VT100** A type of terminal which uses ASCII characters. VT100 screens have a text-based appearance.

Subject to the terms and conditions set forth herein, D-Link Systems, Inc. ("D-Link") provides this Limited warranty for its product only to the person or entity that originally purchased the product from:

- D-Link or its authorized reseller or distributor and
- Products purchased and delivered within the fifty states of the United States, the District of Columbia, U.S. Possessions or Protectorates, U.S. Military Installations, addresses with an APO or FPO.

**Limited Warranty:** D-Link warrants that the hardware portion of the D-Link products described below will be free from material defects in workmanship and materials from the date of original retail purchase of the product, for the period set forth below applicable to the product type ("Warranty Period"), except as otherwise stated herein.

Limited Lifetime Warranty for the Product(s) is defined as follows:

- Hardware for as long as the original customer/end user owns the product, or five years after product discontinuance, whichever occurs first (excluding power supplies and fans)
- Power Supplies and Fans Three (3) Year
- Spare parts and spare kits Ninety (90) days

D-Link's sole obligation shall be to repair or replace the defective Hardware during the Warranty Period at no charge to the original owner or to refund at D-Link's sole discretion. Such repair or replacement will be rendered by D-Link at an Authorized D-Link Service Office. The replacement Hardware need not be new or have an identical make, model or part. D-Link may in its sole discretion replace the defective Hardware (or any part thereof) with any reconditioned product that D-Link reasonably determines is substantially equivalent (or superior) in all material respects to the defective Hardware. Repaired or replacement Hardware will be warranted for the remainder of the original Warranty Period from the date of original retail purchase. If a material defect is incapable of correction, or if D-Link determines in its sole discretion that it is not practical to repair or replace the defective Hardware, the price paid by the original purchaser for the defective Hardware will be refunded by D-Link upon return to D-Link of the defective Hardware. All Hardware (or part thereof) that is replaced by D-Link, or for which the purchase price is refunded, shall become the property of D-Link upon replacement or refund.

**Limited Software Warranty:** D-Link warrants that the software portion of the product ("Software") will substantially conform to D-Link's then current functional specifications for the Software, as set forth in the applicable documentation, from the date of original retail purchase of the Software for a period of ninety (90) days ("Warranty Period"), provided that the Software is properly installed on approved hardware and operated as contemplated in its documentation. D-Link further warrants that, during the Warranty Period, the magnetic media on which D-Link delivers the Software will be free of physical defects. D-Link's sole obligation shall be to replace the non-conforming Software (or defective media) with software that substantially conforms to D-Link's functional specifications for the Software or to refund at D-Link's sole discretion. Except as otherwise agreed by D-Link in writing, the replacement Software is provided only to the original licensee, and is subject to the terms and conditions of the license granted by D-Link for the Software. Software will be warranted for the remainder of the original Warranty Period from the date of original retail purchase. If a material non-conformance is incapable of correction, or if D-Link determines in its sole discretion that it is not practical to replace the non-conforming Software, the price paid by the original licensee for the non-conforming Software will be refunded by D-Link; provided that the non-conforming Software (and all copies thereof) is first returned to D-Link. The license granted respecting any Software for which a refund is given automatically terminates.

**Non-Applicability of Warranty:** The Limited Warranty provided hereunder for hardware and software of D-Link's products will not be applied to and does not cover any refurbished product and any product purchased through the inventory clearance or liquidation sale or other sales in which D-Link, the sellers, or the liquidators expressly disclaim their warranty obligation pertaining to the product and in that case, the product is being sold "As-Is" without any warranty whatsoever including, without limitation, the Limited Warranty as described herein, notwithstanding anything stated herein to the contrary.

**Submitting A Claim:** The customer shall return the product to the original purchase point based on its return policy. In case the return policy period has expired and the product is within warranty, the customer shall submit a claim to D-Link as outlined below:

- The customer must submit with the product as part of the claim a written description of the Hardware defect or Software nonconformance in sufficient detail to allow D-Link to confirm the same.
- The original product owner must obtain a Return Material Authorization ("RMA") number from the Authorized D-Link Service Office and, if requested, provide written proof of purchase of the product (such as a copy of the dated purchase invoice for the product) before the warranty service is provided.
- After an RMA number is issued, the defective product must be packaged securely in the original or other suitable shipping package to ensure that it will not be damaged in transit, and the RMA number must be prominently marked on the outside of the package. Do not include any manuals or accessories in the shipping package. D-Link will only replace the defective portion of the Product and will not ship back any accessories.

- The customer is responsible for all in-bound shipping charges to D-Link. No Cash on Delivery ("COD") is allowed. Products sent COD will either be rejected by D-Link or become the property of D-Link. Products shall be fully insured by the customer and shipped to **D-Link Systems, Inc., 17595 Mt.Herrmann Fountain Valley, CA 92708-4160**. D-Link will not be held responsible for any packages that are lost in transit to D-Link. The repaired or replaced packages will be shipped to the customer via UPS Ground or any common carrier selected by D-Link, with shipping charges prepaid. Expedited shipping is available if shipping charges are prepaid by the customer and upon request.

D-Link may reject or return any product that is not packaged and shipped in strict compliance with the foregoing requirements, or for which an RMA number is not visible from the outside of the package. The product owner agrees to pay D-Link's reasonable handling and return shipping charges for any product that is not packaged and shipped in accordance with the foregoing requirements, or that is determined by D-Link not to be defective or non-conforming.

**What Is Not Covered:** This limited warranty provided by D-Link does not cover: Products, if in D-Link's judgment, have been subjected to abuse, accident, alteration, modification, tampering, negligence, misuse, faulty installation, lack of reasonable care, repair or service in any way that is not contemplated in the documentation for the product, or if the model or serial number has been altered, tampered with, defaced or removed; Initial installation, installation and removal of the product for repair, and shipping costs; Operational adjustments covered in the operating manual for the product, and normal maintenance; Damage that occurs in shipment, due to act of God, failures due to power surge, and cosmetic damage; Any hardware, software, firmware or other products or services provided by anyone other than D-Link; Products that have been purchased from inventory clearance or liquidation sales or other sales in which D-Link, the sellers, or the liquidators expressly disclaim their warranty obligation pertaining to the product. Repair by anyone other than D-Link or an Authorized D-Link Service Office will void this Warranty.

**Disclaimer of Other Warranties:** EXCEPT FOR THE LIMITED WARRANTY SPECIFIED HEREIN, THE PRODUCT IS PROVIDED "AS-IS" WITHOUT ANY WARRANTY OF ANY KIND WHATSOEVER INCLUDING, WITHOUT LIMITATION, ANY WARRANTY OF MERCHANTABILITY, FITNESS FOR A PARTICULAR PURPOSE AND NON-INFRINGEMENT. IF ANY IMPLIED WARRANTY CANNOT BE DISCLAIMED IN ANY TERRITORY WHERE A PRODUCT IS SOLD, THE DURATION OF SUCH IMPLIED WARRANTY SHALL BE LIMITED TO NINETY (90) DAYS. EXCEPT AS EXPRESSLY COVERED UNDER THE LIMITED WARRANTY PROVIDED HEREIN, THE ENTIRE RISK AS TO THE QUALITY, SELECTION AND PERFORMANCE OF THE PRODUCT IS WITH THE PURCHASER OF THE PRODUCT.

**Limitation of Liability:** TO THE MAXIMUM EXTENT PERMITTED BY LAW, D-LINK IS NOT LIABLE UNDER ANY CONTRACT, NEGLIGENCE, STRICT LIABILITY OR OTHER LEGAL OR EQUITABLE THEORY FOR ANY LOSS OF USE OF THE PRODUCT, INCONVENIENCE OR DAMAGES OF ANY CHARACTER, WHETHER DIRECT, SPECIAL, INCIDENTAL OR CONSEQUENTIAL (INCLUDING, BUT NOT LIMITED TO, DAMAGES FOR LOSS OF GOODWILL, LOSS OF REVENUE OR PROFIT, WORK STOPPAGE, COMPUTER FAILURE OR MALFUNCTION, FAILURE OF OTHER EQUIPMENT OR COMPUTER PROGRAMS TO WHICH D-LINK'S PRODUCT IS CONNECTED WITH, LOSS OF INFORMATION OR DATA CONTAINED IN, STORED ON, OR INTEGRATED WITH ANY PRODUCT RETURNED TO D-LINK FOR WARRANTY SERVICE) RESULTING FROM THE USE OF THE PRODUCT, RELATING TO WARRANTY SERVICE, OR ARISING OUT OF ANY BREACH OF THIS LIMITED WARRANTY, EVEN IF D-LINK HAS BEEN ADVISED OF THE POSSIBILITY OF SUCH DAMAGES. THE SOLE REMEDY FOR A BREACH OF THE FOREGOING LIMITED WARRANTY IS REPAIR, REPLACEMENT OR REFUND OF THE DEFECTIVE OR NON-CONFORMING PRODUCT. THE MAXIMUM LIABILITY OF D-LINK UNDER THIS WARRANTY IS LIMITED TO THE PURCHASE PRICE OF THE PRODUCT COVERED BY THE WARRANTY. THE FOREGOING EXPRESS WRITTEN WARRANTIES AND REMEDIES ARE EXCLUSIVE AND ARE IN LIEU OF ANY OTHER WARRANTIES OR REMEDIES, EXPRESS, IMPLIED OR STATUTORY

**Governing Law:** This Limited Warranty shall be governed by the laws of the State of California. Some states do not allow exclusion or limitation of incidental or consequential damages, or limitations on how long an implied warranty lasts, so the foregoing limitations and exclusions may not apply. This limited warranty provides specific legal rights and the product owner may also have other rights which vary from state to state.

**Trademarks:** D-Link is a registered trademark of D-Link Systems, Inc. Other trademarks or registered trademarks are the property of their respective manufacturers or owners.

**Copyright Statement:** No part of this publication or documentation accompanying this Product may be reproduced in any form or by any means or used to make any derivative such as translation, transformation, or adaptation without permission from D-Link Corporation/D-Link Systems, Inc., as stipulated by the United States Copyright Act of 1976. Contents are subject to change without prior notice. Copyright® 2002 by D-Link Corporation/D-Link Systems, Inc. All rights reserved.

**CE Mark Warning:** This is a Class B product. In a domestic environment, this product may cause radio interference, in which case the user may be required to take adequate measures.

**FCC Statement:** This equipment has been tested and found to comply with the limits for a Class B digital device, pursuant to part 15 of the FCC Rules. These limits are designed to provide reasonable protection against harmful interference in a residential installation. This equipment generates, uses, and can radiate radio frequency energy and, if not installed and used in accordance with the instructions, may cause harmful interference to radio communication. However, there is no guarantee that interference will not occur in a particular installation. If this equipment does cause harmful interference to radio or television reception, which can be determined by turning the equipment off and on, the user is encouraged to try to correct the interference by one or more of the following measures:

- Reorient or relocate the receiving antenna.
- Increase the separation between the equipment and receiver.
- Connect the equipment into an outlet on a circuit different from that to which the receiver is connected.
- Consult the dealer or an experienced radio/TV technician for help.





# Warranty and Registration Information

## (All countries and regions excluding USA)

### Wichtige Sicherheitshinweise

1. Bitte lesen Sie sich diese Hinweise sorgfältig durch.
2. Heben Sie diese Anleitung für den spätern Gebrauch auf.
3. Vor jedem Reinigen ist das Gerät vom Stromnetz zu trennen. Verwenden Sie keine Flüssig- oder Aerosolreiniger. Am besten dient ein angefeuchtetes Tuch zur Reinigung.
4. Um eine Beschädigung des Gerätes zu vermeiden sollten Sie nur Zubehörteile verwenden, die vom Hersteller zugelassen sind.
5. Das Gerät ist vor Feuchtigkeit zu schützen.
6. Bei der Aufstellung des Gerätes ist auf sicheren Stand zu achten. Ein Kippen oder Fallen könnte Verletzungen hervorrufen. Verwenden Sie nur sichere Standorte und beachten Sie die Aufstellhinweise des Herstellers.
7. Die Belüftungsöffnungen dienen zur Luftzirkulation die das Gerät vor Überhitzung schützt. Sorgen Sie dafür, daß diese Öffnungen nicht abgedeckt werden.
8. Beachten Sie beim Anschluß an das Stromnetz die Anschlußwerte.
9. Die Netzanschlußsteckdose muß aus Gründen der elektrischen Sicherheit einen Schutzleiterkontakt haben.
10. Verlegen Sie die Netzanschlußleitung so, daß niemand darüber fallen kann. Es sollte auch nichts auf der Leitung abgestellt werden.
11. Alle Hinweise und Warnungen die sich am Geräten befinden sind zu beachten.
12. Wird das Gerät über einen längeren Zeitraum nicht benutzt, sollten Sie es vom Stromnetz trennen. Somit wird im Falle einer Überspannung eine Beschädigung vermieden.
13. Durch die Lüftungsöffnungen dürfen niemals Gegenstände oder Flüssigkeiten in das Gerät gelangen. Dies könnte einen Brand bzw. Elektrischen Schlag auslösen.
14. Öffnen Sie niemals das Gerät. Das Gerät darf aus Gründen der elektrischen Sicherheit nur von autorisiertem Servicepersonal geöffnet werden.
15. Wenn folgende Situationen auftreten ist das Gerät vom Stromnetz zu trennen und von einer qualifizierten Servicestelle zu überprüfen:
  - a. Netzkabel oder Netzstecker sind beschädigt.
  - b. Flüssigkeit ist in das Gerät eingedrungen.
  - c. Das Gerät war Feuchtigkeit ausgesetzt.
  - d. Wenn das Gerät nicht der Bedienungsanleitung entsprechend funktioniert oder Sie mit Hilfe dieser Anleitung keine Verbesserung erzielen.
  - e. Das Gerät ist gefallen und/oder das Gehäuse ist beschädigt.
  - f. Wenn das Gerät deutliche Anzeichen eines Defektes aufweist.
16. Bei Reparaturen dürfen nur Originalersatzteile bzw. den Originalteilen entsprechende Teile verwendet werden. Der Einsatz von ungeeigneten Ersatzteilen kann eine weitere Beschädigung hervorrufen.
17. Wenden Sie sich mit allen Fragen die Service und Reparatur betreffen an Ihren Servicepartner. Somit stellen Sie die Betriebssicherheit des Gerätes sicher.
18. Zum Netzanschluß dieses Gerätes ist eine geprüfte Leitung zu verwenden, Für einen Nennstrom bis 6A und einem Gerätegewicht größer 3kg ist eine Leitung nicht leichter als H05VV-F, 3G, 0.75mm<sup>2</sup> einzusetzen.

### WARRANTIES EXCLUSIVE

IF THE D-LINK PRODUCT DOES NOT OPERATE AS WARRANTED ABOVE, THE CUSTOMER'S SOLE REMEDY SHALL BE, AT D-LINK'S OPTION, REPAIR OR REPLACEMENT. THE FOREGOING WARRANTIES AND REMEDIES ARE EXCLUSIVE AND ARE IN LIEU OF ALL OTHER WARRANTIES, EXPRESSED OR IMPLIED, EITHER IN FACT OR BY OPERATION OF LAW, STATUTORY OR OTHERWISE, INCLUDING WARRANTIES OF MERCHANTABILITY AND FITNESS FOR A PARTICULAR PURPOSE. D-LINK NEITHER ASSUMES NOR AUTHORIZES ANY OTHER PERSON TO ASSUME FOR IT ANY OTHER LIABILITY IN CONNECTION WITH THE SALE, INSTALLATION MAINTENANCE OR USE OF D-LINK'S PRODUCTS.

D-LINK SHALL NOT BE LIABLE UNDER THIS WARRANTY IF ITS TESTING AND EXAMINATION DISCLOSE THAT THE ALLEGED DEFECT IN THE PRODUCT DOES NOT EXIST OR WAS CAUSED BY THE CUSTOMER'S OR ANY THIRD PERSON'S MISUSE, NEGLIGENCE, IMPROPER INSTALLATION OR TESTING, UNAUTHORIZED ATTEMPTS TO REPAIR, OR ANY OTHER CAUSE BEYOND THE RANGE OF THE INTENDED USE, OR BY ACCIDENT, FIRE, LIGHTNING OR OTHER HAZARD.

### LIMITATION OF LIABILITY

IN NO EVENT WILL D-LINK BE LIABLE FOR ANY DAMAGES, INCLUDING LOSS OF DATA, LOSS OF PROFITS, COST OF COVER OR OTHER INCIDENTAL, CONSEQUENTIAL OR INDIRECT DAMAGES ARISING OUT THE INSTALLATION, MAINTENANCE, USE, PERFORMANCE, FAILURE OR INTERRUPTION OF A D- LINK PRODUCT, HOWEVER CAUSED AND ON ANY THEORY OF LIABILITY. THIS LIMITATION WILL APPLY EVEN IF D-LINK HAS BEEN ADVISED OF THE POSSIBILITY OF SUCH DAMAGE.

IF YOU PURCHASED A D-LINK PRODUCT IN THE UNITED STATES, SOME STATES DO NOT ALLOW THE LIMITATION OR EXCLUSION OF LIABILITY FOR INCIDENTAL OR CONSEQUENTIAL DAMAGES, SO THE ABOVE LIMITATION MAY NOT APPLY TO YOU.

## **Limited Warranty**

### **Hardware:**

D-Link warrants each of its hardware products to be free from defects in workmanship and materials under normal use and service for a period commencing on the date of purchase from D-Link or its Authorized Reseller and extending for the length of time stipulated by the Authorized Reseller or D-Link Branch Office nearest to the place of purchase.

This Warranty applies on the condition that the product Registration Card is filled out and returned to a D-Link office within ninety (90) days of purchase. A list of D-Link offices is provided at the back of this manual, together with a copy of the Registration Card.

If the product proves defective within the applicable warranty period, D-Link will provide repair or replacement of the product. D-Link shall have the sole discretion whether to repair or replace, and replacement product may be new or reconditioned. Replacement product shall be of equivalent or better specifications, relative to the defective product, but need not be identical. Any product or part repaired by D-Link pursuant to this warranty shall have a warranty period of not less than 90 days, from date of such repair, irrespective of any earlier expiration of original warranty period. When D-Link provides replacement, then the defective product becomes the property of D-Link.

Warranty service may be obtained by contacting a D-Link office within the applicable warranty period, and requesting a Return Material Authorization (RMA) number. If a Registration Card for the product in question has not been returned to D-Link, then a proof of purchase (such as a copy of the dated purchase invoice) must be provided. If Purchaser's circumstances require special handling of warranty correction, then at the time of requesting RMA number, Purchaser may also propose special procedure as may be suitable to the case.

After an RMA number is issued, the defective product must be packaged securely in the original or other suitable shipping package to ensure that it will not be damaged in transit, and the RMA number must be prominently marked on the outside of the package. The package must be mailed or otherwise shipped to D-Link with all costs of mailing/shipping/insurance prepaid. D-Link shall never be responsible for any software, firmware, information, or memory data of Purchaser contained in, stored on, or integrated with any product returned to D-Link pursuant to this warranty.

Any package returned to D-Link without an RMA number will be rejected and shipped back to Purchaser at Purchaser's expense, and D-Link reserves the right in such a case to levy a reasonable handling charge in addition mailing or shipping costs.

### **Software:**

Warranty service for software products may be obtained by contacting a D-Link office within the applicable warranty period. A list of D-Link offices is provided at the back of this manual, together with a copy of the Registration Card. If a Registration Card for the product in question has not been returned to a D-Link office, then a proof of purchase (such as a copy of the dated purchase invoice) must be provided when requesting warranty service. The term "purchase" in this software warranty refers to the purchase transaction and resulting license to use such software.

D-Link warrants that its software products will perform in substantial conformance with the applicable product documentation provided by D-Link with such software product, for a period of ninety (90) days from the date of purchase from D-Link or its Authorized Reseller. D-Link warrants the magnetic media, on which D-Link provides its software product, against failure during the same warranty period. This warranty applies to purchased software, and to replacement software provided by D-Link pursuant to this warranty, but shall not apply to any update or replacement which may be provided for download via the Internet, or to any update which may otherwise be provided free of charge.

D-Link's sole obligation under this software warranty shall be to replace any defective software product with product which substantially conforms to D-Link's applicable product documentation. Purchaser assumes responsibility for the selection of appropriate application and system/platform software and associated reference materials. D-Link makes no warranty that its software products will work in combination with any hardware, or any application or system/platform software product provided by any third party, excepting only such products as are expressly represented, in D-Link's applicable product documentation as being compatible. D-Link's obligation under this warranty shall be a reasonable effort to provide compatibility, but D-Link shall have no obligation to provide compatibility when there is fault in the third-party hardware or software. D-Link makes no warranty that operation of its software products will be uninterrupted or absolutely error-free, and no warranty that all defects in the software product, within or without the scope of D-Link's applicable product documentation, will be corrected.

# D-Link® Offices

---

- Australia**      **D-Link Australia**  
1 Giffnock Avenue, North Ryde, NSW 2113,  
Sydney, Australia  
TEL: 61-2-8899-1800 FAX: 61-2-8899-1868  
TOLL FREE (Australia): 1800-177100  
URL: [www.dlink.com.au](http://www.dlink.com.au)  
E-MAIL: [support@dlink.com.au](mailto:support@dlink.com.au) & [info@dlink.com.au](mailto:info@dlink.com.au)
- Brazil**            **D-Link Brasil Ltda.**  
Edifício Manoel Tabacow Hydal,  
Rua Tavares Cabral 102 Sala 31, 05423-030  
Pinheiros, Sao Paulo, Brasil  
TEL: (55 11) 3094 2910 to 2920 FAX: (55 11) 3094 2921  
E-MAIL: [efreitas@dlink.cl](mailto:efreitas@dlink.cl)
- Canada**          **D-Link Canada**  
2180 Winston Park Drive, Oakville,  
Ontario, L6H 5W1 Canada  
TEL: 1-905-829-5033 FAX: 1-905-829-5095  
TOLL FREE: 1-800-354-6522 URL: [www.dlink.ca](http://www.dlink.ca)  
FTP: [ftp.dlinknet.com](ftp:dlinknet.com) E-MAIL: [techsup@dlink.ca](mailto:techsup@dlink.ca)
- Chile**            **D-Link South America (Sudamérica)**  
Isidora Goyenechea 2934 Of. 702, Las Condes Fono,  
2323185, Santiago, Chile, S. A.  
TEL: 56-2-232-3185 FAX: 56-2-232-0923  
URL: [www.dlink.cl](http://www.dlink.cl)  
E-MAIL: [ccasassu@dlink.cl](mailto:ccasassu@dlink.cl) & [tsilva@dlink.cl](mailto:tsilva@dlink.cl)
- China**            **D-Link China**  
15<sup>th</sup> Floor, Science & Technology Tower,  
No.11, Baishiqiao Road, Haidan District, 100081 Beijing, China  
TEL: 86-10-68467106 FAX: 86-10-68467110  
URL: [www.dlink.com.cn](http://www.dlink.com.cn)  
E-MAIL: [liweii@digitalchina.com.cn](mailto:liweii@digitalchina.com.cn)
- Denmark**        **D-Link Denmark**  
Naverland Denmark, Naverland 2, DK-2600 Glostrup, Copenhagen, Denmark  
TEL: 45-43-969040 FAX:45-43-424347  
URL: [www.dlink.dk](http://www.dlink.dk) E-MAIL: [info@dlink.dk](mailto:info@dlink.dk)
- Egypt**            **D-Link Middle East**  
7 Assem Ebn Sabet Street, Heliopolis, Cairo, Egypt  
TEL: 202-245-6176 FAX: 202-245-6192  
URL: [www.dlink-me.com](http://www.dlink-me.com)  
E-MAIL: [support@dlink-me.com](mailto:support@dlink-me.com) & [fateen@dlink-me.com](mailto:fateen@dlink-me.com)
- Finland**         **D-Link Finland**  
Pakkalankuja 7A, FIN-0150 Vantaa, Finland  
TEL: 358-9-2707-5080 FAX: 358-9-2707-5081  
URL: [www.dlink-fi.com](http://www.dlink-fi.com)
- France**          **D-Link France**  
Le Florilege, No. 2, Allée de la Fresnerie,  
78330 Fontenay-le-Fleury, France  
TEL: 33-1-3023-8688 FAX: 33-1-3023-8689  
URL: [www.dlink-france.fr](http://www.dlink-france.fr)  
E-MAIL: [info@dlink-france.fr](mailto:info@dlink-france.fr)
- Germany**        **D-Link Central Europe (D-Link Deutschland GmbH)**  
Schwalbacher Strasse 74, D-65760 Eschborn, Germany  
TEL: 49-6196-77990 FAX: 49-6196-7799300  
URL: [www.dlink.de](http://www.dlink.de)  
BBS: 49-(0) 6192-971199 (analog)  
BBS: 49-(0) 6192-971198 (ISDN)  
INFO: 00800-7250-0000 (toll free)  
HELP: 00800-7250-4000 (toll free)  
REPAIR: 00800-7250-8000 E-MAIL: [info@dlink.de](mailto:info@dlink.de)

- India**                   **D-Link India**  
Plot No.5, Bandra-Kurla Complex Rd., Off Cst Rd.,  
Santacruz (East), Mumbai, 400 098 India  
TEL: 91-022-652-6696/6578/6623  
FAX: 91-022-652-8914/8476  
URL: www.dlink-india.com & www.dlink.co.in  
E-MAIL: service@dlink.india.com & tushars@dlink-india.com
- Italy**                   **D-Link Mediterraneo Srl/D-Link Italia**  
Via Nino Bonnet n. 6/B, 20154, Milano, Italy  
TEL: 39-02-2900-0676 FAX: 39-02-2900-1723  
URL: www.dlink.it E-MAIL: info@dlink.it
- Japan**                   **D-Link Japan**  
10F, 8-8-15 Nishi-Gotanda, Shinagawa-ku, Tokyo 141, Japan  
TEL: 81-3-5434-9678 FAX: 81-3-5434-9868  
URL: www.d-link.co.jp E-MAIL: kida@d-link.co.jp
- Netherlands**       **D-Link Benelux**  
Fellenoord 130 5611 ZB, Eindhoven, The Netherlands  
TEL: 31-40-2668713 FAX: 31-40-2668666  
URL: www.d-link-benelux.nl & www.dlink-benelux.be  
E-MAIL: info@dlink-benelux.nl & info@dlink-benelux.be
- Norway**               **D-Link Norway**  
Waldemar Thranesgate 77, 0175 Oslo, Norway  
TEL: 47-22-99-18-90 FAX: 47-22-20-70-39 SUPPORT: 800-10-610  
URL: www.dlink.no
- Russia**               **D-Link Russia**  
Michurinski Prospekt 49, 117607 Moscow, Russia  
TEL: 7-095-737-3389 & 7-095-737-3492  
FAX: 7-095-737-3390 URL: www.dlink.ru  
E-MAIL: vl@dlink.ru
- Singapore**           **D-Link International**  
1 International Business Park, #03-12 The Synergy,  
Singapore 609917  
TEL: 6-6774-6233 FAX: 6-6774-6322  
E-MAIL: info@dlink.com.sg URL: www.dlink-intl.com
- South Africa**       **D-Link South Africa**  
Unit 2, Parkside, 86 Oak Avenue, Highveld Technopark,  
Centurion, Gauteng, South Africa  
TEL: 27-12-665-2165 FAX: 27-12-665-2186  
URL: www.d-link.co.za E-MAIL: attie@d-link.co.za
- Spain**                 **D-Link Iberia (Spain and Portugal)**  
Sabino de Arana, 56 bajos, 08028 Barcelona, Spain  
TEL: 34 93 409 0770 FAX: 34 93 491 0795  
URL: www.dlink.es E-MAIL: info@dlink.es
- Sweden**              **D-Link Sweden**  
P. O. Box 15036, S-167 15 Bromma, Sweden  
TEL: 46-8-564-61900 FAX: 46-8-564-61901  
URL: www.dlink.se E-MAIL: info@dlink.se
- Taiwan**               **D-Link Taiwan**  
2F, No. 119 Pao-chung Road, Hsin-tien, Taipei, Taiwan  
TEL: 886-2-2910-2626 FAX: 886-2-2910-1515  
URL: www.dlinktw.com.tw E-MAIL: dssqa@tsc.dlinktw.com.tw
- Turkey**               **D-Link Middle East**  
Deniz Bilgisayar, Buyukdere Cad. Naci Kasim Sk., No. 5  
Mecidiyekoy, Istanbul, Turkey  
TEL: 90-212-213-3400 FAX: 90-212-213-3420  
E-MAIL: smorovati@dlink-me.com
- U.A.E.**                **D-Link Middle East**  
CHS Aptec (Dubai), P.O. Box 33550 Dubai, United Arab Emirates  
TEL: 971-4-366-885 FAX: 971-4-355-941  
E-MAIL: Wxavier@dlink-me.com

**U.K.**

**D-Link Europe (United Kingdom) Ltd**

4<sup>th</sup> Floor, Merit House, Edgware Road, Colindale, London  
NW9 5AB United Kingdom  
TEL: 44-020-8731-5555 SALES: 44-020-8731-5550  
FAX: 44-020-8731-5511 SALES: 44-020-8731-5551  
BBS: 44 (0) 181-235-5511  
URL: [www.dlink.co.uk](http://www.dlink.co.uk) E-MAIL: [info@dlink.co.uk](mailto:info@dlink.co.uk)

**U.S.A.**

**D-Link U.S.A.**

17395 Mt. Herrmann, Fountain Valley, CA 92708-4160  
TEL: 1-949-788-0805 FAX: 1-949-753-7033  
INFO: 1-800-326-1688 URL: [www.dlink.com](http://www.dlink.com)  
E-MAIL: [tech@dlink.com](mailto:tech@dlink.com) & [support@dlink.com.tw](mailto:support@dlink.com.tw)

# MEMO

---

---

---

---

---

---

---

---

---

---

---

---

---

---

---

---

---

---

---

---

---

---

---

---

---

---

---

---

## Registration Card ( Excluding USA)

*Print, type or use block letters.*

Your name: Mr./Ms \_\_\_\_\_  
 Organization: \_\_\_\_\_ Dept. \_\_\_\_\_  
 Your title at organization: \_\_\_\_\_ Telephone: \_\_\_\_\_ Fax: \_\_\_\_\_  
 Organization's full address: \_\_\_\_\_  
 Country: \_\_\_\_\_  
 Date of purchase (Month/Day/Year): \_\_\_\_\_

Product Model	Product Serial No.	* Product installed in type of computer (e.g., Compaq 486)	* Product installed in computer serial No.

(\* Applies to adapters only)

*Product was purchased from:*

Reseller's name: \_\_\_\_\_  
 Telephone: \_\_\_\_\_ Fax: \_\_\_\_\_  
 Reseller's full address: \_\_\_\_\_

**Answers to the following questions help us to support your product:**

1. **Where and how will the product primarily be used?**  
Home Office Travel Company Business Home Business Personal Use
2. **How many employees work at installation site?**  
1 employee 2-9 10-49 50-99 100-499 500-999 1000 or more
3. **What network protocol(s) does your organization use ?**  
XNS/IPX TCP/IP DECnet Others \_\_\_\_\_
4. **What network operating system(s) does your organization use ?**  
D-Link LANsmart Novell NetWare NetWare Lite SCO Unix/Xenix PC NFS 3Com 3+Open  
Banyan Vines DECnet Pathwork Windows NT Windows 2000 Windows XP  
Others \_\_\_\_\_
5. **What network management program does your organization use ?**  
D-View HP OpenView/Windows HP OpenView/Unix SunNet Manager Novell NMS  
NetView 6000 Others \_\_\_\_\_
6. **What network medium/media does your organization use ?**  
Fiber-optics Thick coax Ethernet Thin coax Ethernet 10BASE-T UTP/STP  
100BASE-TX 100BASE-T4 100VGAnyLAN Others \_\_\_\_\_
7. **What applications are used on your network?**  
Desktop publishing Spreadsheet Word processing CAD/CAM Database management Accounting  
Others \_\_\_\_\_
8. **What category best describes your company?**  
Aerospace Engineering Education Finance Hospital Legal Insurance/Real Estate Manufacturing  
Retail/Chainstore/Wholesale Government Transportation/Utilities/Communication VAR System house/company Other \_\_\_\_\_
9. **Would you recommend your D-Link product to a friend?**  
Yes No Don't know yet
10. **Your comments on this product?** \_\_\_\_\_  
 \_\_\_\_\_  
 \_\_\_\_\_  
 \_\_\_\_\_

PLEASE  
PLACE STAMP  
HERE

**TO:** \_\_\_\_\_  
\_\_\_\_\_  
\_\_\_\_\_

**D-Link®**