



**User Manual**

## **AC1200 Wi-Fi Gigabit Router**

---

# Preface

D-Link reserves the right to revise this publication and to make changes in the content hereof without obligation to notify any person or organization of such revisions or changes.

## Manual Revisions

Hardware	Revision	Date	Description
A1	v1.00	2020/07/21	Initial release

## Trademarks

D-Link and the D-Link logo are trademarks or registered trademarks of D-Link Corporation or its subsidiaries in the United States or other countries. All other company or product names mentioned herein are trademarks or registered trademarks of their respective companies.

Apple®, Apple logo®, Safari®, iPhone®, and Macintosh® are trademarks of Apple Inc., registered in the U.S. and other countries. App Store<sup>SM</sup> is a service mark of Apple Inc.

Chrome™ browser, Google Play™ and Android™ are trademarks of Google Inc.

Internet Explorer®, Windows® and the Windows logo are trademarks of the Microsoft group of companies.

Copyright © 2020 by D-Link Corporation, Inc.

All rights reserved. This publication may not be reproduced, in whole or in part, without prior expressed written permission from D-Link Corporation, Inc.

---

## ErP Power Usage

This device is an Energy Related Product (ErP) with High Network Availability (HiNA), and automatically switches to a power-saving Network Standby mode within 1 minute of no packets being transmitted. It can also be turned off through a power switch to save energy when it is not needed.

<b>DIR-1260</b>	Network Standby: 5.58 watts Switched Off: 0.08 watts
-----------------	---

# Table of Contents

<b>Product Overview.....</b>	<b>1</b>	IPv4 - L2TP .....	36
Package Contents.....	1	IPv4 - DS-Lite .....	38
System Requirements.....	2	Internet - IPv6.....	39
Features.....	3	IPv6 - Auto Detection .....	40
Hardware Overview .....	4	IPv6 - Static IPv6 .....	42
LED Indicators .....	4	IPv6 - Auto Configuration (SLAAC/DHCPv6).....	44
Back Panel .....	5	IPv6 - PPPoE .....	47
<b>Installation .....</b>	<b>6</b>	IPv6 - 6rd .....	51
Before you Begin.....	6	IPv6 - Local Connectivity Only .....	53
Wireless Installation Considerations.....	7	Internet - VLAN .....	54
Setup.....	8	Wireless(Wi-Fi) .....	56
D-Link Wi-Fi App Setup.....	9	Guest Zone.....	60
Hardware Setup .....	11	Network(LAN) .....	62
Setup Wizard .....	14	Features.....	64
<b>Configuration.....</b>	<b>21</b>	Parental Control .....	64
Home .....	22	QoS Engine.....	66
Internet.....	24	Firewall Settings - Advanced .....	68
DIR-2160.....	25	Firewall Settings - IPv4/IPv6 Rules.....	70
Connected Clients .....	26	Port Forwarding .....	72
Settings .....	28	Port Forwarding - Virtual Server .....	74
Wizard .....	28	Website Filter.....	76
Internet(WAN) - IPv4.....	29	Static Route - IPv4.....	77
IPv4 - Dynamic IP (DHCP).....	30	Static Route - IPv6.....	78
IPv4 - Static IP .....	31	Dynamic DNS .....	79
IPv4 - PPPoE .....	32	Quick VPN .....	81
IPv4 - PPTP.....	34	Management.....	82
		Time & Schedule - Time .....	82

Time & Schedule - Schedule .....	83	VPN Setup Instructions.....	122
System Log.....	84	Connect or Disconnect.....	124
System Admin - Admin.....	86	Android .....	125
System Admin - System.....	87	VPN Setup Instructions.....	125
User.....	88	Connect or Disconnect.....	127
Upgrade .....	89	<b>Connect a Wireless Client to your Router .....</b>	<b>129</b>
Statistics .....	90	WPS Button.....	129
<b>Third Party Services.....</b>	<b>91</b>	Windows® 10 .....	130
Registering a D-Link Cloud Service Account .....	92	Windows® 8 - WPA/WPA2.....	131
Amazon Alexa Setup .....	95	Windows® 7.....	133
Amazon Alexa Voice Commands .....	99	<b>Troubleshooting .....</b>	<b>135</b>
The Google Assistant Setup.....	100	<b>Wireless Basics .....</b>	<b>137</b>
The Google Assistant Voice Commands.....	103	<b>Wireless Modes .....</b>	<b>141</b>
<b>Quick VPN.....</b>	<b>104</b>	<b>Networking Basics .....</b>	<b>142</b>
Important Information .....	105	<b>Wireless Security .....</b>	<b>144</b>
iOS Devices .....	106	<b>Technical Specifications .....</b>	<b>145</b>
VPN Setup Instructions.....	106	<b>Federal Communication Commission Interference</b>	
Connect or Disconnect.....	108	<b>Statement.....</b>	<b>146</b>
Mac OS X.....	109		
VPN Setup Instructions.....	109		
Connect or Disconnect.....	111		
Windows 7.....	112		
VPN Setup Instructions.....	112		
Connect or Disconnect.....	115		
Windows 8.1/8.....	116		
VPN Setup Instructions.....	116		
Connect or Disconnect.....	121		
Windows 10 .....	122		

# Product Overview

## Package Contents

	DIR-1260
DIR-1260	V
Quick Installation Guide	V
Quick Installation Card	V
Ethernet Cable (RJ45)	V
Power Adapter	V

*If any of the above items are missing or damaged, please contact your local reseller.*

**Note:** *Using a power supply with a different voltage rating than the one included with the router will cause damage and void the warranty for this product.*

# System Requirements

<b>Network Requirements</b>	<ul style="list-style-type: none"><li>• An Ethernet-based cable, DSL or fiber modem</li><li>• IEEE 802.11ac/n/g/b/a wireless clients</li><li>• 10/100/1000 Ethernet</li></ul>
<b>Web-based Configuration Utility Requirements</b>	<p><b>Computer with the following:</b></p> <ul style="list-style-type: none"><li>• Windows®, Macintosh, or Linux-based operating system</li><li>• An installed Ethernet adapter</li></ul> <p><b>Browser Requirements:</b></p> <ul style="list-style-type: none"><li>• Internet Explorer 10 or higher</li><li>• Firefox 28 or higher</li><li>• Safari 6 or higher</li><li>• Chrome 28 or higher</li></ul> <p><b>Windows® Users:</b> Make sure you have the latest version of Java installed. Visit <a href="http://www.java.com">www.java.com</a> to download the latest version.</p>
<b>D-Link Wi-Fi App Requirements</b>	<ul style="list-style-type: none"><li>• iOS® or Android™ device (Please refer to the app's store page to check whether your device is compatible.)</li></ul>

# Features

Need super-fast Wi-Fi for your wire-free, all-streaming house? With a powerful dual-core processor, the AC1200 Wi-Fi Gigabit Router packs in enough processing power to handle every networking task you throw at it. It's a powerful, intelligent home router with integrated voice assistant compatibility for Amazon Alexa and Google Assistant so you can control your network with voice commands.

## **Handle More with a High-Power Processor**

With the DIR-1260, you're not only enjoying buffer-free gaming and lightning fast surfing, you're also enjoying features such as an optimizing QoS, an automatic firmware update system that ensures the best protection and the latest features, and compatibility with voice assistants. All this is possible with the router's 880 MHz dual-core high-power processor, 128 MB of flash memory and 128 MB of RAM.

## **Enhanced Quality of Service Features**

The built-in Quality of Service (QoS) engine allows you to prioritize important traffic to ensure that your favorite applications are receiving optimal bandwidth.

## **Always Up-to-Date with the Latest Features**

The DIR-1260 will automatically check daily for updates to make sure that the device always has the latest features and the most secure firmware, and will install the update silently in the background. For an extra peace of mind, in the event of failure during the firmware update, the router will store a backup system image in the memory before proceeding with the update.

## **Easy to Set Up and Manage**

Sharing your Internet connection doesn't have to be a complicated process; just download the free D-Link Wi-Fi app for your mobile device and follow the on-screen step-by-step instructions to set up your DIR-1260. You also have the option to use a web browser to access the setup wizard and to manage your router. Support for industry-standard Wi-Fi Protected Setup (WPS) lets you create encrypted connections to new devices by pressing a button.



# Hardware Overview

## LED Indicators



1	<b>Power</b>	Solid White	The device is on and the system is healthy.
		Solid Orange	The device is booting up or performing the factory reset process.
		Blinking Orange	The device is under recovery mode.
2	<b>Internet</b>	Solid White	The Internet port connection is established.
		Solid Orange	The device cannot connect to the Internet.
		Blinking Orange	The device is undergoing the firmware upgrade process.
3	<b>Wireless (2.4 GHz)</b>	Solid White	The 2.4 GHz wireless band is enabled.
		Blinking White	The device is processing WPS.
4	<b>Wireless (5 GHz)</b>	Solid White	The 5 GHz wireless band is enabled.
		Blinking White	The device is processing WPS.

## Back Panel

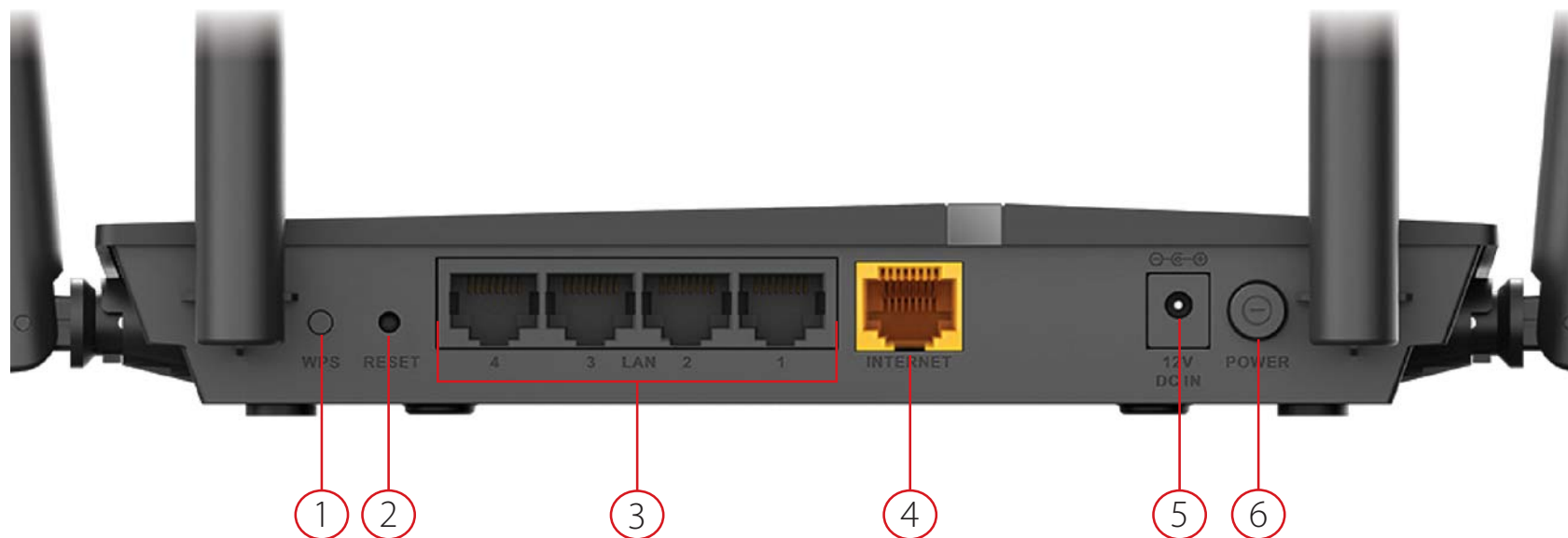

1	<b>WPS Button</b>	Press to start the WPS process and automatically create an encrypted connection to a WPS client.
2	<b>Reset Button</b>	Insert a paperclip in the hole, wait for 10 seconds, and release to reset the router to default settings.
3	<b>Gigabit LAN Ports (1-4)</b>	Connect Ethernet devices such as computers, switches, storage (NAS) devices, and game consoles.
4	<b>Gigabit WAN Port</b>	Using an Ethernet cable, connect your broadband modem to this port.
5	<b>Power Connector</b>	Connector for the supplied power adapter.
6	<b>Power Button</b>	Press the power button to power the device on or off.

# Installation

This section will walk you through the installation of your DIR-1260.

## Before you Begin

- Placement of the router is very important. Do not place the router in an enclosed area such as a closet, cabinet, attic, or garage.
- Configure the router with the computer that was last connected directly to your Internet connection. Verify that it is connected to the Internet before connecting additional devices.
- You can only use the Ethernet port on your modem. If you were using the USB connection before using the router, then you must turn off your modem, disconnect the USB cable and connect an Ethernet cable to the Internet port on the router, and then turn the modem back on. In some cases, you may need to call your Internet Service Provider (ISP) to change connection types (USB to Ethernet).
- If connecting to a DSL modem, make sure to have your DSL service information provided by your Internet Service Provider handy. This information is likely to include your DSL account's Username and Password. Your ISP may also supply you with additional WAN configuration settings which might be necessary to establish a connection.
- If you are connecting a considerable amount of networking equipment, it may be a good idea to take the time to label each cable or take a picture of your existing setup before making any changes.
- If you have DSL and are connecting via PPPoE, make sure you disable or uninstall any PPPoE software such as WinPoET, BroadJump, or EnterNet 300 from your computer or you will not be able to connect to the Internet.

## Wireless Installation Considerations

The D-Link wireless router lets you access your network using a wireless connection from virtually anywhere within the operating range of your wireless network. Keep in mind that the number, thickness and location of walls, ceilings, or other objects that the wireless signals must pass through may limit the range. Typical ranges vary depending on the types of materials and background RF (radio frequency) noise in your home or business. The key to maximizing wireless range is to follow these basic guidelines:

1. Keep the number of walls and ceilings between the D-Link router and other network devices to a minimum - each wall or ceiling can reduce your adapter's range from 3-90 feet (1-30 meters.) Position your devices so that the number of walls or ceilings is minimized.
2. Be aware of the direct line between network devices. A wall that is 1.5 feet thick (0.5 meters), at a 45-degree angle appears to be almost 3 feet (1 meter) thick. At a 2-degree angle it looks over 42 feet (14 meters) thick. Position devices so that the signal will travel straight through a wall or ceiling (instead of at an angle) for better reception.
3. Building materials make a difference. A solid metal door or aluminum studs may have a negative effect on range. Try to position access points, wireless routers, and computers so that the signal passes through drywall or open doorways. Materials and objects such as glass, steel, metal, walls with insulation, water (fish tanks), mirrors, file cabinets, brick, and concrete will degrade your wireless signal.
4. Keep your product away (at least 3-6 feet or 1-2 meters) from electrical devices or appliances that generate RF noise.
5. If you are using 2.4 GHz cordless phones or X-10 (wireless products such as ceiling fans, lights, and home security systems), your wireless connection may degrade dramatically or drop completely. Make sure your 2.4 GHz phone base is as far away from your wireless devices as possible. The base transmits a signal even if the phone is not in use.

# Setup

There are several different ways you can configure your router to connect to the Internet

- **D-Link Wi-Fi App** - Use your compatible Android or iOS device to install and configure your router. Refer to **D-Link Wi-Fi App Setup** on page **9**.
- **Hardware Setup** - This section explains how to setup your DIR-1260. Refer to **Hardware Setup** on page **11**.
- **D-Link Setup Wizard** - This wizard will launch when you log into the router by using your PC for the first time. Refer to **Setup Wizard** on page **14**.
- **Manual Setup** - Log in to the router to manually configure your router. Refer to **Configuration** on page **21**

# D-Link Wi-Fi App Setup

The D-Link Wi-Fi app allows you to install and configure your DIR-1260 from your compatible Android or iOS device.

**Note:** *The screenshots may be different depending on your mobile device's OS version. The following steps show the iOS interface of the D-Link Wi-Fi app. If you are using an Android device, the appearance may be different from that of the screenshots, but the process is the same.*

## Step 1

Search and install the free **D-Link Wi-Fi** app available on the App Store or on Google Play. You can also scan the QR code on the right, which will take you to the respective D-Link Wi-Fi app store page.



## Step 2

Launch the D-Link Wi-Fi app from the home screen of your device.



D-Link Wi-Fi

## Step 3

Tap on the **Install New Device** button at the middle of the screen.

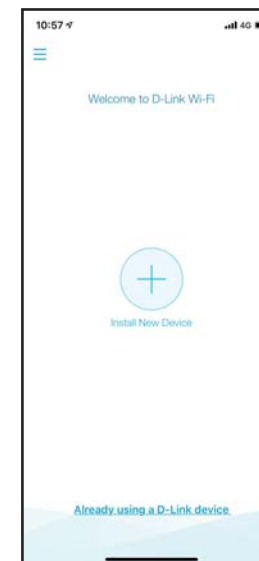

### Step 4

Tap **Scan the QR code** to scan the setup QR code located in the Quick Installation Card and proceed to step 6. Alternatively, you can tap **Continue without scanning** to proceed to step 5.

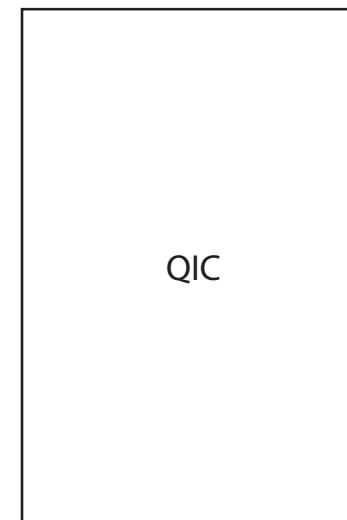

### Step 5

Select **Router** and select **DIR-1260** from the list of available devices. Tap **Next** to continue.



### Step 6

You will now be guided through a step-by-step process for setting up your router. Simply follow the on-screen instructions to continue the installation and the configuration process.

# Hardware Setup

## Step 1

Position your DIR-1260 near your Internet-connected modem. Place it in an open area for better wireless coverage.

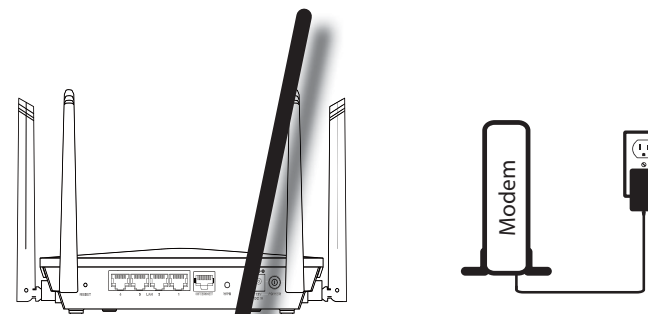

## Step 2

Turn off and unplug the power to your cable or DSL broadband modem. This is required. In some cases, you may need to turn it off for up to five minutes.

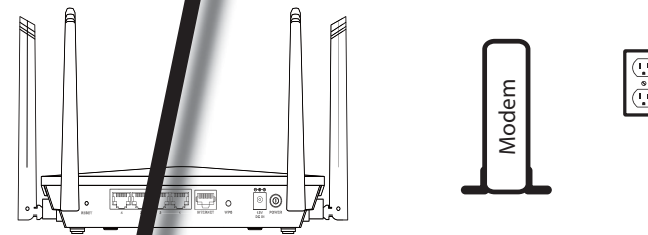

## Step 3

Use the Ethernet cable to connect your modem to the port labelled **INTERNET** on the router.

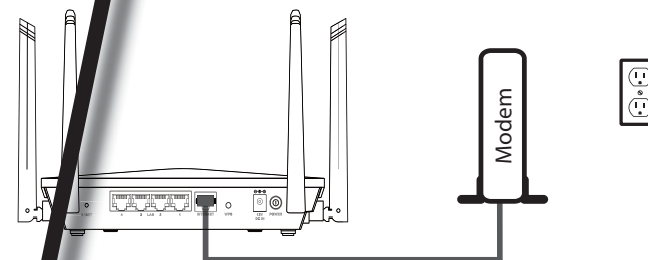



**Step 4**

Plug in and turn your modem back on and wait approximately one minute before proceeding.

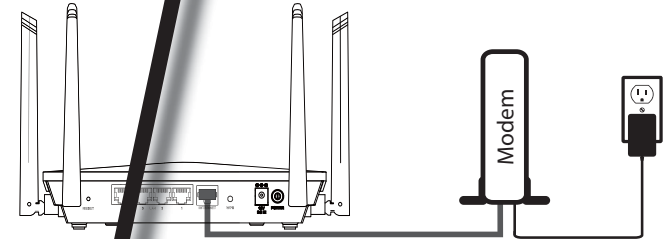

**Step 5**

Connect the supplied power adapter to the router and a power outlet, press the power button, and wait approximately one minute until the LED indicator on the front of the device changes from orange to solid white.

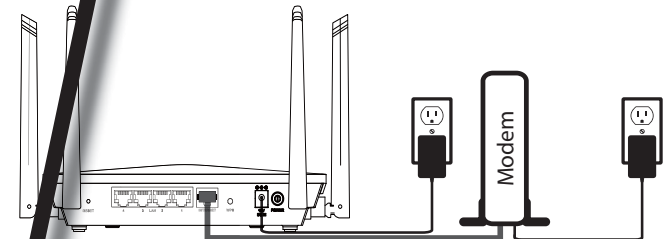

**Step 6**

If you are configuring the router wirelessly from a PC, connect to the Wi-Fi network printed on the label attached to the bottom of your router or in the Quick Installation Card.

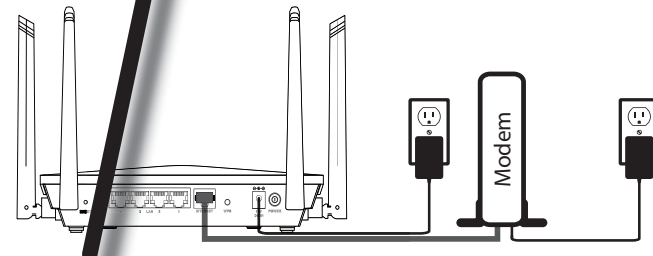

If you are configuring the router from a PC with a wired Ethernet connection, plug one end of an Ethernet cable into the port labeled 1 on the back of the router, and the other end into the Ethernet port on your computer.

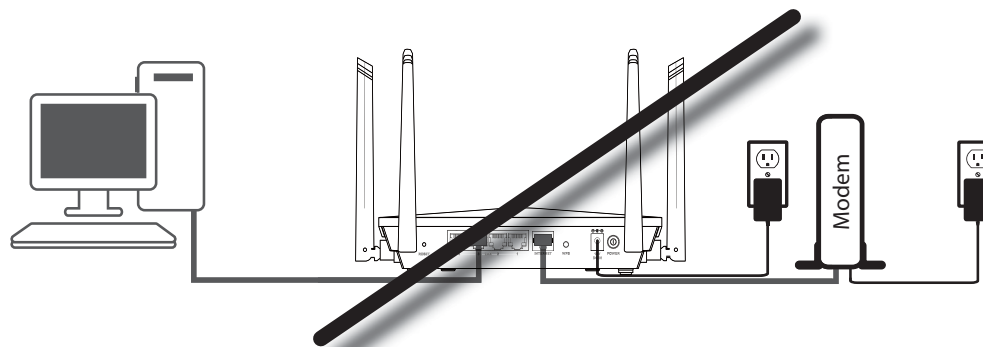

### Step 7

If you are connecting to a broadband service that uses a dynamic connection (not PPPoE), you may be online already. Try opening a web browser and connecting to a website. If the website does not load, proceed to **Setup Wizard** on page **14**.

## Setup Wizard

The setup wizard is designed to guide you through a step-by-step process to configure your new DIR-1260 and connect to the Internet via a wireless setup process.

If this is your first time installing the router, open your web browser and enter **http://dlinkrouter.local/** in the address bar. Alternatively, enter the IP address of the router (default: **http://192.168.0.1**).

If this is your first time logging in to the page and no connection has been established, then log in with the password shown on the device label or Quick Install Guide.

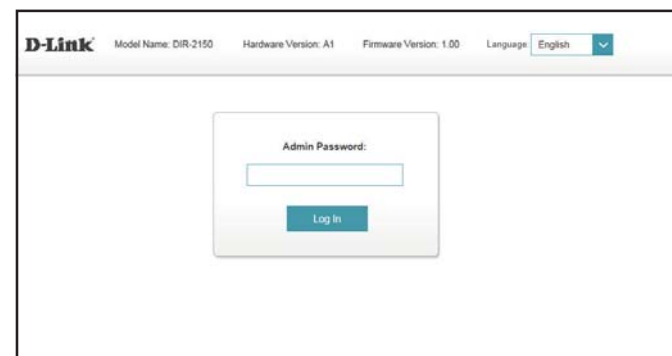

Agree to the Terms of Use and Privacy Policy before proceeding.

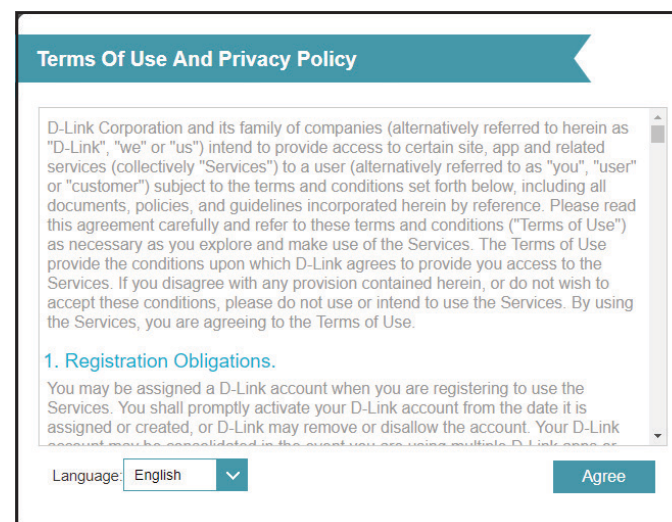

Follow the on-screen instructions to configure your new D-Link router and connect to the Internet.

Click **Next** to continue.

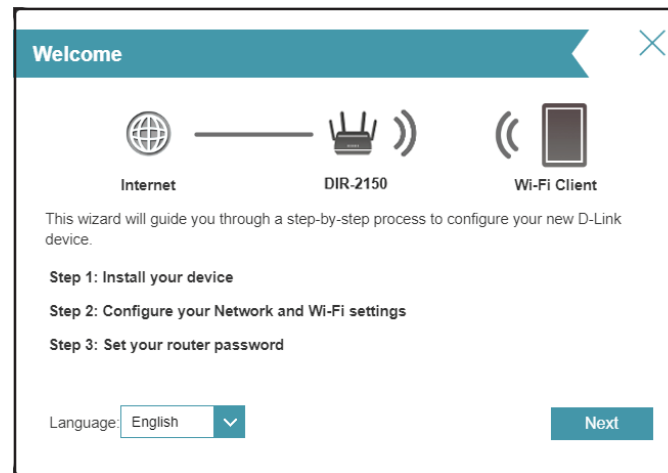

Please wait while your router detects your Internet connection type.

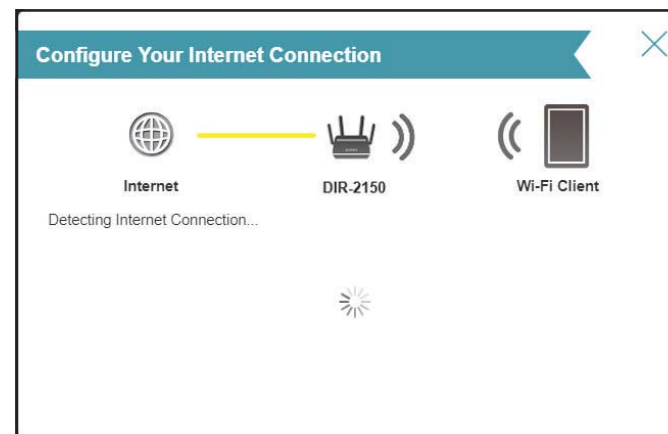

If the router does not detect a valid Internet connection, a list of connection types to choose from will be displayed. Select your Internet connection type (this information can be obtained from your Internet Service Provider).

Click **Next** to continue.

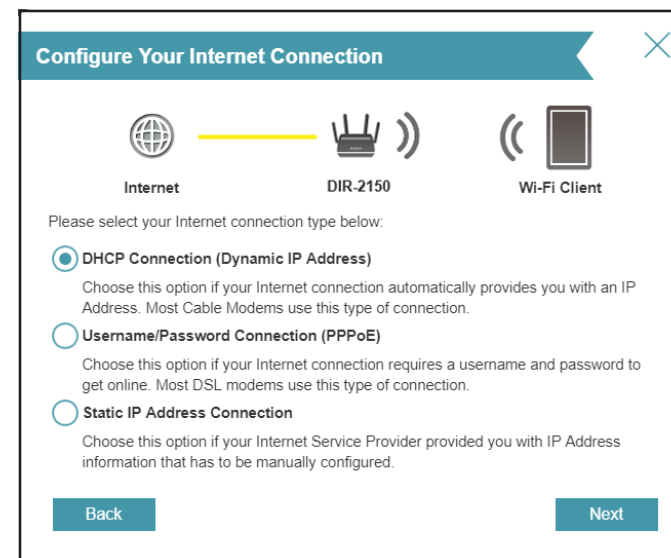

If the router detected or you selected **PPPoE**, enter your PPPoE username and password. If you do not have this information, please contact your ISP.

Click **Next** to continue.

**Note:** Make sure to remove all other existing PPPoE software from your computer. The software is no longer needed and will not work through a router.

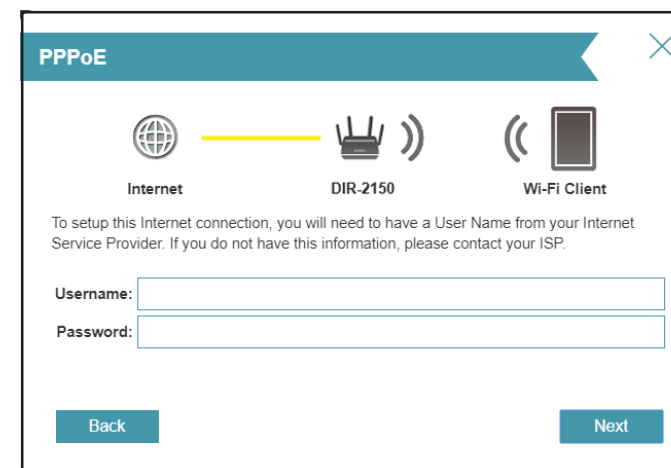

If the router detected or you selected **Static**, enter the IP and DNS settings supplied by your ISP. If you do not have this information, please contact your ISP.

Click **Next** to continue.

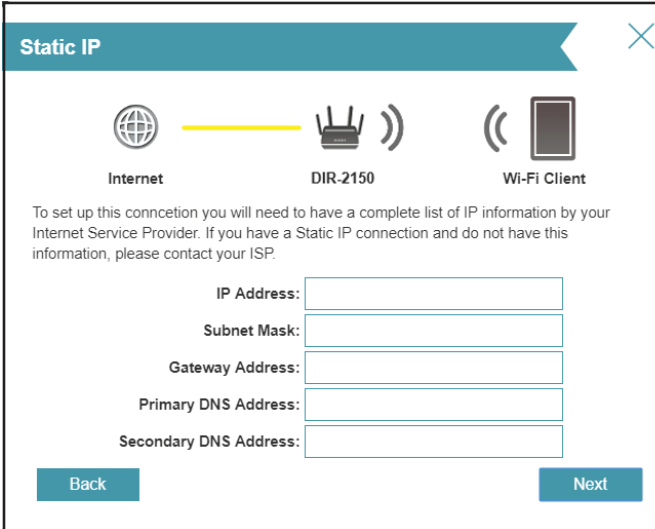

The screenshot shows the 'Static IP' configuration screen. At the top, there is a teal header with the text 'Static IP' and a close button (X). Below the header, there is a network diagram showing 'Internet' connected to 'DIR-2150' (the router), which is then connected to a 'Wi-Fi Client'. The text below the diagram reads: 'To set up this connection you will need to have a complete list of IP information by your Internet Service Provider. If you have a Static IP connection and do not have this information, please contact your ISP.' There are five input fields: 'IP Address:', 'Subnet Mask:', 'Gateway Address:', 'Primary DNS Address:', and 'Secondary DNS Address:'. At the bottom, there are 'Back' and 'Next' buttons.

Type in a **Wi-Fi Network Name** and **Wi-Fi Password** to setup your Wi-Fi network. Your wireless clients will need to have this passphrase to be able to connect to your wireless network.

Click **Next** to continue.

**Note:** *The router's Smart Connect feature presents a single wireless network. When connecting clients to an extension network, they will be automatically added to the best band, either 2.4 GHz or 5 GHz. To disable the Smart Connect feature and individually configure 2.4 GHz and 5 GHz networks, refer to **Wireless** on page 56.*

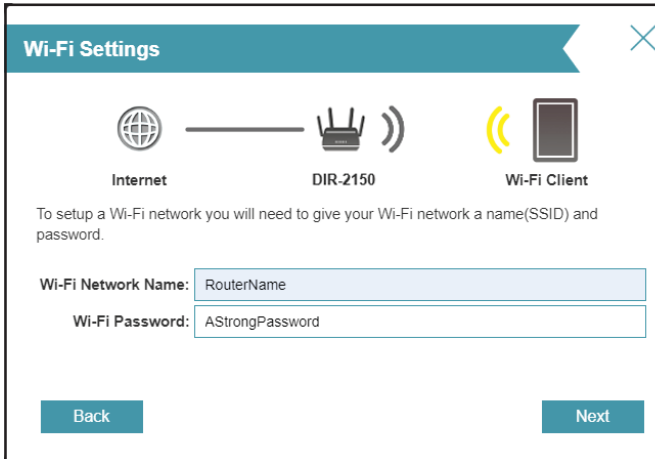

The screenshot shows the 'Wi-Fi Settings' configuration screen. At the top, there is a teal header with the text 'Wi-Fi Settings' and a close button (X). Below the header, there is a network diagram showing 'Internet' connected to 'DIR-2150' (the router), which is then connected to a 'Wi-Fi Client'. The text below the diagram reads: 'To setup a Wi-Fi network you will need to give your Wi-Fi network a name(SSID) and password.' There are two input fields: 'Wi-Fi Network Name:' with the value 'RouterName' and 'Wi-Fi Password:' with the value 'AStrongPassword'. At the bottom, there are 'Back' and 'Next' buttons.

In order to secure the router's configuration access, please enter a password. You will be prompted for this password every time you want to use the router's web configuration utility.

Click **Next** to continue.

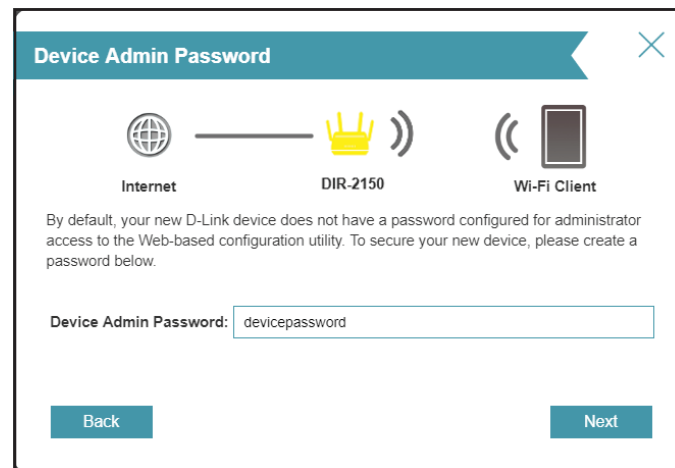

Select your time zone from the drop-down menu.

Click **Next** to continue.

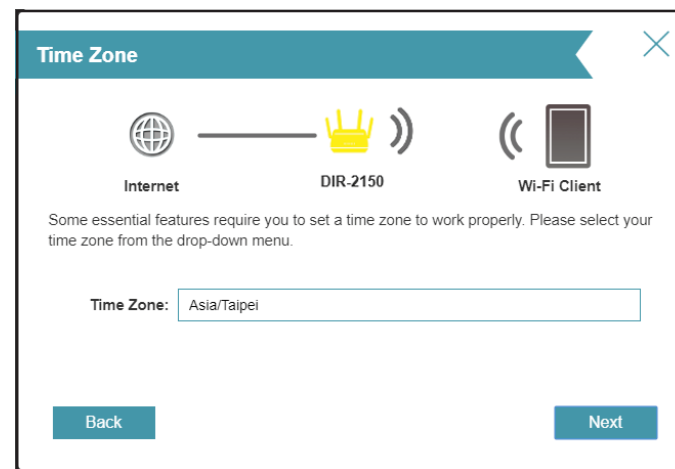

Keeping your router's firmware up-to-date provides you with the latest protection and new features over the air. Choose whether to keep your device up-to-date automatically or to manage the device updates by yourself.

Click **Next** to continue.

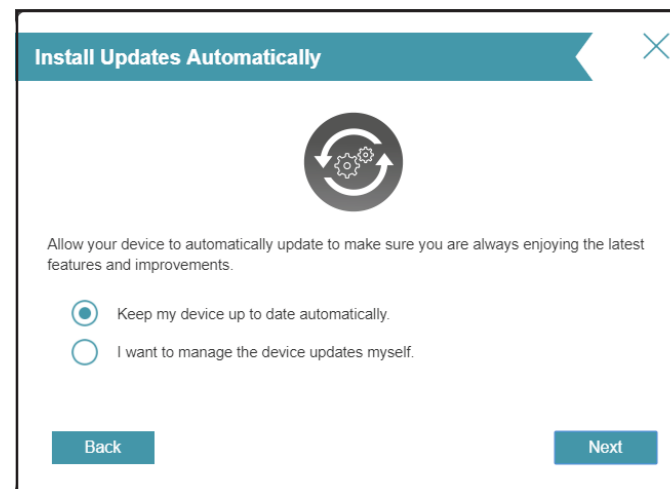

You will be presented with a summary of your settings.

Click **Next** to finalize the settings or **Back** to make changes.

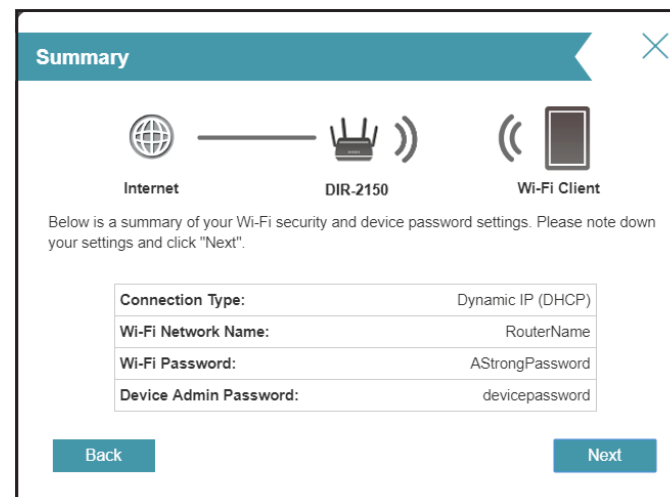



Please wait while the device settings are saved.

Do not turn off or unplug your router during this time.



Your new settings have been saved and your router is now configured.

Click **OK** to close the Setup Wizard.

Congratulations, your device has been successfully configured!

You can log in to the configuration utility by inputting the Admin Password.

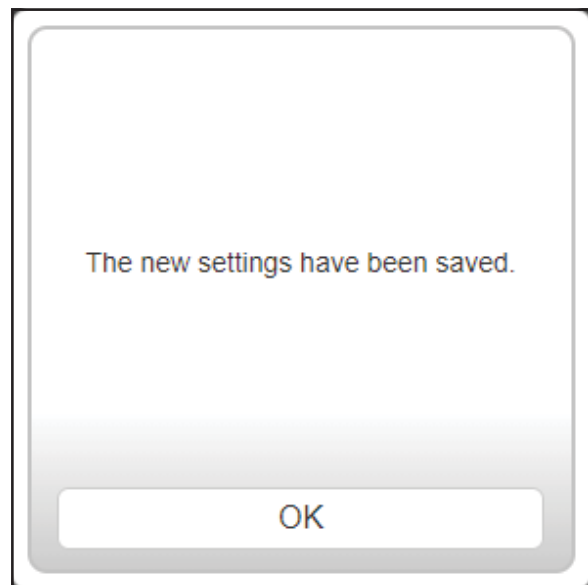

# Configuration

To access the configuration utility, open your web-browser and enter **http://dlinkrouter.local./** or you may also connect by typing the IP address of the router (by default this is **http://192.168.0.1**) in the address bar.

Enter your password. If you previously followed the setup wizard, please use the admin password you entered during the wizard. Otherwise, log in with the password shown on the device label or Quick Install Guide.. Click **Log In** to proceed.

**Note:** *If you cannot remember your password and cannot log in, use a paperclip to press the recessed **Reset** button on the back of the device for longer than 10 seconds to restore the router to its default settings.*

The router's home page will open displaying its current connection status.

The bar at the top of the page has quick access to **Settings**, **Features** and **Management** functions. You can quickly jump back Home at any time.

**Note:** *The system will automatically log out after a period of inactivity.*

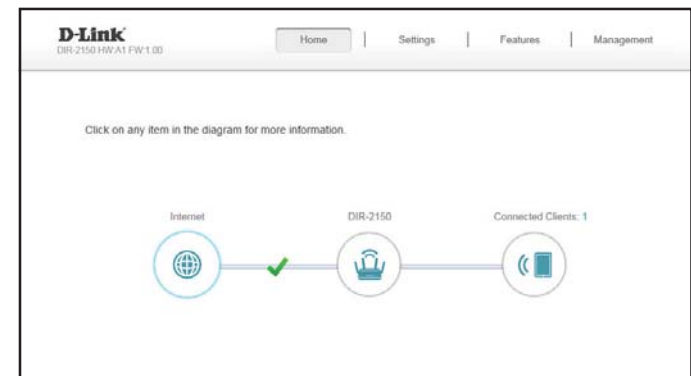
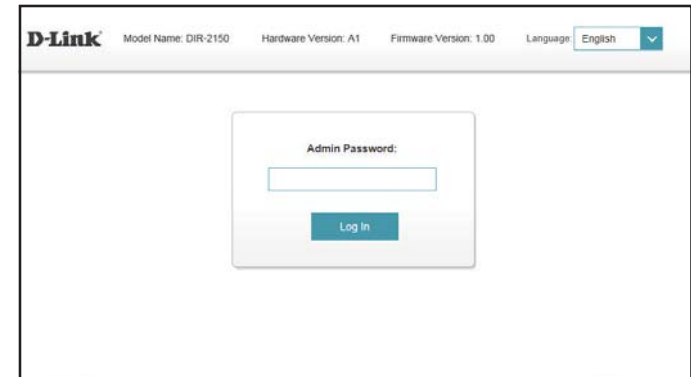

# Home

The Home page displays the current status of the router in the form of an interactive diagram. You can click each icon to display information about each part of the network at the bottom of the screen. The menu bar at the top of the page will allow you to quickly navigate to other pages.

The Home page displays whether or not the router is currently connected to the Internet.

Click **Pause Internet Access** to pause Internet access

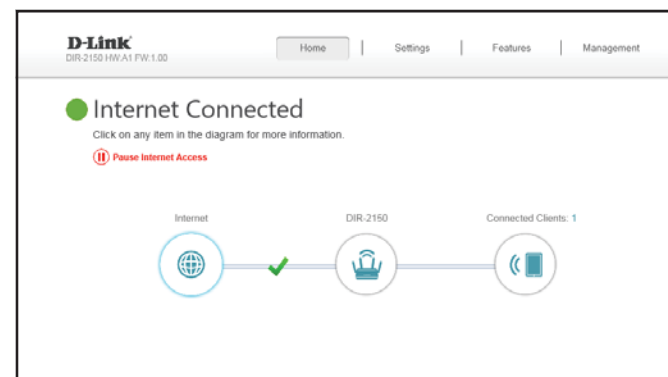

If it is disconnected, click **Click to repair** to bring up the setup wizard, refer to the **Setup Wizard** on page 14 for more information.

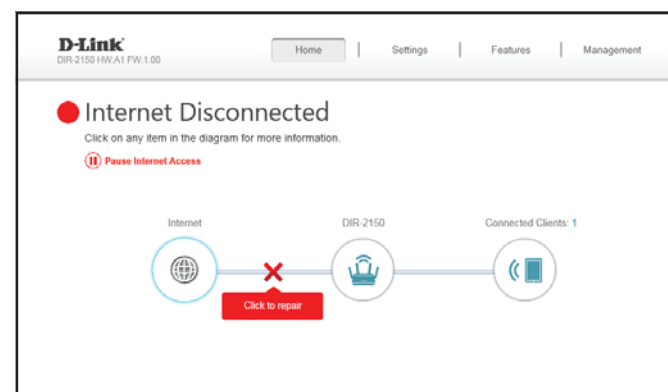

If it is paused, click **Resume Internet Access** to resume Internet access.

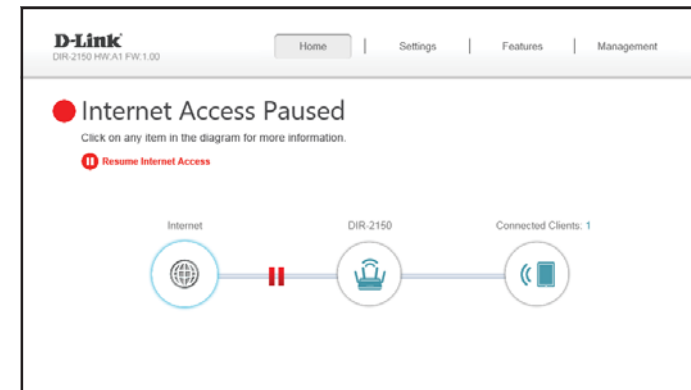

# Internet

To bring up more details about your Internet connection, click on the **Internet** icon.

Click **IPv4** or **IPv6** to see details of the IPv4 connection and IPv6 connection respectively.

Click **Release IP Address** to disconnect from the Internet. If you do this and wish to reconnect, click **Renew**.

To reconfigure the Internet settings, refer to **Internet - IPv4** on page **29**



The screenshot displays the D-Link DIR-2150 web interface. At the top, the navigation menu includes Home, Settings, Features, and Management. The main heading is "Internet Connected" with a green status indicator. Below this, there is a "Pause Internet Access" button. A network diagram shows the connection path: Internet (globe icon) connected to DIR-2150 (router icon) with a green checkmark, which is then connected to Connected Clients (1 client icon). Below the diagram, the "Internet" section provides detailed connection information:

Internet		IPv4 / IPv6	
Cable Status:	Connected	MAC Address:	C4:E9:0A:A9:9A:92
Connection Type:	Dynamic IP (DHCP)	IP Address:	172.17.6.43
Network Status:	Connected	Subnet Mask:	255.255.255.0
Connection Uptime:	0 Day 0 Hour 0 Min 44 Sec	Default Gateway:	172.17.6.254
		Primary DNS Server:	192.168.168.249
		Secondary DNS Server:	192.168.168.250

A "Release IP Address" button is visible at the bottom of the Internet section.

## DIR-1260

Click on the **DIR-1260** icon to view details about the router and its wireless settings.

Here you can see the router's current Wi-Fi network name and password, as well as the router's MAC address, IPv4 address, and IPv6 address.

To reconfigure the network settings, either click **Go to settings** on the lower left, or click **Settings** (at the top of the page) and then **Network** on the menu that appears. Refer to **Network** on page **62** for more information.

To reconfigure the wireless settings, either click **Go to settings**, on the lower right, or click **Settings** (at the top of the page) and then **Wireless** on the menu that appears. Refer to **Wireless** on page **56** for more information.

The screenshot displays the D-Link DIR-2150 web interface. At the top, there is a navigation bar with 'Home', 'Settings', 'Features', and 'Management' tabs. Below the navigation bar, a green circle indicates 'Internet Connected'. A diagram shows the network flow: Internet (globe icon) connected to DIR-2150 (router icon) with a green checkmark, which is then connected to Connected Clients (1) (phone icon). Below the diagram, the 'DIR-2150' section provides network details:

IPv4 Network		Wi-Fi	
MAC Address:	C4:E9:DA:6F:A0:0E	Status:	Enabled
Router IP Address:	192.168.0.1	Wi-Fi Name (SSID):	dlink-A00E
Subnet Mask:	255.255.255.0	Password:	fyvt46968

Below the IPv4 Network section, there is an 'IPv6 Network' section with the following details:

Link-Local Address:	
Router IPv6 Address:	Not Available
DHCP-PD:	Disabled

There are 'Go to settings' links with arrows at the bottom right of both the IPv4 and IPv6 sections.

## Connected Clients

Click on the **Connected Clients** icon to view details about the connected clients to the router and their wireless settings.

On this page you can see all the clients currently connected to the router, and their IP addresses.

To edit each client's settings, click the pencil icon on the client you want to edit.

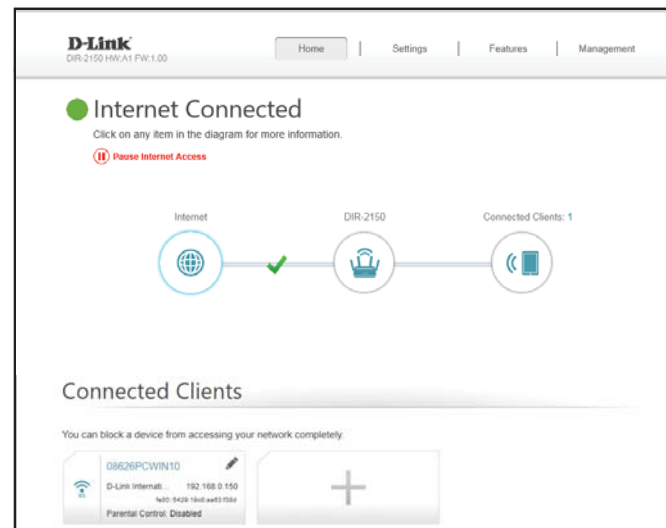

### Edit Rule

- Name** Enter a custom name for this client.
- Vendor** Displays the vendor of the client.
- MAC Address** Displays the MAC address of the client.
- IP Address** Displays the current IP address of the client.
- Reserve IP** Enable to reserve an IP address for the client.
- IP Address (Reserved)** Specify an IP address for the router's DHCP server to assign.
- Parental Control** Enable Parental Control for the client to specify whether it is allowed network access.
- Schedule** Use the drop-down menu to select the time schedule that the Parental Controls will be enabled for. The schedule may be set to Always OFF meaning that the client will always be blocked from accessing the network, or you can create your own schedules in the Schedules section to specify the times that the client is allowed to access the network. Refer to **Time & Schedule - Schedule** on page **83** for more information.

Click **Save** when you are done.

Edit Rule
✕

Name:

Vendor: D-Link International

MAC Address: c8:d3:a3:03:43:86

IP Address: 192.168.0.106

Reserve IP:  Enabled Remaining: 24

IP Address (Reserved):

Parental Control:  Enabled

Schedule:  ▼



# Settings Wizard

In the Settings menu on the bar at the top of the page, click **Wizard** to open the setup wizard. This is the same wizard that appears when you start the router for the first time. Refer to **Setup Wizard** on page **14** for details.

**Note:** *When the Wizard is opened, the router will disconnect from the internet.*

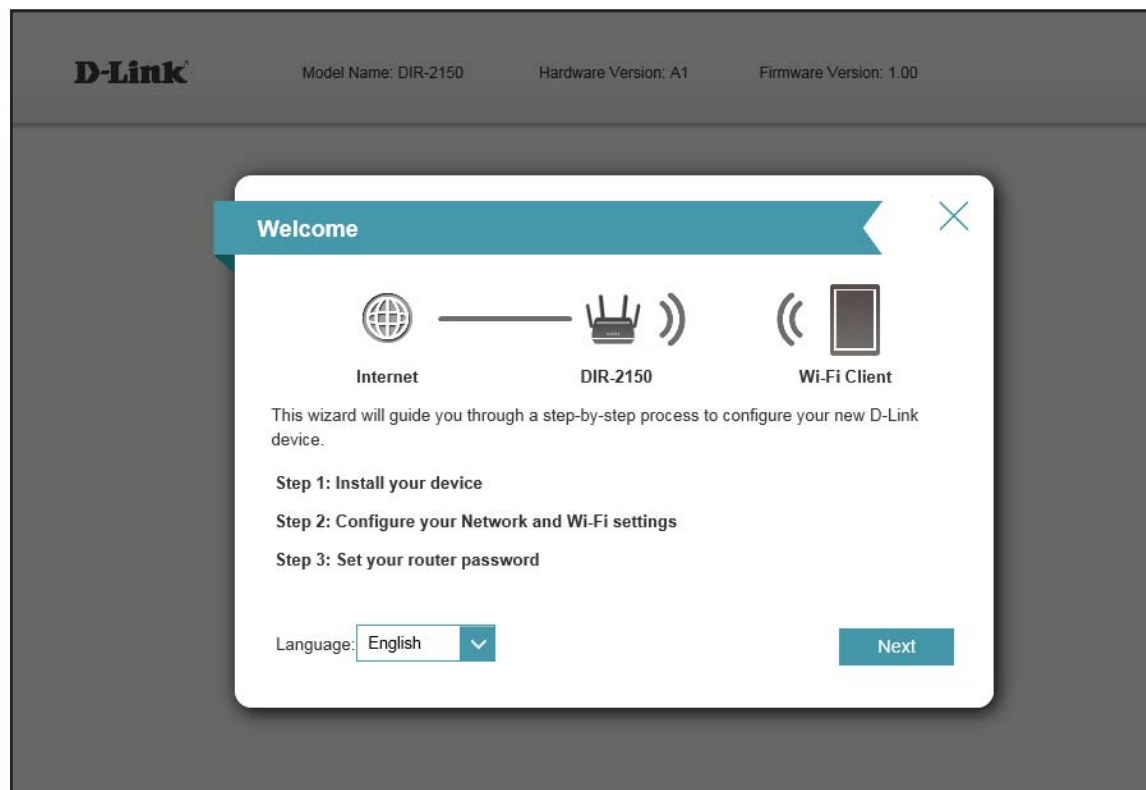

## Internet(WAN) - IPv4

In the Settings menu on the bar at the top of the page, click **Internet** to see the Internet configuration options for the IPv4 connection details.

To configure the IPv6 Internet and network connection details, click the **IPv6** link. Refer to **Internet - IPv6** on page **39**

To configure the VLAN connection details, click the **VLAN** link. Refer to **Internet - VLAN** on page **54**

Click **Save** at any time to save the changes you have made on this page.

**My Internet Connection is** Choose your Internet connection type from the drop-down menu. You will be presented with the appropriate options for your connection type.

For **IPv4 - Dynamic IP (DHCP)** refer to page **30**

For **IPv4 - Static IP** refer to page **31**

For **IPv4 - PPPoE** refer to page **32**

For **IPv4 - PPTP** refer to page **34**

For **IPv4 - L2TP** refer to page **36**

For **IPv4 - DS-Lite** refer to page **38**

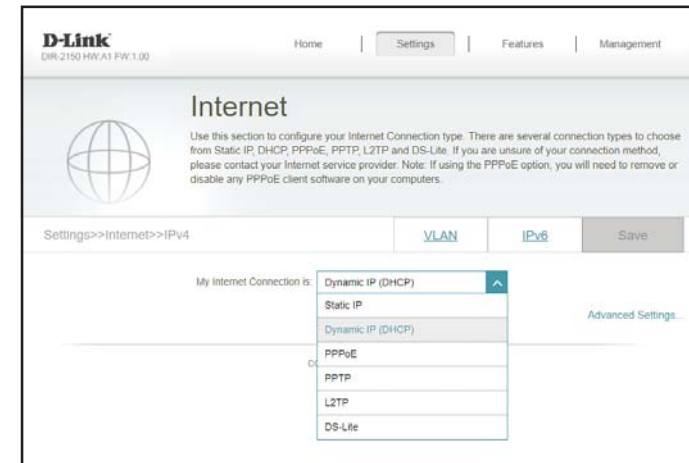

## IPv4 - Dynamic IP (DHCP)

Select **Dynamic IP (DHCP)** to obtain IP address information automatically from your Internet Service Provider (ISP). Select this option if your ISP does not specify an IP address to use. Click **Save** at any time to save the changes you have made on this page.

### Advanced Settings...

<b>Host Name</b>	The host name is optional but may be required by some ISPs. Leave it blank if you are not sure.
<b>Primary DNS Server</b>	Enter the primary DNS server IP address assigned by your ISP. This address is usually obtained automatically from your ISP.
<b>Secondary DNS Server</b>	Enter the secondary DNS server IP address assigned by your ISP. This address is usually obtained automatically from your ISP.
<b>MTU</b>	Maximum Transmission Unit - you may need to change the MTU for optimal performance with your ISP.
<b>MAC Address Clone</b>	The default MAC address is set to the Internet port's physical interface MAC address on the router. You can use the drop-down menu to replace the Internet port's MAC address with the MAC address of a connected client.

The screenshot shows the D-Link router's web interface for configuring the Internet connection. The page title is "Internet" and it includes a navigation menu with "Home", "Settings", "Features", and "Management". The breadcrumb trail is "Settings >> Internet >> IPv4". There are tabs for "VLAN" and "IPv6", and a "Save" button. The "My Internet Connection is:" dropdown menu is set to "Dynamic IP (DHCP)". Below this, there are input fields for "Host Name", "Primary DNS Server", "Secondary DNS Server", and "MTU" (set to 1500). The "MAC Address Clone" dropdown menu is set to "<< MAC Address". A "Save" button is located at the bottom right of the form area. The footer of the page reads "COPYRIGHT © 2016 D-Link".

## IPv4 - Static IP

Select **Static IP** if your IP information is provided by your Internet Service Provider (ISP). Click **Save** at any time to save the changes you have made on this page.

- IP Address** Enter the IP address provided by your ISP.
- Subnet Mask** Enter the subnet mask provided by your ISP.
- Default Gateway** Enter the default gateway address provided by your ISP.
- Primary DNS Server** Enter the primary DNS server IP address assigned by your ISP.

The screenshot shows the 'Internet' configuration page on a D-Link router. The navigation bar includes 'Home', 'Settings', 'Features', and 'Management'. The page title is 'Internet'. Below the title, there is a globe icon and a paragraph of instructions. The 'Settings' breadcrumb is 'Settings>>Internet>>IPv4'. There are tabs for 'VLAN', 'IPv6', and 'Save'. A dropdown menu shows 'My Internet Connection is: Static IP'. Below this are input fields for 'IP Address', 'Subnet Mask', 'Default Gateway', and 'Primary DNS Server'. An 'Advanced Settings...' link is at the bottom right. The footer says 'COPYRIGHT © 2016 D-Link'.

### Advanced Settings...

- Secondary DNS Server** Enter the secondary DNS server IP address assigned by your ISP.
- MTU** Maximum Transmission Unit - you may need to change the MTU for optimal performance with your ISP.
- MAC Address Clone** The default MAC address is set to the Internet port's physical interface MAC address on the router. You can use the drop-down menu to replace the Internet port's MAC address with the MAC address of a connected client.

The screenshot shows the 'Advanced Settings...' page. It features input fields for 'Secondary DNS Server', 'MTU' (with a value of 1500), and 'MAC Address Clone'. A dropdown menu next to 'MAC Address Clone' is set to '<< MAC Address'. The footer says 'COPYRIGHT © 2016 D-Link'.

## IPv4 - PPPoE

Select **PPPoE** if your ISP provides and requires you to enter a PPPoE username and password in order to connect to the Internet. Click **Save** at any time to save the changes you have made on this page.

**Username** Enter the username provided by your ISP.

**Password** Enter the password provided by your ISP.

**Reconnect Mode** Select either **Always on**, **On Demand**, or **Manual**.

**Maximum Idle Time** Configurable when **On Demand** is selected. Enter a maximum idle time during which the Internet connection is maintained during inactivity. To disable this feature, select **Always on** as the reconnect mode.

### Advanced Settings...

**Address Mode** Select **Static IP** if your ISP assigned you the IP address, subnet mask, gateway, and DNS server addresses. In most cases, select **Dynamic IP**.

### Advanced Settings... - Dynamic IP

- Address Mode** Shows your chosen address mode.
- Service Name** Enter the ISP service name (optional)
- Primary DNS Server** Enter the primary DNS server IP address assigned by your ISP.
- Secondary DNS Server** Enter the secondary DNS server IP address assigned by your ISP.
- MTU** Maximum Transmission Unit - you may need to change the MTU for optimal performance with your ISP.
- MAC Address Clone** The default MAC address is set to the Internet port's physical interface MAC address on the router. You can use the drop-down menu to replace the Internet port's MAC address with the MAC address of a connected client.

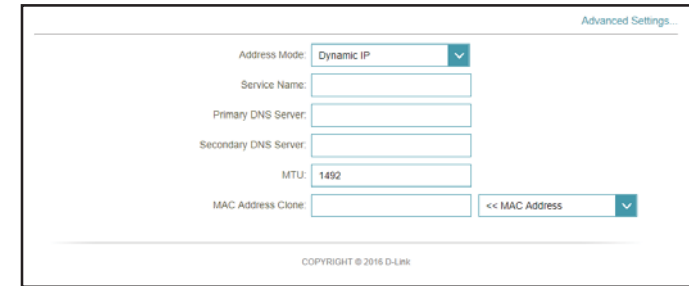

### Advanced Settings... - Static IP

- Address Mode** Displays your chosen address mode.
- IP Address** Enter the IP address provided by your ISP.
- Service Name** Enter the ISP service name (optional)
- Primary DNS Server** Enter the primary DNS server IP address assigned by your ISP.
- Secondary DNS Server** Enter the secondary DNS server IP address assigned by your ISP.
- MTU** Maximum Transmission Unit - you may need to change the MTU for optimal performance with your ISP.
- MAC Address Clone** The default MAC address is set to the Internet port's physical interface MAC address on the router. You can use the drop-down menu to replace the Internet port's MAC address with the MAC address of a connected client.

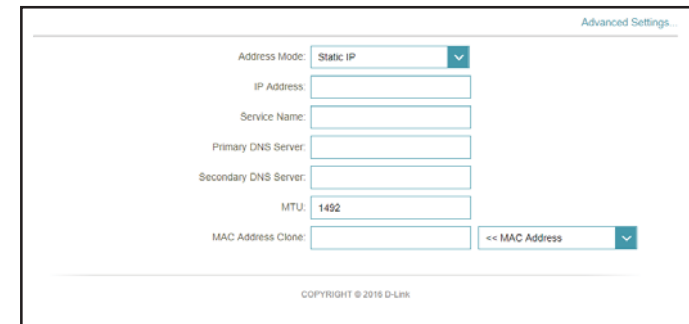

## IPv4 - PPTP

Choose **PPTP** (Point-to-Point-Tunneling Protocol) if your Internet Service Provider (ISP) uses a PPTP connection. Your ISP will provide you with a username and password. Click **Save** at any time to save the changes you have made on this page.

**PPTP Server** Enter the PPTP server IP address provided by your ISP.

**Username** Enter the username provided by your ISP.

**Password** Enter the password provided by your ISP.

**Reconnect Mode** Select either **Always on**, **On Demand**, or **Manual**.

**Maximum Idle Time** Configurable when **On Demand** is selected. Enter a maximum idle time during which the Internet connection is maintained during inactivity. To disable this feature, select **Always on** as the reconnect mode.

The screenshot shows the 'Internet' configuration page in the D-Link web interface. The page title is 'Internet' and it includes a navigation menu with 'Home', 'Settings', 'Features', and 'Management'. Below the title, there is a brief instruction: 'Use this section to configure your Internet Connection type. There are several connection types to choose from: Static IP, DHCP, PPPoE, PPTP, L2TP and DS-Lite. If you are unsure of your connection method, please contact your Internet service provider. Note: If using the PPPoE option, you will need to remove or disable any PPPoE client software on your computers.' The breadcrumb trail is 'Settings >> Internet >> IPv4'. There are three tabs: 'VLAN', 'IPv6', and 'Save'. The 'My Internet Connection is:' dropdown is set to 'PPTP'. Below this, there are input fields for 'PPTP Server: IP or Domain name:', 'Username:', and 'Password:'. The 'Reconnect Mode:' dropdown is set to 'On demand'. The 'Maximum Idle Time:' is set to '5 minutes'. There is a link for 'Advanced Settings...' and a copyright notice 'COPYRIGHT © 2016 D-Link' at the bottom.

### Advanced Settings...

**Address Mode** Select **Static IP** if your ISP assigned you the IP address, subnet mask, gateway, and DNS server addresses. In most cases, select **Dynamic IP**.

The screenshot shows the 'Advanced Settings...' page for IPv4. It features a dropdown menu for 'Address Mode' with 'Dynamic IP' selected. Below it, there are input fields for 'Primary DNS Server:' and 'Secondary DNS Server:', both with 'Dynamic IP' selected in their respective dropdown menus.

### Advanced Settings... - Dynamic IP

- Address Mode** Shows your chosen address mode.
- Primary DNS Server** Enter the primary DNS server IP address assigned by your ISP.
- Secondary DNS Server** Enter the secondary DNS server IP address assigned by your ISP.
- MTU** Maximum Transmission Unit - you may need to change the MTU for optimal performance with your ISP.

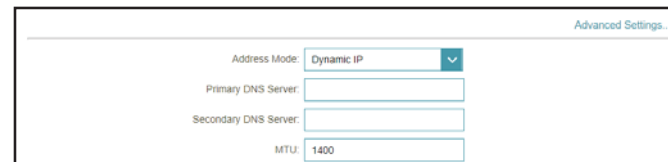

Advanced Settings...

Address Mode:

Primary DNS Server:

Secondary DNS Server:

MTU:

### Advanced Settings... - Static IP

- Address Mode** Displays your chosen address mode.
- PPTP IP Address** Enter the IP address provided by your ISP.
- PPTP Subnet Mask** Enter the subnet mask provided by your ISP.
- PPTP Gateway IP Address** Enter the gateway IP address provided by your ISP.
- Primary DNS Server** Enter the primary DNS server IP address assigned by your ISP.
- Secondary DNS Server** Enter the secondary DNS server IP address assigned by your ISP.
- MTU** Maximum Transmission Unit - you may need to change the MTU for optimal performance with your ISP.

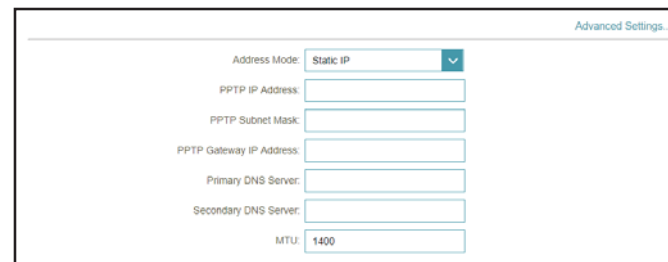

Advanced Settings...

Address Mode:

PPTP IP Address:

PPTP Subnet Mask:

PPTP Gateway IP Address:

Primary DNS Server:

Secondary DNS Server:

MTU:



## IPv4 - L2TP

Choose **L2TP** (Layer 2 Tunneling Protocol) if your Internet Service Provider (ISP) uses a L2TP connection. Your ISP will provide you with a username and password. Click **Save** at any time to save the changes you have made on this page.

- L2TP Server** Enter the L2TP server IP address provided by your ISP.
- Username** Enter the username provided by your ISP.
- Password** Enter the password provided by your ISP.
- Reconnect Mode** Select either **Always on**, **On Demand**, or **Manual**.
- Maximum Idle Time** Configurable when **On Demand** is selected. Enter a maximum idle time during which the Internet connection is maintained during inactivity. To disable this feature, select **Always on** as the reconnect mode.

### Advanced Settings...

- Address Mode** Select **Static IP** if your ISP assigned you the IP address, subnet mask, gateway, and DNS server addresses. In most cases, select **Dynamic IP**.

### Advanced Settings... - Dynamic IP

- Address Mode** Shows your chosen address mode.
- Primary DNS Server** Enter the primary DNS server IP address assigned by your ISP.
- Secondary DNS Server** Enter the secondary DNS server IP address assigned by your ISP.
- MTU** Maximum Transmission Unit - you may need to change the MTU for optimal performance with your ISP.

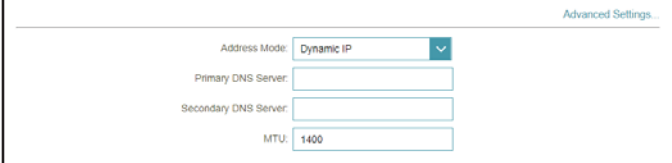

Advanced Settings...

Address Mode:

Primary DNS Server:

Secondary DNS Server:

MTU:

### Advanced Settings... - Static IP

- Address Mode** Shows your chosen address mode.
- L2TP IP Address** Enter the IP address provided by your ISP.
- L2TP Subnet Mask** Enter the subnet mask provided by your ISP.
- L2TP Gateway IP Address** Enter the gateway IP address provided by your ISP.
- Primary DNS Server** Enter the primary DNS server IP address assigned by your ISP.
- Secondary DNS Server** Enter the secondary DNS server IP address assigned by your ISP.
- MTU** Maximum Transmission Unit - you may need to change the MTU for optimal performance with your ISP.

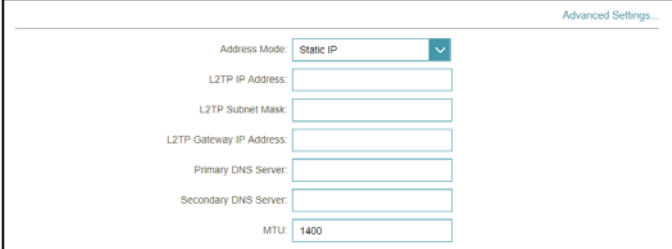

Advanced Settings...

Address Mode:

L2TP IP Address:

L2TP Subnet Mask:

L2TP Gateway IP Address:

Primary DNS Server:

Secondary DNS Server:

MTU:

## IPv4 - DS-Lite

**DS-Lite** is an IPv6 connection type. After selecting DS-Lite, the following parameters will be available for configuration. Click **Save** at any time to save the changes you have made on this page.

### Advanced Settings...

**DS-Lite Configuration** Select **DS-Lite DHCPv6 Option** to let the router allocate the AFTR IPv6 address automatically. Select **Manual Configuration** to enter the AFTR IPv6 address manually.

The screenshot shows the 'Internet' configuration page for a D-Link DIR-2150 HW v1 FW 1.00 router. The 'My Internet Connection is' dropdown is set to 'DS-Lite'. The 'DS-Lite Configuration' dropdown is set to 'DS-Lite DHCPv6 Option'. The 'B4 IPv4 Address' field is set to '192.0.0.' and the 'WAN IPv6 Address' field is 'Not Available'. The 'IPV6' tab is selected, and the 'Save' button is visible.

### Advanced Settings... - DS-Lite DHCPv6 Option

**B4 IPv4 Address** Enter the B4 IPv4 address value used here.

**WAN IPv6 Address** Once connected, the WAN IPv6 address will be displayed here.

**IPv6 Default WAN Gateway** Once connected, the IPv6 WAN default gateway address will be displayed here.

The screenshot shows the 'Advanced Settings...' section for the 'DS-Lite DHCPv6 Option' configuration. The 'DS-Lite Configuration' dropdown is set to 'DS-Lite DHCPv6 Option'. The 'B4 IPv4 Address' field is set to '192.0.0.' and the 'WAN IPv6 Address' and 'IPv6 WAN Default Gateway' fields are 'Not Available'.

### Advanced Settings... - Manual Configuration Option

**AFTR IPv6 Address** Enter the AFTR IPv6 address used here.

**B4 IPv4 Address** Enter the B4 IPv4 address value used here.

**WAN IPv6 Address** Once connected, the WAN IPv6 address will be displayed here.

**IPv6 WAN Default Gateway** Once connected, the IPv6 WAN default gateway address will be displayed here.

The screenshot shows the 'Advanced Settings...' section for the 'Manual Configuration' option. The 'DS-Lite Configuration' dropdown is set to 'Manual Configuration'. The 'AFTR IPv6 Address' field is empty, and the 'B4 IPv4 Address' field is set to '192.0.0.'. The 'WAN IPv6 Address' and 'IPv6 WAN Default Gateway' fields are 'Not Available'.

## Internet - IPv6

In the Settings menu on the bar at the top of the page, click **Internet** to see the Internet configuration options for the IPv4 connection details, then click the **IPv6** link to access the configuration options for the IPv6 connection details.

To configure the IPv4 Internet and network connection details, click the **IPv4** link. Refer to **Internet - IPv4** on page **29**

To configure the VLAN connection details, click the **VLAN** link. Refer to **Internet - VLAN** on page **54**

Click **Save** at any time to save the changes you have made on this page.

### My Internet Connection is

Choose your Internet connection type from the drop-down menu. You will be presented with the appropriate options for your connection type.

For **IPv6 - Auto Detection** refer to page **40**

For **IPv6 - Static IPv6** refer to page **42**

For **IPv6 - Auto Configuration (SLAAC/DHCPv6)** refer to page **44**

For **IPv6 - PPPoE** refer to page **47**

For **IPv6 - 6rd** refer to page **51**

For **IPv6 - Local Connectivity Only** refer to page **53**



## IPv6 - Auto Detection

Select **Auto Detection** to automatically detect the IPv6 connection method used by your Internet Service Provider (ISP). If Auto Detection fails, you can manually select another IPv6 connection type. Click **Save** at any time to save the changes you have made on this page.



### IPv6 DNS Settings

**DNS Type** Select either **Obtain DNS server address automatically** or **Use the following DNS address**.

**Primary DNS Server** If you selected **Use the following DNS address**, enter the primary DNS server address.

**Secondary DNS Server** If you selected **Use the following DNS address**, enter the secondary DNS server address.

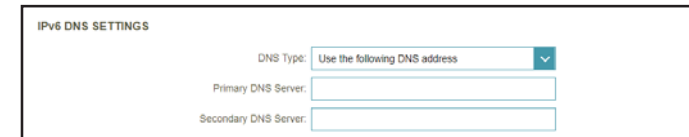

### LAN IPv6 Address Settings

**Enable DHCP-PD** Enable or disable DHCP Prefix Delegation.

**LAN IPv6 Link-Local Address** Displays the router's LAN link-local address.

If **Enable DHCP-PD** is disabled, these additional parameters are available for configuration:

**LAN IPv6 Address** Enter a valid LAN IPv6 address.

**LAN IPv6 Link-Local Address** Displays the router's LAN link-local address.



### Advanced Settings... - Address Autoconfiguration Settings

- Enable Automatic IPv6 Address Assignment**    Enable or disable the Automatic IPv6 Address Assignment feature.
- Enable Automatic DHCP-PD in LAN**    Enable or disable DHCP-PD for other IPv6 routers connected to the LAN interface.
- Autoconfiguration Type**    Select **SLAAC+RDNSS**, **SLAAC+Stateless DHCP**, or **Stateful DHCPv6**.

If you selected **SLAAC+RDNSS** or **SLAAC+Stateless DHCP** as the Autoconfiguration Type:

- Router Advertisement Lifetime**    Enter the router advertisement lifetime (in minutes).

If you selected **Stateful DHCPv6** as the Autoconfiguration Type:

- IPv6 Address Range (Start)**    Enter the starting IPv6 address for the DHCP server's IPv6 assignment.
- IPv6 Address Range (End)**    Enter the ending IPv6 address for the DHCP server's IPv6 assignment.

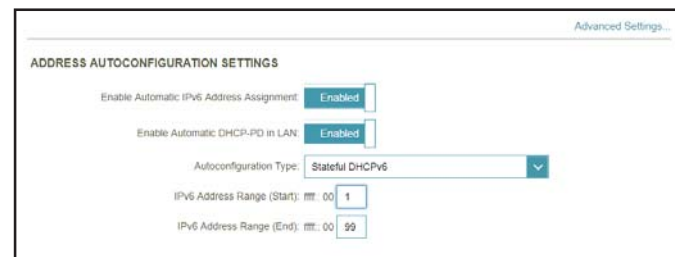
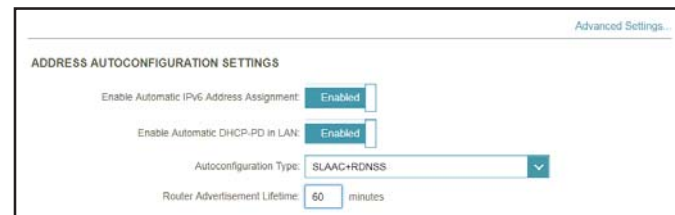
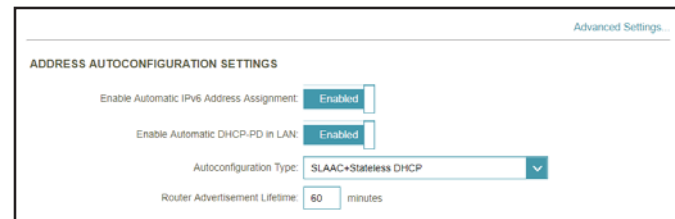

## IPv6 - Static IPv6

Select **Static IP** if your IPv6 information is provided by your Internet Service Provider (ISP). Click **Save** at any time to save the changes you have made on this page.

- Use Link-Local Address** Enable or disable link-local address use.
- IPv6 Address** Configurable when **Use Link-Local Address** is disabled. Enter the address supplied by your ISP.
- Subnet Prefix Length** Configurable when **Use Link-Local Address** is disabled. Enter the subnet prefix length supplied by your ISP.
- Default Gateway** Enter the default gateway for your IPv6 connection.
- Primary DNS Server** Enter the primary DNS server address.
- Secondary DNS Server** Enter the secondary DNS server address.

### LAN IPv6 Address Settings

- LAN IPv6 Address** Enter the LAN (local) IPv6 address for the router.
- LAN IPv6 Link-Local Address** Displays the router's LAN link-local address.

The screenshot displays the IPv6 configuration interface for a D-Link router. At the top, there are navigation links for Home, Settings, Features, and Management. The main heading is 'IPv6' with a sub-note: 'All of your IPv6 Internet and network connection details are displayed on this page.' Below this, there are tabs for 'VLAN', 'IPv4', and 'IPv6', with 'IPv6' being the active tab. A 'Save' button is located to the right of the tabs. The configuration area includes a dropdown menu for 'My Internet Connection is:' set to 'Static IPv6'. Below this are several input fields: 'Use Link-Local Address:' (set to 'Disabled'), 'IPv6 Address:', 'Subnet Prefix Length:', 'Default Gateway:', 'Primary DNS Server:', and 'Secondary DNS Server:'. At the bottom, there is a section for 'LAN IPv6 ADDRESS SETTINGS' with a 'LAN IPv6 Address:' field (containing '/64') and a 'LAN IPv6 Link-Local Address:' field (containing 'FE80:EB6:02FF:FE93:7CDB'). An 'Advanced Settings' link is located at the bottom right of the page.

### Advanced Settings... - Address Autoconfiguration Settings

**Enable Automatic IPv6 Address Assignment** Enable or disable the Automatic IPv6 Address Assignment feature.

**Autoconfiguration Type** Select **SLAAC+RDNSS**, **SLAAC+Stateless DHCP**, or **Stateful DHCPv6**.

*If you selected **SLAAC+RDNSS** or **SLAAC+Stateless DHCP** as the Autoconfiguration Type:*

**Router Advertisement Lifetime** Enter the router advertisement lifetime (in minutes).

*If you selected **Stateful DHCPv6** as the Autoconfiguration Type:*

**IPv6 Address Range (Start)** Enter the starting IPv6 address for the DHCP server's IPv6 assignment.

**IPv6 Address Range (End)** Enter the ending IPv6 address for the DHCP server's IPv6 assignment.

**IPv6 Address Lifetime** Enter the IPv6 address lifetime (in minutes).

The screenshot shows the 'ADDRESS AUTOCONFIGURATION SETTINGS' section. The 'Enable Automatic IPv6 Address Assignment' toggle is set to 'Enabled'. The 'Autoconfiguration Type' dropdown menu is set to 'SLAAC+Stateless DHCP'. The 'Router Advertisement Lifetime' is set to '30 minutes'.

The screenshot shows the 'ADDRESS AUTOCONFIGURATION SETTINGS' section. The 'Enable Automatic IPv6 Address Assignment' toggle is set to 'Enabled'. The 'Autoconfiguration Type' dropdown menu is set to 'SLAAC+RDNSS'. The 'Router Advertisement Lifetime' is set to '30 minutes'.

The screenshot shows the 'ADDRESS AUTOCONFIGURATION SETTINGS' section. The 'Enable Automatic IPv6 Address Assignment' toggle is set to 'Enabled'. The 'Autoconfiguration Type' dropdown menu is set to 'Stateful DHCPv6'. The 'IPv6 Address Range (Start)' and 'IPv6 Address Range (End)' fields are both set to 'fff: 00'. The 'IPv6 Address Lifetime' is set to '10080 minutes'.



## IPv6 - Auto Configuration (SLAAC/DHCPv6)

Select **Auto Configuration** if your ISP assigns your IPv6 address when your router requests one from the ISP's server. Some ISPs require you to adjust settings on your side before your router can connect to the IPv6 Internet. Click **Save** at any time to save the changes you have made on this page.



### IPv6 DNS Settings

**DNS Type** Select either **Obtain DNS server address automatically** or **Use the following DNS address**.

**Primary DNS Server** If you selected **Use the following DNS address**, enter the primary DNS server address.

**Secondary DNS Server** If you selected **Use the following DNS address**, enter the secondary DNS server address.

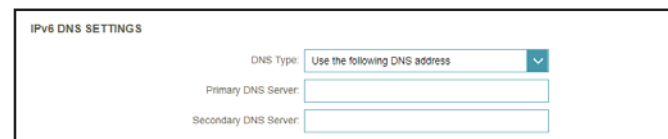

### LAN IPv6 Address Settings

**Enable DHCP-PD** Enable or disable prefix delegation services.

**LAN IPv6 Link-Local Address** Displays the router's LAN link-local address.

*If **Enable DHCP-PD** is disabled, these additional parameters are available for configuration:*

**LAN IPv6 Address** Enter a valid LAN IPv6 address.

**LAN IPv6 Link-Local Address** Displays the router's LAN link-local address.



### Advanced Settings... - Address Autoconfiguration Settings

**Enable Automatic IPv6 Address Assignment** Enable or disable the Automatic IPv6 Address Assignment feature.

If **Enable DHCP-PD** is enabled in the previous LAN IPv6 Address Settings:

**Enable Automatic DHCP-PD in LAN** Enable or disable DHCP-PD for other IPv6 routers connected to the LAN interface.

**Autoconfiguration Type** Select **SLAAC+RDNSS**, **SLAAC+Stateless DHCP**, or **Stateful DHCPv6**.

If you selected **SLAAC+RDNSS** or **SLAAC+Stateless DHCP** as the Autoconfiguration Type:

**Router Advertisement Lifetime** Enter the router advertisement lifetime (in minutes).

If you selected **Stateful DHCPv6** as the Autoconfiguration Type:

**IPv6 Address Range (Start)** Enter the starting IPv6 address for the DHCP server's IPv6 assignment.

**IPv6 Address Range (End)** Enter the ending IPv6 address for the DHCP server's IPv6 assignment.

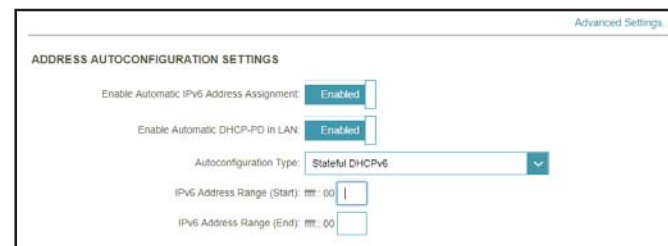
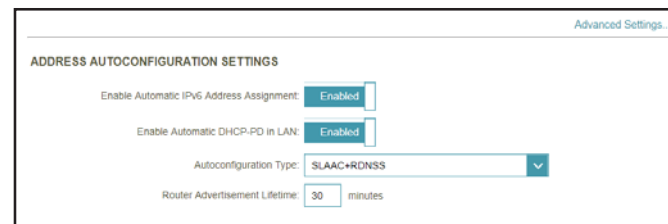
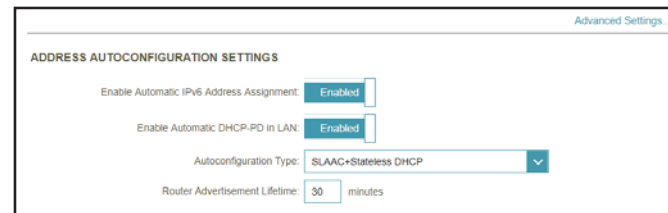

### Advanced Settings... - Address Autoconfiguration Settings

**Enable Automatic IPv6 Address Assignment** Enable or disable the Automatic IPv6 Address Assignment feature.

If **Enable DHCP-PD** is disabled in the previous LAN IPv6 Address Settings:

**Autoconfiguration Type** Select **SLAAC+RDNSS**, **SLAAC+Stateless DHCP**, or **Stateful DHCPv6**.

If you selected **SLAAC+RDNSS** or **SLAAC+Stateless DHCP** as the Autoconfiguration Type:

**Router Advertisement Lifetime** Enter the router advertisement lifetime (in minutes).

If you selected **Stateful DHCPv6** as the Autoconfiguration Type:

**IPv6 Address Range (Start)** Enter the starting IPv6 address for the DHCP server's IPv6 assignment.

**IPv6 Address Range (End)** Enter the ending IPv6 address for the DHCP server's IPv6 assignment.

**IPv6 Address Lifetime** Enter the IPv6 address lifetime (in minutes).

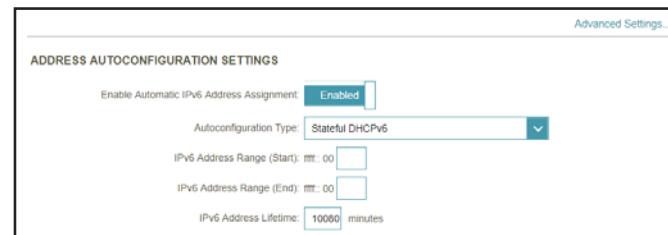
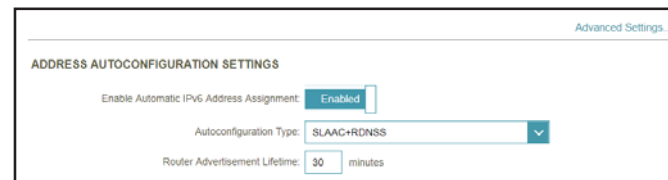
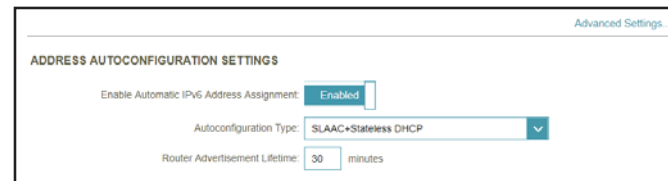

## IPv6 - PPPoE

Select **PPPoE** if your ISP provides and requires you to enter a PPPoE username and password in order to connect to the Internet. Click **Save** at any time to save the changes you have made on this page.

- PPPoE Session** Create a new PPPoE session.
- Username** Enter the username provided by your ISP.
- Password** Enter the password provided by your ISP.
- Address Mode** Select either **Dynamic IP** or **Static IP**.
- IP Address** Configurable if Static IP is chosen. Enter the IP address provided by your ISP.
- Service Name** Enter the ISP service name (optional).
- Reconnect Mode** Select either **Always On** or **Manual**.
- MTU** Maximum Transmission Unit - you may need to change the MTU for optimal performance with your ISP.



The screenshot shows the D-Link IPv6 configuration interface. The page title is "IPv6" and it includes a navigation menu with "Home", "Settings", "Features", and "Management". The main content area is titled "IPv6" and contains a sub-menu with "VLAN", "IPv4", and "Save". The configuration form includes the following fields:

- My Internet Connection is: **PPPoE** (dropdown)
- PPPoE Session: **Create a new session** (dropdown)
- Username: [text input]
- Password: [text input]
- Address Mode: **Static IP** (dropdown)
- IP Address: [text input]
- Service Name: [text input]
- Reconnect Mode: **Always on** (dropdown)
- MTU: **1492** bytes

### IPv6 DNS Settings

**DNS Type** Select either **Obtain DNS server address automatically** or **Use the following DNS address**.

**Primary DNS Server** If you selected **Use the following DNS address**, enter the primary DNS server address.

**Secondary DNS Server** If you selected **Use the following DNS address**, enter the secondary DNS server address.

IPv6 DNS SETTINGS

DNS Type: Obtain a DNS server address automatically

IPv6 DNS SETTINGS

DNS Type: Use the following DNS address

Primary DNS Server: [ ]

Secondary DNS Server: [ ]

### LAN IPv6 Address Settings

**Enable DHCP-PD** Enable or disable prefix delegation services.

**LAN IPv6 Link-Local Address** Displays the router's LAN link-local address.

*If **Enable DHCP-PD** is disabled, these additional parameters are available for configuration:*

**LAN IPv6 Address** Enter a valid LAN IPv6 address.

**LAN IPv6 Link-Local Address** Displays the router's LAN link-local address.

LAN IPv6 ADDRESS SETTINGS

Enable DHCP-PD: Enabled

LAN IPv6 Link-Local Address: FE80:EB6:D2FF:FE93:7CD8

[Advanced Settings...](#)

LAN IPv6 ADDRESS SETTINGS

Enable DHCP-PD: Disabled

LAN IPv6 Address: [ ] :%4

LAN IPv6 Link-Local Address: FE80:EB6:D2FF:FE93:7CD8

[Advanced Settings...](#)

### Advanced Settings... - Address Autoconfiguration Settings

**Enable Automatic IPv6 Address Assignment** Enable or disable the Automatic IPv6 Address Assignment feature.

If **Enable DHCP-PD** is enabled in the previous LAN IPv6 Address Settings:

**Enable Automatic DHCP-PD in LAN** Enable or disable DHCP-PD for other IPv6 routers connected to the LAN interface.

**Autoconfiguration Type** Select **SLAAC+RDNSS**, **SLAAC+Stateless DHCP**, or **Stateful DHCPv6**.

If you selected **SLAAC+RDNSS** or **SLAAC+Stateless DHCP** as the Autoconfiguration Type:

**Router Advertisement Lifetime** Enter the router advertisement lifetime (in minutes).

If you selected **Stateful DHCPv6** as the Autoconfiguration Type:

**IPv6 Address Range (Start)** Enter the starting IPv6 address for the DHCP server's IPv6 assignment.

**IPv6 Address Range (End)** Enter the ending IPv6 address for the DHCP server's IPv6 assignment.

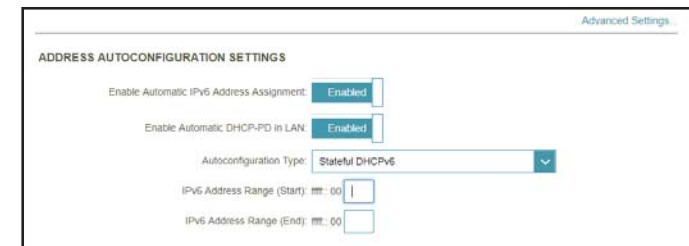
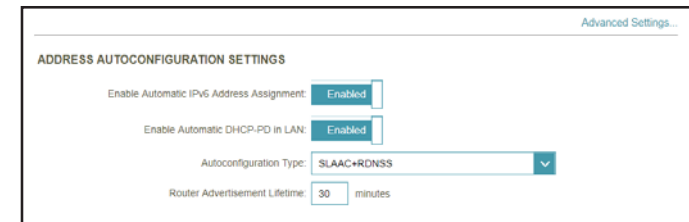
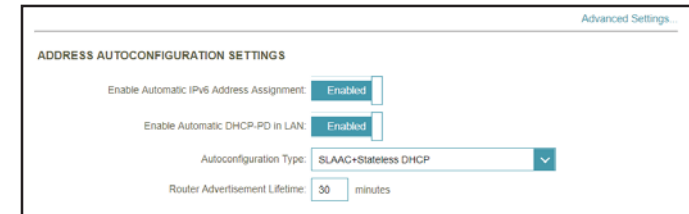

### Advanced Settings... - Address Autoconfiguration Settings

**Enable Automatic IPv6 Address Assignment** Enable or disable the Automatic IPv6 Address Assignment feature.

If **Enable DHCP-PD** is disabled in the previous LAN IPv6 Address Settings:

**Autoconfiguration Type** Select **SLAAC+RDNSS**, **SLAAC+Stateless DHCP**, or **Stateful DHCPv6**.

If you selected **SLAAC+RDNSS** or **SLAAC+Stateless DHCP** as the Autoconfiguration Type:

**Router Advertisement Lifetime** Enter the router advertisement lifetime (in minutes).

If you selected **Stateful DHCPv6** as the Autoconfiguration Type:

**IPv6 Address Range (Start)** Enter the starting IPv6 address for the DHCP server's IPv6 assignment.

**IPv6 Address Range (End)** Enter the ending IPv6 address for the DHCP server's IPv6 assignment.

**IPv6 Address Lifetime** Enter the IPv6 address lifetime (in minutes).

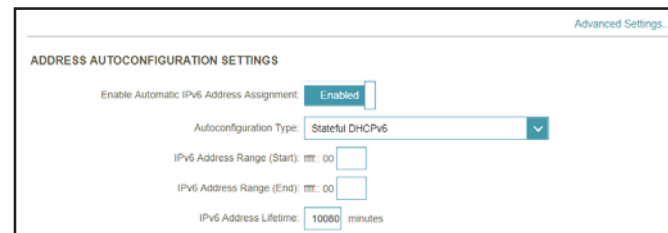
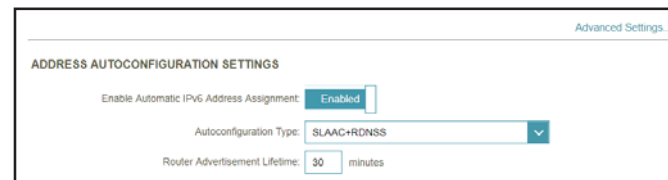
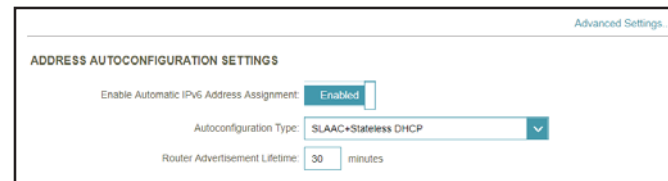

## IPv6 - 6rd

In this section the user can configure the IPv6 **6rd** connection settings. Click **Save** at any time to save the changes you have made on this page.

- Assign IPv6 Prefix**      Currently unsupported.
- Primary DNS Server**    Enter the primary DNS server address.
- Secondary DNS Server**   Enter the secondary DNS server address.

### 6rd Manual Configuration

**Enable Hub and Spoke Mode**    Enable this option if you want to minimize the number of routes to the destination by using a hub and spoke method of networking.

**6rd Configuration**            Choose the **6rd DHCPv4 Option** to automatically discover and populate the data values, or **Manual Configuration** to enter the settings yourself.

*If you selected **Manual Configuration** as the 6rd Configuration:*

- 6rd IPv6 Prefix**            Enter the 6rd IPv6 prefix and mask length supplied by your ISP.
- WAN IPv4 Address**        Displays the router's IPv4 address.
- 6rd Border Relay IPv4 Address**   Enter the 6rd border relay IPv4 address settings supplied by your ISP.



### LAN IPv6 Address Settings

**LAN IPv6 Address** Displays the router's LAN IPv6 Address link-local address.

**LAN IPv6 Link-Local Address** Displays the router's LAN link-local address.



### Advanced Settings... - Address Autoconfiguration Settings

**Enable Automatic IPv6 Address Assignment** Enable or disable the Automatic IPv6 Address Assignment feature.

**Autoconfiguration Type** Select **SLAAC+RDNSS**, **SLAAC+Stateless DHCP**, or **Stateful DHCPv6**.

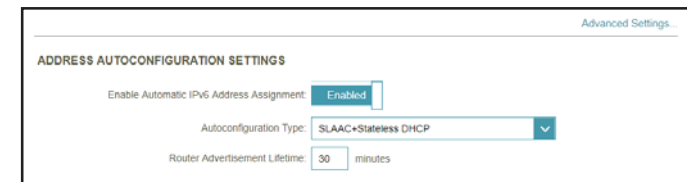

If you selected **SLAAC+RDNSS** or **SLAAC+Stateless DHCP** as the Autoconfiguration Type:

**Router Advertisement Lifetime** Enter the router advertisement lifetime (in minutes).

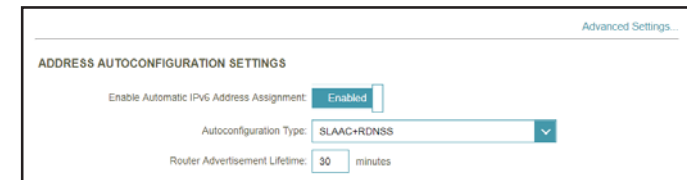

If you selected **Stateful DHCPv6** as the Autoconfiguration Type:

**IPv6 Address Range (Start)** Enter the starting IPv6 address for the DHCP server's IPv6 assignment.

**IPv6 Address Range (End)** Enter the ending IPv6 address for the DHCP server's IPv6 assignment.

**IPv6 Address Lifetime** Enter the IPv6 address lifetime (in minutes).

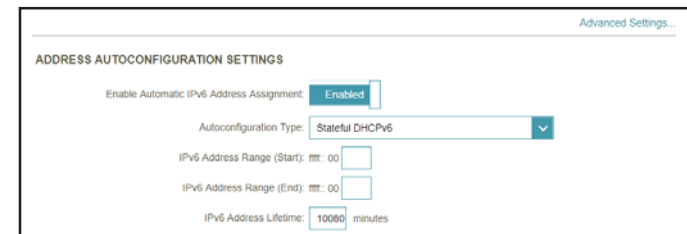

## IPv6 - Local Connectivity Only

**Local Connectivity Only** allows you to set up an IPv6 connection that will not connect to the Internet. Click **Save** at any time to save the changes you have made on this page.



### Advanced Settings... - IPv6 ULA Settings

**Enable ULA** Click here to enable Unique Local IPv6 Unicast Addresses settings.

**Use Default ULA Prefix** Enable this option to use the default ULA prefix.

**ULA Prefix** Configurable if you disable Use Default ULA Prefix. Enter your own ULA prefix.

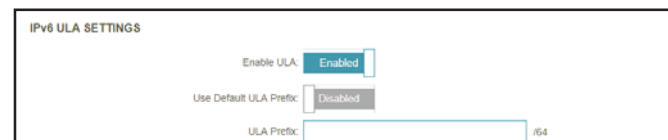

### Advanced Settings... - Current IPv6 ULA Settings

**Current ULA Prefix** Displays the current ULA prefix.

**LAN IPv6 ULA** Displays the LAN's IPv6 ULA.



## Internet - VLAN

In the Settings menu on the bar at the top of the page, click **Internet** to see the Internet configuration options for the IPv4 connection details, then click the **VLAN** link to access the configuration options for the VLAN connection details.

VLAN allows for services such as Triple-Play to be used, and divides a network into segments that can only be accessed by other devices in the same VLAN.

To configure the IPv4 Internet and network connection details, click the **IPv4** link. Refer to **Internet - IPv4** on page **29**

To configure the IPv6 Internet and network connection details, click the **IPv6** link. Refer to **Internet - IPv6** on page **39**

Click **Save** at any time to save the changes you have made on this page.

**Status** Click to enable or disable the Triple-Play VLAN feature. More configuration options will be available if the Status is enabled.



If Triple-Play Status is **Enabled**:

- Internet VLAN ID** Enter the VLAN ID for your Internet connection, as provided by your ISP.
- IPTV VLAN ID** Enter the VLAN ID for your IPTV service, as provided by your ISP.
- VOIP VLAN ID** Enter the VLAN ID for your VoIP network, as provided by your ISP.

### Interface Traffic Type Setting

- LAN Port 1-4** From the drop-down menu, you can select the type of connection (Internet, IPTV, or Voice over IP) coming from the WAN connection to each interface on the router.

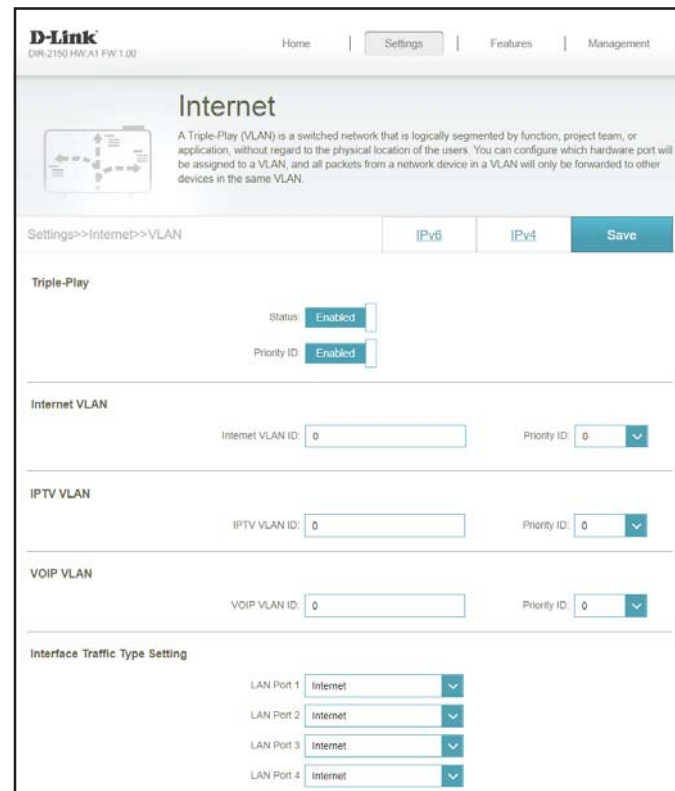

## Wireless(Wi-Fi)

In the Settings menu on the bar at the top of the page, click **Wireless** to see your wireless network settings for your DIR-1260.

Click **Save** at any time to save the changes you have made on this page.

### Smart Connect

**Status** Enable or disable the Smart Connect Feature. When enabled, only a few configuration options are available to simplify configuration.

If Smart Connect Status is **Enabled**:

### Wireless

**Wi-Fi Name (SSID)** Create a name for your wireless network using up to 32 characters.

**Password** Create a password to use for wireless security. Wireless clients will need to enter this password to successfully connect to the network.

### Wireless - Advanced Settings...

**Security Mode** Choose **None** or **WPA/WPA2-Personal** (recommended) or **WPA2/WPA3-Personal**.

**Transmission Power** Select the desired wireless transmission power.

**Schedule** Use the drop-down menu to select the time schedule that the rule will be enabled for. The schedule may be set to Always Enable, or you can create your own schedules in the Schedules section. Refer to **Time & Schedule - Schedule** on page **83** for more information.

The screenshot shows the configuration page for Smart Connect and Wireless settings. At the top, the 'Smart Connect' status is set to 'Enabled'. Below this, the 'Wireless' section contains the following fields:

- Wi-Fi Name (SSID):** RouterName
- Password:** AStrongPassword
- Security Mode:** WPA/WPA2-Personal (dropdown menu)
- Transmission Power:** High (dropdown menu)
- Schedule:** Always Enable (dropdown menu)

An 'Advanced Settings...' link is visible to the right of the Password field.

### Smart Connect

**Status** Enable or disable the Smart Connect Feature. When disabled, 2.4GHz and 5GHz configuration options become available.

If Smart Connect Status is **Disabled**:

### 2.4GHz / 5GHz

**Status** Enable or disable the 2.4GHz / 5GHz wireless network.

**Wi-Fi Name (SSID)** Create a name for your wireless network using up to 32 characters.

**Password** Create a password to use for wireless security. Wireless clients will need to enter this password to successfully connect to the network.

Smart Connect

Status:  Enabled  Disabled

2.4GHz

Status:  Enabled  Disabled

Wi-Fi Name (SSID):

Password:

5GHz

Status:  Enabled  Disabled

Wi-Fi Name (SSID):

Password:

## 2.4GHz / 5GHz - Advanced Settings...

**Security Mode** Choose **None** or **WPA/WPA2-Personal** (recommended) or **WPA2/WPA3-Personal**.

**802.11 Mode (2.4GHz)** Select the desired wireless networking standards to use. The available options for the 2.4 GHz wireless network are **Mixed 802.11b/g/n**, **Mixed 802.11g/n**, or **802.11n only**.

**802.11 Mode (5GHz)** Select the desired wireless networking standards to use. The available options for the 5 GHz wireless network are **Mixed 802.11a/n/ac**, **Mixed 802.11n/ac**, **Mixed 802.11a/n**, **802.11ac only**, **Mixed 802.11a only**, or **802.11n only**.

**Wi-Fi Channel** Select the desired channel. The default is **Auto** (recommended).

**Transmission Power** Select the desired wireless transmission power.

**Channel Width (2.4GHz)** Select **Auto 20/40** if you are using both 802.11n and non-802.11n devices, or select **20 MHz** if you are not using any 802.11n devices.

**Channel Width (5GHz)** Select **Auto 20/40/80** if you are using 802.11ac, 802.11n, and 802.11a devices, select **Auto 20/40** if you are using 802.11n and 802.11a devices, or select **20 MHz** if you are using 802.11a devices.

**Coexistence (2.4GHz)** Enable or disable HT20/40 Coexistence.

**Visibility Status** The default setting is **Visible**. Select **Invisible** if you do not want to broadcast the SSID of your wireless network.

**Schedule** Use the drop-down menu to select the time schedule that the rule will be enabled for. The schedule may be set to **Always Enable**, or you can create your own schedules in the **Schedules** section. Refer to **Time & Schedule - Schedule** on page **83** for more information.

2.4GHz

Status:  Enabled

Wi-Fi Name (SSID):

Password:

[Advanced Settings...](#)

Security Mode:

802.11 Mode:

Wi-Fi Channel:

Transmission Power:

Channel Width:

HT20/40 Coexistence:  Enabled

Visibility Status:

[Schedule:](#)

5GHz

Status:  Enabled

Wi-Fi Name (SSID):

Password:

[Advanced Settings...](#)

Security Mode:

802.11 Mode:

Wi-Fi Channel:

Transmission Power:

Channel Width:

Visibility Status:

[Schedule:](#)

## Wi-Fi Protected Setup

*The easiest way to connect your wireless devices to the router is with Wi-Fi Protected Setup (WPS).*

**WPS-PBC Status** Enable or disable WPS-PBC (Push Button Configuration) functionality.





## Guest Zone

In the Settings menu on the bar at the top of the page, click **Wireless** to see your wireless network settings for your DIR-1260. Then click the link to **Guest Zone** to configure your guest zone settings.

The **Guest Zone** feature will allow you to create temporary zones that can be used by guests to access the Internet. These zones will be separate from your main wireless network. You may configure different zones for the 2.4 GHz and 5 GHz wireless bands.

Click **Save** at any time to save the changes you have made on this page.

If Smart Connect Status is **Enabled** in the previous Wireless settings:

### Wireless

**Status** Enable or disable the Guest Zone feature. The status is disabled by default.

**Wireless Name (SSID)** Create a name for your wireless network using up to 32 characters.

**Password** Create a password to use for wireless security.

**Schedule** Use the drop-down menu to select the time schedule that the rule will be enabled for. The schedule may be set to **Always Enable**, or you can create your own schedules in the **Schedules** section. Refer to **Time & Schedule - Schedule** on page **83** for more information.

### Home Network Access

**Internet Access Only** Enabling this option will confine connectivity to the Internet, preventing guests from accessing other local network devices.

The screenshot displays the D-Link web interface for configuring the Guest Zone. At the top, there are navigation links for Home, Settings, Features, and Management. The main heading is 'Guest Zone' with a sub-heading: 'This page lets you enable and configure a Wi-Fi Guest Zone. Users connected to a Guest Zone cannot communicate or detect devices on your home network unless Internet Access Only is disabled under Home Network Access.' Below this, there is a breadcrumb trail 'Settings >> Wireless >> Guest Zone' and a 'Save' button. The 'Wireless' section contains:
 

- Status: Enabled (checkbox)
- Wi-Fi Name (SSID): dlink-guest (text input)
- Password: abcde66666 (password input)
- Schedule: Always Enable (dropdown menu)

 The 'Home Network Access' section contains:
 

- Internet Access Only: Enabled (checkbox)

If Smart Connect is Status is **Disabled** in the previous Wireless settings:

### 2.4 GHz / 5GHz

**Status** Enable or disable the Guest Zone feature. The status is disabled by default.

**Wireless Name (SSID)** Create a name for your wireless network using up to 32 characters.

**Password** Create a password to use for wireless security.

**Schedule** Use the drop-down menu to select the time schedule that the rule will be enabled for. The schedule may be set to **Always Enable**, or you can create your own schedules in the **Schedules** section. Refer to **Time & Schedule - Schedule** on page **83** for more information.

### Home Network Access

**Internet Access Only** Enabling this option will confine connectivity to the Internet, preventing guests from accessing other local network devices.

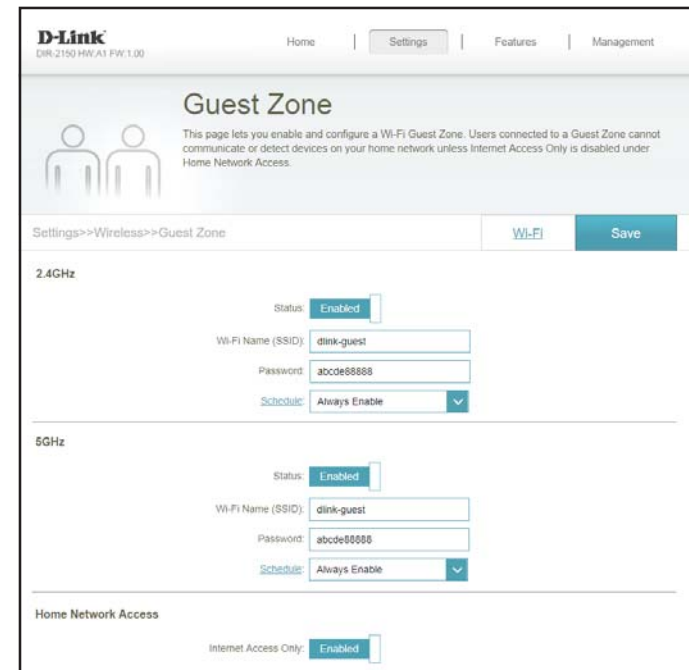

## Network(LAN)

In the Settings menu on the bar at the top of the page, click **Network** to change the local network settings of the router and to configure the DHCP settings.

Click **Save** at any time to save the changes you have made on this page.

### Network Settings

**LAN IP Address** Enter the IP address of the router. The default IP address is **192.168.0.1**. If you change the IP address, once you click **Save**, you will need to enter the new IP address in your browser to get back into the configuration utility.

**Subnet Mask** Enter the subnet mask of the router. The default subnet mask is **255.255.255.0**.

**Management Link** The default address to access the router's configuration is **http://dlinkrouter.local/**. You can replace **dlinkrouter** with a name of your choice.

**Local Domain Name** Enter the domain name (optional).

**Enable DNS Relay** Disable to transfer the DNS server information from your ISP to your computers. If enabled, your computers will use the router for a DNS server.

The screenshot displays the D-Link Network Settings page. At the top, there is a navigation bar with 'Home', 'Settings', 'Features', and 'Management'. Below the navigation bar, the 'Network' section is highlighted. A small icon of a computer monitor is shown next to the section title. Below the icon, there is a brief instruction: 'Use this section to configure the network settings for your device. You can enter a name for your device in the management link field, and use the link to access web UI in a web browser. We recommend you change the management link if there are more than one D-Link devices within the network.' Below this instruction, there is a 'Save' button. The main content area is titled 'Network Settings' and contains several input fields: 'LAN IP Address' with the value '192.168.0.1', 'Subnet Mask' with the value '255.255.255.0', 'Management Link' with the value 'http://dlinkrouter.local/', 'Local Domain Name' (empty), and 'Enable DNS Relay' with a dropdown menu set to 'Enabled'. At the bottom right of the form, there is a link for 'Advanced Settings...'. The breadcrumb 'Settings>>Network' is visible in the top left of the form area.

### DHCP Server

- Status** Enable or disable the DHCP server.
- DHCP IP Address Range** Enter the starting and ending IP addresses for the DHCP server's IP assignment. **Note:** *If you statically assign IP addresses to your computers or devices, make sure the IP addresses are outside of this range or you may have an IP conflict.*
- DHCP Lease Time** Enter the length of time for the IP address lease in minutes.
- Always Broadcast** Enable this feature to broadcast your network's DHCP server to LAN/WLAN clients.

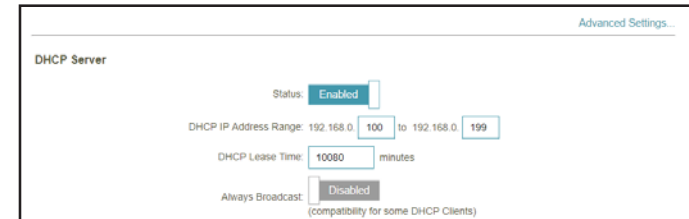

### Advanced Settings

- WAN Port Speed** You may set the port speed of the Internet port to **10 Mbps**, **100 Mbps**, **1000 Mbps**, or **Auto** (recommended).
- UPnP** Enable or disable Universal Plug and Play (UPnP). UPnP provides compatibility with networking equipment, software, and peripherals.
- IPv4 Multicast Streams** Enable to allow IPv4 multicast traffic to pass through the router from the Internet. This is enabled by default.
- IPv6 Multicast Streams** Enable to allow IPv6 multicast traffic to pass through the router from the Internet. This is enabled by default.

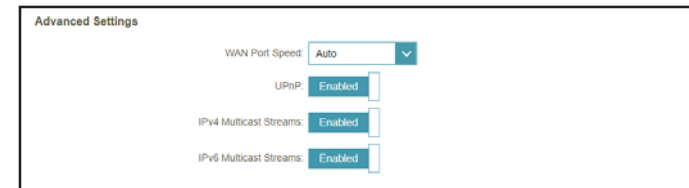

# Features

## Parental Control

In the Features menu on the bar at the top of the page, click **Parental Control** to configure connected clients Internet access.

Click **Save** at any time to save the changes you have made on this page.

If you wish to remove a rule, click on the trash can icon in the Delete column. If you wish to edit a rule, click on the pencil icon in the Edit column. If you wish to create a new rule, click the **Add Profile** button.

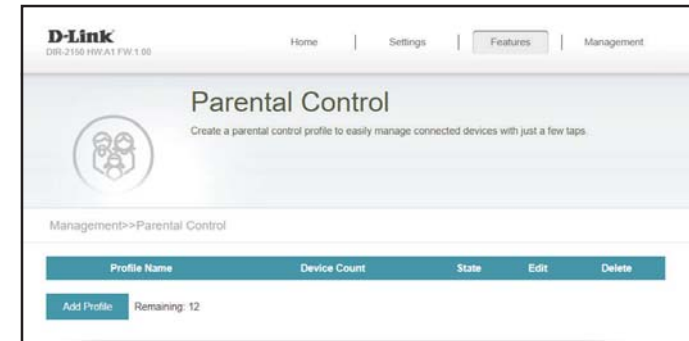

**Profile Name** Enter a profile name for the schedule..

### Schedule

**Schedule(Set Schedule when you want to be online)** Set a time period for the device to be allowed Internet access.

**Bedtime Schedule(Set a bedtime for time away from the internet)** Set a time period for the device to be denied Internet access.

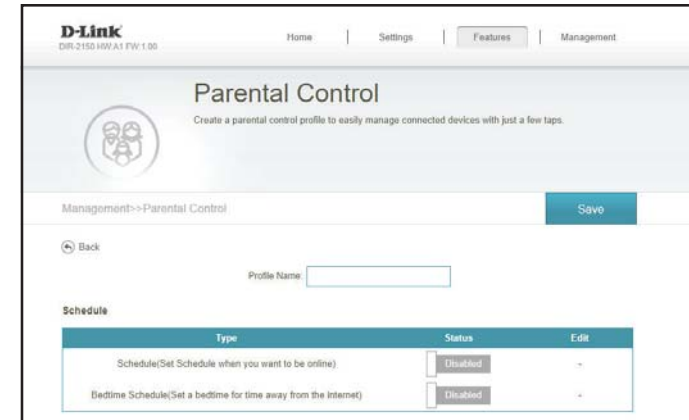

If Schedule or Bedtime Schedule Status is **Enabled**.

Click on the pencil icon in the Edit column if you wish to create a new schedule,.

Each box represents one hour, with the time at the top of each column. To add a time period to the schedule, simply click on the starting hour and drag to the ending hour. You can add multiple days to the schedule and multiple periods per day.

Click **Apply** when you are done.

Type	Status	Edit
Schedule(Set Schedule when you want to be online)	Enabled	
Bedtime Schedule(Set a bedtime for time away from the internet)	Enabled	

Schedule ✕

	0	1	2	3	4	5	6	7	8	9	10	11	12	13	14	15	16	17	18	19	20	21	22	23
Mon																								
Tue																								
Wed																								
Thu																								
Fri																								
Sat																								
Sun																								

■ Schedule ■ Bedtime Schedule

**Apply**

### Website Filter

If you wish to remove a Website Name/URL Keyword, click on the trash can icon in the Delete column. If you wish to list a new Website Name/Keyword to deny access to, click the **Add Rule** button.

**Website Name:** Enter a Website name that you wish to deny access to.

**URL Keyword:** Enter a URL Keyword name that you wish to deny access to.

Website Name	URL Keyword	Edit	Delete
Add Rule	Remaining: 24		

Add Rule ✕

Website Name:

URL Keyword:

**Apply**

### Device

Click the **Add Device** button to select the devices that you wish to add to the schedule

Device

Selected Devices

**Add Device** Remaining: 24

# QoS Engine

In the Features menu on the bar at the top of the page, click **QoS Engine** to configure connected clients Internet access priority.

Click **Save** at any time to save the changes you have made on this page.

**Management Type** Use the drop-down menu to select the Management Type that the rule will be enabled for. This may be set to **Off** or **Manage By Device**.

**Download Speed (Mbps)** Set the download speed based on your ISP subscription plan in order to adjust the QoS engine.

**Upload Speed (Mbps)** Set the upload speed based on your ISP subscription plan in order to adjust the QoS engine.

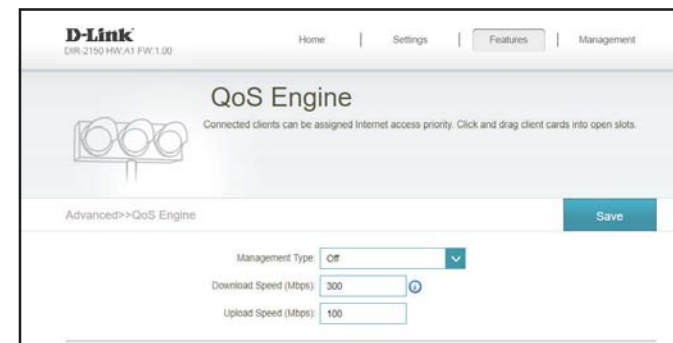

This **Quality of Service (QoS) Engine** will allow you to prioritize particular clients over others, so that those clients receive higher bandwidth. For example, if one client is streaming a movie and another is downloading a non-urgent file, you might wish to assign the former device a higher priority than the latter so that the movie streaming is not disrupted by the traffic of the other devices on the network.

Under **Connected Clients**, you will see device cards representing each connected client. If some are off-screen, you can use the < and > buttons to scroll through the cards.

A maximum of **one** device can be assigned **Highest** priority.

A maximum of **two** devices can be assigned **High** priority.

A maximum of **eight** devices can be assigned **Medium** priority.

If no devices are explicitly assigned a priority, they will all be treated with equal priority. If some devices are not assigned a priority and others are, the unassigned devices will be treated with the lowest priority.

To assign a priority level to a device, drag the device card from the All Devices list over an empty slot and release the mouse button. The card will remain in the slot. If you want to remove a priority assignment from a device and return it to the All Devices list, click the cross icon in the top right of the device card.

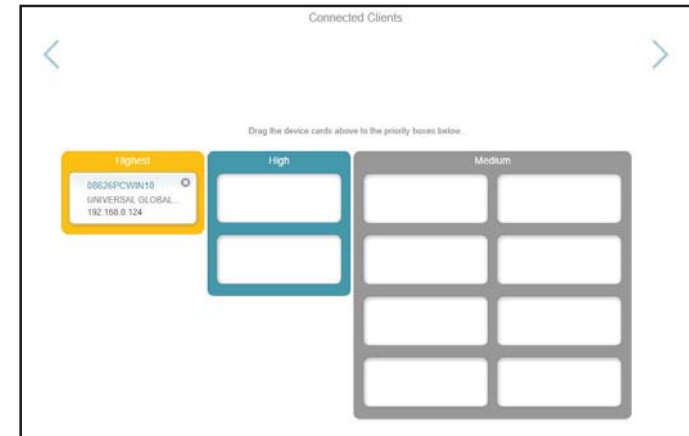



## Firewall Settings - Advanced

In the Features menu on the bar at the top of the page, click **Firewall** to configure the router's firewall settings. The firewall feature protects your network from malicious attacks over the Internet.

To configure the IPv4 firewall rules, click the **IPv4 Rules** link. Refer to **Firewall Settings - IPv4/IPv6 Rules** on page 70

To configure the IPv6 firewall rules, click the **IPv6 Rules** link. Refer to **Firewall Settings - IPv4/IPv6 Rules** on page 70

Click **Save** at any time to save the changes you have made on this page.

**Enable DMZ** Enable or disable Demilitarized Zone (DMZ). This completely exposes the client to threats over the Internet, and is not recommended in ordinary situations.

**DMZ IP Address** If you enabled DMZ, enter the IP address of the client you wish to expose, or use the drop-down menu to quickly select it.

**Enable SPI IPv4** Enabling Stateful Packet Inspection (SPI) helps to prevent cyber attacks by validating that the traffic passing through the session conforms to the protocol.

**Enable Anti-spoof Checking** Enable this feature to help protect your network from certain kinds of "spoofing" attacks.

**IPv6 Simple Security** Enable or disable IPv6 simple security.

**IPv6 Ingress Filtering** Enable or disable IPv6 ingress filtering.

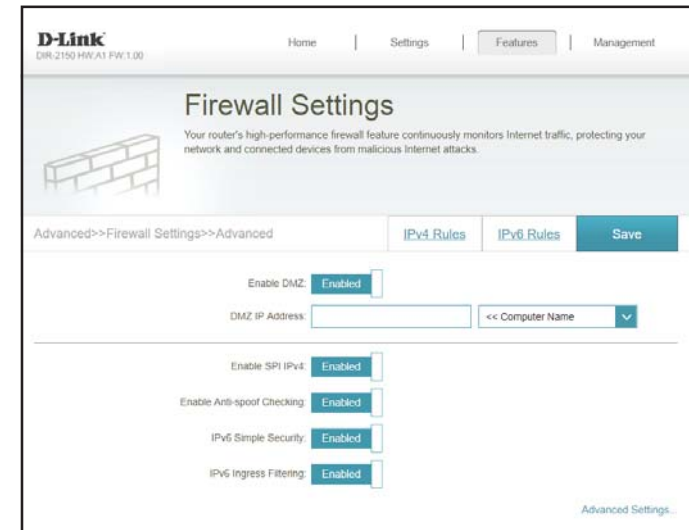

## Advanced Settings... - Application Level Gateway (ALG) Configuration

- PPTP** Allows multiple machines on the LAN to connect to their corporate network using the PPTP protocol.
- IPSec (VPN)** Allows multiple VPN clients to connect to their corporate network using IPSec. Some VPN clients support traversal of IPSec through NAT. This Application Level Gateway (ALG) may interfere with the operation of such VPN clients. If you are having trouble connecting with your corporate network, try turning this ALG off. Please check with the system administrator of your corporate network whether your VPN client supports NAT traversal.
- RTSP** Allows applications that uses Real Time Streaming Protocol (RTSP) to receive streaming media from the Internet.
- SIP** Allows devices and applications using VoIP (Voice over IP) to communicate across NAT. Some VoIP applications and devices have the ability to discover NAT devices and work around them. This ALG may interfere with the operation of such devices. If you are having trouble making VoIP calls, try turning this ALG off.

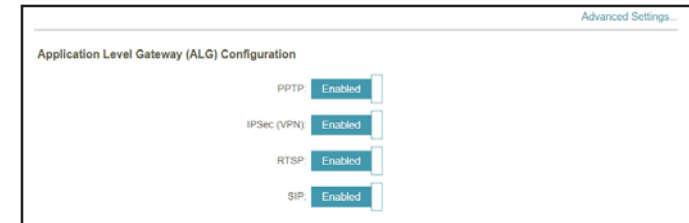

## Firewall Settings - IPv4/IPv6 Rules

In the Features menu on the bar at the top of the page, click **Firewall** to configure the router's firewall settings, then click the **IPv4 Rules** link or the **IPv6 Rules** link to configure what kind of traffic is allowed to pass through the network.

To configure the Firewall Advanced settings, click the **Advanced** link. Refer to **Firewall Settings - Advanced** on page **68**

Click **Save** at any time to save the changes you have made on this page.

To begin, use the drop-down menu to select whether you want to **ALLOW** or **DENY** the rules you create. You can also choose to turn filtering **OFF**.

If you wish to remove a rule, click on the trash can icon in the Delete column. If you wish to edit a rule, click on the pencil icon in the Edit column. If you wish to create a new rule, click the **Add Rule** button.

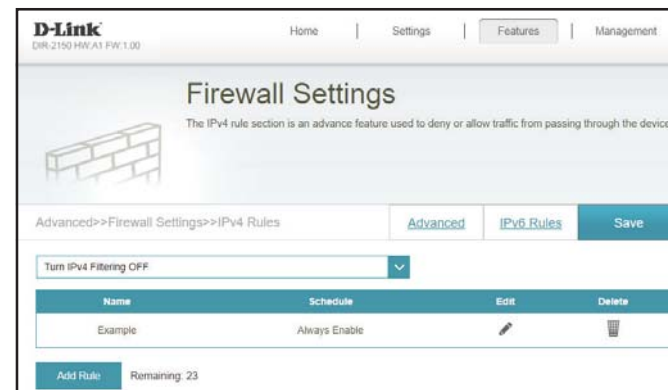

If you clicked on **Edit** or **Add Rule**, the following options will appear:

- Name** Enter a name for the rule.
- Source IP Address Range** Enter the source IP address range that the rule will apply to. Using the drop-down menu, specify whether it is a **WAN** or **LAN** IP address.
- Destination IP Address Range** Enter the destination IP address range that the rule will apply to. Using the drop-down menu, specify whether it is a **WAN** or **LAN** IP address.
- Protocol & Port Range** Select the protocol of the traffic to allow or deny (**Any, TCP, or UDP**) and then enter the range of ports that the rule will apply to.
- Schedule** Use the drop-down menu to select the time schedule that the rule will be enabled for. The schedule may be set to **Always Enable**, or you can create your own schedules in the **Schedules** section. Refer to **Time & Schedule - Schedule** on page **83** for more information.

The screenshot shows a 'Create New Rule' dialog box with the following fields and values:

- Name: [Empty text box]
- Source IP Address Range: WAN (dropdown) [Empty text box]
- Destination IP Address Range: LAN (dropdown) [Empty text box]
- Protocol & Port Range: TCP (dropdown) [Empty text box]
- Schedule: Always Enable (dropdown)
- Apply button

## Port Forwarding

In the Features menu on the bar at the top of the page, click **Port Forwarding** to specify a port or range of ports to open for specific devices on the network. This might be necessary for certain applications to connect through the router.

To configure the Virtual Server settings, click the **Virtual Server** link. Refer to **Port Forwarding - Virtual Server** on page **74**

Click **Save** at any time to save the changes you have made on this page.

If you wish to remove a rule, click on the trash can icon in the Delete column. If you wish to edit a rule, click on the pencil icon in the Edit column. If you wish to create a new rule, click the **Add Rule** button.

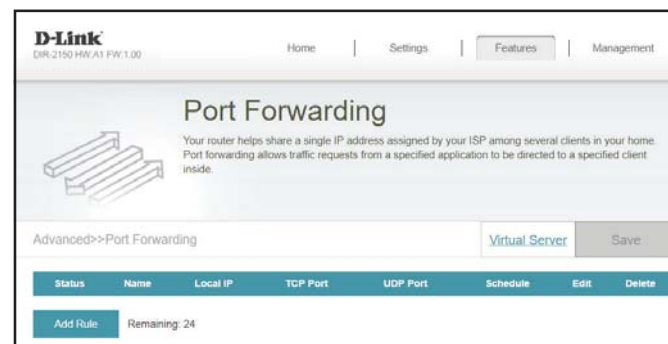

If you clicked on **Edit** or **Add Rule**, the following options will appear:

- Name** Enter a name for the rule.
- Local IP** Enter the IP address of the computer on your local network that you want to allow the incoming service to. Alternatively, select the device from the drop-down menu.
- TCP Port** Enter the TCP ports that you want to open. You can enter a single port or a range of ports. Separate ports with a comma (for example: 24,1009,3000-4000).
- UDP Port** Enter the UDP ports that you want to open. You can enter a single port or a range of ports. Separate ports with a comma (for example: 24,1009,3000-4000).
- Schedule** Use the drop-down menu to select the time schedule that the rule will be enabled for. The schedule may be set to **Always Enable**, or you can create your own schedules in the **Schedules** section. Refer to **Time & Schedule - Schedule** on page **83** for more information.

The screenshot shows a 'Create New Rule' dialog box with the following fields and options:

- Name:** A text input field.
- Local IP:** A text input field next to a drop-down menu showing '<< Computer Name'.
- TCP Port:** A text input field.
- UDP Port:** A text input field.
- Schedule:** A drop-down menu currently set to 'Always Enable'.
- Apply:** A blue button at the bottom right.

## Port Forwarding - Virtual Server

In the Features menu on the bar at the top of the page, click **Port Forwarding** then click the **Virtual Server** link to configure its settings and specify a single public port on your router for redirection to an internal LAN IP address and Private LAN port. This might be necessary for certain applications to connect through the router.

To configure the Port Forwarding settings, click the **Port Forwarding** link. Refer to **Port Forwarding** on page 72

Click **Save** at any time to save the changes you have made on this page.

If you wish to remove a rule, click on the trash can icon in the Delete column. If you wish to edit a rule, click on the pencil icon in the Edit column. If you wish to create a new rule, click the **Add Rule** button.



If you clicked on **Edit** or **Add Rule**, the following options will appear:

- Name** Enter a name for the rule. Alternatively, select the protocol/ Application Name from the drop-down menu.
- Local IP** Enter the IP address of the computer on your local network that you want to allow the incoming service to. Alternatively, select the device from the drop-down menu.
- Protocol** Select the protocol of the traffic to allow or deny (**TCP, UDP, Both, or Other**).
- Protocol Number** If you entered **Other** above, enter the protocol number.
- External Port** Enter the public port you want to open.
- Internal Port** Enter the private port you want to open.
- Schedule** Use the drop-down menu to select the time schedule that the rule will be enabled for. The schedule may be set to **Always Enable**, or you can create your own schedules in the **Schedules** section. Refer to **Time & Schedule - Schedule** on page **83** for more information.

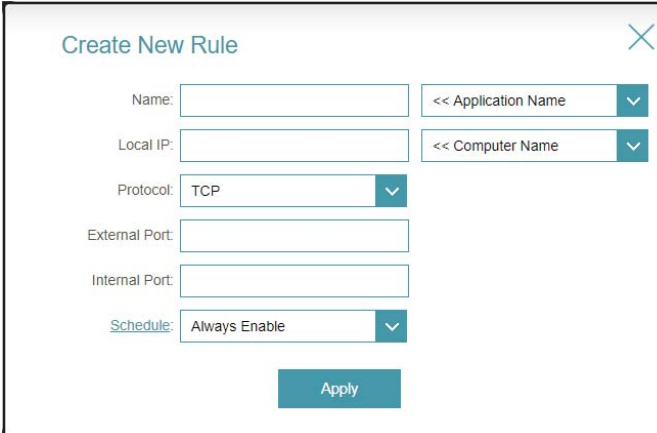

The screenshot shows a "Create New Rule" dialog box with the following fields and options:

- Name:** Text input field.
- Application Name:** Dropdown menu with "<< Application Name" selected.
- Local IP:** Text input field.
- Computer Name:** Dropdown menu with "<< Computer Name" selected.
- Protocol:** Dropdown menu with "TCP" selected.
- External Port:** Text input field.
- Internal Port:** Text input field.
- Schedule:** Dropdown menu with "Always Enable" selected.
- Apply:** Button at the bottom right.



## Website Filter

In the Features menu on the bar at the top of the page, click **Website Filter**. The website filters feature allows rules to be set that restrict access to a specified web address (URL) or blocks specified keywords in the URL. You can use Website Filter to restrict access to potentially harmful and inappropriate websites.

Click **Save** at any time to save the changes you have made on this page.

To begin, use the drop-down menu to select whether you want to **ALLOW** or **DENY** the access to the listed sites.

If you wish to remove a Website URL/Domain, click on the trash can icon in the Delete column. If you wish to list a new site to allow or deny access to, click the **Add Rule** button.

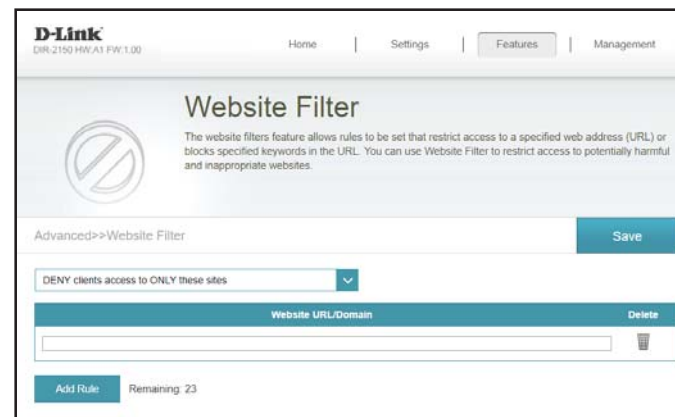

## Static Route - IPv4

In the Features menu on the bar at the top of the page, click **Static Route** to define custom routes, controlling how data traffic is moved around your network.

To configure the Static Route IPv6 settings, click the **IPv6** link. Refer to **Static Route - IPv6** on page **78**

Click **Save** at any time to save the changes you have made on this page.

If you wish to remove a route, click on the trash can icon in the Delete column. If you wish to edit a route, click on the pencil icon in the Edit column. If you wish to create a new route, click the **Add Route** button.



If you clicked on **Edit** or **Add Rule**, the following options will appear:

**Name** Enter a name for the rule.

**Destination Network** Enter the IP address of packets that will take this route.

**Mask** Enter the subnet mask of the route.

**Gateway** Enter your next hop gateway to be taken when this route is used.

**Metric** Enter a route metric value ranging from **0** to **15**. This value indicates the cost of using this route.

**Interface** Select the interface that the IP packet must use to transit out of the router when this route is used.

## Static Route - IPv6

In the Features menu on the bar at the top of the page, click **Static Route** to access the IPv4 Static Route settings, then click **IPv6** to configure the IPv6 Static Routes.

To configure the Static Route IPv4 settings, click the **IPv4** link. Refer to **Static Route - IPv4** on page 77

Click **Save** at any time to save the changes you have made on this page.

If you wish to remove a route, click on the trash can icon in the Delete column. If you wish to edit a route, click on the pencil icon in the Edit column. If you wish to create a new route, click the **Add Route** button.

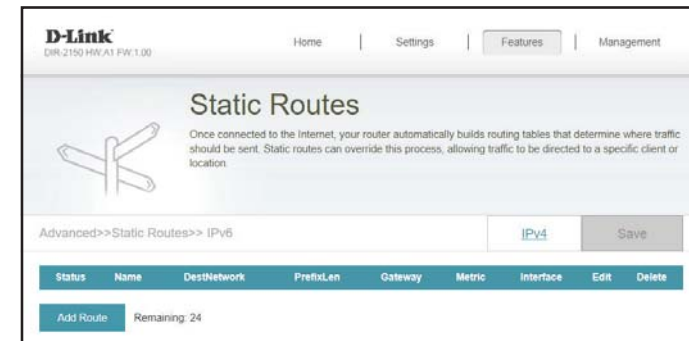

If you clicked on **Edit** or **Add Rule**, the following options will appear:

- Name** Enter a name for the rule.
- DestNetwork** This is the IP address of the router used to reach the specified destination.
- PrefixLen** Enter the IPv6 address prefix length of the packets that will take this route.
- Gateway** Enter your next hop gateway to be taken when this route is used.
- Metric** Enter a route metric value ranging from **0** to **15**. This value indicates the cost of using this route.
- Interface** Select the interface that the IP packet must use to transit out of the router when this route is used.

# Dynamic DNS

In the Features menu on the bar at the top of the page, click **Dynamic DNS**. This setting allows your router to associate an easy-to-remember domain name such as [YourDomainName].com with the regularly changing IP address assigned by your Internet Service provider. This feature is helpful when running a virtual server.

Click **Save** at any time to save the changes you have made on this page.

**Enable Dynamic DNS** Enable or disable dynamic DNS. Enabling this feature will reveal further configuration options.

**Status** Displays the current dynamic DNS connection status.

**Server Address** Enter the address of your dynamic DNS server, or select one from the drop-down menu.

**Host Name** Enter the host name that you registered with your dynamic DNS service provider.

**User Name** Enter your dynamic DNS username.

**Password** Enter your dynamic DNS password.

**Time Out** Enter a time out time (in hours).

The screenshot shows the D-Link Dynamic DNS configuration interface. At the top, there are navigation links for Home, Settings, Features, and Management. The main heading is 'Dynamic DNS' with a sub-heading explaining the service. Below this, there is a 'Save' button and a 'Dynamic DNS' status indicator set to 'Enabled'. The configuration fields include:
 

- Status: Disconnected
- Server Address: dlinkddns.com (with a dropdown menu)
- Host Name: (empty text field)
- User Name: (empty text field)
- Password: (masked with asterisks)
- Time Out: 24 hours

 At the bottom, there is a table with columns for Status, Host Name, IPv6 Address, Edit, and Delete. Below the table is an 'Add Record' button and a 'Remaining: 10' indicator.

At the bottom of the page are the IPv6 host settings.

If you wish to remove a record, click on the trash can icon in the Delete column. If you wish to edit a record, click on the pencil icon in the Edit column. If you wish to create a new record, click the **Add Record** button.

**Host Name** Enter the host name that you registered with your dynamic DNS service provider.

**IPv6 Address** Enter the IPv6 address of the dynamic DNS server. Alternatively, select the server device in the drop-down menu.



Status	Host Name	IPv6 Address	Edit	Delete
<b>Add Record</b> Remaining: 10				

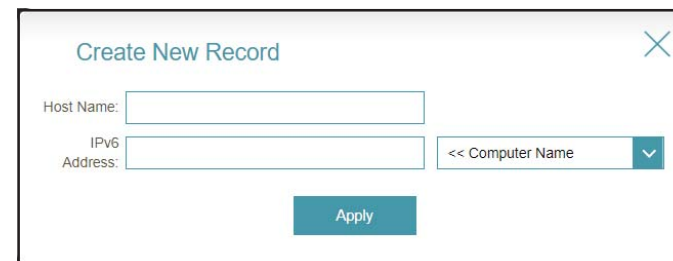

Create New Record ✕

Host Name:

IPv6 Address:  << Computer Name ▾

**Apply**

## Quick VPN

In the Features menu on the bar at the top of the page, click **Quick VPN**. This page will help you configure the Quick VPN feature of your router. For more information, refer to **Quick VPN** on page **104**. Before proceeding, ensure that your Internet connection is working properly. We recommend configuring Dynamic DNS before proceeding with Quick VPN setup. If your router is assigned an IP address from your ISP using DHCP, it may frequently change, requiring clients credentials to be set up again and a simple DDNS address will be easier than an IP address.

To configure the User settings and create, manage, and delete user accounts with user-defined access to certain router services, click the **User** link. Refer to **User** on page **88**

Click **Save** at any time to save the changes you have made on this page.

- L2TP over IPsec** Enable or disable the Quick VPN server.
- Username** Enter a username between 1 and 20 characters.
- Password** Enter a password between 1 and 20 characters.
- PSK** Enter a passkey between 6 and 64 characters.

**VPN Profile for iOS Device and MAC OS X** Click export to save the VPN profile settings file for iOS devices or Mac OS X.

### Advanced Settings...

- Authentication Protocol** Choose the authentication protocol type: **MSCHAPv2**, **PAP**, or **CHAP**. **MSCHAPv2** is the default.
- MPPE** Select the encryption cipher strength: **None**, **RC4-40**, or **RC4-128**. **RC4-128** is the default.

The screenshot displays the D-Link Quick VPN configuration interface. At the top, there are navigation links for Home, Settings, Features, and Management. The main heading is 'Quick VPN' with a sub-description: 'Quickly and easily create a profile for secure remote access to a Local Area Network (LAN). This profile can be used to configure other devices to connect to your LAN via a secure VPN tunnel.' Below this, there are two buttons: 'User' and 'Save'. The 'General' section contains a toggle for 'L2TP over IPsec' which is currently 'Enabled'. Below this are three input fields: 'Username' (vpn), 'Password' (vpn), and 'PSK' (CqgKa0263). There is an 'Export' button for the 'VPN Profile for iOS Device and Mac OS X'. A link for 'Advanced Settings...' is also present. The 'Advanced' section shows 'Authentication Protocol' set to 'MSCHAPv2' and 'MPPE' set to 'None'. The footer of the page reads 'COPYRIGHT © 2016 D-Link'.

# Management

## Time & Schedule - Time

In the Management menu on the bar at the top of the page, click **Time & Schedule**. The **Time** page allows you to configure, update, and maintain the correct time on the internal system clock. From here you can set the time zone and the Network Time Protocol (NTP) server.

To configure the Schedule settings, click the **Schedule** link. Refer to **Time & Schedule - Schedule** on page **83**

Click **Save** at any time to save the changes you have made on this page.

### Time Configuration

**Time Zone** Select your time zone from the drop-down menu.

**Time** Displays the current date and time of the router.

### Automatic Time Configuration

**NTP Server** Select from the drop-down menu to either use the D-Link NTP Server to synchronize the time and date for your router, or choose Manual to set the NTP server's IP address.

## Time & Schedule - Schedule

In the Management menu on the bar at the top of the page, click **Time & Schedule** to access the Time page, then click the **Schedule** link. The **Schedule** page allows you to control some of the router functions through a pre-configured schedule.

To configure the Time settings, click the **Time** link. Refer to **Time & Schedule - Time** on page **82**

Click **Save** at any time to save the changes you have made on this page.

If you wish to remove a schedule, click on the trash can icon in the Delete column. If you wish to edit a schedule, click on the pencil icon in the Edit column. If you wish to create a new schedule, click the **Add a Schedule** button.

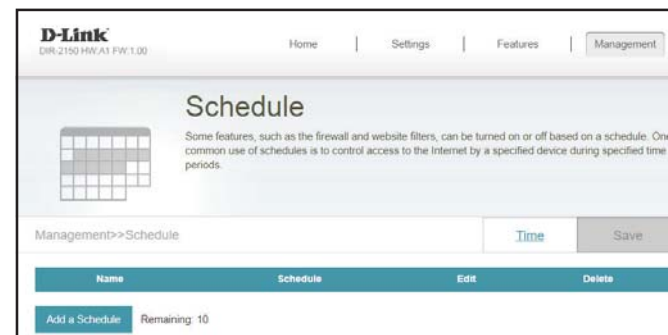

First, enter the name of your schedule in the **Name** field.

Each box represents one hour, with the time at the top of each column. To add a time period to the schedule, simply click on the starting hour and drag to the ending hour. You can add multiple days to the schedule, but only one period per day.

To remove a time period from the schedule, click on the cross icon.

Click **Apply** when you are done.

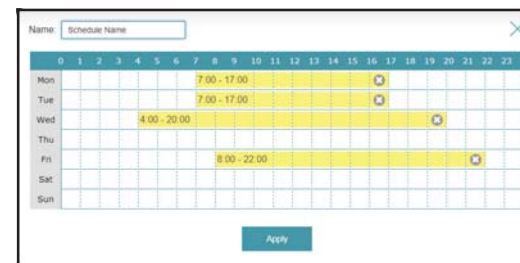
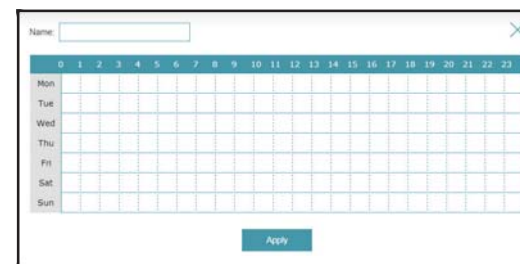



# System Log

In the Management menu on the bar at the top of the page, click **System Log**. The router keeps a running log of events. This log can be sent to a Syslog server, or sent to your email address.

Click **Save** at any time to save the changes you have made on this page.

## Log Settings

### System Log

Click the **Check System Log** button to download a text file containing the system log.

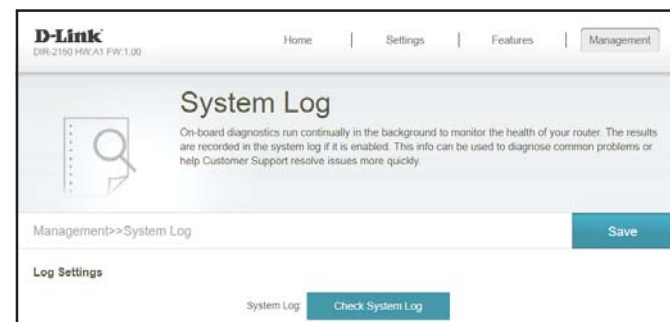

## SysLog Settings

### Enable Logging to Syslog Server

Check this box to send the router logs to a SysLog Server.

### SysLog Server IP Address

Configurable if **Enable Logging to Syslog Server** is enabled. Enter the IP address for the Syslog server. If the Syslog server is connected to the router, select it from the drop-down menu to automatically populate the field.

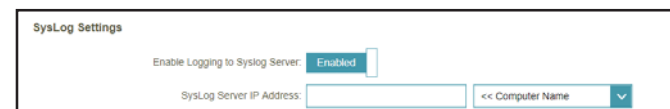

## Email Settings

**Enable E-mail Notification** Enable this option if you want the logs to be automatically sent to an email address.

*If you enabled **Enable E-mail Notification**, the following options will appear:*

**From E-mail Address** Enter the email address your SysLog messages will be sent from.

**To E-mail Address** Enter the email address your SysLog messages will be sent to.

**SMTP Server Address** Enter your SMTP server address.

**SMTP Server Port** Enter your SMTP server port.

**Enable Authentication** Check this box if your SMTP server requires authentication.

**Account Name** Enter your SMTP account name.

**Password** Enter your SMTP account's password.

## E-mail Log When Full or On Schedule

**Send When Log Full** If enabled, this option will set the router to send the log when it is full.

**Send on Schedule** If enabled, this option will set the router to send according to a set schedule.

**Schedule** If you enable Send On Schedule, use the drop-down menu to select a schedule to apply. The schedule may be set to Always Enable, or you can create your own schedules in the Schedules section. Refer to **Time & Schedule - Schedule** on page **83** for more information.