

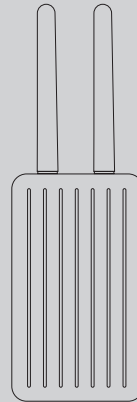

## Quick Installation Guide

Wireless AC1200 Wave 2 Industrial  
Outdoor Access Point

DIS-3650AP



Additional documentation is also available on the D-Link website

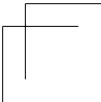
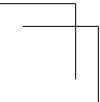
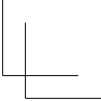
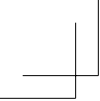

## Before You Begin

This installation guide provides instructions for installing the DIS-3650AP on your network. Additional documentation is also available on the D-Link support website.

- **Nuclias Connect Manual:** For additional information and instructions on how to configure the device using Nuclias Connect.
- **DIS-3650AP User Manual:** For additional information and instructions on how to configure the device using the web user interface.

## Package Contents

This DIS-3650AP package includes the following items:

- DIS-3650AP Access Point
- Quick Start Guide
- Mounting kit (Wall/Pole/DIN Rail Mount)
  - Articulation Pole x 1
  - T-form Bracket x 1
  - M8x40 Screw Bolts x 1
  - M6 Screw x 4
  - M8 Nut x 1
  - Washer (M8 x 1 ; M6 x 4)
  - Spring Washer (M8 x 1 ; M6 x 4)
  - Stainless Hose Clamp x 2
  - Anchors plastic screws x 4
  - Stainless screws x 4
  - DIN Rail mounting kit

If any of the above items are damaged or missing, please contact your local D-Link reseller.

**Note:** To power the unit, use an 802.3at PoE Switch or PoE Injector.

## System Requirements

- Computers with Windows®, Macintosh®, or Linux-based operating systems with an installed Ethernet Adapter

## Hardware Overview

### LED Indicators

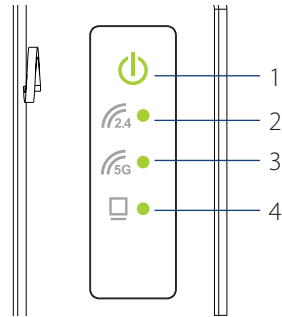

Figure 1: Side Panel LED

#	LED	Description
1	Power/Status	<b>Green (Solid)</b> - Device operational <b>Red (Flashing)</b> - Device booting up/ Device malfunctioned <b>Red (Solid)</b> - Device boot up has failed
2	2.4	<b>Solid green</b> - 2.4GHz is enabled <b>Blinking green</b> - data transmission
3	5G	<b>Solid green</b> - 5GHz is enabled <b>Blinking green</b> - data transmission
4	LAN (PoE)	Indicates whether a device is connected to LAN and receiving power on the PoE port.

Table 1: LED Description

## Interface Connectors

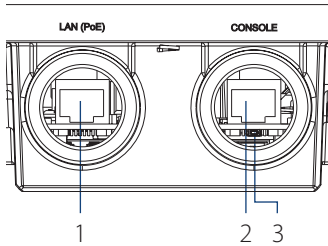

Figure 2: Top Connectors

#	Connector	Description
1	LAN(PoE)	Gigabit RJ-45 port for data and Power over Ethernet (PoE) power.
2	CONSOLE	Connect an RJ-45 Ethernet console for CLI control (Option)
3	Reset	Press and hold for 10 seconds to factory reset the device

Table 2: Interface Description

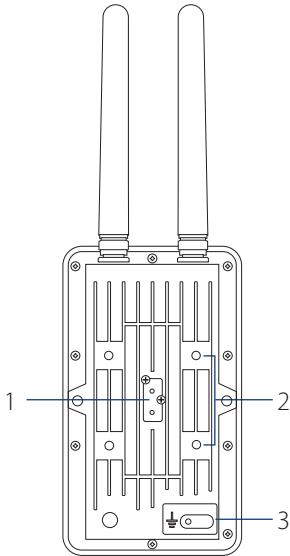

Figure 3: Back Connectors

#	Connector	Description
1	DIN rail Adapter	Connect DIN rail kit to mount it on DIN-Rail.
2	Wall/Pole Mount	Mount to connect to the mounting plate on a wall or a pole.
3	Grounding Wire	Connector for the grounding wire.

Table 3: Interface Description

## Installation

### Using Power over Ethernet (PoE)

1. Use a standard Ethernet cable to connect the LAN(PoE) port on the DIS-3650AP to a PoE power source device such as an 802.3at PoE switch or PoE injector.

## Configuration

### Using Nuclias Connect

The DIS-3650AP is designed to be managed through Nuclias Connect. Refer to the **Nuclias Connect Manual** for detailed configuration instructions.

**Note:** D-Link recommends manually configuring the device before mounting it.

### Nuclias Connect App Configuration

1. Download the free Nuclias Connect app from the App Store or Google Play by searching for **Nuclias Connect** or by scanning the QR code below.



- Open the Nuclias Connect app and follow the onscreen instructions to discover and set up your device.

## Manual Configuration

**Note:** The management computer, DHCP server and DIS-3650AP must be in the same subnet.

Use one of the following methods to access the web user interface:

### Connecting through Ethernet

- Use an Ethernet cable to connect the DIS-3650AP to the switch or router the management computer is connected to.
- Manage the access point from a computer. Enter **dis3650ap.local** in the address field of your browser.
- Log in to the administration user interface. The default login information is

Username: **admin**  
Password: **admin**

### Connecting Wirelessly

- Connect the management computer to the default SSID of the DIS-3650AP, "**dlink**".
- Manage the access point from a computer. Enter **dis3650ap.local** in the address field of your browser.
- Log in to the administration user interface. The default login information is

Username: **admin**  
Password: **admin**

## Mounting

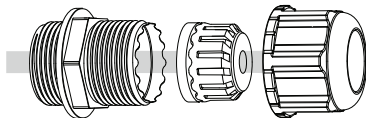

Figure 4: LAN Port Waterproof Enclosure

Connect an Ethernet Cable to the LAN(PoE) port on the DIS-3650AP. Use the LAN Port Waterproof Enclosures to seal the ports.

## Install Enclosure Onto The Articulation Pole

Attach the articulation pole to back of AC using M5x16 screws & washers.

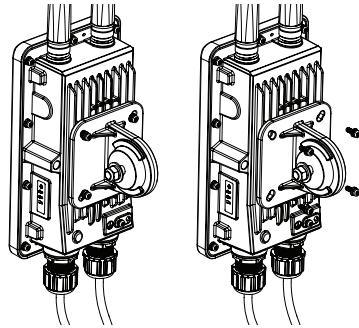

Figure 5

## Installation for Wall

Fix the T-from Bracket to the wall by using the wood / gyprock screws.

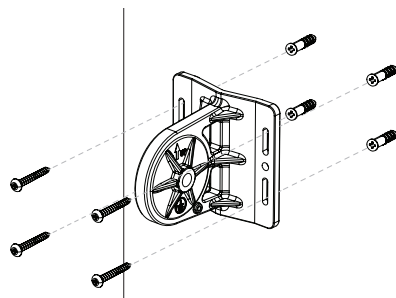

Figure 6

### Installation for Pole

Mounting for Recommended Pole Dia.:  
1.5~2"(38.1~50.8mm)

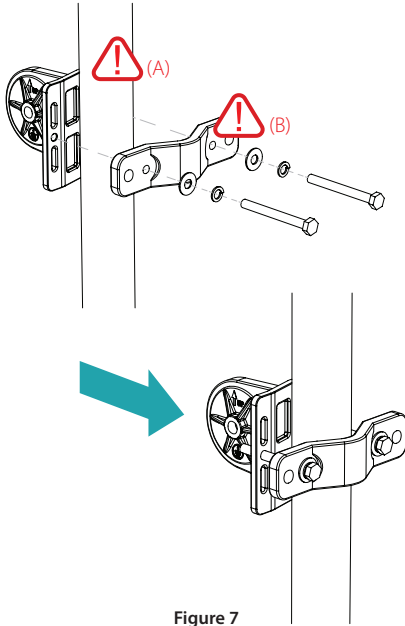

Figure 7

(A) The diameter of the Pole is too large Will result in the failure to install smoothly, the diameter is too small and the clamping force is insufficient.

\* Pole diameter Max.: 2.1"(53.3mm)  
Min.: 1.0"(25.4mm)

(B) To minimize bolts crosstalk, the bolts should gradually increasing load and parallel tighten.

### Mounting for Pole 1~3" (25.4~76.2mm)

Fix the T-from Bracket to the pole by using the stainless hose clamp.

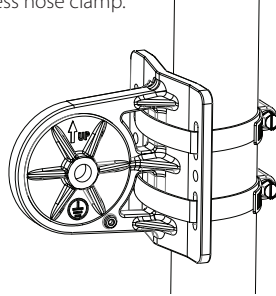

Figure 8

### Install Articulation Pole with The T-formed Bracket

After finishing the previous two steps, fix the articulation pole to the T-formed bracket by using M8x40 bolts, nut, spring washer and washer.

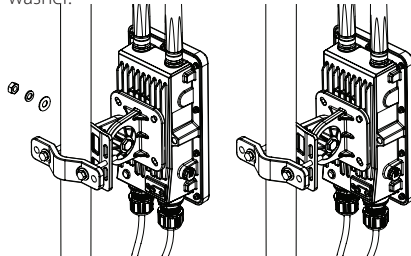

Figure 9

## Installation for DIN Rail

The DIS-3650AP can be mounted on a standard DIN rail using the included DIN mounting kit. Use the following instructions to install the DIS-3650AP on a rail:

1. Install a Din rail kit on enclosure. Check that the DIN rail kit is installed properly using two screws on each end.

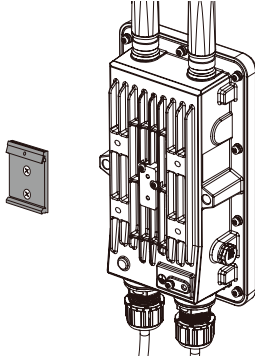

Figure 10

2. Position the DIS-3650AP against the rail, then tilt it upwards and hook the DIN rail clip on the back of the device against the rail. Snap the device into place to complete the installation.

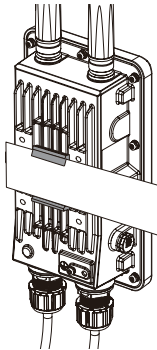

Figure 11

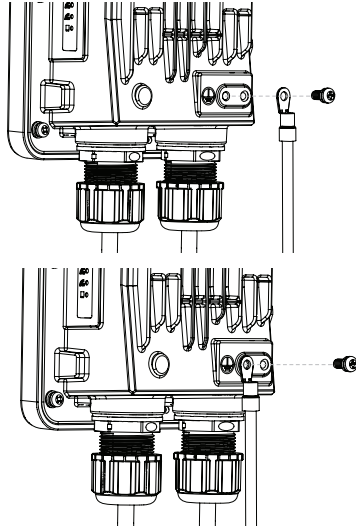

Figure 12: Attaching the Grounding Wire

3. A grounding wire is to protect your device from lightning strikes and the buildup of static electricity. Attach the grounding wire to the DIS-3650AP using the included screw (M3.9 \* 7.8 mm).

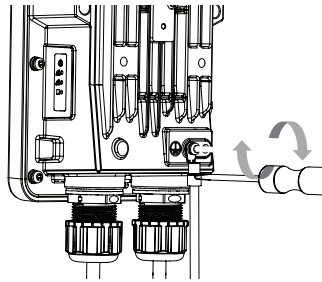
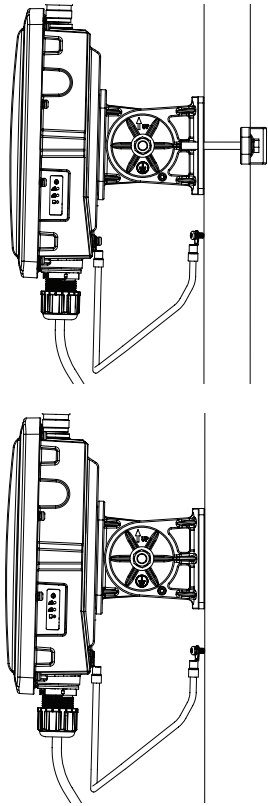

Figure 13: Attaching the Grounding Wire

4. Tighten the grounding wire (green-and-yellow, 18AWG) to the DIS-3650AP until it is securely attached.



**Figure 14: Attaching the Grounding Wire**

5. Attach the other end of the grounding wire to either the wall or pole mount. Ensure that the wall or pole mount is connected to an electrical ground.

## Professional installation instruction

### 1. Installation personal

This product is designed for specific application and needs to be installed by a qualified personal who has RF and related rule knowledge. The general user shall not attempt to install or change the setting.

### 2. Installation location

The product shall be installed at a location where the radiating antenna can be kept 28cm from nearby person in normal operation condition to meet regulatory RF exposure requirement.

### 3. External antenna

Use only the antennas which have been approved by the applicant. The non-approved antenna(s) may produce unwanted spurious or excessive RF transmitting power which may lead to the violation of FCC limit and is prohibited.

### 4. Installation procedure

Please refer to user's manual for the detail.

### 5. Warning

Please carefully select the installation position and make sure that the final output power does not exceed the limit set force in relevant rules. The violation of the rule could lead to serious federal penalty.



# Appendix - Statements

## Federal Communication Commission Interference Statement

This device complies with Part 15 of the FCC Rules. Operation is subject to the following two conditions: (1) This device may not cause harmful interference, and (2) this device must accept any interference received, including interference that may cause undesired operation.

**NOTE:** This equipment has been tested and found to comply with the limits for a Class A digital device, pursuant to part 15 of the FCC Rules. These limits are designed to provide reasonable protection against harmful interference when the equipment is operated in a commercial environment. This equipment generates, uses, and can radiate radiofrequency energy and, if not installed and used in accordance with the instruction manual, may cause harmful interference to radio communications. Operation of this equipment in a residential area is likely to cause harmful interference in which case the user will be required to correct the interference at his own expense.

## FCC Caution:

- Any changes or modifications not expressly approved by the party responsible for compliance could void the user's authority to operate this equipment.
- This transmitter must not be co-located or operating in conjunction with any other antenna or transmitter.

## Radiation Exposure Statement:

This equipment complies with FCC radiation exposure limits set forth for an uncontrolled environment. This equipment should be installed and operated with minimum distance 28cm between the radiator & your body.

**Note:** The country code selection is for non-US model only and is not available to all US model. Per FCC regulation, all WiFi product marketed in US must be fixed to US operation channels only.

## Déclaration d'exposition aux radiations

Cet équipement est conforme aux limites d'exposition aux rayonnements ISSED établies pour un environnement non contrôlé. Cet équipement doit être installé et utilisé avec un minimum de 0.28 m de distance entre la source de rayonnement et votre corps.

## RED Compliance Statement

Compliance with 2014/53/EU Radio Equipment Directive (RED)

In accordance with Article 10.8(a) and 10.8(b) of the RED, the following table provides information on the frequency bands used and the maximum RF transmit power of the product for sale in the EU:

Frequency range (MHz)	Max. transmit power (dBm)
2412-2472	19.88 dBm
5500-5700	28.44 dBm

This equipment should be installed and operated with a minimum distance of 20 centimeters between the radiator and your body.

## Product and Warranty Information

To find out more about D-Link Nuclias product or marketing information, please visit the website <http://www.dlink.com> or <https://www.nuclias.com>.

The D-Link Limited Lifetime Warranty information is available at <http://www.dlink.com/warranty>

1. Instructions for the installation of that conductor to building earth by a SKILLED PERSON.
2. Please contact the authorized distributor of D-Link for related accessories (Outdoor interconnection cable, Cable Gland, Cable, etc.) for purchase and installation.

# Notes

# Notes

# Notes

# Notes

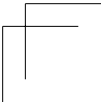
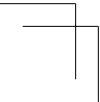
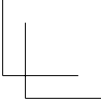
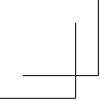

**D-Link**<sup>®</sup>  
Building Networks for People



Ver. 1.00(WW)\_130x183  
2021/09/27  
5300-00008121-01W