

USER'S GUIDE

COLOR MONITOR

Model No : 531X



IMPORTANT SAFEGUARDS

1. Read all of these instructions.

2. Save these instructions for later use.



3. Unplug this monitor from the wall outlet before cleaning. Do not use liquid cleaners or aerosol cleaners. Use a damp cloth for cleaning.

4. Do not use attachments not recommended by the monitor manufacturer as they may cause hazards.

5. Do not use this monitor near water, e.g., near a bathtub, washbowl, kitchen sink, or laundry tub, in a wet basement, or near a swimming pool, etc.



6. Do not place this monitor on an unstable cart, stand, or table. The monitor may fall, causing serious injury to a child or adult, and serious damage to the appliance.



7. Slots and openings in the cabinet and the back or bottom are provided for ventilation, to ensure reliable operation of the monitor, and to protect it from overheating.

These openings must not be blocked or covered. The openings should never be blocked by placing the monitor on a bed, sofa, rug, or other similar surface. This monitor should never be placed near or over a radiator or heat register. This monitor should not be placed in a built-in installation such as a bookcase unless proper ventilation is provided.



8. This monitor should be operated only from the type of power source indicated on the marking label. If you are not sure of the power supplied to your home, consult your monitor dealer or local power company.



9. This monitor is equipped with a 3-wire grounding-type plug. That is, a plug having a third (grounding) pin. This plug will only fit into a grounding-type power outlet. This is a safety feature. If you are unable to insert the plug into the outlet, contact your electrician to replace your obsolete outlet. Do not defeat the purpose of the grounding-type plug.



10. Do not allow anything to rest on the power cord. Do not locate this monitor where the cord will be abused by people walking on it.

11. Follow all warnings and instructions marked on the monitor.



12. For added protection for this monitor during a lightning storm, or when it is left unattended and unused for long periods of time, unplug it from the wall outlet. This will prevent damage to the monitor and/or the computer due to lightning and power line surges.

13. Do not overload wall outlets and extension cords as this can result in fire or electric shock.

14. Never push objects of any kind into this monitor through cabinet slots, as they may touch dangerous voltage points or short out parts that could result in a fire or electric shock. Never spill liquid of any kind on the monitor.



15. Do not attempt to service this monitor yourself, as opening or removing covers may expose you to dangerous voltages or other hazards. Refer all servicing to qualified service personnel.

16. Unplug this monitor from the wall outlet and refer servicing to qualified service personnel under the following conditions:

a. When the power cord or plug is damaged or frayed.

b. If liquid has been spilled into the monitor.

c. If the monitor has been exposed to rain or water.

d. If the monitor does not operate normally by following the operating instructions. Adjust only those controls that are covered by the operating instructions, as improper adjustment of other controls may result in damage and will often require extensive work by a qualified technician to restore normal operation.

e. If the monitor has been dropped or the cabinet has been damaged.

f. When the monitor exhibits a distinct change in performance, this indicates a need for service.



17. When replacement parts are required be sure the service technician has used replacement parts specified by the manufacturer that have the same characteristics as the original part. Unauthorized substitutions may result in fire, electric shock, or other hazards.

18. Upon completion of any service or repairs to this monitor, ask the service technician to perform routine safety checks to determine that the monitor is safe to operate.

FEDERAL COMMUNICATIONS COMMISSION RADIO FREQUENCY INTERFERENCE STATEMENT

NOTE : This equipment has been tested and found to comply with the limits for a Class B digital device, pursuant to Part 15 of the FCC Rules. These limits are designed to provide reasonable protection against harmful interference in a residential installation. This equipment generates, uses and can radiate radio frequency energy and, if not installed and used in accordance with the instructions, may cause harmful interference to radio communications. However, there is no guarantee that interference will not occur in a particular installation. If this equipment does cause harmful interference to radio or television reception, which can be determined by turning the equipment off and on, the user is encouraged to try to correct the interference by one or more of the following measures :

- Reorient or relocate the receiving antenna.
- Increase the separation between the equipment and receiver.
- Connect the equipment to an outlet on a circuit different from that to which the receiver is connected.
- Consult the dealer or an experienced radio or TV technician for help.

CAUTION : Any changes or modifications not expressly approved by the party responsible for compliance could void the user's authority to operate the equipment.

CANADIAN NOTICE

This Class B digital apparatus meets all requirements of the Canadian Interference-Causing Equipment Regulations.

AVIS CANADIEN

Cet appareil numérique de la Class B respecte toutes les exigences du Règlement sur le matériel brouilleur du Canada.

WICHTIGE INFORMATIONEN

Bitte lesen Sie alle diese Informationen, bevor Sie das Gerät in Betrieb nehmen! Lesen Sie sich außerdem die Bedienungsanleitung komplett und sorgfältig durch, da nur in diesem Fall eine problemlose Inbetriebnahme erwartet werden kann.

- Achten Sie darauf, daß das Gerät nur in eine 230V Schuko-Steckdose eingesteckt wird.
- Die Steckdose sollte jederzeit frei zugänglich sein um bei einem evtl. auftretenden Notfall das Gerät schnell vom Netz zu trennen.
- Achten Sie desweiteren darauf, daß die Netzanschlußleitung nicht mechanisch beansprucht oder sonstwie beschädigt wird.
- Öffnen Sie das Gerät niemals! Im Inneren befinden sich Teile mit gefährlicher Spannung.
- Bevor Sie das Gerät reinigen, ziehen Sie bitte den Netzstecker aus der Steckdose. Säubern Sie dann das Gerät mit einem feuchten (keinesfalls tropfnassen) Lappen.
- Die in diesem Gerät entstehende Röntgenstrahlung ist ausreichend abgeschirmt (Ortsdosisleistung in 0.1m Abstand weniger als 1.0µ Sv/h). Beschleunigungsspannung maximal 26kV.
- Stellen Sie das Gerät an einem ergonomisch günstigen Ort auf und sorgen Sie dafür, daß der Monitor mit nach ISO 9241 -3, -7, -8 geprüfter Peripherie betrieben wird, da nur unter diesen Umständen ein optimaler ergonomischer Betrieb des Gerätes sichergestellt ist.

Falls Sie dennoch Fragen haben, auf die die Bedienungsanleitung keine hinreichende Antwort geben kann, so kontaktieren Sie bitte den nächsten Fachhändler.

Maschinenlärminformationsverordnung 3. GSGV, 18.01 1991:
Der arbeitsplatzbezogene Schalldruckpegel beträgt 70 dB (A) oder weniger gemäß ISO 7779.

European Union Notice

Products with the CE Marking comply with both the EMC Directive (89/336/EEC) and the the Low Voltage Directive (73/23/EEC) issued by the Commission of the European Community.

Compliance with these directives implies conformity to the following European Norms (in brackets are the equivalent international standards):

- EN55022 (CISPR 22) - Electromagnetic Interference
- EN55024 - Immunity Test for ITE Product
- EN60950 (IEC950) - Product Safety
- EN61000-3-2 (IEC555-2) - Power Line Harmonics

Emission Characteristics Tested by SEMKO

A sample of this type has been tested and has shown compliance with the guidelines in the swedish document MPR II.

This product is also designed for IT power system with phase to phase voltage of 230V.

The power cord is used as a main disconnect device. Disconnect the power cord before servicing. The outlet must be installed near the monitor and must be easily accessible.

As an ENERGY STAR® Partner, Daewoo Lucoms Co., Ltd. has determined that this product meets the Energy Star® guidelines for energy efficiency.

The appliance is not intended for use by young children or infirm persons without supervision ;
Young children should be supervised to ensure that they do not play with the appliance.

CONTENTS

Introduction	1
Product Features	2
Setup	3
Installing the Tilt/Swivel Stand	3
Connecting the Signal Cable and Power Cord.....	4
Operation & Adjustment	5
Specifications	9
Factory Preset Timings	9
Troubleshooting	10

INTRODUCTION

This manual explains how to correctly install, operate, and get the best performance from your monitor. Please read this user's guide carefully before installing your monitor, then keep it near your monitor for quick reference.

First, please check that the contents of the box corresponds with the following checklist :

- Color monitor
- Power cord
- User's Guide
- Tilt/swivel stand
- Warranty Card (Optional)

If any item is missing or damaged, please contact your dealer. Please keep the box and packing materials so that you may properly store or transport your monitor.

PRODUCT FEATURES

- The convenient and user-friendly on-screen display allows for easy and accurate adjustments of horizontal and vertical screen size and position, geometry, and screen color.
- The monitor supports a safe working environment in strict compliance with the MPR II standard for low emissions.
- The monitor complies with the VESA Display Data Channel (DDC) specification for Plug and Play compatibility. Advanced microcircuitry makes setup and configuration fast and effortless.
- The monitor features Advanced Color Controls for fine-tuning to meet your own personal tastes or application requirements. Use the on-screen controls to adjust the color temperature, RGB gain value for the best possible screen color and intensity.
- Press the menu button and activate the Self-Diagnosis menu to determine whether your monitor is functioning normally, not receiving a signal or is receiving a signal that is out of scanning range.
- Activate the higher refresh rates of the monitor to stabilize the screen and eliminate the annoying flicker that contributes to eye-strain and headaches.
- The “borderless” full-screen display capability works under all graphic modes and provides a larger viewing area than conventional monitors, giving you a better picture with more workspace.
- With the POWER LIGHT function added, you can enjoy the bright screen for movie or any other multimedia utilization.

SETUP

INSTALLING THE TILT/SWIVEL STAND

1. Ensure that the power is off to the monitor.
2. Set the monitor face down with the underside facing you. Please be careful not to scratch the monitor screen.
3. Align the hooks on the stand with the guide holes on the bottom chassis of the monitor.
4. Insert the hooks into the guide holes.
5. Slide the tilt/swivel stand toward the front of the monitor until the latch locks in position.
6. Turn the monitor and the stand upright.

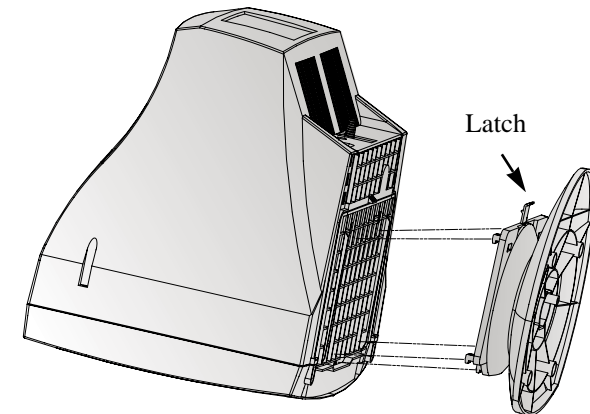

If you want to remove the tilt/swivel stand on the monitor, press the latch and pull the tilt/swivel stand toward the back of the monitor. Lift the stand to separate.

CONNECTING THE SIGNAL CABLE AND POWER CORD

1. Turn off the computer and monitor.
2. Connect the 15 pin D-sub connector to the output port of the video card in your computer.
3. Tighten the screws of the connector.
4. Plug the power cord into the AC receptacle located on the back of the monitor.
5. Plug the other end of the power cord into the AC outlet.

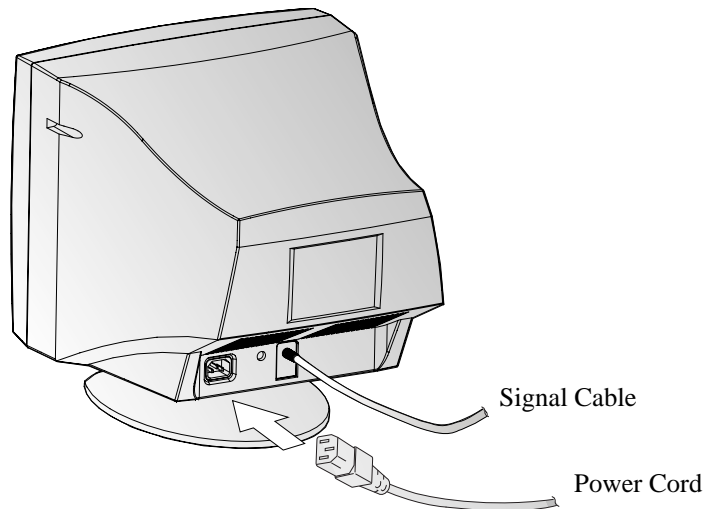

If your power cord is PC-to-Monitor type, plug the other end of the power cord into the AC receptacle in the computer.

OPERATION & ADJUSTMENT

Control Panel

▼ BRIGHTNESS ▲ MENU ◀ CONTRAST ▶



POWER LIGHT

- ▶
POWER LIGHT
 - Increase the value of any selected function.
 - While the OSD screen is off, you can adjust the screen brightness according to each situation.
- ◀
POWER LIGHT
 - Decrease the value of any selected function.
- MENU
 - Turns the OSD window on and off.
- ▲
POWER LIGHT
 - Move cursor to the previous function on the OSD window.
- ▼
POWER LIGHT
 - Move cursor to the next function on the OSD window.

Hot Key

▲ BRIGHTNESS ▼

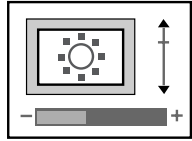

When there is no OSD, if you press this BRIGHTNESS button, you can adjust the brightness directly.

◀ CONTRAST

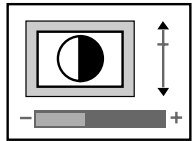



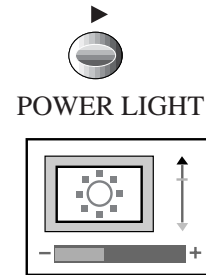

When there is no OSD, if you press this CONTRAST button, you can adjust the contrast directly.



The screen will be bright progressively by 10% (PC/GAME/MOVIE Mode).
If you carry out general PC works such as document edition on the Movie mode, you may shorten the life span of CRT. Thus, it is recommended to verify the selected mode before use.

OSD Functions

ICON	CONTROL	FUNCTION
	PINCUSHION	Adjust the left and right margins for more convex or more concave margins.
	TRAPEZOID	Adjust the trapezoid of the screen by moving the lines inward or outward.
	PIN BALANCE	Adjust the side balance when the sides of the screen are bowed towards left or right.
	PARALLELOGRAM	Adjust the parallelogram when the screen is leaning left or right.
	COLOR TEMP	Choose different preset color temperatures or set your own customized color parameters.(5000K is user mode)
	RED GAIN	Adjust the red gain.
	GREEN GAIN	Adjust the green gain.
	BLUE GAIN	Adjust the blue gain.
	DEGAUSS	Degaussing keeps the monitor free from unwanted magnetism that can result in color impurity.
	H. MOIRE	Adjust the horizontal picture moire cancellation.
	V. MOIRE	Adjust the vertical picture moire cancellation.
	RESET	Reset the screen to the Factory Preset Display Settings.

ICON	CONTROL	FUNCTION
	H. CENTER	Adjust the position of the display horizontally (left or right) .
	V. CENTER	Adjust the position of the display vertically (up or down).
	H. SIZE	Adjust the width (horizontal size) of the display.
	V. SIZE	Adjust the height (vertical size) of the display.

Self Diagnosis

When the monitor doesn't display, if you press any key, Self Diagnosis screen is displayed. Self Diagnosis function checks if the status of the monitor is No Signal or Out of range.

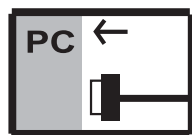

No Signal screen is displayed when the D-Sub signal connector is not connected or the status of the monitor is on DPMS mode.

Out of Range screen is displayed when the applied frequency is under or over normal range.

- Normal range
- H : 30 - 54 KHz
- V : 50 - 160 Hz

SPECIFICATIONS

CDT Size		15-inch
Diagonal visible image area		14-inch
Dot Pitch		0.28 mm
Synchronization	Horizontal	30 - 54 KHz
	Vertical	50 - 160 Hz
Plug and Play		VESA DDC Compatible
Power Saving		EPA, VESA DPMS, Nutek Compliant
Power Source		100-240 Vac, 50/60Hz (Free Voltage)
Power Consumption		70 W
Dimension-W x H x D (set with stand)		360 x 377 x 389 mm
Weight-unpacked (lbs/Kg)		25.4/11.5
Operating Temperature		10 ~ 40°C / 50 ~ 104°F

* This specification can be changed without any prior notice to improve the quality of the product.

FACTORY PRESET TIMINGS

Mode	Resolution (dots X lines)	H.Freq(KHz)	V.Freq(Hz)	Remark
VGA	640 X 480	31.5	60	Non-interlaced
VESA VGA 75	640 X 480	37.5	75	Non-interlaced
VGA	720 X 400	31.5	70	Non-interlaced
VESA SVGA 60	800 X 600	37.9	60	Non-interlaced
VESA 46K	800 X 600	46.9	75	Non-interlaced
VESA SVGA 85	800 X 600	53.7	85	Non-interlaced
VESA 48K	1024 X 768	48.3	60	Non-interlaced

TROUBLESHOOTING

Symptom	Check
No picture.	Check if power switch and computer power switch are in the on position.
	↓
	Check if the signal cable is correctly connected to the video card.
	↓
	Check if the pins of D subconnector are not bent.
	↓
	Check if the computer is in the power- saving mode.
POWER LED is not lit.	Check if power switch is in the on position.
	↓
	Check if the power cord is correctly connected.
Image is unstable.	Check if the signal cable is suitable to the video card.
Image is not centered, too small or too large.	Adjust H&V Size or H&V Center to get the proper image.
Picture bounces or a wave pattern is present in the picture.	Keep the devices that may cause electrical interference away from the monitor.
	↓
	See the FCC information at the front cover of the manual.
Color looks blotchy.	Operate Degauss once.
Picture is blurred.	Adjust Contrast and Brightness.
	↓
	Operate Degauss once.
Edges of available area on the screen are not straight.	Adjust Geometry Control (Pincushion, Trapezoid..).