



**DAEWOO**

# **USER'S GUIDE**

TFT-LCD MONITOR

Model No : L950 / L750

## IMPORTANT SAFEGUARDS

1. Read all of these instructions.

2. Save these instructions for later use.



3. Unplug this monitor from the wall outlet before cleaning. Do not use liquid cleaners or aerosol cleaners. Use a damp cloth for cleaning.

4. Do not use attachments not recommended by the monitor manufacturer as they may cause hazards.

5. Do not use this monitor near water, e.g., near a bathtub, washbowl, kitchen sink, or laundry tub, in a wet basement, or near a swimming pool, etc.



6. Do not place this monitor on an unstable cart, stand, or table. The monitor may fall, causing serious injury to a child or adult, and serious damage to the appliance.



7. Slots and openings in the cabinet and the back or bottom are provided for ventilation, to ensure reliable operation of the monitor, and to protect it from overheating.

These openings must not be blocked or covered. The openings should never be blocked by placing the monitor on a bed, sofa, rug, or other similar surface. This monitor should never be placed near or over a radiator or heat register. This monitor should not be placed in a built-in installation such as a bookcase unless proper ventilation is provided.



8. This monitor should be operated only from the type of power source indicated on the marking label. If you are not sure of the power supplied to your home, consult

your monitor dealer or local power company.



9. This monitor is equipped with a 3-wire grounding-type plug. That is, a plug having a third (grounding) pin. This plug will only fit into a grounding-type power outlet. This is a safety feature. If you are unable to insert the plug into the outlet, contact your electrician to replace your obsolete outlet. Do not defeat the purpose of the grounding-type plug.



10. Do not allow anything to rest on the power cord. Do not locate this monitor where the cord will be abused by people walking on it.

11. Follow all warnings and instructions marked on the monitor.



12. For added protection for this monitor during a lightning storm, or when it is left unattended and unused for long periods of time, unplug it from the wall outlet. This will prevent damage to the monitor and/or the computer due to lightning and power line surges.

13. Do not overload wall outlets and extension cords as this can result in fire or electric shock.

14. Never push objects of any kind into this monitor through cabinet slots, as they may touch dangerous voltage points or short out parts that could result in a fire or electric shock. Never spill liquid of any kind on the monitor.



15. Do not attempt to service this monitor yourself, as opening or removing covers may expose you to dangerous voltages or other hazards. Refer all servicing to qualified service personnel.

16. Unplug this monitor from the wall outlet and refer servicing to qualified service personnel under the following conditions:

a. When the power cord or plug is damaged or frayed.

b. If liquid has been spilled into the monitor.

c. If the monitor has been exposed to rain or water.

d. If the monitor does not operate normally by following the operating instructions. Adjust only those controls that are covered by the operating instructions, as improper adjustment of other controls may result in damage and will often require extensive work by a qualified technician to restore normal operation.

e. If the monitor has been dropped or the cabinet has been damaged.

f. When the monitor exhibits a distinct change in performance, this indicates a need for service.



17. When replacement parts are required be sure the service technician has used replacement parts specified by the manufacturer that have the same characteristics as the original part. Unauthorized substitutions may result in fire, electric shock, or other hazards.

18. Upon completion of any service or repairs to this monitor, ask the service technician to perform routine safety checks to determine that the monitor is safe to operate.



## FEDERAL COMMUNICATIONS COMMISSION RADIO FREQUENCY INTERFERENCE STATEMENT

**NOTE :** This equipment has been tested and found to comply with the limits for a Class B digital device, pursuant to Part 15 of the FCC Rules. These limits are designed to provide reasonable protection against harmful interference in a residential installation. This equipment generates, uses and can radiate radio frequency energy and, if not installed and used in accordance with the instructions, may cause harmful interference to radio communications. However, there is no guarantee that interference will not occur in a particular installation. If this equipment does cause harmful interference to radio or television reception, which can be determined by turning the equipment off and on, the user is encouraged to try to correct the interference by one or more of the following measures :

- Reorient or relocate the receiving antenna.
- Increase the separation between the equipment and receiver.
- Connect the equipment to an outlet on a circuit different from that to which the receiver is connected.
- Consult the dealer or an experienced radio or TV technician for help.

**CAUTION:** Any changes or modifications not expressly approved by the party responsible for compliance could void the user's authority to operate the equipment.

### CANADIAN NOTICE

This Class B digital apparatus meets all requirements of the Canadian Interference-Causing Equipment Regulations.

### AVIS CANADIEN

Cet appareil numérique de la Class B respecte toutes les exigences du Règlement sur le matériel brouilleur du Canada.

### European Union Notice

Products with the CE Marking comply with both the EMC Directive (89/336/EEC) and the the Low Voltage Directive (73/23/EEC) issued by the Commission of the European Community.

Compliance with these directives implies conformity to the following European Norms (in brackets are the equivalent international standards):

- EN55022 (CISPR 22) - Electromagnetic Interference
- EN55024 - Immunity Test for ITE Product
- EN60950 (IEC950) - Product Safety
- EN61000-3-2 (IEC555-2) - Power Line Harmonics

As an ENERGY STAR<sup>®</sup> Partner, Daewoo Lucoms co., Ltd has determined that this product meets the Energy Star<sup>®</sup> guidelines for energy efficiency.

The product is also designed for IT power system with phase to phase voltage of 230V.

# CONTENTS

<b>Introduction</b> .....	1
<b>Product Features</b> .....	2
<b>Setup</b> .....	3
<b>Connecting the 15 Pin Signal Cable and Power Cord</b> .....	3
<b>Operation &amp; Adjustment</b> .....	4
<b>Specifications</b> .....	11
<b>Factory Preset Timings</b> .....	12
<b>Changing the Stand</b> .....	13
<b>Troubleshooting</b> .....	15

# INTRODUCTION

This manual explains how to correctly install, operate and get the best performance from your monitor. Please read this user's guide carefully before installing your monitor, then keep it near your monitor for quick reference.

First, please check that the contents of the box corresponds with the following checklist :

- TFT LCD monitor
- Power cord
- 15 pin signal cable
- Audio cable(mini-jack)
- User's guide
- Warranty card(optional)
- DVI cable(optional)

If any item is missing or damaged, please contact your dealer. Please keep the box and packing materials so that you may properly store or transport your monitor.

## PRODUCT FEATURES

- The monitor is designed for use in a small work area or for those who need more work space on the desk.
- The convenient and user-friendly on-screen display allows for easy and accurate adjustments of screen size, position and screen color.
- The monitor complies with the VESA Display Data Channel (DDC) specification for Plug and Play compatibility. Advanced microcircuitry makes setup and configuration fast and effortless.
- The monitor features Advanced Color Controls for fine-tuning to meet your own personal tastes or application requirements. Use the on-screen controls to adjust the color temperature, RGB gain value for the best possible screen color and intensity.
- Press the menu button and activate the Self-Diagnosis menu to determine whether your monitor is functioning normally, not receiving a signal or is receiving a signal that is out of scanning range.
- Activate the higher refresh rates of the monitor to stabilize the screen and eliminate the annoying flicker that contributes to eye-strain and headaches.
- The monitor supports the optimal display performance with 1280x1024 at 75Hz.
- The internal stereo speakers make the end user enjoy audio sound.
- With the POWER LIGHT function added, you can enjoy the bright screen for movie or any other multimedia utilization.
- The monitor features VESA Analog signal cable and DVI digital video cable functions. (Digital Visual Interface-Digital)

# SETUP

## CONNECTING THE 15 PIN SIGNAL CABLE AND POWER CORD

- ① Plug the power cord into the AC receptacle located on the back of the monitor.
- ② Connect to the DVI port of the video card in your computer.(DVI cable is optional)
- ③ Connect the 15 pin signal cable to the output port of the video card in your computer.
- ④ Connect the Audio cable to the sound card of computer.
- ⑤ Headphone jack.

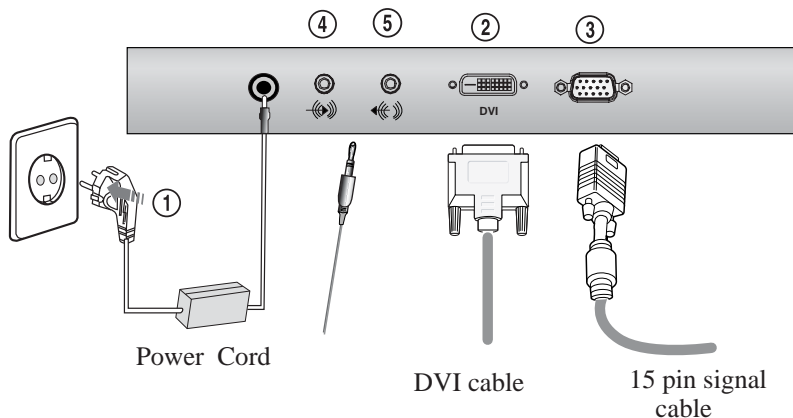

# OPERATION & ADJUSTMENT

## CONTROL PANEL

### 1 POWER

switches the monitor on and off.

### 2 POWER Indicator

shows both normal operation and power management status with power indicator light.

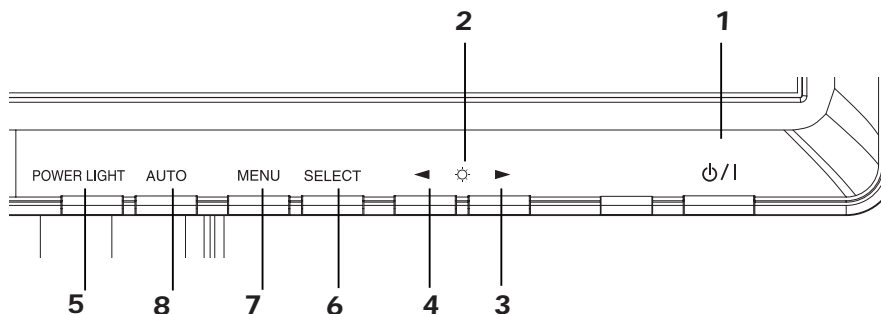

### 3 ►☀ (\*)

Moves cursor to the right or low window in the OSD window and increases the value of any selected function.

#### **BRIGHTNESS (\*)**

While the OSD screen is off, you can adjust the brightness directly.

### 4 ◀ /VOLUME (\*)

Moves cursor to the left or high window in the OSD window and decreases value of any selected function.

#### **VOLUME(\*)**

While the OSD screen is off, you can adjust the volume directly.

### 5 POWER LIGHT (\*)

While the OSD screen is off, you can adjust the screen brightness according to each situation.

### 7 MENU/EXIT

Turns the OSD window on.

#### **EXIT**

Turns the OSD(On-Screen Display) window off and moves from sub menu to top menu in the OSD window.

### 6 SOURCE/SELECT (\*)

Moves from top menu to sub menu in the OSD window and opens the function window for the selected icon.

#### **SOURCE**

While the OSD screen is off, you can select the input signal (Analog/Digital input signal).

### 8 AUTO (\*)

Launches the AUTO TRACKING function directly (Analog mode only).



# KEY PROCESS

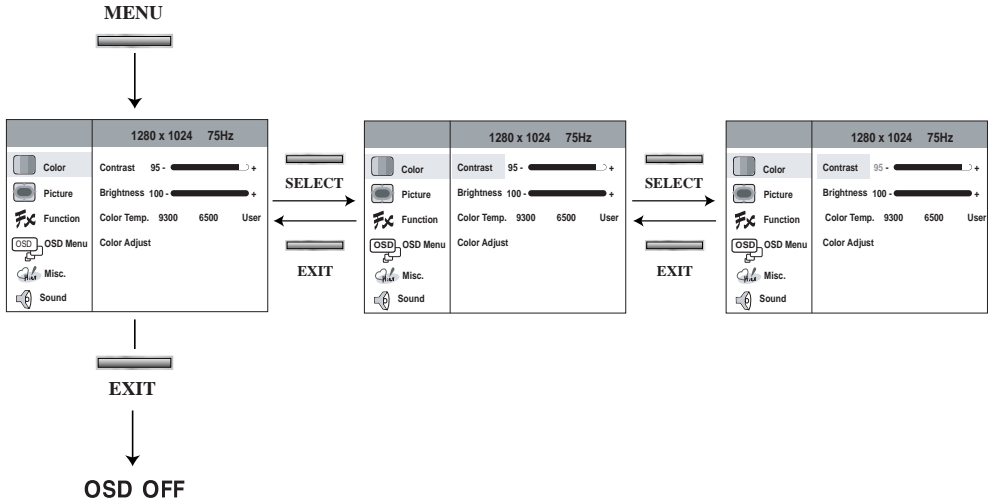

## HOT KEY

### AUTO



- When there is no OSD, if you press this AUTO button, you can use the best display performance fit for a current mode.(Analog mode only).

### BRIGHTNESS

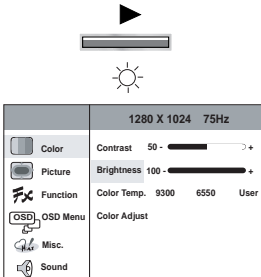

- When there is no OSD, if you press this BRIGHTNESS button, you can adjust the brightness directly.

◀ : decreases brightness

▶ : increases brightness

### POWER LIGHT

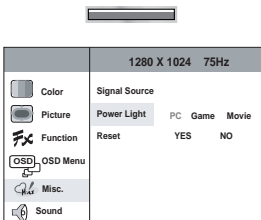

- The screen will be brightened progressively by 10%. If you carry out general PC works such as document edition on the Movie mode,you may shorten the life span of LCD panel. Thus,it is recommended to verify the selected mode before use.

### VOLUME

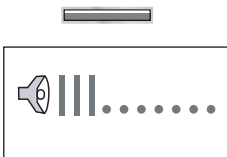

- When there is no OSD, you can adjust the VOLUME directly.

## ADJUSTMENT PROCEDURE

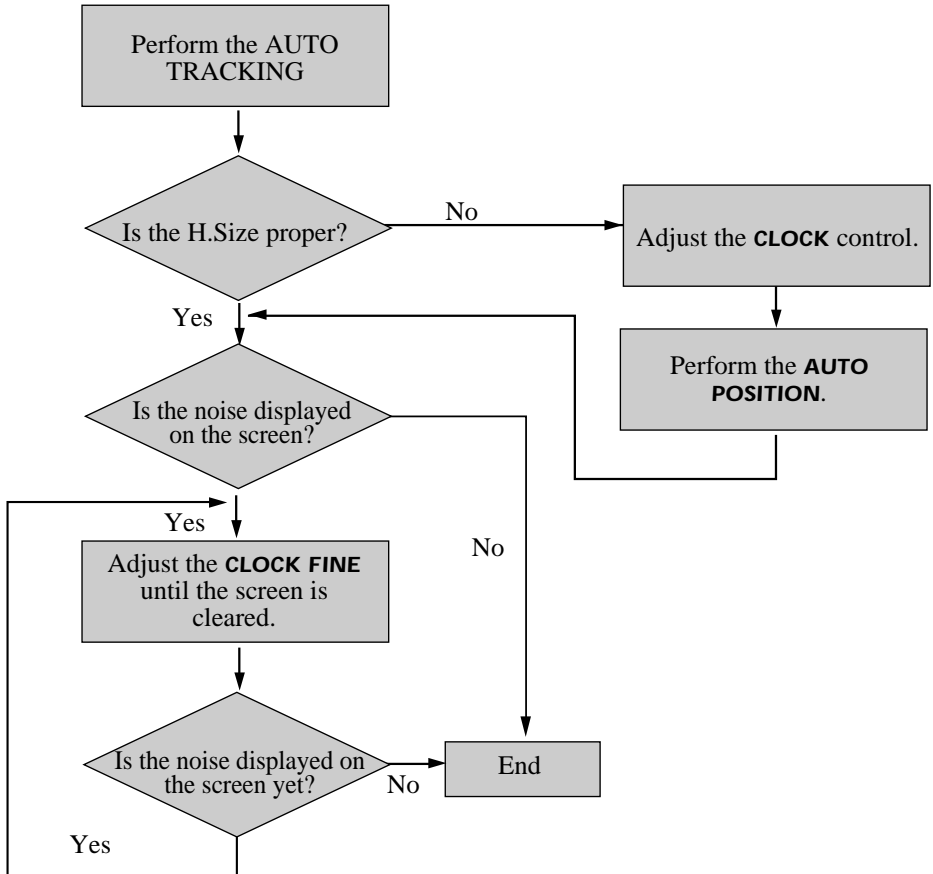

## OSD FUNCTIONS WITH USING PC

### COLOR



#### CONTRAST

Adjust the contrast of image, the difference between light and dark areas on the screen.

#### BRIGHTNESS

Adjust the brightness of image.

#### COLOR TEMP.

Choose different preset color temperatures or set your own customized color parameters.

#### COLOR ADJUST

Adjust the color.

### PICTURE



(Analog mode only)

#### H. POSITION & V. POSITION

Adjust the position of the display horizontally (left or right) and vertically (up or down).

#### PHASE

Remove any horizontal noise and clear or sharpen the image of characters.

#### CLOCK

Adjust the width (horizontal size) of the screen image.

### FUNCTION



(Analog mode only)

#### AUTO Adjust

Choose automatically the proper horizontal position and vertical position & size of the screen image.

## OSD MENU



**LANGUAGE** Select language for OSD.

---

**OSD H & V POS.** Adjust the OSD position horizontally (left or right) and vertically (up or down).

---

**OSD TIMER** Adjust the display OSD Menu.

---

**Tranlucent** Adjust the OSD. Transparency

---

## MISC.



**POWER LIGHT** Select powerlight mode(PC/Game/Movie)

---

**RESET** Reset the screen to the Factory Preset Display Settings.

---

## SOUND



**SOUND** Turn the audio sound on or off.

---

**VOLUME** Increase or decrease audio volume.

---

## SELF DIAGNOSIS

If there is no image, the Self Diagnosis screen will be displayed. Self Diagnosis function checks if the status of the monitor screen is No Signal, Out of range or None support.



No Signal screen is displayed when the D-Sub signal connector is connected but the status of the monitor is on DPMS mode.



Out of Range screen is displayed when the applied frequency is under or over normal range.

- Normal range  
(Non-interlaced mode only)  
H : 30 - 80 KHz  
V : 56 - 77 Hz

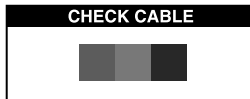

Check cable screen is displayed when the signal cable is disconnected.

# SPECIFICATIONS

<L750>

Panel	Size	17-inch diagonal
	Pixel Pitch	0.264 x 0.264 mm
	Viewing Angle	70°(Right/Left)
		60°(up/down)
	Contrast Ratio	500:1 contrast ratio(typ)
	Brightness	270cd/m <sup>2</sup> brightness(typ)
	Color Filter	RGB vertical stripe
Synchronization	Horizontal	30 - 80 KHz
	Vertical	56 - 77 Hz
Video Bandwidth		140MHz
Max Resolution		1280 x 1024@75Hz
Optimal Resolution		1280 x 1024@60Hz
Colors		16M Colors
Display Area		337.9 mm x 270.4 mm
PC Input Signal	Sync	H/V separate(TTL)
	Video	15 pin mini D-sub(Analog RGB) DVI-D(Digital Visual Interface-Digital)
Audio	I/O	Stereo Mini Jack Input & Output
	Speaker	2W(Left 1W + Right 1W)
Plug and Play		VESA DDC Compatible
Power Source		100-240 Vac, 50/60 Hz(Free Voltage)
Power Consumption		35W
Dimension-W x H x D		386 x 398 x 190 mm(with stand) 386 x 346 x 60 mm(without stand)
Weight-net/gross		4.6/ 6.0 Kg (10.1/13.2 Lbs)
Power Saving		EPA, VESA DPMS, Nutek Compliant
Tilt Range		5° forward, 30° backward
Operating Temperature		10 ~ 40°C /50 ~ 104°F

- The specification can be changed without any prior notice to improve the quality of the product.
- The LCD panel may have some defective pixels (e.g. slightly light or dark) due to a characteristic of the LCD panel. But there is no defect in your LCD product itself.

# SPECIFICATIONS

<L950>

Panel	Size	19-inch diagonal
	Pixel Pitch	0.294 x 0.294 mm
	Viewing Angle	70°(Right/Left)
		60°(up/down)
	Contrast Ratio	700:1 contrast ratio(typ)
	Brightness	300cd/m <sup>2</sup> brightness(typ)
	Color Filter	RGB vertical stripe
Synchronization	Horizontal	30 - 80 KHz
	Vertical	56 - 77 Hz
Video Bandwidth		140MHz
Max Resolution		1280 x 1024@75Hz
Optimal Resolution		1280 x 1024@60Hz
Colors		16M Colors
Display Area		376.3 mm x 301 mm
PC Input Signal	Sync	H/V separate(TTL)
	Video	15 pin mini D-sub(Analog RGB) DVI-D(Digital Visual Interface-Digital)
Audio	I/O	Stereo Mini Jack Input & Output
	Speaker	2W(Left 1W + Right 1W)
Plug and Play		VESA DDC Compatible
Power Source		100-240 Vac, 50/60 Hz(Free Voltage)
Power Consumption		35W
Dimension-W x H x D		386 x 398 x 190 mm(with stand) 386 x 346 x 60 mm(without stand)
Weight-net/gross		5.4/ 7.0 Kg (11.9/15.4 Lbs)
Power Saving		EPA, VESA DPMS, Nutek Compliant
Tilt Range		5° forward, 30° backward
Operating Temperature		10 ~ 40°C /50 ~ 104°F

- The specification can be changed without any prior notice to improve the quality of the product.
- The LCD panel may have some defective pixels (e.g. slightly light or dark) due to a characteristic of the LCD panel. But there is no defect in your LCD product itself.



# FACTORY PRESET TIMINGS

VESA MODES				
Mode	Resolution (dots X lines)	H.Freq (KHz)	V.Freq (Hz)	Remark
VGA	640 X 480@60Hz	31.5	60	Non-interlaced
VGA	640 X 480@72Hz	37.9	72	Non-interlaced
VGA	640 X 480@75Hz	37.5	75	Non-interlaced
SVGA	800 X 600@56Hz	35.2	56	Non-interlaced
SVGA	800 X 600@60Hz	37.9	60	Non-interlaced
SVGA	800 X 600@72Hz	48.1	72	Non-interlaced
SVGA	800 X 600@75Hz	46.9	75	Non-interlaced
XGA	1024 X 768@60Hz	48.4	60	Non-interlaced
XGA	1024 X 768@70Hz	56.5	70	Non-interlaced
XGA	1024 X 768@75Hz	60.0	75	Non-interlaced
SXGA	1280 X 1024@60Hz	64.0	60	Non-interlaced
SXGA	1280 X 1024@75Hz	80.0	75	Non-interlaced
SXGA	1152 X 864@75Hz	67.5	75	Non-interlaced
SXGA	1280 X 960@60Hz	60.0	60	Non-interlaced
IBM MODES				
Mode	Resolution (dots X lines)	H.Freq (KHz)	V.Freq (Hz)	Remark
EGA	640 X 350@70Hz	31.5	70	Non-interlaced
DOS	720 X 400@70Hz	31.3	70	Non-interlaced
MAC MODES				
Mode	Resolution (dots X lines)	H.Freq (KHz)	V.Freq (Hz)	Remark
VGA	640 X 480@67Hz	35.0	67	Non-interlaced
SVGA	832 X 624@75Hz	49.7	75	Non-interlaced
SXGA	1152 X 870@75Hz	68.7	75	Non-interlaced
THE OTHERS				
Mode	Resolution (dots X lines)	H.Freq (KHz)	V.Freq (Hz)	Remark
SXGA	1280 X 1024@70Hz	74.4	70	Non-interlaced

- The LCD Monitor has only Non-interlaced modes without flicker.

# TROUBLESHOOTING

Symptom	Check
<b>Picture is jitterd.</b>	Adjust Clock to set the screen position and adjust Clock fine until a noise isn't displayed.
<b>No picture.</b>	Check if power switch and computer power switch are in the on position. ↓ Check if the signal cable is correctly connected to the video card. ↓ Check if the pins of D subconnector are not bent. ↓ Check if the computer is in the power- saving mode.
<b>POWER LED is not lit.</b>	Check if power switch is in the on position. ↓ Check if the power cord is correctly connected.
<b>Image is unstable.</b>	Check if the signal cable is suitable to the video card.
<b>Image is not centered, too small or too large.</b>	Adjust Clock or H&V Center to get the proper image.
<b>Picture is blurred.</b>	Adjust Contrast and Brightness.
<b>No sound.</b>	Check the audio cable are correctly connected to the computer. ↓ Adjust the volume after checking the sound is muted. ↓ Check the audio system in the computer.
<b>Low sound.</b>	Adjust the volume on the OSD Menu. ↓ Adjust the volume of the sound card in the computer.

S/N:9978641001