



# **BLUEPAD-500 USER GUIDE**



BLUEPAD-500 User Guide

© 2017 Datecs, Ltd.

All rights reserved. No part of the contents of this document may be reproduced or transmitted in any form without the written permission of Datecs, Ltd.

The information contained in this document is subject to change without notice. Although Datecs has attempted to ensure the accuracy of the contents of this document, this document may include errors or omissions. The examples and sample programs are for illustration only and may not be suited for your purpose. You should verify the applicability of any example or sample program before placing the software into productive use. This document, including without limitation the examples and software programs, is supplied "As-Is."

Datecs, the Datecs logo, are registered trademarks of Datecs. Other brand names or trademarks associated with Datecs's products and services are trademarks of Datecs, Ltd. All other brand names and trademarks appearing in this manual are the property of their respective holders.

**Comments?** Please e-mail all comments in this document to your local Datecs Support Team.

Datecs, Ltd.  
4 Datecs Street  
1592 Sofia, Bulgaria

[www.datecs.bg](http://www.datecs.bg)

BLUEPAD-500 User Guide

## Legal Notice

“Made for iPod” mean that an electronic accesory has been designed to connect specifically to iPod, respectively, and has been certified by the developer to meet Apple performance standards. Apple is not responsible fort he operation of this device or its compliance with safety and regulatory standards. Please note that the use of this accesory with iPod.

## Compatibility

### **Made for**

iPod 6<sup>th</sup> generation

iPod touch are trademarks of Apple Inc., registered in the U.S. and other countries. Lightning is a trademark of Apple Inc.

## FCC Notice

### FCC ID: YRWBLUEPAD-500

This device complies with part 15 of the FCC Rules. Operation is subject to the following two conditions: (1) This device may not cause harmful interference, and (2) this device must accept any interference received, including interference that may cause undesired operation.

No changes shall be made to the equipment without the manufacturer's permission as this may void the user's authority to operate the equipment.

### Exposure to Radio Frequency (RF) Signals

The BluePad-500, incorporating the iPod 6<sup>th</sup> generation, has been tested and meets applicable limits for radio frequency (RF) exposure. Specific Absorption Rate (SAR) refers to the rate at which the body absorbs RF energy. The SAR limit is 1.6 watts per kilogram averaged over 1 gram of tissue.

During testing, the iPod 6<sup>th</sup> generation devices, incorporated within the BluePad-500, are set to their highest transmission levels and placed in position that simulate use against the body, with 5mm separation. Carry the BluePad-500 at least 5mm away from your body to ensure exposure levels remain at or below the as-tested levels.

Cases with metal parts may change the RF performance of the device, including its compliance with RF exposure guidelines, in a manner that has not been tested or certified.

The BluePad-500 complies with the FCC safety requirements for RF exposure in accordance with FCC rule part §2.1093 and KDB447498 D01 for portable use conditions.

The BluePad-500, incorporating the iPod 6<sup>th</sup> generation, must not be co-located antennas or transmitters not inherent to the iPod.

## Revision History

Version	Description	Date
1.0	First release	22.08.2014
3.2	Changed barcode engine model and specification	24.11.2015
4.0	Updated all document	11.04.2017

# Contents

<b>LEGAL NOTICE</b> .....	<b>3</b>
<b>FCC NOTICE</b> .....	<b>4</b>
<b>PREFACE</b> .....	<b>8</b>
AUDIENCE .....	8
ORGANIZATION .....	8
RELATED DOCUMENTATION .....	9
<b>CONVENTIONS</b> .....	<b>9</b>
TABLE 1 DOCUMENT CONVENTIONS .....	9
<b>OVERVIEW</b> .....	<b>10</b>
BLUEPAD-500 .....	10
<i>Features At a Glance</i> .....	10
<b>FEATURES AND BENEFITS</b> .....	<b>11</b>
<b>DEVICE SPECIFICATIONS</b> .....	<b>12</b>
<b>DEVICE OPERATION</b> .....	<b>13</b>
<b>SETUP</b> .....	<b>15</b>
SERVICE MODE .....	15
INFO VERSION .....	15
INFO HARDWARE .....	16
INFO KEYS .....	16
TEST DISPLAY .....	16
TEST KEYBOARD .....	16
TEST MSR .....	16
TEST SCR .....	16
KEYS DOWNLOAD .....	16
CLEAR DEA KEYS .....	16
EXIT .....	17
<i>APPLICATION DOWNLOAD MODE</i> .....	17
<i>COMMUNICATION PARAMETERS</i> .....	17
<i>SETTINGS IN APPLICATION(DEPENDS OF THE APPLICATIONS)</i> .....	17
<b>INSERTING A IPHONE IN THE BLUEPAD-500</b> .....	<b>19</b>
<b>BARCODE READER USE*</b> .....	<b>20</b>
<b>MAGNETIC CARD READER USE</b> .....	<b>21</b>
TO CONDUCT A MAGNETIC CREDIT/DEBIT CARD TRANSACTION .....	21

**SMART CARD READER USE**..... **22**

    TO CONDUCT A SMART CARD TRANSACTION ..... 22

**CONTACTLESS CARD READING\*** ..... **23**

    TO CONDUCT A MAGNETIC CREDIT/DEBIT CARD TRANSACTION ..... 23

**DISPLAY SINGS\*** ..... **24**

**TROUBLESHOOTING GUIDELINES**..... **24**

    BLANK DISPLAY..... 24

    KEYPAD DOES NOT RESPOND ..... 24

    TRANSACTIONS FAIL TO PROCESS ..... 25

*Check Magnetic Card Reader* ..... 25

*Check Smart Card Reader*..... 25

    MAINTENANCE AND CLEANING ..... 25

    MAIN BATTERY REPLACEMENT ..... 26

    SERVICE AND SUPPORT..... 26

    SERVICE RETURNS ..... 26

    CONNECTING BLUEPAD-500 FLAT TO BLUETOOTH DEVICE ..... 26

    MOUNTING DEVICE ON BLUEPAD-500 FLAT VERSION ..... 27

    INDIVIDUAL PACKING ..... 29

## PREFACE

This guide is the primary source of information for setting up and installing BLUEPAD-500.

### *Audience*

This guide provides simple descriptions of BLUEPAD-500 features, as well as basic information for anyone installing and configuring BLUEPAD-500.

### *Organization*

This guide is organized as follows:

[Chapter 1, Overview](#). Provides an overview of the BLUEPAD-500.

[Chapter 2, Specifications](#). Discusses power requirements and dimensions of BLUEPAD-500, etc.

[Chapter 3, Setup](#). Explains setup and installation of BLUEPAD-500. This chapter tells how to establish connections with other devices.

[Chapter 4, Maintenance and Cleaning](#). Explains maintenance of BLUEPAD-500.

[Chapter 5, Service and Support](#). Provides information on contacting your Datecs representative or service provider and information on how to order accessories or documentation from Datecs.

[Chapter 6, Troubleshooting Guidelines](#). Provides troubleshooting guidelines should you encounter a problem in terminal installation and configuration.



## Related Documentation



To learn more BLUEPAD-500, refer to the following set of documents:

- *BLUEPAD-500 Physical Security Features*
- *BLUEPAD-500 Firmware API Specifications*
- *BLUEPAD-500 Software Design Specifications*

## CONVENTIONS

Various conventions are used to help you quickly identify special formatting. [Table 1](#) describes these conventions and provides examples of their use.

**Table 1 Document Conventions**

Convention	Meaning	Example
<u>Blue</u>	Text in blue indicates terms that are cross references.	See <a href="#">Guide Conventions</a>
<i>Italics</i>	Italic typeface indicates book titles or emphasis.	You <i>must</i> not use this unit underwater.
	The Information icon is used to highlight important information.	RS232-type devices work on the BLUEPAD-500 Serial communication port.
	The caution symbol indicates hardware or Software failure, or loss of data.	The unit is not waterproof or dustproof, and is intended for indoor use only.
	The warning symbol is used as a warning when bodily injury might occur.	Due to risk of shock do not use the terminal near water.

## Overview

This chapter provides a brief description of Datecs’s BLUEPAD-500 device.

### BLUEPAD-500

The BLUEPAD-500 unit is a handheld PIN pad with an integrated smart and magnetic stripe card reader stripe reader, offering advanced security and smart card processing capabilities.

BLUEPAD-500 supports both symmetric encryption algorithms (DES, 3DES, and AES) and asymmetric encryption (RSA). This device internally manages simultaneous multiple keys through either Master Session- or DUKPT-based processes, and offers high performance smart card processing, as well as support for the new generation of 3-volt cards.

The BLUEPAD-500 sleek and stylish ergonomic design offers power and performance in a smart card and MSR-integrated PIN pad device.



Datecs ships variants of BLUEPAD-500 unit for different markets. Your unit may have a different configuration. However, the basic processes described in this guide remain the same, regardless of configuration.



### Features At a Glance

- Delivers **power** and **usability** in a **small convenient** hand-held design.
- **Security** architecture meets specifications for PIN-entry devices (PED) and sophisticated **file authentication**.

The BLUEPAD-500 provides the right combination of features and functions in a small stylish device that fits in the palm of your hand. This includes a magnetic stripe card reader, smart card reader, an integrated PIN pad, and an optional Bluetooth module.

## Features and Benefits

### Exceptional Ease of Use

- Bold, ergonomic design is sleek, stylish, and lightweight for conveniently handing the unit to the consumer for PIN entry.
- Intuitive interface and large, colored control keys simplify training and reduce support requests.
- Highly readable display handles multiple languages.

### Critical Security Protection

- Incorporates tamper-detection circuitry to resist unauthorized intrusion and supports a broad spectrum of hardware and software-based security features.
- Integrated security modules simultaneously support sophisticated encryption (AES, DES, 3DES, RSA) and key management schemes, including single and 3DES Master Session, single, and 3DES Derived.

### Strong Feature Set

- Primary smart card reader support for synchronous and asynchronous smart cards.
- Support for international character sets and Unicode standard.
- BLUEPAD-500 has received EMV Level 1 approval for smart card solutions.
- BLUEPAD-500 has received PCI PTS 3.x SRED Security Certification.

## Device Specifications

Display	LCD, monochrome, 128 x 32
Keypad	<ul style="list-style-type: none"> <li>• ON / OFF key</li> <li>• 10 numeric keys</li> <li>• 5 functional keys</li> </ul>
Magnetic Card Reader	<ul style="list-style-type: none"> <li>• 3-track bi-directional reading</li> </ul>
Smart Card Reader	Landing type
Contactless Card Reader for payment applications (option)	<ul style="list-style-type: none"> <li>• AMEX ExpressPay MagStripe and EMV</li> <li>• Discover ZIP and D-PAS</li> <li>• MasterCard PayPass MagStripe and M/Chip</li> <li>• VISA PayWave MSD and qVSDC</li> </ul>
Barcode Reader (option)	Newland EM3096 - Image Sensor 640x480 CMOS, High Performance 2D Imager Scan Engine
Supported Barcode Types	<ul style="list-style-type: none"> <li>• 1D Barcode Scanner Supported Symbologies: Code128, UCC/EAN-128, AIM128, EAN-8, EAN-13, ISBN/ISSN, UPC-E, UPC-A, Interleaved 2 of 5, ITF-6, ITF-4, Matrix 2 of 5, Industrial 25, Standard 25, Code 39, Codabar, Code 93, Code 11, Plessey, MSI-Plessey, GS1 DataBarTM(RSS), (RSS-14, RSS-Limited, RSS-Expand) • 2D Imager Supported Symbologies: PDF417, QR Code (QR1/2, Micro), Data Matrix (ECC200, ECC000, 050, 080, 100, 140), Chinese Sensible Code</li> </ul>
Battery	Rechargeable Li-Ion battery 3.7 V / 1300 mAh
Connectivity	<ul style="list-style-type: none"> <li>• Apple 9 pin connector</li> <li>• Pass-through sync through mini USB</li> <li>• Bluetooth 2.0 Class 2 (Option) <ul style="list-style-type: none"> <li>- SPP</li> </ul> </li> <li>• Bluetooth 3.0 Class 2 (Option) <ul style="list-style-type: none"> <li>- SPP</li> <li>- iAP</li> </ul> </li> </ul>
OS compatibility	iOS, Android, Windows, Windows Phone 8, Windows Mobile
Device compatibility	iPod 6 <sup>th</sup> generation
LED indication	4 LEDs for transaction and device status
Audio indication	Electro-Magnetic Buzzer
Buttons	1 scan button
Reliability	<ul style="list-style-type: none"> <li>• 500 000 chip card cycles</li> <li>• 1 000 000 magnetic card swipes</li> <li>• 1 000 000 single button clicks</li> </ul>
Certifications	CE, FCC, EMV Level 1, EMV Level 2, EMV Level 1 Contactless, PCI PTS 3.x, Apple® MFI
Dimensions (LxWxH), mm	145 x 68 x 27 for iPhone5C/iPhone5S 145 x 68 x 23 Flat version
Weight, g	188 for iPhone5C/iPhone5S 182 for Flat version
Environmental	Operating: -10°C to +40°C / 5% to 90% RH Storage: -15°C to +50°C / 5% to 90% RH
Power Supply	<ul style="list-style-type: none"> <li>• 5V through mini USB</li> <li>• 5V through single or 5 station charger</li> </ul>
Accessories	<ul style="list-style-type: none"> <li>• Single station charger - SC-1</li> <li>• 5 stations charger - GC-5</li> </ul>

## Device Operation



*Figure 1*

1. *Scan button*
2. *Keyboard*
3. *Magnetic card reader*
4. *Barcode reader*
5. *Display*
6. *Contactless reader LED indications*
7. *Smart card reader*



*Figure 2*

- 8. *Back cover (slide for insert iPhone)*
- 9. *Volume buttons*
- 10. *Opening for iPhone audio jack*
- 11. *Opening for iPhone back camera*
- 12. *9-pin Lightning connector*
- 13. *10-pin mini USB connector*

The battery is charged by the mini-USB power adapter connector 13, by a USB cable or power station

The BLUEPAD-500 is switched on and off by pressing the  button.

The BLUEPAD-500 comes with a USB communication cable.

The USB communication cable is connected to the BLUEPAD-500's mini-USB connector 1.

## Setup

When a BLUEPAD-500 is switched on and the button  is kept pressed, on the display will be shown the name and the version of the Secure Boot Loader and the firmware.

Service personnel can access two different system modes: **Service Mode** and **Application Download Mode**.

### *SERVICE MODE*

To enter Service Mode for key loading and test operations, the button DOWN has to be pressed while switching on the BLUEPAD-500.

The following keyboard buttons can be used in service mode:

UP: move through the list one position upwards

DOWN: move through the list one position downwards

OK: selection of the active option

C: return to previous level or exit the service mode

The following menu options can be selected in service mode:

INFO VERSION

INFO HARDWARE

INFO KEYS

TEST DISPLAY

TEST KEYBOARD

TEST MSR

TEST SCR

KEYS DOWNLOAD

DELETE DEA KEYS

EXIT

### *INFO VERSION*

Shows the serial numbers and the versions of the detached program modules:

DEV SN BLUEPAD-500 serial number

USIP SN USIP serial number

USIP VER USIP version

ISBL VER USIP Boot loader version

HAL VER USIP Hardware Abstraction Layer (HAL) version

LOAD VER Secure Boot Loader (SBL) version and name

FW VER Firmware version and name

PROM VER Prompts version

APPL VER Application version and name

PKFA VER Version of the public key used for firmware authentication

PKAA VER Version of the public key used for application authentication

PKKA VER Version of the public key used for manufacturing keys authentication

## ***INFO HARDWARE***

Gives information about the status of the following hardware properties:

BATT: indicates the voltage of the 1300 mAh battery

VBUS: indicates if external power supply is plugged in

CHARGE: indicates if the battery is charging

BATLOW: identifies low battery

## ***INFO KEYS***

Shows the version of the following keys:

AIK keys version

## ***TEST DISPLAY***

Performs a display test. Initially a blank screen is displayed. When OK button is pressed once, completely black screen is displayed. When OK button is pressed twice, checkmate background is displayed, its contrast can be changed with the UP and DOWN buttons.

To exit the test at any time the button C has to be pressed.

## ***TEST KEYBOARD***

Performs a keyboard test. At first the symbols of all the keys appear on the display. Pressing a key makes its corresponding symbol to disappear. The test ends when all the buttons have been pressed.

## ***TEST MSR***

Performs magnetic card reading test. The test waits for a card to be inserted. On a successful card reading, the tracks data are displayed.

## ***TEST SCR***

Performs smart card reading tests. On the display appears a menu with the supported options. To perform a test, insert a card in the card slot and select the corresponding menu option:

1: RESET : performs card reset and returns the ATR

2: GET CHALLENGE : calls the command GET CHALLENGE and returns a random number

## ***KEYS DOWNLOAD***

To download the Acquirer Initial Keys (AIK) the PINPAD has to be set in Keys Download Mode, in which it exchanges information in a secure way through the RS-232 interface using proprietary communication protocol. To exit the mode the C button has to be pressed.

## ***CLEAR DEA KEYS***

Deletes the customer's DEA key hierarchy.



## EXIT

Exit the service menu forwarding the control to the application.

## APPLICATION DOWNLOAD MODE

To enter application download mode on the BLUEPAD-500, the button UP has to be maintained pressed while switching on the PINPAD. A characteristic sound is played and on the display appears the name and version of the Secure Boot Loader.

The message - MODE: FW/APP is displayed and the PINPAD listens for application download commands on the serial interface.

When application download is initiated, on the display is shown the progress in percentages of the downloading process.

To exit the mode, press C or  buttons.

The Application download process shall not be interrupted to prevent memory corruption. If the buttons C or  are pressed during the downloading process, the application integrity checking will fail on booting up and process will have to be repeated.

## COMMUNICATION PARAMETERS

The default RS232 serial port communication parameters are the following:

115200bps

8bit

2stop bit

no parity

The default USB VC serial port communication parameters are the following:

115200bps

8bit

1 stop bit

no parity

## SETTINGS IN APPLICATION(DEPENDS OF THE APPLICATIONS)

RS SPEED	115200*
USB MODE	HOST(for connecting with iOS device)/DEVICE/DISABLE
BLUETOOTH	Settings
	Mode: ENABLE/DISABLE
	ADDR: MAC ADDRESS of the Bluetooth
	NAME: Bluetooth name
	PASS: Bluetooth password
	PAIR: DISCOVERABLE/HIDDEN

AUTO: ENABLE/DISABLE

VER: Bluetooth firmware version

MASTER RESET: return to default settings

PAIRING

FW UPDATE

AUTO OFF

60min

HOTSYNC

Disable(Enable or Disable Hot Sync when USB cable is plugged)

CHARGE CURRENT

0mA\*/500mA/1000mA (Select charge current)

***- Hot Sync – iOS device can synchronize data with PC, when USB cable is connected (HOTSYNC ENABLED)***

***- Pass through charge – iOS device only is charging from USB port, when is connected USB cable, communication is remain to BluePAD-500 (HOTSYNC DISABLED)***

***- When charging current is 0mA, charge is disabled***

***- For clear Bluetooth settings use Bluetooth master reset.***

***\*Default settings***

## Inserting a iPhone in the BluePAD-500

Step 1 – slide back cover, like is shown on Figure 3

Step 2 – pull up back cover and insert iPhone

Step 3- pull down back cover and slide back

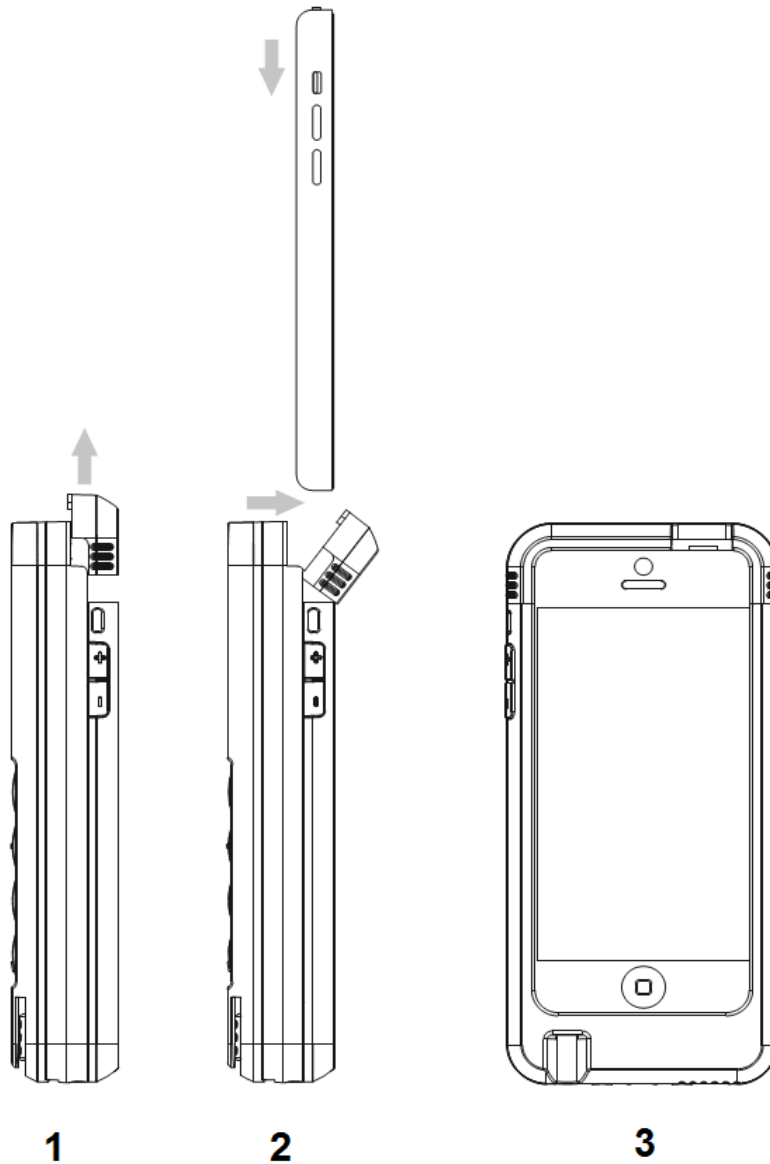
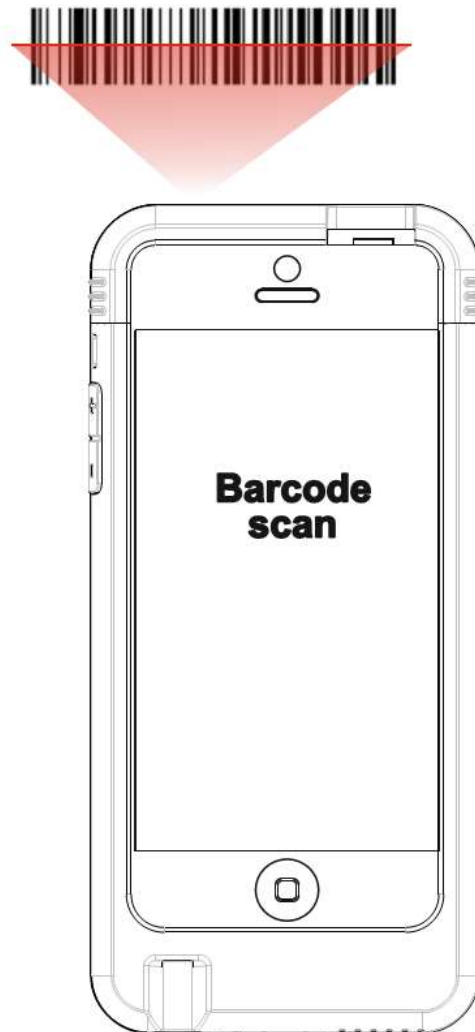

*Figure 3*

## Barcode Reader Use\*

The barcode scanning procedure can vary depending on the POS application loaded on the iPhone. Verify the proper procedure with your POS application provider before performing a barcode scanning procedure.

Point BluePAD-500 with the Barcode scanner facing the barcode and press scan button.



*Figure 4*

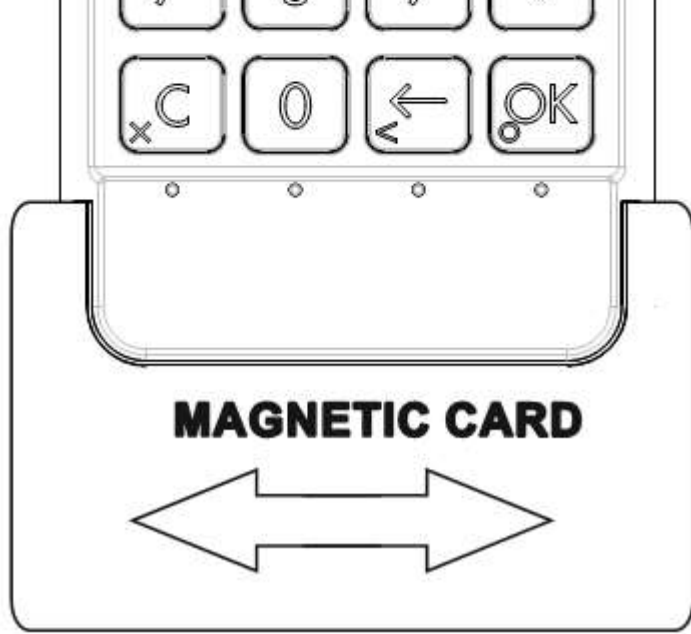

Depending on the application loaded on the application provider before performing a

**Transaction**

(see Figure 5).  
 1. Press the [C] key.  
 2. Press the [0] key.  
 3. Press the [Left Arrow] key.  
 4. Press the [OK] key.

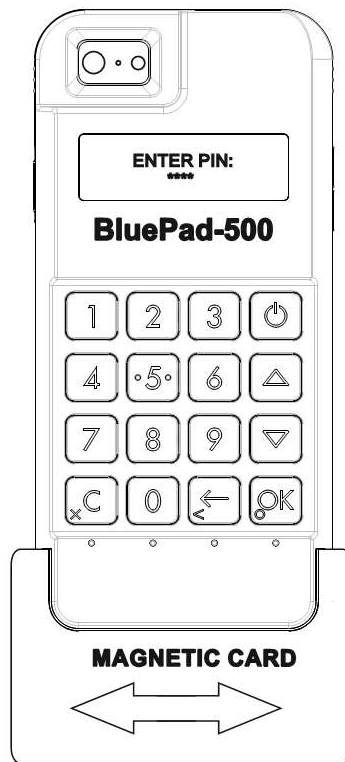

**Figure 5**

## Smart Card Reader Use

The smart card transaction procedure can vary depending on the application loaded on the BLUEPAD-500. Verify the proper procedure with your application provider before performing a smart card transaction.

### To Conduct a Smart Card Transaction

- 1 Position a smart card with the gold contacts facing upward (**Error! Reference source not found.**).
- 2 Insert it into the ICC card reader slot in a smooth, continuous motion until it seats firmly.
- 3 Hand BLUEPAD-500 to customer for PIN entry
- 4 Remove the card when the display indicates the transaction is completed.

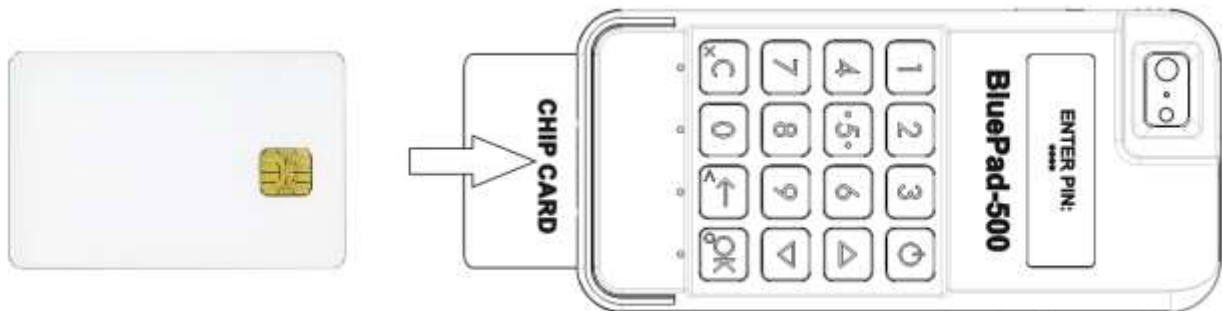

**Figure 6**

Smart card with the gold contacts upward

	Leave the smart card in the card reader until the transaction is completed. Premature removal can void the transaction.
---	---

## Contactless Card Reading\*

The contactless card transaction procedure can vary depending on the application loaded on the BLUEPAD-500. Verify the proper procedure with your application provider before performing a contactless card transaction.

In order to use the Contactless card reading function, special software must be used. Please contact your distributor in order to get the latest demo application and SDK.

### To Conduct a Magnetic Credit/Debit Card Transaction

1. Place a contactless card to shown on the BluePad-500 display contactless logo.
2. Remove the card when the display indicates the transaction is completed.

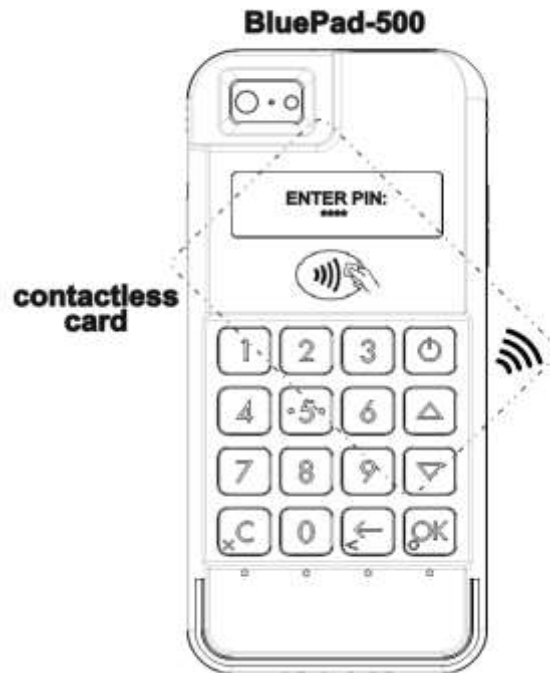

Figure 7

Place the card on the shown spot and press the reading RFID card button on the application. The data will be sent from BluePAD-500 reader to the Apple Device.

*\*Contactless card reader is option*

## Display sings\*

Battery level status:

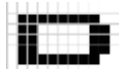

*Battery indication for discharged battery*

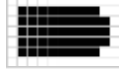

*Battery indication for fully charged battery*



*Outside power from USB cable – “Plug”*



*Battery is charging from UBS cable or Power station – “Flash”*



*“Bluetooth” – active Bluetooth connection*



*“USB” - connection with Apple device*

## Troubleshooting Guidelines

This chapter lists typical examples of malfunction you may encounter while operating your BLUEPAD-500 unit and steps you can take to resolve them.

The troubleshooting guidelines provided in the following section are included to assist successful installation and configuration of BLUEPAD-500 units. If you are having problems operating your BLUEPAD-500 unit, please read through these troubleshooting examples. If the problem persists even after performing the outlined guidelines or if the problem is not described, contact your local Datecs representative for assistance.



The BLUEPAD-500 unit contains no user-serviceable parts. Do not, under any circumstance, attempt to disassemble the unit. Perform only those adjustments or repairs specified in this guide. For all other services, contact your local Datecs service provider. Service conducted by parties other than authorized Datecs representatives may void any warranty.

### *Blank Display*

When the BLUEPAD-500 unit display does not show correct or clearly readable information:

- Check battery power.
- If the problem persists, contact your local Datecs service provider.

### *Keypad Does Not Respond*

If the keypad does not respond properly:



- Check the display. If it displays is not blank, follow the steps outlined in [Transactions Fail To Process](#).
- If the problem persists, contact your local Datecs representative.

## *Transactions Fail To Process*

There are several possible reasons why the unit may not be processing transactions. Use the following steps to troubleshoot failures.

### **Check Magnetic Card Reader**

- Perform a test transaction using one or more different magnetic stripe cards to ensure the problem is not a defective card.
- Ensure that you are swiping cards properly (see [Magnetic Card Reader Use](#)).
- If the problem persists, contact your local Datecs representative.

### **Check Smart Card Reader**

- Perform a test transaction using several different smart cards to ensure the problem is not a defective card.
- Ensure that the card is inserted correctly (see [Smart Card Reader Use](#)).
- If the problem persists, contact your local Datecs representative.

	Due to risk of shock or damage, do not use the BLUEPAD-500 unit near water, including a bathtub, wash bowl, kitchen sink or laundry tub, in a wet basement, or near a swimming pool.
---	--

## *Maintenance and Cleaning*

BLUEPAD-500 units have no user-serviceable parts.

To clean the unit, use a clean cloth slightly dampened with water and a drop or two of mild soap. For stubborn stains, use alcohol or an alcohol-based cleaner.

Do not attempt to clean the card readers. Doing so can void any warranty. For card reader service, contact your Datecs distributor or service provider.

	Never use thinner, trichloroethylene, or ketone-based solvents – they can deteriorate plastic or rubber parts. Do not spray cleaners or other solutions directly onto the keypad or display.
---	--

## ***Main battery replacement***

To replace the main battery of BLUEPAD-500 please contact with your your local Datecs representative or service provider.

## ***Service and Support***

For BLUEPAD-500 problems, product service, and repair information, contact your local Datecs representative or service provider.

- International – Contact your local Datecs distributor

## ***Service Returns***

All customers, please contact your local Datecs representative or distributor for assistance with your service, return, or replacement.

## ***Connecting BluePAD-500 Flat to Bluetooth Device***

Turn on BluePAD-500 and go to setting to enable Bluetooth. Open setting on device which you what to connect to BluePAD-500, and select Bluetooth. Search for BluePAD-500(will shown serial number of the device) and click on connect.

### *Mounting Device on BluePAD-500 Flat version*



*Figure 8*

Mounting hard case on BluePAD-500 Flat, using four screws M1,6x4.



*Figure 9*

## INDIVIDUAL PACKING

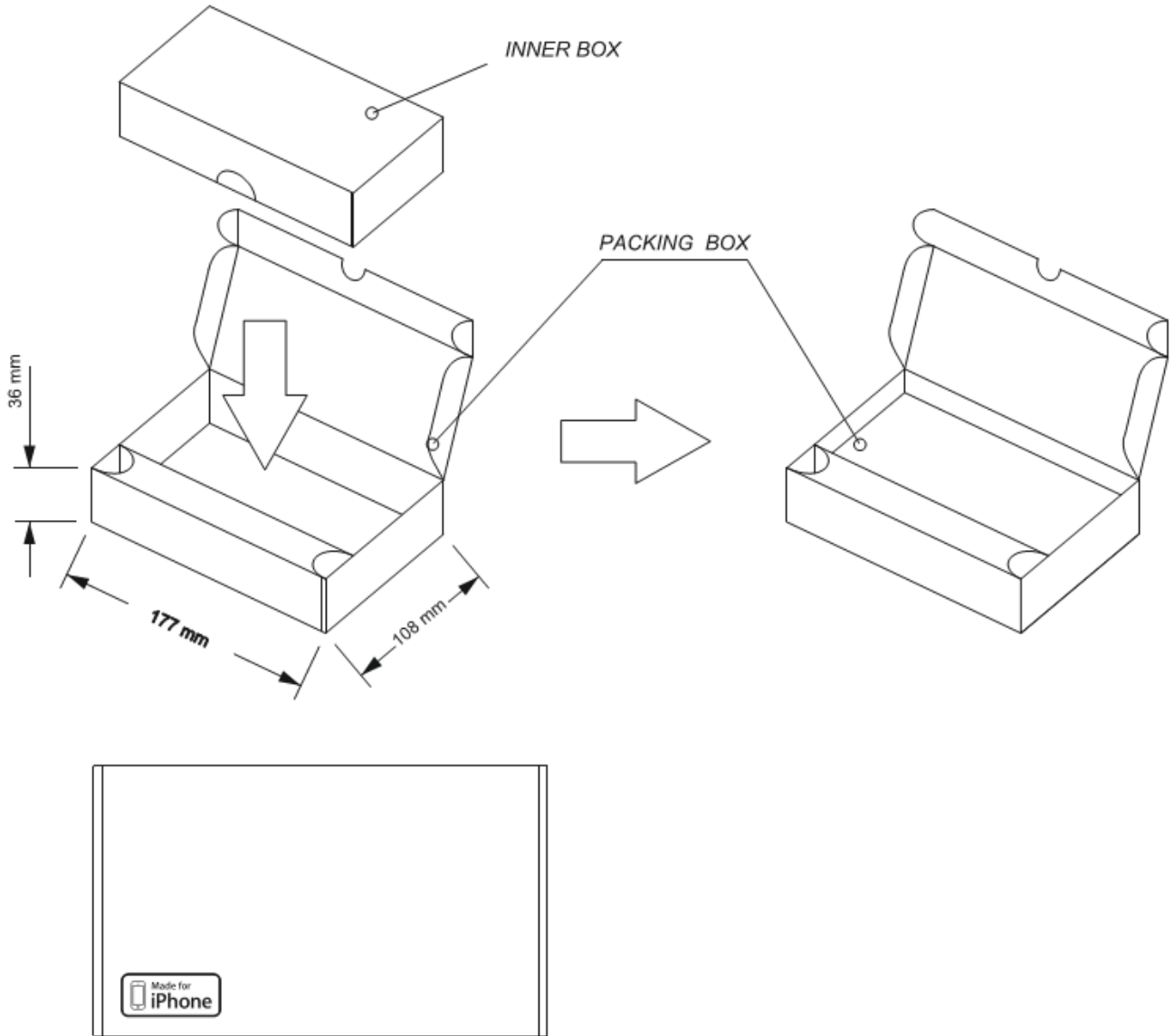

*Figure 10*