

# *User Manual*

---

## **ESC/POS PRINTER DPP-250**



THE INFORMATION IN THIS DOCUMENT CANNOT BE REPRODUCED IN ANY MECHANICAL, ELECTRICAL OR ELECTRONIC WAY AND UNDER ANY CIRCUMSTANCES WITHOUT THE WRITTEN CONSENT FROM DATECS LTD.

VERSION: April 2013

## Legal Notice

“Made for iPod,” “Made for iPhone,” and “Made for iPad” mean that an electronic accessory has been designed to connect specifically to iPod, iPhone, or iPad, respectively, and has been certified by the developer to meet Apple performance standards. Apple is not responsible for the operation of this device or its compliance with safety and regulatory standards. Please note that the use of this accessory with iPod, iPhone, or iPad may affect wireless performance.

## Compatibility

### Made for

- iPhone 5
- iPhone 5S
- iPhone 5C
- iPhone 4S
- iPhone 4
- iPod touch (5<sup>th</sup> generation)
- iPod touch (4<sup>th</sup> generation)
- iPod touch (3<sup>rd</sup> generation)
- iPad (4<sup>th</sup> generation)
- iPad mini
- iPad (3<sup>rd</sup> generation)
- iPad 2

iPad, iPhone, iPod touch are trademarks of Apple Inc., registered in the U.S. and other countries. Lightning is a trademark of Apple Inc.

This equipment has been tested and found to comply with the limits for a Class B digital device, pursuant to part 15 of the FCC Rules. These limits are designed to provide reasonable protection against harmful interference in a residential installation. This equipment generates, uses and can radiate radio frequency energy and, if not installed and used in accordance with the instructions, may cause harmful interference to radio communications. However, there is no guarantee that interference will not occur in a particular installation. If this equipment does cause harmful interference to radio or television reception, which can be determined by turning the equipment off and on, the user is encouraged to try to correct the interference by one or more of the following measures:

- Reorient or relocate the receiving antenna.
- Increase the separation between the equipment and receiver.
- Connect the equipment into an outlet on a circuit different from that to which the receiver is connected.
- Consult the dealer or an experienced radio/TV technician for help.

**CAUTION:** Use shielded cables to connect this device to computers.

Any changes or modifications not expressly approved by the grantee of this device could void the user's authority to operate the equipment.

# CONTENTS

Legal Notice.....	3
Compatability.....	3
1. Technical specification .....	6
2. Box Contents .....	8
3. Compatible Devices.....	8
4. Getting Started .....	9
5. About Your DPP-250 .....	10
5.1 DPP-250 right view 1.....	10
5.2 DPP-250 right view 2.....	10
6. Charging the DPP-250 .....	10
6.1 DPP-250 Charging .....	11
6.1 DPP-250 Full Charge .....	11
7. Status & Operating Modes .....	11
8. Loading Paper .....	12
9. Diagnostic Information.....	13
10. DIP Switch Settings.....	15
10.1 DIP SWITCH SETTINGS: .....	15
10.2 Dip switch Location .....	15
10.3 Memory Switch Settings.....	16
10.4 Setting Memory Switch.....	16
10.5 Memory Switch Details.....	17
11. Pairing Info Details .....	18
11. Communications Configuration .....	18
12. Connecting Device .....	19
12.1 Serial / USB ( Cabled ) Version:.....	20
12.2 BLUETOOTH® Version: .....	20
12.3 BLUETOOTH® Version with iOS Bluetooth.....	20
13. Bluetooth® Setup .....	21
14. Loading Drivers .....	23
15. Magnetic Card Reader (MS Version only).....	25
16. Smart Card Reader (SC Version only).....	25
17. Replacing Battery .....	26
18. Developing Solutions.....	27
19. Troubleshooting.....	28
20. List of commands for ESC/POS mode.....	29

# 1. Technical specification





Printing Method	Direct line thermal	
Print Width	48mm, 384 dots/line	
Dot Density	8 x 8 dots/mm (203 dpi x 203 dpi)	
Print Speed	60mm/sec max	
Fonts	<b>Resident Fonts:</b> Font A: 12 x 24 dots (32 characters/line) Font B: 9 x 16 dots (42 characters/line)	<b>Loadable Fonts:</b> Font C: 12 x 24 dots (32 characters/line) Font D: 9 x 16 dots (42 characters/line) Font E: 24 x 24 dots (16 characters/line) - Japanese vers. only (option) Font F: 24 x 24 dots (16 characters/line) - Chinese vers. only (option)
Graphic Logo	1x Black & White, Size: 384 x 248 dots	
Barcode Types	<b>1D:</b> EAN 13, EAN 8, UPC A, UPC E, Code 39, Code 93, Code 128, Codabar, 2 of 5 interleaved, <b>2D:</b> PDF417, QR code	
Paper spec:	<ul style="list-style-type: none"> <li>• Width: 58mm</li> <li>• Paper roll: φ45mm or less</li> <li>• Thickness: 60-65µm</li> </ul>	
Paper Loading	Easy paper loading	
Paper Feed System	Step	
Connectivity	<ul style="list-style-type: none"> <li>• RS-232C – max 115200bps</li> <li>• Mini USB 2.0 (device)</li> <li>• BT 2.0 Class 2 (option)                             <ul style="list-style-type: none"> <li>- SPP - Serial Port Profile</li> </ul> </li> <li>• BT 3.0 Class 2 (option)                             <ul style="list-style-type: none"> <li>- SPP - Serial Port Profile</li> <li>- iAP - iPod Accessory Protocol</li> </ul> </li> </ul>	
LED Indication	<ul style="list-style-type: none"> <li>• Paper end or paper out</li> <li>• Cover open</li> <li>• Low battery</li> <li>• Print head overheating</li> </ul>	<ul style="list-style-type: none"> <li>• Battery charging</li> <li>• Bluetooth connection</li> <li>• Reading Magnetic card</li> </ul>
Audio Indications	Electro-magnetic buzzer	
Buttons	<ul style="list-style-type: none"> <li>• Power button</li> <li>• Feed button</li> </ul>	

Buffer Size	up to 128 kB
Periphery	<ul style="list-style-type: none"> <li>• Magnetic Stripe Reader                             <ul style="list-style-type: none"> <li>- 3-track bi-directional reading</li> <li>- Compliant with ISO 7810, 7811 and 7813</li> </ul> </li> <li>• Smart Card Reader                             <ul style="list-style-type: none"> <li>- Compliant with ISO7816</li> </ul> </li> </ul>
Emulation	<ul style="list-style-type: none"> <li>• ESC/POS</li> </ul>
Power Supply	<p>AC Adapter</p> <ul style="list-style-type: none"> <li>• Input: AC 100-240V~, 50/60Hz, 0.3A</li> <li>• Output: DC 9V, 1A</li> </ul>
Battery	<p>Rechargeable Li-Ion battery 7.4V / 1150mAh</p> <p>Battery charge time - 2 hours</p> <p>Battery capacity per charge ~ 20 000 lines</p>
Reliability	<ul style="list-style-type: none"> <li>• Thermal head: 50 000 000 pulses or 50km</li> <li>• Chip card: 500 000 cycles</li> <li>• Magnetic card: 1 000 000 swipes</li> </ul>
Weight, kg	<p>0.295 (w/o paper, include battery)</p> <p>0.350 (with paper, include battery)</p>
Dimensions,(WxDxH) mm	86 x 113 x 57 (with magnetic stripe reader)
Environmental	<ul style="list-style-type: none"> <li>• Operating: +0°C to +40°C / 30 to 85% RH</li> <li>• Storage: -20°C to +60°C / 0 to 90% RH</li> </ul>
Drop Test	<p>Height: 1.2m</p> <p>3 times on each of the 6 faces</p> <p>3 times on each of the 4 edges</p>
OS compatibility	iOS, Android OS, BlackBerry OS, Windows OS, Win CE, Windows Mobile, Windows Phone
Accessories	Metal belt clip

**Table 1**

## 2. Box Contents

Your DPP-250 comes with the following items listed below:

Item	Part Number	Descriptions	Image
1.	DPP-250xx	DPP-250 Thermal Printer	
2.	-	AC charger	
3.	-	1 Roll of thermal paper	
4.	-	User's manual, CD with Datecs Software	
5.	-	RS-232 interface cable	

**Table 2**

Software (Drivers & SDK):

Because of the continually evolving Driver & SDK to support new mobile devices, Drivers & SDK are distributed online and is available for download at our website indicated below. For details on using the DPP-250 Drivers & SDK, please refer to the SDK's documentation.

For the latest DPP-250 SDK's, visit our developer web site at:

***<http://www.datecs.bg>***

## 3. Compatible Devices

The DPP-250 (Serial & USB) / DPP-250 (Bluetooth®) portable thermal printer is designed specifically for use with most PDA & Smartphone devices.

The DPP-250 can be used in a variety of applications where Printing/Card Reading is required.



**User Notes:**

*Compatibility depends on the type of communication method "Serial / USB / Bluetooth®" your PDA or Smartphone supports and the availability of DPP-250 driver for your device.*

- *Determine the method of communications your device supports.*
- *Next determine if your device is supported by the DPP-250 Drivers & SDKs.*

*Because of the continually evolving Driver & SDK to support new mobile devices, visit our developer web site at:*

***<http://www.datecs.bg>***

**4. Getting Started**

The DPP-250 allows you to printer information from your PDA & Smartphone. Before using the DPP-250 thermal printer the battery should be properly charged. The following Quick Start guide will help to get your DPP-250 ready for use.

**Quick Start:**

<b>Steps</b>	<b>What to do</b>	<b>Purpose</b>	<b>Where to find more</b>
<b>1</b>	Charge the DPP-250 Rechargeable battery pack as recommended in this manual	The Lithium Ion battery pack should be fully charged before use to ensure long battery life.	Charging Battery, Page 8
<b>2</b>	Load DPP-250 print media (Thermal Paper)	DPP-250 requires Thermal paper for printing.	Loading Paper, Page 9
<b>3</b>	Setup Bluetooth Pairing	Setup Bluetooth® pairing to allow DPP-250 to communicate with Bluetooth®	Bluetooth® Setup, Page 19
<b>4</b>	Install DPP-250 Software	To print information from your device, software needs to be installed onto your device.	Printing software is not provided by Datecs. Please contact your DPP-250 reseller for recommendations on Third-Party solutions. Developers should refer to the section in this manual on "Developing Solutions".

**Table 3**

## 5. About Your DPP-250

### 5.1 DPP-250 right view 1

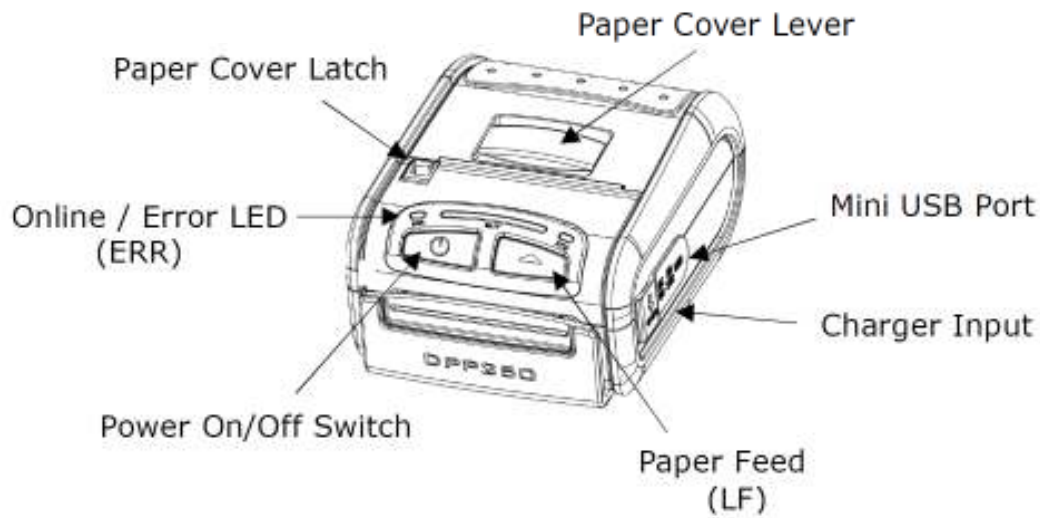

**Figure 1**

### 5.2 DPP-250 right view 2

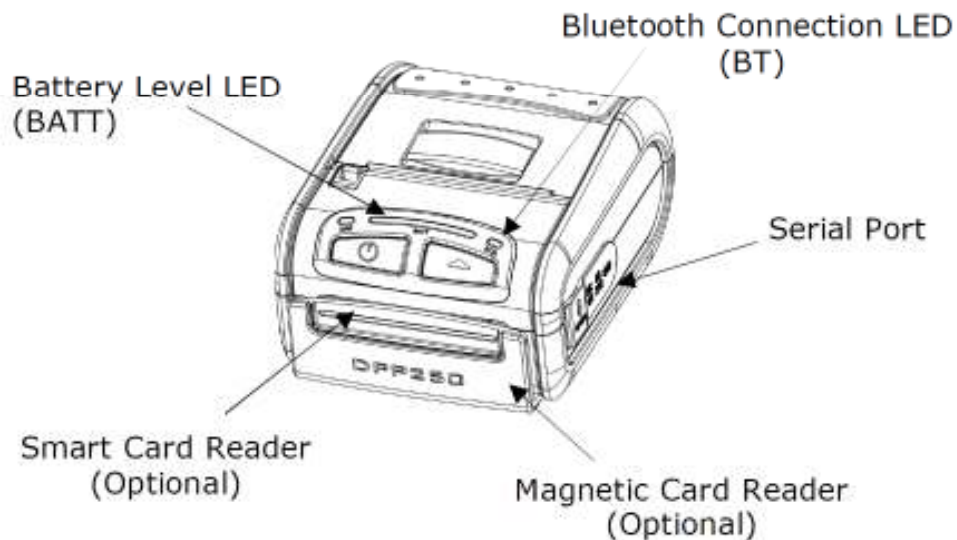

**Figure 2**

## 6. Charging the DPP-250

The DPP-250 uses a Lithium Ion rechargeable battery pack. Before first use, the DPP-250 battery pack should be charged for at least 12 hours.

To prevent electrical damage to the DPP-250 and/or battery pack, please use approved AC Charger only.

### 6.1 DPP-250 Charging

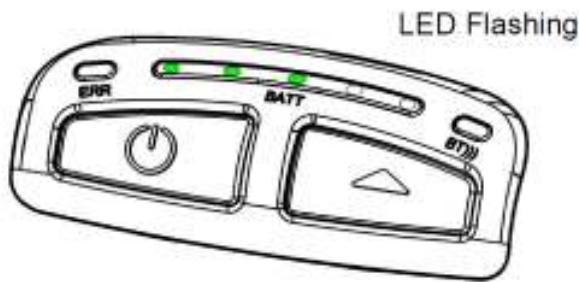

Figure 3

### 6.1 DPP-250 Full Charge

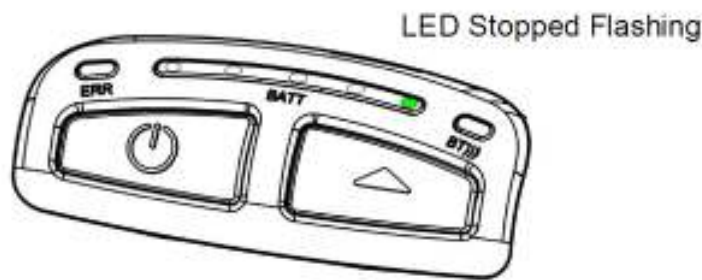

Figure 4

## 7. Status & Operating Modes

The DPP-250 uses LEDs to indicate various conditions of operation. This may be charging, active or online, battery low conditions. The following explains these conditions and LED indication.

LED	Function
<b>ERR</b>	<ol style="list-style-type: none"> <li>1. It lights in <b>green</b> – the printer power is on.</li> <li>2. It lights in <b>red</b> – end of the paper or paper out. After the loading a new paper roll, LED turns <b>green</b>.</li> <li>3. It flashes <b>green/red</b> – the printer thermal head is overheating. The printer stops printing. When the printer head temperature returns to normal the <b>ERR LED</b> lights <b>green</b> and the printer continues to print.</li> <li>4. It flashes <b>green</b> – low battery.</li> <li>5. When switching <b>ON</b> the printer, while the <b>LF</b> button is pressed, <b>red</b> and <b>green</b> lights are rotated after every beep (up to the fifth).</li> <li>6. While long pressing the <b>ON/OFF</b> button it flashes <b>green/red</b> after a beep. After releasing the <b>ON/OFF</b> button it lights green.</li> </ol>
<b>BATT</b>	<ol style="list-style-type: none"> <li>1. When the adapter is switched <b>ON</b> only one of the <b>BATT LED</b> diodes is lighting <b>green</b>, depending on the battery status (from <b>left to right</b> - <b>low battery</b> to <b>fully charged</b> battery). For details see Section "Charging the Battery".</li> </ol>

	<p>2. When the adapter is switched <b>ON</b> the <b>BATT LED</b> diodes are lighting as shown on the illustration in Section "Charging the Battery", up to full battery charging.</p> <p>3. When reading a Magnetic Card, the <b>BATT LED</b> are lighting simultaneously in both directions – from the middle outwards to the left and right.</p>
<b>BT</b>	<p>1. It lights blue when <b>PAIRING</b>.</p>

**Table 4**

## 8. Loading Paper

The DPP-250 uses a drop-and-load design making paper loading easy and trouble free. To load paper, simply lift up the paper cover latch and drop in the new roll as shown in the steps below.

1. Slide the paper cover latch to unlock the paper cover as shown in the figure on the right.



2. Lift the paper cover latch to open the paper cover as shown in the figure on the left.



3. Drop in the new roll of thermal media as shown in the figure on the right.



Be sure to pull at least 12 mm or more of media above the top of the printer before closing.

4. Close the paper cover until it snaps lock.

5. Slide paper cover latch to lock the cover in place.

## 9. Diagnostic Information

The DPP-250's LF switch/button is used for entering various printer modes. These modes can be used to assist developers in debugging problems related to programming and communication. The following explain how to access the various operating modes.

Step #1: Make sure the printer is OFF (On-line LED is OFF) before performing step #2.

Step #2: Press and hold the line feed button (LF). While pressing the (LF) button, press the (POWER) button momentarily and release when one of the conditions below:

LF Button Operation Modes	
Holding LF button while power on for ~ 0.5 sec and releasing it after 1-beep.	SHORT SELF TEST print.
Holding LF button while power on for ~ 2.5 sec and releasing it after 2-beep.	Hex DUMP mode. All input data are printed as hexadecimal.
Holding LF button while power on for ~ 4.5 sec and releasing it after 3-beep.	LONG SELF TEST print.
Holding LF button while power on for more than 8.5 sec and releasing it after the 5-beep (long 4-tone) beep.	Program mode – loading the printer firmware.
Holding ON button while power on for ~ 4 sec and releasing it after 1-beep.	Temporary forcing 9600 bps serial speed.
Holding ON button while power on for ~ 6 sec.	Hardware Setup Mode.

**Table 5**

**Note:** Care must be taken when entering operating modes to prevent the clearing of factory preset configuration information.

### Self-test

The DPP-250 has a built-in test pattern that shows the printer's current configuration as well as the various resident printer fonts. The self-test can also be used as a troubleshooting tool to determine printing problems or battery level. The steps below show how the self-test is printed activated.



- Resident font sizes
- Characters per line
- Text formatting
- Resident character set
- Resident barcode symbols
- Printer's Configuration



## 10. DIP Switch Settings

The DPP-250 is designed to use different methods of communications. Care must be taken to ensure that the DIP Switches are not changed from its default factory configuration unless required.

### 10.1 DIP SWITCH SETTINGS:

The printer has two absolutely different operation modes.

They are determined by the state of switch Sw2:

- Continuous Paper mode
- Black Mark mode

These two modes detect paper present conditions differently. The black mark searching mode is designed for proper alignment of the starting print position on indexed media with printed information.

Switch	OFF	ON
<b>SW1</b>	Enable BT	Disable BT
<b>SW2</b>	Continuous Paper mode	Black Mark mode
<b>SW3</b>	None	Xon/Xoff protocol
<b>SW4</b>	Normal operation mode	Protocol mode

**Table 6**

### 10.2 Dip switch Location

# 1 - Remove battery cover

# 2 - Remove battery

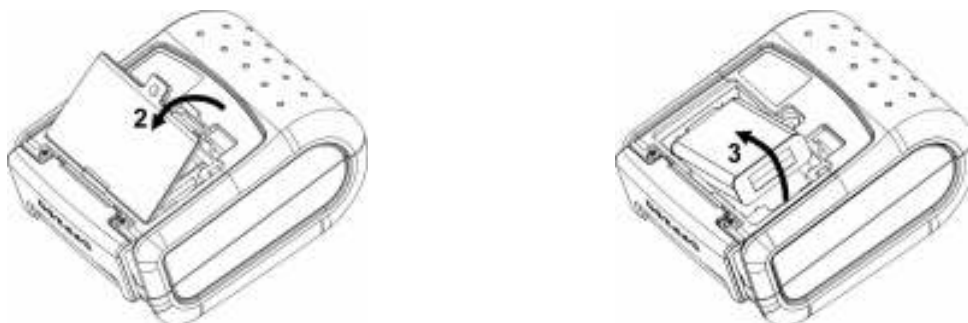

**Figure 9**

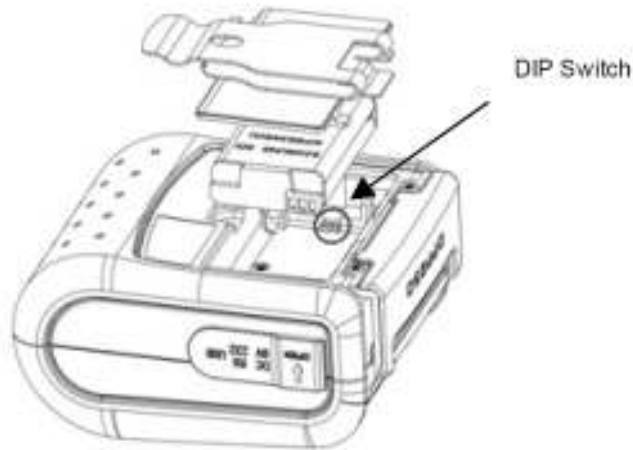

**Figure 10**

### **10.3 Memory Switch Settings**

The DPP-250 uses nonvolatile memory for storing some of the printer default configuration. The following table shows the available options.

<b>Memory Switch Options</b>	
<b>Memory Switch</b> (see command reference GS command)	1000000010
<b>BAUD RATE</b>	115200 bps
<b>POWER OFF TIME</b>	10 minutes
<b>PRINT DENSITY</b>	100%
<b>CHARACTER TABLE</b>	WESTERN (1252)

**Table 7**

### **10.4 Setting Memory Switch**

MEMORY SWITCH SETTINGS:

Step #1: Make sure the printer is OFF (ERR LED is OFF) before performing step #2.

Step #2: Press and hold the power (LF) button. The ERR LED flashes red / green every second.

Step #3: Release the (ON) button in about 6 sec. and wait for the printer to print out the current memory settings. Follow the printer instructions to make the necessary changes.



The pressing LF (YES) – confirms changes.  
 The pressing ON/OFF (No) – cancels changes.

**Note:** Care must be taken when changing factory preset configuration information.

MEMORY SWITCHES: 1000000010  
 BAUD RATE: 115200 bps  
 AUTO OFF TIME: 10 min  
 PRINT DENSITY: 100%  
 CHARACTER TABLE: WESTERN (1252)

**HARDWARE SETUP**  
 <ON/OFF> - NO, <LF> - YES

CHANGE MEMORY SWITCHES ?

SAVE SETTINGS ?

MEMORY SWITCHES: 1000000011  
 BAUD RATE: 115200 bps  
 AUTO OFF TIME: 5 min  
 PRINT DENSITY: 100%  
 CHARACTER TABLE: WESTERN (1252)

**HARDWARE SETTINGS STORED !**

## 10.5 Memory Switch Details

SW1 ENABLE SOUND ?  
 SW2 EXECUTE <CR> AS <LF> ?  
 SW3 DISABLE <CR> COMMAND ?  
 SW4 N/A  
 SW5 N/A  
 SW6 N/A  
 SW7 N/A  
 SW8 DISABLE DISCOVERABILITY ?  
 SW9 ENABLE USB INTERFACE ?  
 SW10 USB IN DEVICE MODE ?

CHANGE BAUD RATE ?  
 CHANGE AUTO OFF TIME ?  
 CHANGE PRINT DENSITY ?  
 CHANGE CHARACTER TABLE ?  
 CHANGE PAIRING INFO ?

SAVE SETTINGS ?

•SW1: Enable/Disable buzzer.

- SW2:** Disable CR / CR is executed as LF
- SW3:** Enable/Disable LF
- SW4:** LF immediately after CR/ Disable LF immediately after CR
- SW5:** Font A (12x24)/ Font B (9x16)
- SW6-7:** Reserved for future features.
- SW8:** Prevents others from discovering printer when set to ENABLE.  
Must be set after pairing is completed.
- SW9:** Disable/Enable USB. Allow the use of USB port for communications.
- SW10:** (OFF) set USB as the host mode. Host/Device

## 11. Pairing Info Details

- BAUD RATE: Default is 115200
- AUTO OFF TIME: Default is 5 minutes
- PRINT DENSITY: Default is 100%
- CHARACTER TABLE: Default is WESTERN (1252)
- PAIRING INFO: Default is (SAVE=No)

### Notes:

*When saving pairing information, the printer remembers Bluetooth information of the last device connected (paired) to the printer. Saving pairing info prevents the printer from asking for passkey upon initialization. The process for using this option is described below. "To speed this programming process, you may bypass the memory switch settings by indicating "NO" via pressing of the <ON/OFF> button when the printer prints "CHANGE MEMORY SWITCHES" as shown on page 17. This will advance you to the next level of setting where pairing can be found".*

1. Following instruction on page-13, change the Pairing Info option to [Save = Yes].
2. Turn the printer on and pair the printer to your Bluetooth device.
3. The printer will now remember the pairing information and not prompt user for a passkey on every printer initialization.

Clearing Pairing Info:

1. Following instruction on page-13, change the Pairing Info option to [Save = No].
2. Turn on the printer and pair the new Bluetooth device to the printer.
3. The printer will prompt user for a passkey on every printer initialization.

## 11. Communications Configuration

The following default configurations are used for the different communication methods.

- Communication with PDA device
- Via Bluetooth/ USB/ Serial:

Memory Switch Options	
Memory Switch ( 1 thru 10 )	*****010
Physical Switch Options	
DIP Switch (1, 2, 3 ,4)	*, OFF, OFF, <b>ON</b>

**Table 8**

- Communication with PC (using windows printer driver)
- Via Bluetooth/ USB/ Serial:

Memory Switch Options	
Memory Switch ( 1 thru 10 )	*****011
Physical Switch Options	
DIP Switch (1, 2, 3 ,4)	*, OFF, OFF, <b>OFF</b>

**Table 9**

- Service mode (changing printer settings, loading firmware) communication with PC
- Via Serial

Memory Switch Options	
Memory Switch ( 1 thru 10 )	*****011
Physical Switch Options	
DIP Switch (1, 2, 3 ,4)	*, OFF, *, <b>ON</b>

**Table 10**

**\* - depending on user requirements can be 1 or 0**

**Notes:** When not using Driver/SDK developer tools, set DIP Switch 4 to OFF.

## 12. Connecting Device

The DPP-250 is designed to use different methods of communications. Care must be taken to ensure that the DPP-250 USB or Serial connector and PDA & Smartphone connector are not accidentally damaged. The figures below show how to attach the different device to the DPP-250.

### 12.1 Serial / USB ( Cabled ) Version:

- Connect the DPP-250 using Mini USB or Serial cable is shown in the figure below.

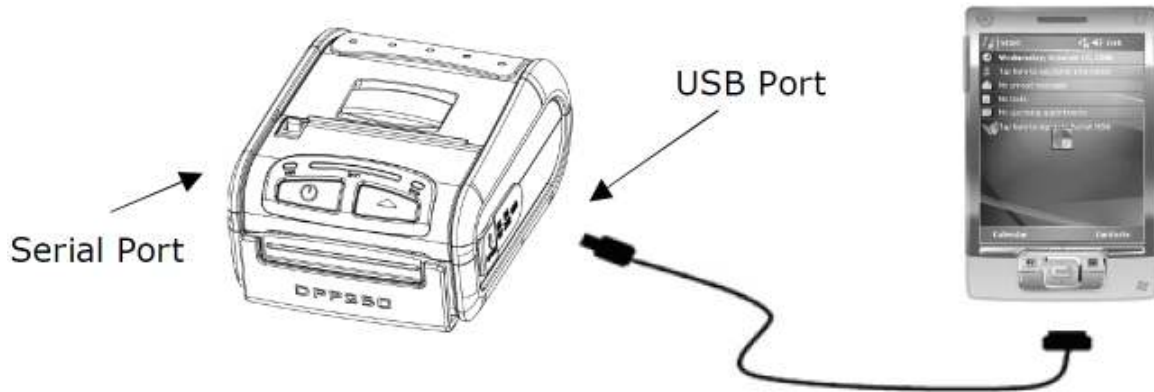

Figure 11

### 12.2 BLUETOOTH® Version:

The DPP-250 Bluetooth® version uses Bluetooth® wireless technology to connect to Bluetooth® enable devices. See page 19 for details on Bluetooth® setup.

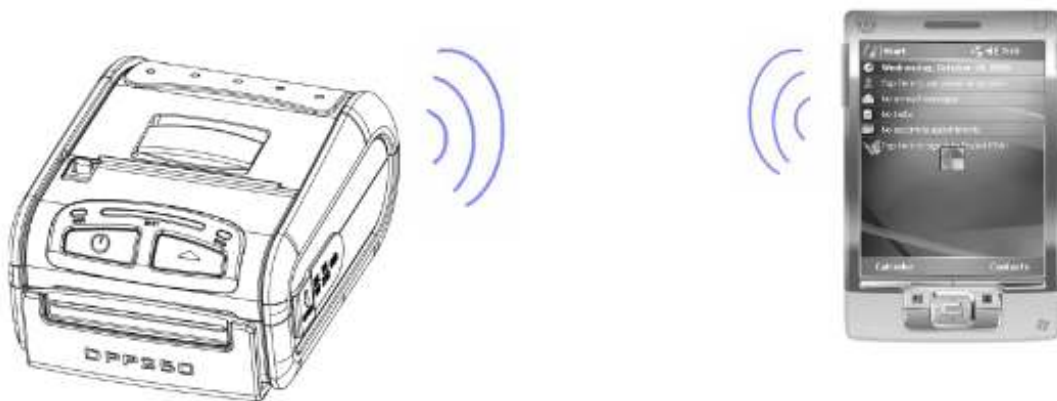

Figure 12

### 12.3 BLUETOOTH® Version with iOS Bluetooth

The DPP-250 Bluetooth® version uses Bluetooth® wireless technology to connect to iOS devices with Bluetooth®.

- iPod 4, iPhone 4, iPhone 4S
- iPod 5, iPhone 5, iPhone 5S
- iPad versions
- iPad mini

**More information on page 20.**

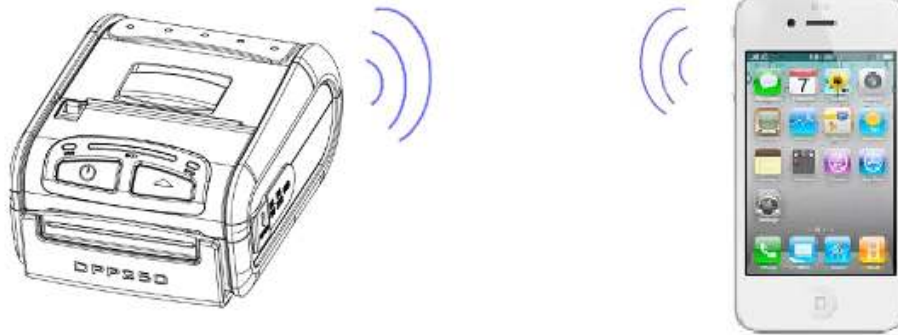

**Figure 13**

### **13. Bluetooth® Setup**

Adding New Bluetooth® Device to PDA or Smartphones

The following is a brief explanation on how to [Pair] your Bluetooth® DPP-250 to PDA, Smartphones and iOS device.

#### **BlackBerry Devices:**

Add Device or Pairing Bluetooth® peripherals to BlackBerry devices require the use of the device Bluetooth® manager. Image on the right shows a typical Blackberry Bluetooth® manager. When adding / pairing the DPP-250, use the [0000] pairing key when prompted.



#### **Windows Mobile Devices:**

Creating a New Partnership or Pairing Bluetooth® peripherals to your Windows Mobile devices require the use of the device Bluetooth® manager. Image on the right shows a typical Windows Mobile Bluetooth® manager. When adding/pairing the DPP-250, use the [0000] pairing key when prompted.

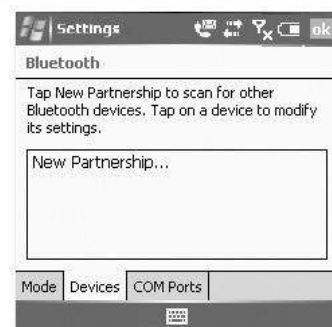

#### **Palm Devices:**

Add Device or Pairing Bluetooth®

peripherals to your Palm devices require the use of the device Bluetooth® manager. Image on the right shows a typical Palm Bluetooth® manager. When adding/pairing the DPP-250, use the [0000] pairing key when prompted.



**iOS Devices:**

Enable Bluetooth on iOS device. Select Bluetooth device, after this Pair to DPP-250. When is connected DPP-250 to iOS device, blue LED on DPP-250 will start blinking. Start app "Library Demo" and select "Print".

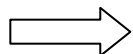
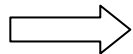

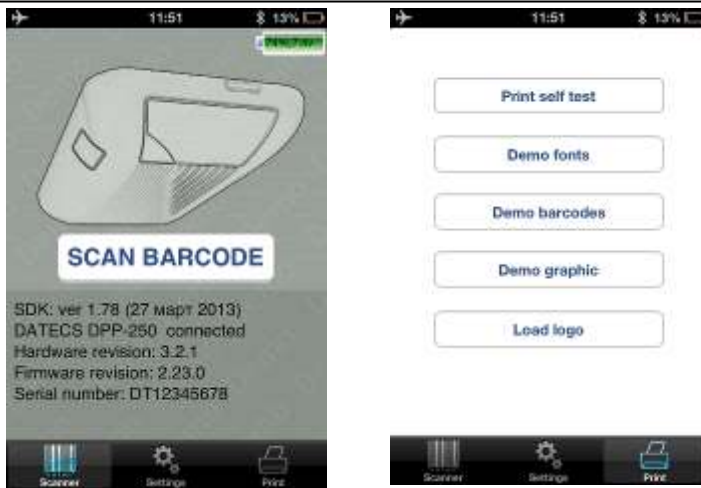

You can select "Print self test" to test Bluetooth connection.

**Android devices:**

Enable Bluetooth and press search device. On the list with available device will show "DPP-250", pair device. Default PIN is "0000". When is paired open application "Printer Sample". Select a device to connect "DPP-250". For test Bluetooth connection press "Print self test".

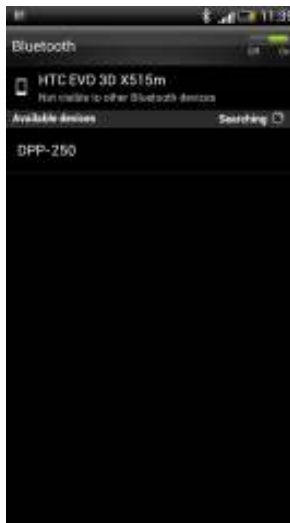

**14. Loading Drivers**

Loading DPP-250 drivers on your PDA or Smartphone.

**BlackBerry Devices:**

Blackberry Desktop Manager shown in the figure on the right is used to load third party software on to your device. Please review your device’s documentation on how to use the Application Loader Option to load software on to your device.



**Windows Mobile Devices:**

Active Sync shown in the figure on the right is used to install third party applications on to your mobile device. Please review your device’s documentation on how to use the Active Sync Manager to load new software on to your device. In most cases you only need to run the DPP-250 installer to start the installation.



**Palm Devices:**

Palm Install Manager Application shown in the figure on the right is used to install third party applications on to your device. Please review your device’s documentation on how to use the Palm Install Manager Application to load new software on to your device. In most cases you only need to drag & drop DPP-250 PRC files in installer and click Add.

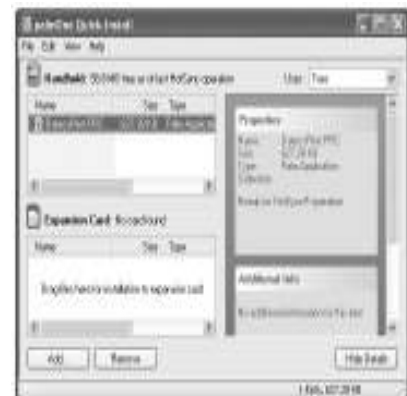



## 15. Magnetic Card Reader (MS Version only)

The DPP-250 has a built-in magnetic card reader. The card reader incorporates a (3)-track magnetic read head requiring a single swipe to read field data from all three tracks.

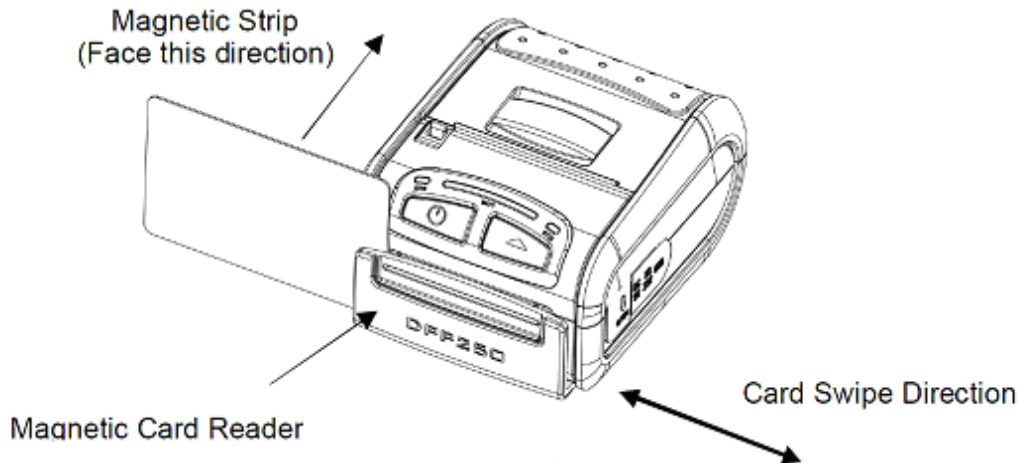

The reader's magnetic head faces towards the front of the printer. When placing the card into the reader, the magnetic strip must be facing as show in the figure above. Keep the bottom edge of the card flat on the inner base of the reader to ensure that the magnetic strip passes over the read head evenly. When swiping the card through the reader, use an even consistent motion from start to finish. The speed of swiping can vary however the speed must be consistent from start to finish of the swipe in order to accurately read card data.

### User Notes:

*To use the magnetic card reader feature, special software must be used to read and process the card information. If you do not have card reading software, please consult your reseller to find out if this software is available or contact DATECS for recommendations on compatible third party software solutions.*

## 16. Smart Card Reader (SC Version only)

The DPP-250 has a built-in smart card reader (optional). The smart card reader is designed to read information stored embedded on smart chips and process the information using device side software.

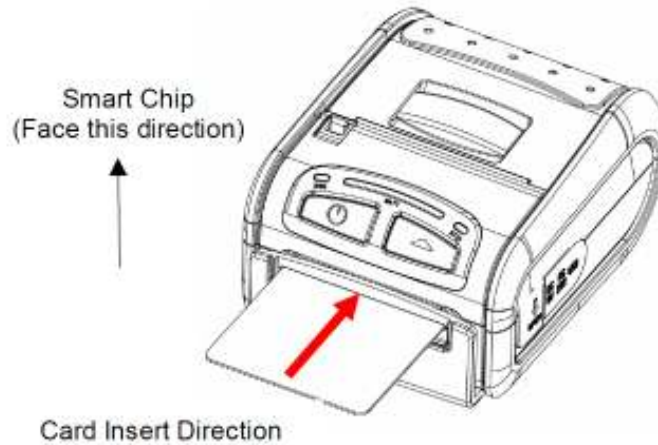

When placing the card into the reader, the smart chip must be facing to the front of the printer as show in the figure above. Insert the card in to the reader until the card stops.

### User Notes:

*To use the smart card reader feature, special software must be used to read and process the smart chip information. Please consult your reseller if this software is available or contact DATECS for recommendations on compatible third party software solutions.*

## 17. Replacing Battery

To replace the battery in the DPP-250 thermal printer follow the steps below.

### Steps:

1. Turn over the DPP-250 and place on a flat surface. Rotate the (2) locking levers as shown in the figure on the right.
2. Lift the battery cover as showed in the figure on the right.



3. Lift the battery as shown in the figure on the right.



4. Detach the battery connector as shown in the figure on the right. Reverse Steps 1-4 to install the new battery pack.



## 18. Developing Solutions

Integrating the DPP-250 into your mobile solution requires the use of the DPP-250 PDA & Smartphone SDK. The SDK incorporates API specific to developing printing applications and using the integrated Magnetic Card Reader / Smart Card Reader capability of the DPP-250.

**The table below shows the SDKs currently available for PDA & Smartphone devices.**

OS	Language	SDK-IDE
<b>Android</b>	Java	Eclipse
<b>BlackBerry</b>	Java	RIM BlackBerry Java JDE 4.1 and higher
<b>iOS</b>	Objective-C	Xcode (Objective-C)
<b>Palm One</b>	C ++	Code Warrior
	Basic	Satellite Forms
	Basic	NS Basic
<b>Windows Mobile</b>	VB.Net	Microsoft Visual Studio 2005 (.Net)
	C ++	Microsoft Visual Studio 2005 (.Net)
	C Sharp	Microsoft Visual Studio 2005 (.Net)

For details on using the DPP-250 SDK, please refer to the SDK's documentation.

For the latest DPP-250 SDK's, visit our developer web site at:

**<http://www.datecs.bg>**

## 19. Troubleshooting

If you're having problems capturing signatures refer to the table below for possible causes.

Item	Problem	Possible Cause
1	Paper feeds after issuing a print job but no printed text visible on paper.	Thermal media is specially coated on outside of roll. Remove paper roll and reload properly. See section "Loading Paper" for details on loading paper.
		Paper cover not installed properly. See Section "Loading Paper" for details on replacing paper cover.
2	On-line LED blinks RED continuously.	Battery voltage low.
		Printer out of paper or Paper not properly loaded. See section "Loading Paper" for details on loading paper.
3	Text and/or graphics are printed very light.	Battery voltage low. See section on charging battery pack.
		Thermal media not imaging correctly. Verify that you are using the recommended thermal media.
4	Strange characters are printed when printing.	Battery voltage low. See section on charging battery pack.
5	Printer stops responding to print and paper feed commands.	Remove battery for 5 seconds and reconnect battery.
6	Printing is light or missing only on half of the print width.	Paper cover not properly installed. See section on loading paper.
		Mechanism jarred loose. Contact technical support.

## 20. List of commands for ESC/POS mode

Nº	Command	Description
1	<b>BEL</b>	Sounds the buzzer
2	<b>HT</b>	Horizontal Tab command
3	<b>LF</b>	Printing a line and Paper Feeding command
4	<b>FF</b>	Printing and paper feeding to the black mark position
5	<b>CR</b>	The operation of the command depends on the state of the configuration flags 2, 3 and 4
6	<b>DC2 =</b>	Image LSB/MSB select
7	<b>DC3 (</b>	DC3 (Ruled line) commands sequence start
8	<b>DC3 +</b>	Sets the ruled line ON
9	<b>DC3 -</b>	Sets the ruled line off
10	<b>DC3 A</b>	Selects ruled line A
11	<b>DC3 B</b>	Selects ruled line B
12	<b>DC3 C</b>	Clears selected ruled line buffer
13	<b>DC3 D</b>	Sets a single dot in selected ruled line buffer
14	<b>DC3 F</b>	Ruled line pattern set
15	<b>DC3 L</b>	Ruled line set
16	<b>DC3 M</b>	Selects ruled line combine mode
17	<b>DC3 P</b>	Ruled line 1 dot line print
18	<b>DC3 p</b>	Ruled line n dots line print
19	<b>DC3 v</b>	Ruled line image write
20	<b>CAN</b>	Canceling print data in page mode
21	<b>ESC FF</b>	Printing data in page mode
22	<b>ESC RS</b>	Sounds the buzzer
23	<b>ESC SP</b>	Setting character spacing
24	<b>ESC #</b>	Setting EURO symbol position
25	<b>ESC \$</b>	Specifying the absolute horizontal position of printing
26	<b>ESC %</b>	Selecting/Canceling the printing of downloaded user character set
27	<b>ESC &amp;</b>	Selecting user character set
28	<b>ESC !</b>	Specifying printing mode of text data
29	<b>ESC *</b>	Printing graphical data
30	<b>ESC +</b>	Switch's OFF the printer
31	<b>ESC -</b>	Selecting/Canceling underlining
32	<b>ESC .</b>	Printing self test/diagnostic information
33	<b>ESC 2</b>	Specifying 1/6-inch line feed rate
34	<b>ESC 3</b>	Specifying line feed rate n/203 inches
35	<b>ESC &lt;</b>	Changes print direction to opposite
36	<b>ESC =</b>	Data input control
37	<b>ESC &gt;</b>	Selecting print direction
38	<b>ESC ?</b>	Reading magnetic stripe card
39	<b>ESC @</b>	Initializing the printer
40	<b>ESC CAL</b>	Black mark mode sensor calibration

<b>41</b>	<b>ESC D</b>	Setting horizontal tab position
<b>42</b>	<b>ESC E</b>	Specifying/Canceling highlighting
<b>43</b>	<b>ESC F</b>	Filling or inverting the page area in page mode
<b>44</b>	<b>ESC G</b>	Specifying/Canceling highlighting
<b>45</b>	<b>ESC I</b>	Specifying/Canceling Italic print
<b>46</b>	<b>ESC J</b>	Printing and Paper feed n/203 inches
<b>47</b>	<b>ESC L</b>	Selecting page mode
<b>48</b>	<b>ESC N</b>	Reading programmed serial number
<b>49</b>	<b>ESC R</b>	Selecting country
<b>50</b>	<b>ESC S</b>	Specifying speed (bps) of the serial port
<b>51</b>	<b>ESC T</b>	Printing short self test
<b>52</b>	<b>ESC U</b>	Selecting/Canceling underlined printing
<b>53</b>	<b>ESC V</b>	Selecting/Canceling printing 90°- right turned characters
<b>54</b>	<b>ESC W</b>	Defining the print area in page mode
<b>55</b>	<b>ESC X</b>	Specifying max printing speed
<b>56</b>	<b>ESC Y</b>	Selecting intensity level
<b>57</b>	<b>ESC Z</b>	Returning diagnostic information
<b>58</b>	<b>ESC \</b>	Specifying relative horizontal position
<b>59</b>	<b>ESC ]</b>	Loading the default settings stored in Flash memory
<b>60</b>	<b>ESC ^</b>	Saving current settings in Flash memory
<b>61</b>	<b>ESC _</b>	Loading factory settings
<b>62</b>	<b>ESC `</b>	Reading the Battery Voltage and Thermal head temperature
<b>63</b>	<b>ESC a</b>	Aligning the characters
<b>64</b>	<b>ESC b</b>	Increasing text line height
<b>65</b>	<b>ESC c5</b>	Enabling/Disabling the functioning of the button LF
<b>66</b>	<b>ESC d</b>	Printing and feeding paper by n- lines
<b>67</b>	<b>ESC i</b>	Feeding paper backwards
<b>68</b>	<b>ESC o</b>	Temporarily feeding paper forward
<b>69</b>	<b>ESC pair=</b>	Enabling/Disabling PAIRING info saving in Bluetooth mode
<b>70</b>	<b>ESC pwd=</b>	Programming a new Bluetooth password (PIN)
<b>71</b>	<b>ESC r</b>	Full command for sounding buzzer
<b>72</b>	<b>ESC s</b>	Reading printer settings
<b>73</b>	<b>ESC u</b>	Selecting code table
<b>74</b>	<b>ESC v</b>	Transmitting the printer status
<b>75</b>	<b>ESC x</b>	Setting the time interval for automatically switching Off the printer
<b>76</b>	<b>ESC y</b>	Setting USB response strings
<b>77</b>	<b>ESC {</b>	Enabling/Canceling printing of 180° turned characters
<b>78</b>	<b>GS FF</b>	Printing in page mode and returning to standard mode
<b>79</b>	<b>GS \$</b>	Specifying the absolute vertical position in page mode
<b>80</b>	<b>GS )</b>	Setting printer flags (memory switches)

<b>81</b>	<b>GS *</b>	Defining a Downloaded Bit Image (logo)
<b>82</b>	<b>GS /</b>	Printing a Downloaded Bit Image
<b>83</b>	<b>GS :</b>	Starting/ending macro definitions
<b>84</b>	<b>GS B</b>	Enabling/Disabling inverse printing (white on black)
<b>85</b>	<b>GS C</b>	Read the Real Time Clock
<b>86</b>	<b>GS H</b>	Selecting printing position of HRI Code
<b>87</b>	<b>GS L</b>	Setting the left margin
<b>88</b>	<b>GS Q</b>	Printing 2-D barcodes
<b>89</b>	<b>GS R</b>	Filling or inverting a rectangle in page mode
<b>90</b>	<b>GS S</b>	Selecting 2-D barcode cell size
<b>91</b>	<b>GS T</b>	Selecting the print direction in page mode
<b>92</b>	<b>GS U</b>	Selecting standard mode
<b>93</b>	<b>GS W</b>	Setting the print area width
<b>94</b>	<b>GS X</b>	Drawing a rectangular box with selected thickness in page mode
<b>95</b>	<b>GS Z</b>	Printing the non blank page area only in page mode
<b>96</b>	<b>GS \</b>	Specifying the relative vertical position in page mode
<b>97</b>	<b>GS ^</b>	Executing macro
<b>98</b>	<b>GS c</b>	Setting the Real Time Clock
<b>99</b>	<b>GS f</b>	Setting the font of HRI characters of the barcode
<b>100</b>	<b>GS h</b>	Setting the height of the barcode
<b>101</b>	<b>GS k</b>	Printing a barcode
<b>102</b>	<b>GS p</b>	Settings for 2D barcode PDF417
<b>103</b>	<b>GS q</b>	Selecting the height of the module of 2D barcode PDF417
<b>104</b>	<b>GS w</b>	Selecting the horizontal size (Scale factor) of the barcode
<b>105</b>	<b>GS x</b>	Direct text print in page mode

### **Asian Languages Support**

<b>106</b>	<b>FS !</b>	Specifying printing mode of two-byte text data
<b>107</b>	<b>FS &amp;</b>	Selecting two-byte text mode (JIS or GB2312)
<b>108</b>	<b>FS -</b>	Selecting/Canceling underline mode for two-byte text mode
<b>109</b>	<b>FS .</b>	Canceling two-byte text mode
<b>110</b>	<b>FS C</b>	Selecting Shift-JIS mode (Japanese version only)
<b>111</b>	<b>FS S</b>	Specifying character spacing for two-byte text mode
<b>112</b>	<b>FS W</b>	Selecting double size characters for two-byte text mode