

### INFORMATION

*In the following conditions, the system may not function.*

- *The cellular phone is turned off.*
- *The current position is outside the communication area.*
- *The cellular phone is not connected.*
- *The cellular phone has a low battery.*

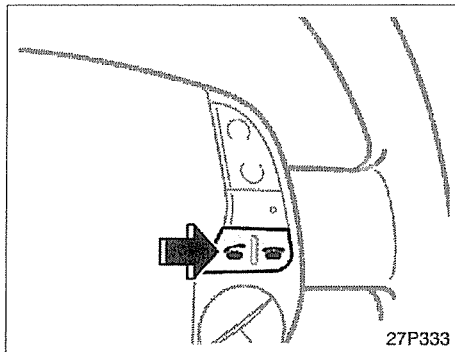

By pushing the telephone button above, you can receive a call or hang up without taking your hands off the steering wheel.

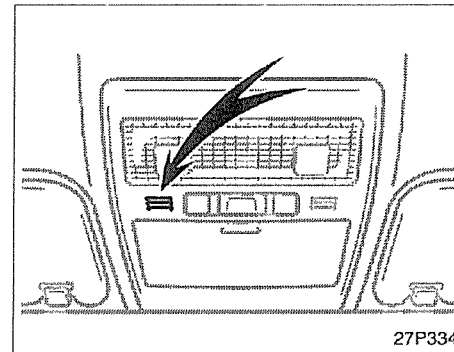

You can use the microphone above when talking on the phone.

The other party's voice outputs from the driver's speaker. When the received calls or received voice outputs, the audio from the audio system will be muted.

### INFORMATION

- Talk alternately with the other party on the phone. If you talk at the same time, the voice may not reach each other. (It is not a malfunction.)
- Keep the volume of receiving voice down. Otherwise, echo is coming up. When you talk on the phone, speak clearly towards the microphone.
- In the following situations, your voice may not reach the other party.
  - ◆ Driving on unpaved road. (Making a traffic noise.)
  - ◆ Driving at the high speed.
  - ◆ The window is open.
  - ◆ Turning the air conditioning vents towards the microphone.
  - ◆ The sound of the air conditioning fan is loud.

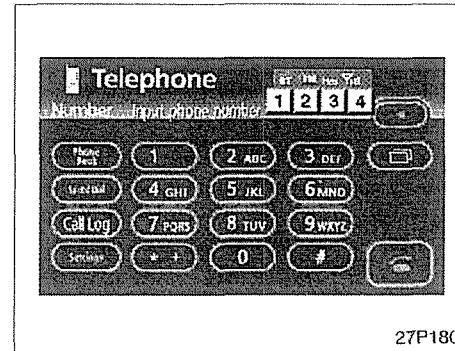

#### 1. Indicates the condition of Bluetooth connection.

“Blue” indicates an excellent connection to Bluetooth.

“Yellow” indicates a bad connection to Bluetooth, resulting in possible deterioration of voice quality.

 : no connection to Bluetooth.

#### 2. Indicates the amount of battery charge left.



It is not displayed while the Bluetooth is connecting or the phone book data is being transferred.

The amount left does not always correspond with the one of your cellular phone. This system does not have a charging function.

#### 3. Indicates the receiving area.

“Rm” is displayed when receiving in Roaming area.

“Hm” is displayed when receiving in Home area.

#### 4. Indicates the level of reception.

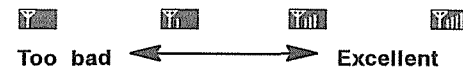

The level of reception does not always correspond with the one of your cellular phone.

### INFORMATION

This system supports the following service.

- HFP (Hands Free Profile) Ver. 1.0
- OPP (Object Push Profile) Ver. 1.1

If your cellular phone does not support HFP, you cannot enter the Bluetooth phone, and take OPP service individually.

An antenna for the Bluetooth connection is built in the display. The indication of the Bluetooth connection may turn yellow and the system may not function when you use the Bluetooth phone in the following conditions and places.

- Your cellular phone is hiding behind the display (behind the seat or in the glove box and console box).
- Your cellular phone touches or is covered with metal materials.

Leave the Bluetooth phone on the place where "Blue" indication is displayed.



Bluetooth is a trademark owned by Bluetooth SIG, Inc.

When you release your vehicle:

A lot of personal data is registered when you use the hands-free system. When you release your vehicle, initialize your data.

If you initialize it, the former state will never come back again. Pay much attention when initializing the data.

You can initialize the following data in the system.

- phone book data
- dialed numbers and received calls
- speed dial
- Bluetooth phone data
- security code

FCC ID : BABBT002A  
IC ID : 2024B-BT002A  
MADE IN JAPAN

This device complies with Part 15 of the FCC Rules and RSS-Gen of the IC Rules. Operation is subject to the following two conditions: (1) this device may not cause harmful interference, and (2) this device must accept any interference received, including interference that may cause undesired operation.

### ⚠ CAUTION

Changes or modifications not expressly approved by the party responsible for compliance could void the user's authority to operate the equipment.

This transmitter must not be co-located or operated in conjunction with any other antenna or transmitter.

This equipment complies with FCC radiation exposure limits set forth for uncontrolled equipment and meets the FCC radio frequency (RF) Exposure Guidelines in Supplement C to OET65. This equipment has very low levels of RF energy that it deemed to comply without maximum permissive exposure evaluation (MPE). But it is desirable that it should be installed and operated with at least 20cm and more between the radiator and person's body (excluding extremities: hands, wrists, feet and legs).

### (a) Entering a Bluetooth phone

To use the hands-free system, you need to enter your phone into the system. Once you have registered it, you can make a hands-free call.

1. Push the "INFO" button to display the "Information" screen.

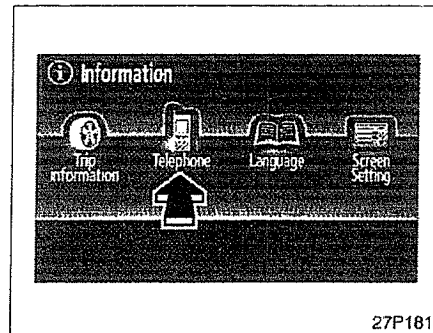

2. Touch the "Telephone" switch to display "Telephone" screen.

You can also push the  button of the steering wheel to display this screen when the vehicle is stopped.

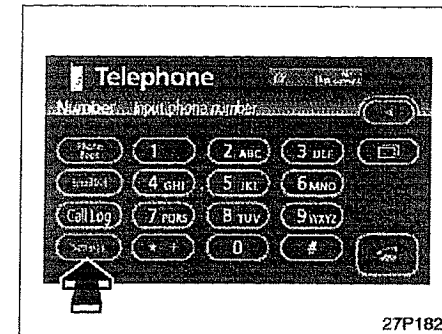

3. Touch the "Settings" switch to display "Settings" screen.

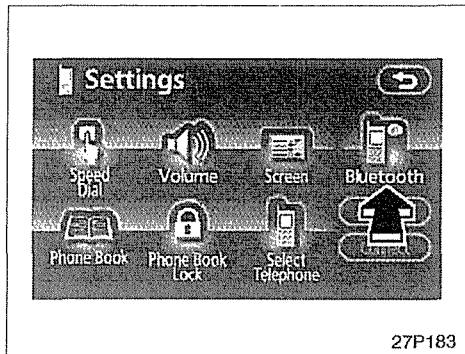

4. Touch the "Bluetooth" switch to display the "Bluetooth Settings" screen.

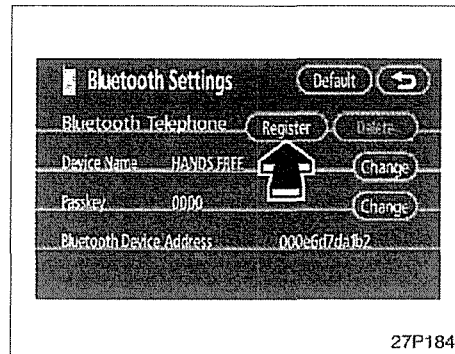

5. Touch the "Register" switch to connect your cellular phone to the system.

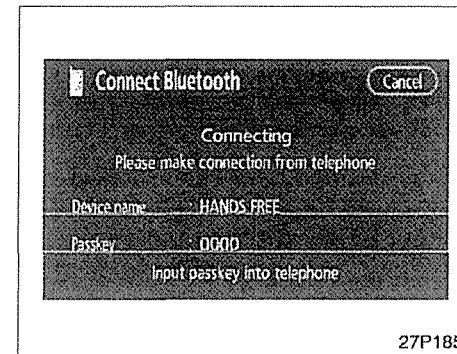

6. When this screen is displayed, input the Passkey displayed on the screen into the phone.

For the operation of the phone, see the manual that comes with your cellular phone.

If you want to cancel it, touch "Cancel".

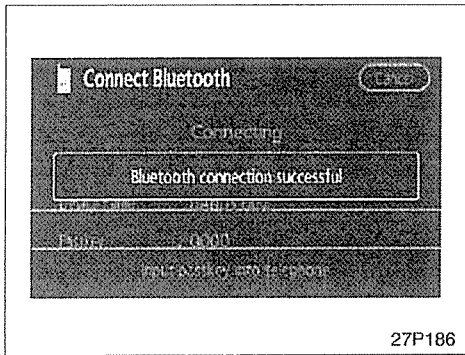

27P186

**7. When the connection is completed, this screen is displayed.**

You do not need to enter the phone in case of using the same one.

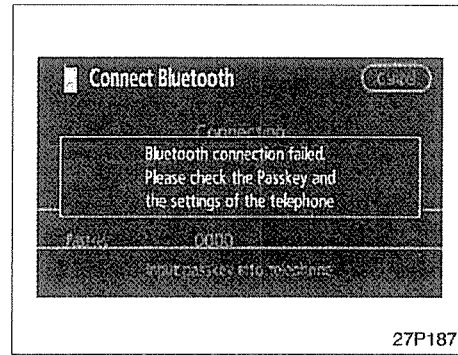

27P187

When this screen is displayed, follow the guidance on the screen to try again.

● **Connecting a Bluetooth phone**  
**(a) automatically**

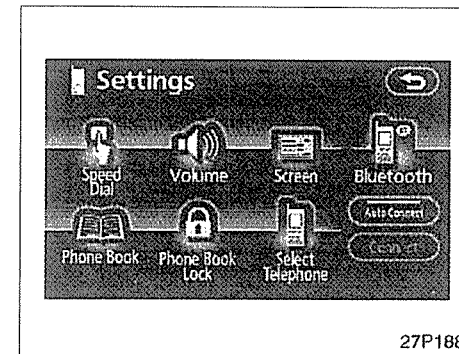

27P188

**When you register your phone, auto connection will be turned on. Always set it to this mode and leave the Bluetooth phone in a condition where connection can be established.**

Each time you touch the "Auto Connect" switch, auto connection will be switched on or off.

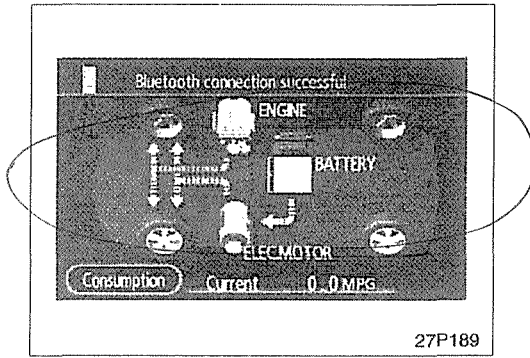

27P189

**When the "ACC" or "IG-ON" mode is enabled, the selected Bluetooth phone will be automatically connected and the connection result is displayed.**

This screen appears when the Bluetooth phone is first connected after the "ACC" or "IG-ON" mode is enabled.

**(b) manually**  
**When the auto connection failed or turned off, you have to connect Bluetooth manually.**

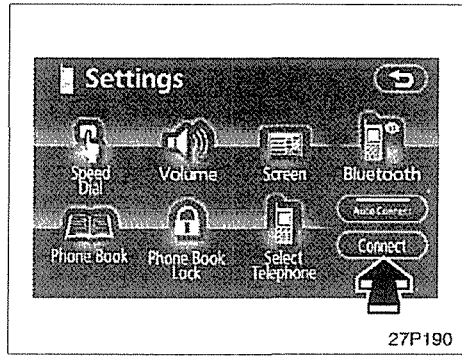

27P190

**Touch the "Connect" switch after having enabled the Bluetooth connection on the phone.**

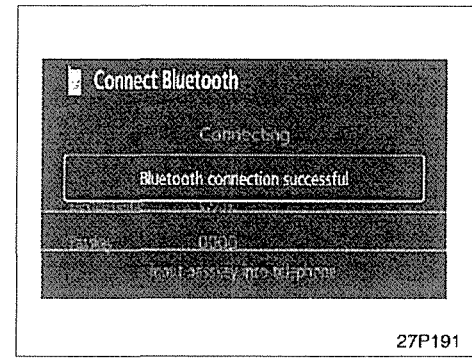

27P191

When the connection is completed, this screen is displayed.

Now you can use the Bluetooth phone.

● **Reconnecting the Bluetooth phone**

If the Bluetooth phone is disconnected with a poor reception from the Bluetooth network when the “ACC” or “IG-ON” mode is enabled, the system automatically reconnects the Bluetooth phone. In this case, the connection result is not displayed.

If the Bluetooth is disconnected on purpose such as you turned your cellular phone off, this does not happen. Reconnect it by the following methods.

- Select the Bluetooth phone again.
- Enter the Bluetooth phone.

**(b) Calling on the Bluetooth phone**

After you enter the Bluetooth phone, you can call by using hands-free system. You can call using the 7 methods described below.

**(i) By dial**

You can call by inputting the telephone number.

This cannot be operated while you are driving.

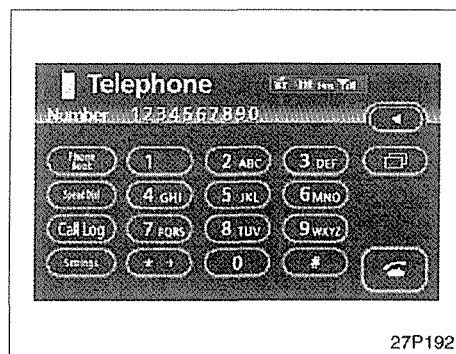

Touch the desired key to input the telephone number.

Each time you touch “◀”, an inputted digit is deleted.

When you touch “☎”, the number you called last is inputted.

Touch “☎” or push the  button of the steering wheel.



(ii) By phone book

You can call by phone book data which is transferred from your cellular phone.

The system has one phone book. You can register up to 1000 numbers.

This cannot be operated while you are driving.

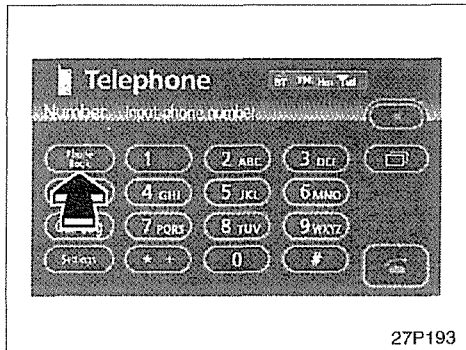

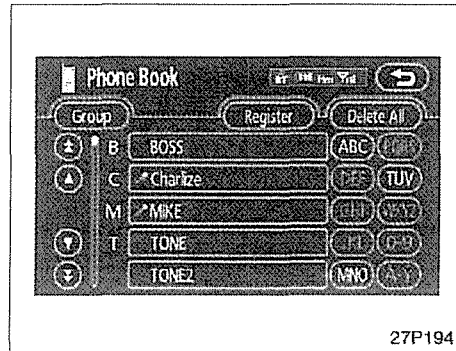

Touch the desired key to input the telephone number.

1. Touch the "Phone Book" switch to display "Phone Book" screen.

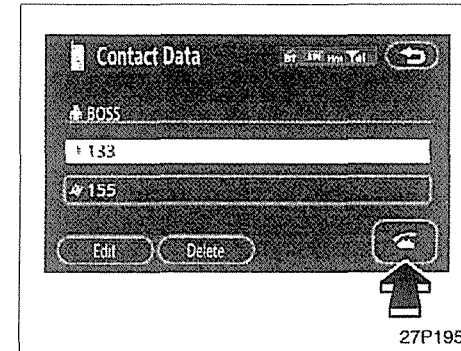

2. Select the desired number from the list.



Touch "☎" or push the  button of the steering wheel.

(iii) By dialed numbers

You can call by dialed number. The system memorizes up to 5 dialed numbers. If it is over 5, the oldest number is deleted.

This cannot be operated while you are driving.

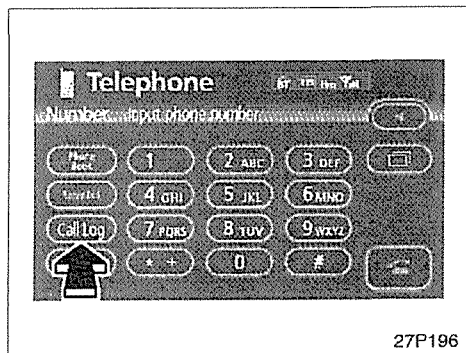

27P196

1. Touch the "Call Log" switch to display "Outgoing Calls" screen.

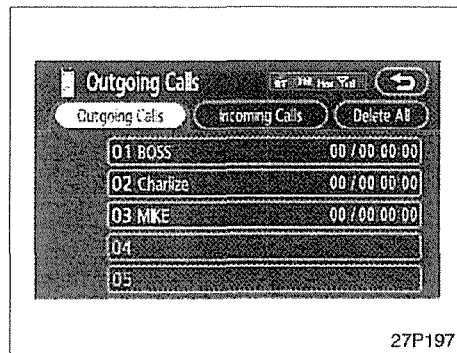

27P197

- When you call by phone book, the name (if registered) is displayed.
  - When you call the same number continuously, only the newest number is registered.
2. Select the desired number from the list.

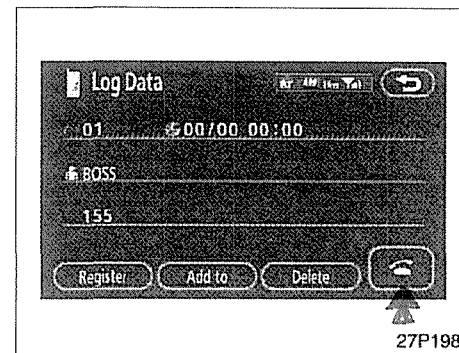

27P198

Touch "☎" or push the  button of the steering wheel.

(iv) By received calls

You can call by received calls. When a call is received, the system memorizes up to 5 numbers. If it is over 5, the oldest number is deleted.

This cannot be operated while you are driving.

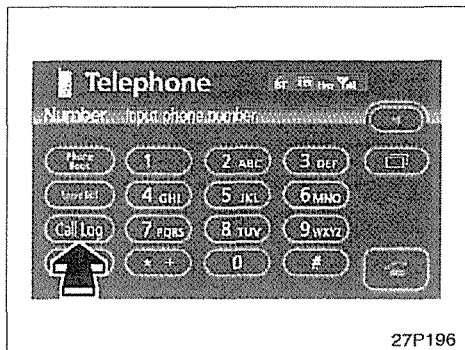

1. Touch the "Call Log" switch to display.

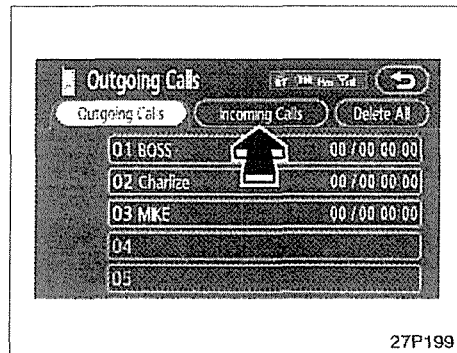

2. Touch the "Incoming Calls" switch to display "Incoming Calls" screen.

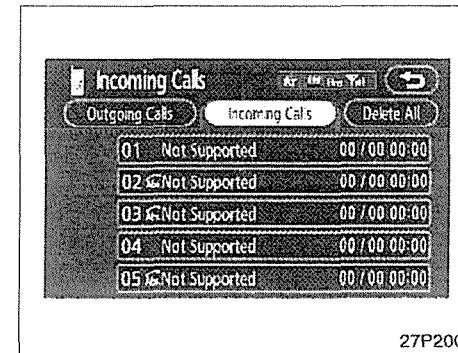

- When a telephone number registered in the phone book is received, the name and the number are displayed.
  - Received calls which you did not answer are also memorized in the system and "Abs." is displayed on the left side of the number.
  - Unnoticed telephone number such as a public telephone is not memorized in the system.
3. Select the desired number from the list.

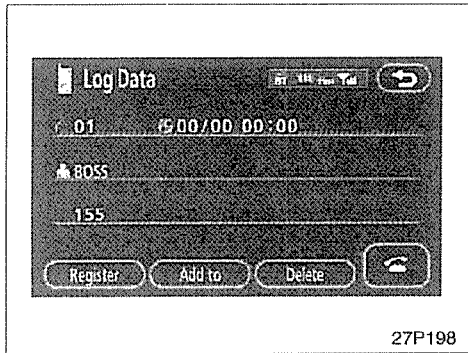

27P198

Touch “☎” or push the button of the steering wheel.

- An international phone call may not be made depending on the cellular phone which you have.

(v) By speed dial

You can call by registered telephone number which you selected from a phone book, dialed numbers and received calls. (See page 192 for registering the speed dial.)

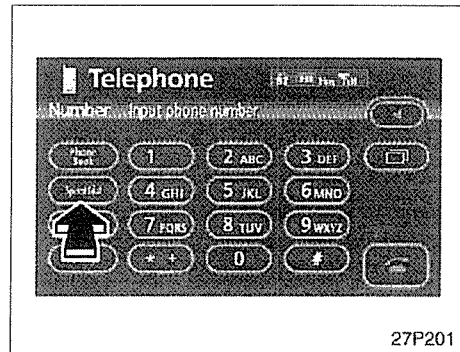

27P201

1. Touch the “Speed Dial” switch to display “Speed Dial” screen.

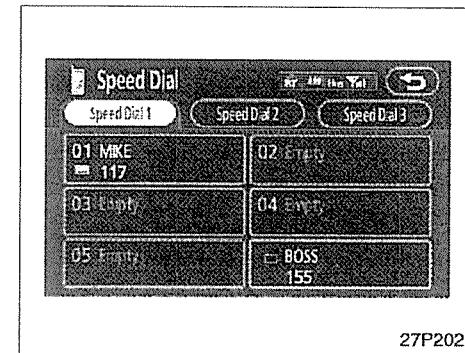

27P202

2. Touch the desired number to call. You can change the page by touching “Speed Dial 2” or “Speed Dial 3”.

When you push the telephone button while you are driving, the screen above appears. Touch the desired name to call. (The telephone number is not displayed.)

**(vi) By voice recognition**

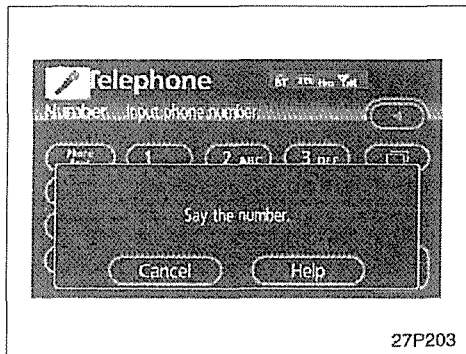

You can call by giving a command. (For the operation and command of voice recognition, see “Speech Command System” on page 236 and “Help screen” on page 238.)

• **Dialing by name**

You can call by giving a voice tag registered in the phone book. For setting the voice recognition, see “Setting the voice recognition” on page 211.

**Example: Call Charlize**

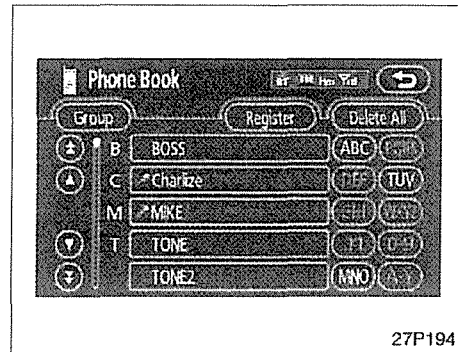

You: Push the talk switch.  
System: “After the beep, please say the name.”  
You: “Charlize.”  
System: “Charlize chosen, when ready, please briefly push the talk switch or push the off-hook switch to dial.”  
You: Push the talk switch.  
System: “After the beep, please say “Dial.””  
You: “Dial.”  
System: “Dialing the name.”  
Now you can call Charlize.

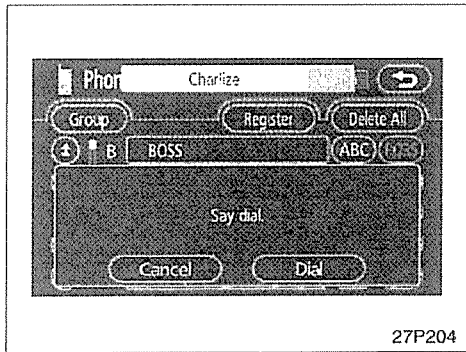

“Next” is displayed when multiple entries are found for a searched name.

Up to 6 entries can be displayed including the first searched one.

Do the following to change the entry to the next one.

- Touch the “Next” switch.
- Push the talk switch to say “Next Candidate”.

**Calling without the voice recognition.**

After the entry number is displayed, you can also call by pushing the telephone button or touching the “Dial” switch.

**Cancelling the voice recognition**

The voice recognition will be cancelled when you do the following.

- Keep on pushing the talk switch.
- Push the  button of the steering wheel.
- Touch the “Cancel” switch. (Except for recognizing the command)
- Say “Cancel”.

• **Dialing by phone number**

You can call by giving a desired number.

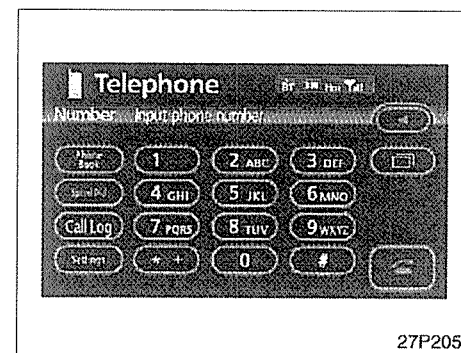

You: Push the talk switch.  
 System: "After the beep, please say the number."  
 You: "812387"  
 System: "When ready, please briefly push the talk switch or push the off-hook switch to dial."  
 You: Push the talk switch.  
 System: "After the beep, please continue to add numbers or say "Dial."  
 You: "Dial."  
 System: "Dialing the number."  
 Now you can call 812387.

● Sending a tone

You can send a tone by giving a desired number.

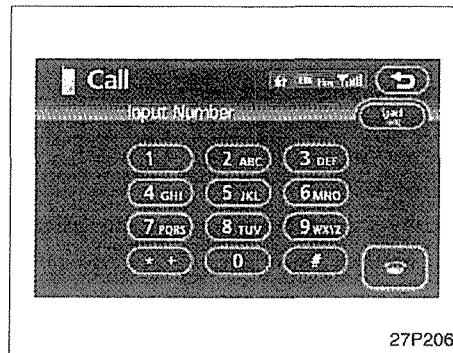

You: Push the talk switch.  
 System: "Say numbers, pound, or star."  
 You: "1234."  
 System: "1234." "Push the talk switch."  
 You: Push the talk switch.  
 System: "Send? Say Yes or No."  
 You: "Yes."  
 System: "Sending."  
 Now you can send the tone.

(vii) By POI call

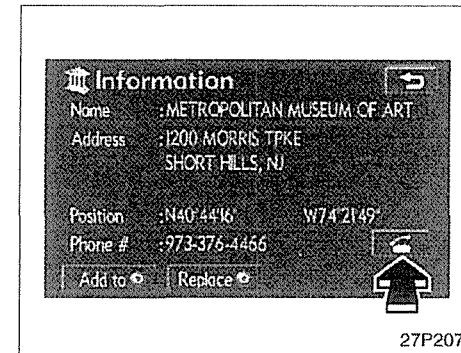

You can call by touching "Call" when it is displayed on the screen from Navigation system. (See the separate "Navigation System Owner's Manual" for details.)

### (c) Receiving on the Bluetooth phone

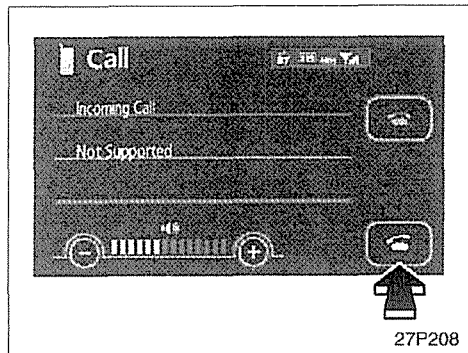

When a call is received, this screen is displayed with a sound. Touch “” or push the button of the steering wheel to talk on the phone.

To hang up the phone:

Touch “” or push the button of the steering wheel again.

To refuse to receive the call:

Touch “” and hold it.

To adjust the volume of received call:  
Touch “-” or “+” or use the volume switch of the steering wheel.

On the international phone call, the other party's name may not be displayed correctly depending on the cellular phone which you have.

### (d) Talking on the Bluetooth phone

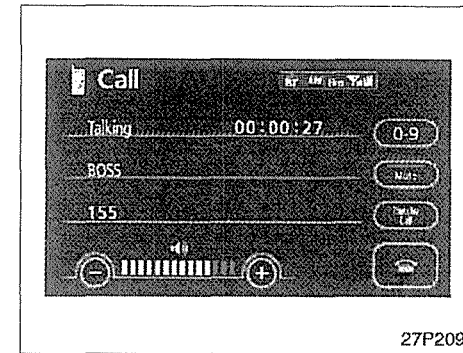

While you are talking on the phone, this screen is displayed. You can do the operations below on the screen.

To adjust the volume of the other party's voice:

Touch “-” or “+” or use the volume switch of the steering wheel.

To hang up the phone:

Touch the “” switch or push the button of the steering wheel

To mute your voice:

Touch the “Mute” switch.



To input a Key:  
Touch the "0-9" switch.

To transfer the call  
Touch the "Transfer Call" switch.

You cannot change from hands-free call to cellular phone call while you are driving.

When you change from cellular phone call to hands-free call, the hands-free screen will be displayed and you can operate it on the screen.

Transferring method and behavior are different depending on the cellular phone which you have.

For the operation of the phone, see the manual that comes with your cellular phone.

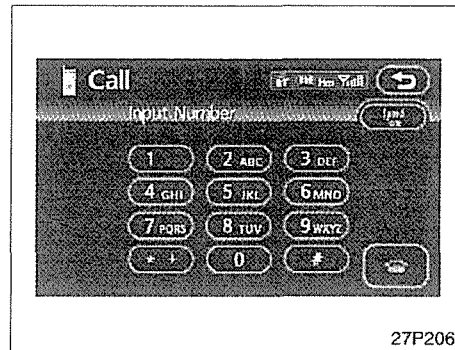

Touch the desired number to input the key.

To hang up the phone:

Touch "☎" or push the  button of the steering wheel.

This cannot be operated while you are driving.

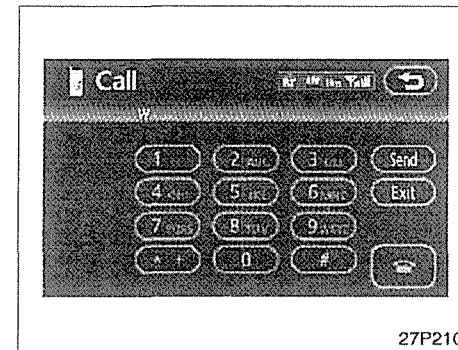

**If the continuous tone signal is registered in a phone book, this screen appears. (If not registered, "Send" and "Exit" are not displayed.)**

**Confirm the number displayed on the screen and touch "Send". The number before marked sign will be sent.**

When you touch "Exit", this function will be finished and normal tone screen appears.

To hang up the phone:

Touch "☎" or push the  button of the steering wheel.

The continuous tone signal is the marked sign (p or w) and the number following telephone number. (ex. 056133p0123w#1:)

You can do this operation when you want to operate an answering machine or use a telephone service in bank for example. You can register the phone number and the code number in the phone book.

● **Sending a tone by the speed tone**  
**You can send a tone by the speed tone.**  
(For registering the speed tone, see “Registering the speed tone” on page 196.)

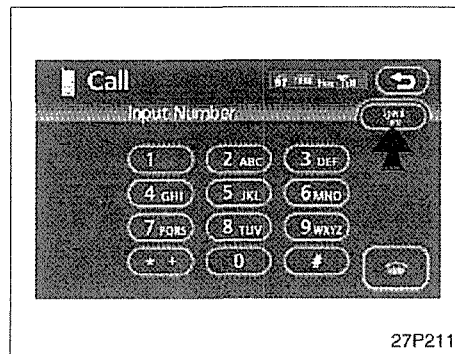

27P211

1. Touch the “Speed Tone” switch.

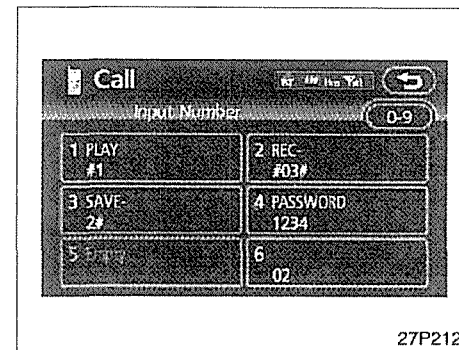

27P212

2. Touch the desired switch to send a tone.

**(e) Changing the settings of the Bluetooth phone**

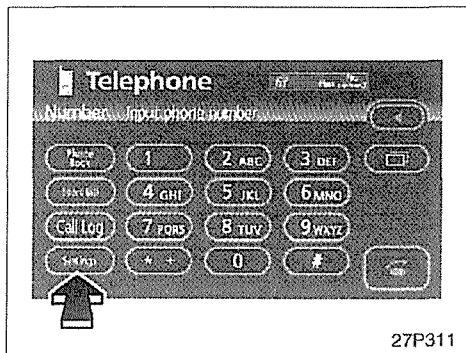

Touch the "Settings" switch to display "Settings" screen.

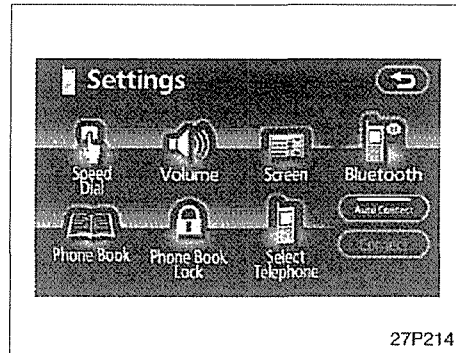

You can change the settings of the phone.

**(i) (a) Registering the speed dial**

You can register the desired telephone number from phone book, dialed numbers and received calls. Up to 17 speed dial numbers can be registered.

The 6th entry is the speed dial for redialing.

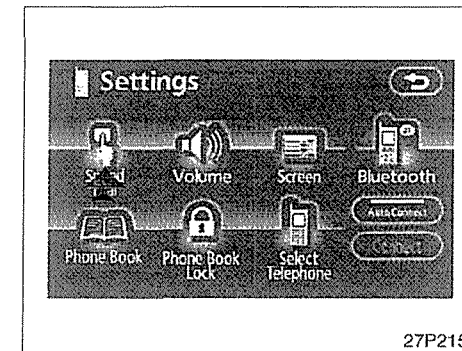

1. Touch the "Speed Dial" switch to display the "Speed Dial Settings" screen.

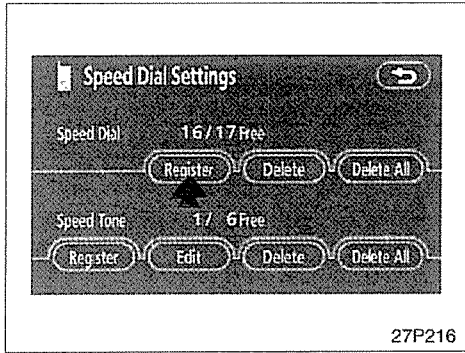

2. Touch the “Register” switch of “Speed Dial”.

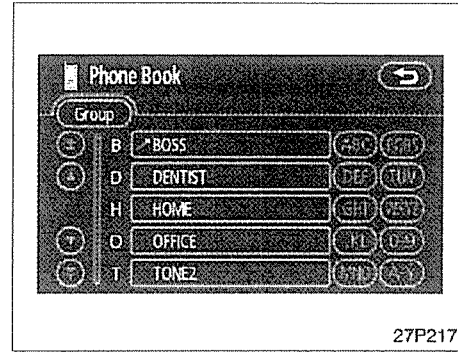

3. Select the data you want to register.

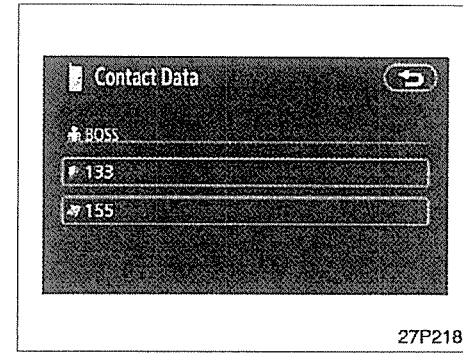

4. Touch the desired telephone number.

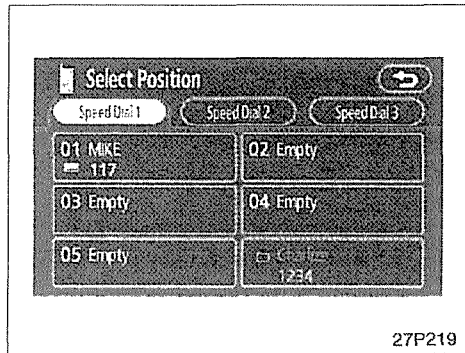

5. Touch the switch you want to register in.

The latest dialed number is registered in the 6th item (speed redial).

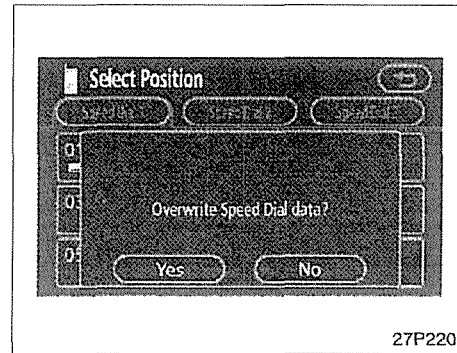

6. If you select a switch you registered before, this screen is displayed.

Touch the "Yes" switch if you want to overwrite it.

• **Deleting the speed dial individually**  
 You can delete "01" - "17" of the speed dial individually.

If you delete them all at once, all of 17 numbers are deleted.

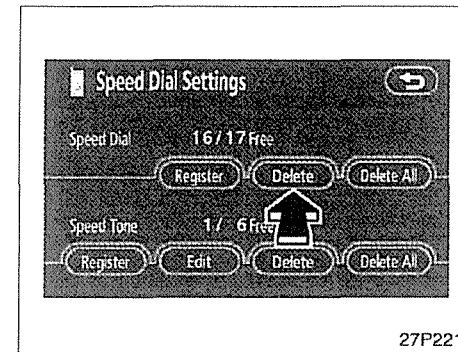

1. Touch the "Delete" switch of "Speed Dial".