

5. Touch the "Yes" switch.

You can also delete it in the following way.

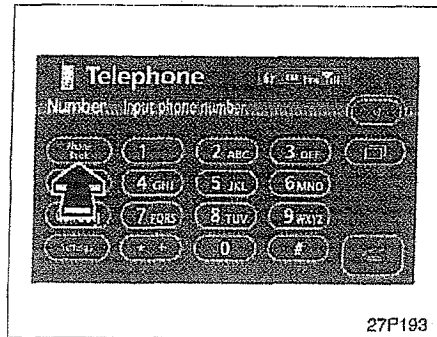

1. Touch the "Phone Book" switch.

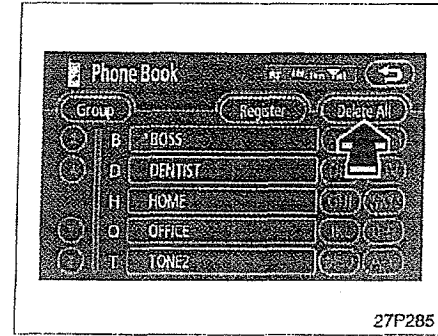

2. Touch the "Delete All" switch.

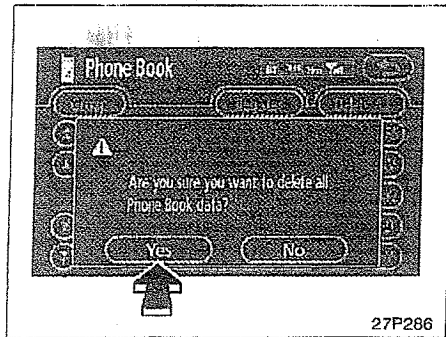

3. Touch the "Yes" switch.

● Registering a group name

You can register 20 groups. "No Group", "Group 01" - "Group 19" are registered by default.

You can change "Group 01" - "Group 19" into desired names.

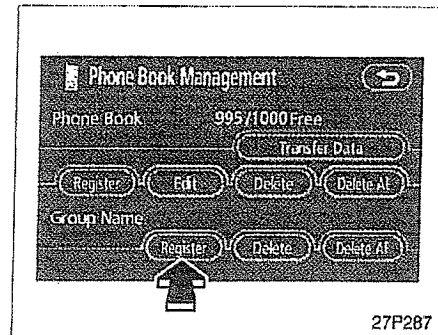

1. Touch the "Register" switch of "Group name".

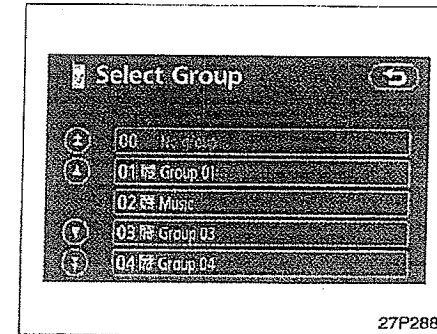

2. Select the group you want to register.

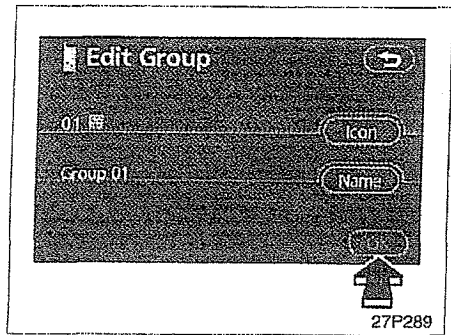

3. When you complete all the edit, touch the "OK" switch.

● Selecting a group icon

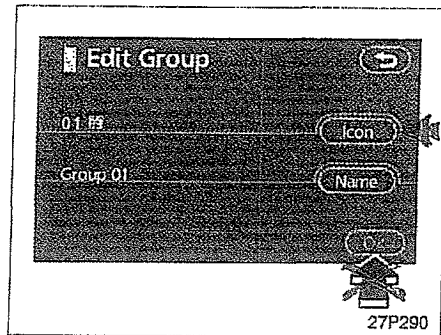

1. Touch the "Icon" switch.

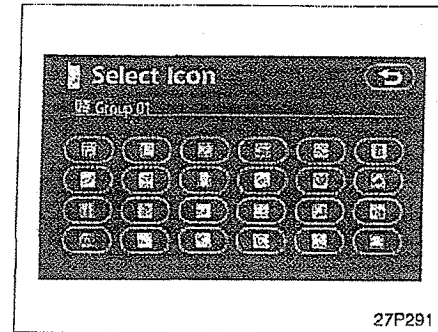

2. Select the desired icon.

• Editing a group name

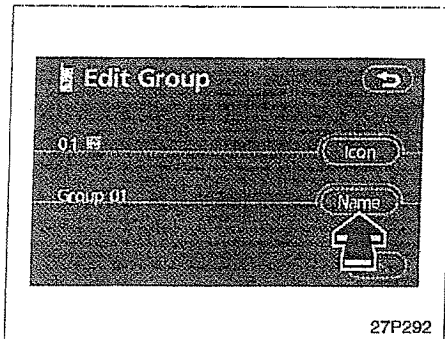

1. Touch the "Name" switch.

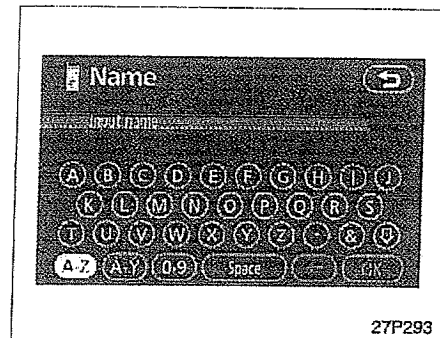

2. Use the software keyboard to input the name.

• Deleting a group name

You can delete the group names individually or all at once. If you delete a group name, that group will return to the default setting. (excluding "No Group")

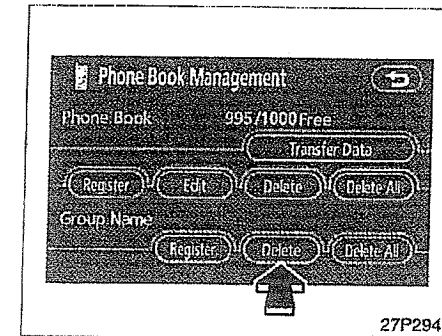

1. Touch the "Delete" switch of "Group Name".

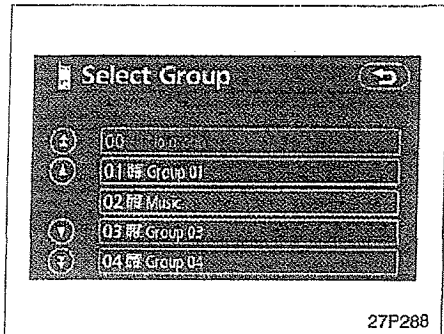

2. Select the group you want to delete the name of.

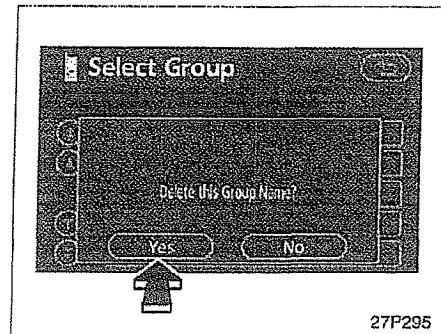

3. Touch the "Yes" switch.

• Deleting all the group names

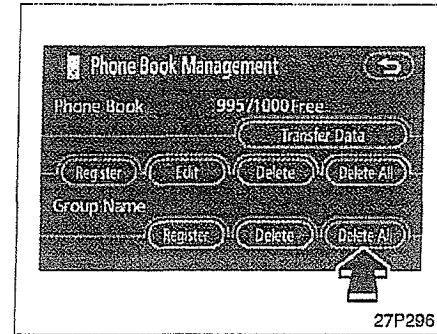

1. Touch the "Delete All" switch of "Group Name".

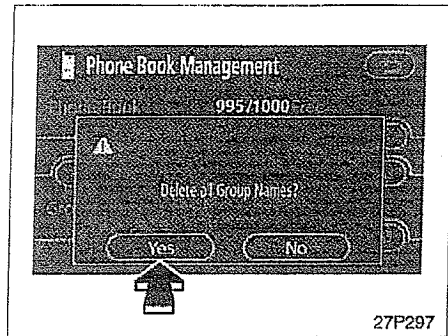

2. Touch the "Yes" switch.

• **Deleting the log data**
 You can delete the log data individually or all at once.
 When you release your vehicle, delete all the data on the system.
 (a) **individually**

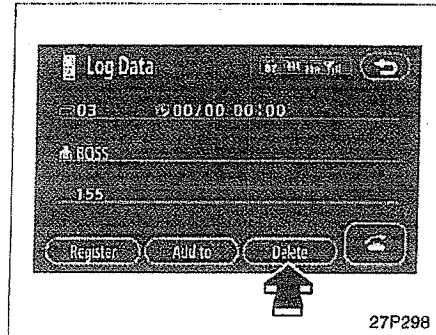

1. Touch the "Delete" switch on the "Log Data" screen.

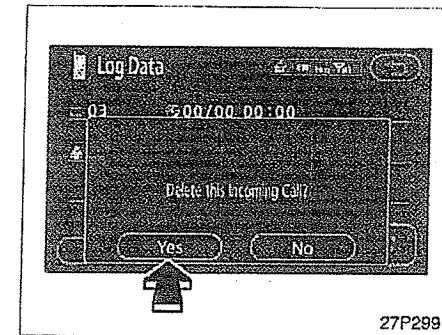

2. Touch the "Yes" switch.

(b) all at once

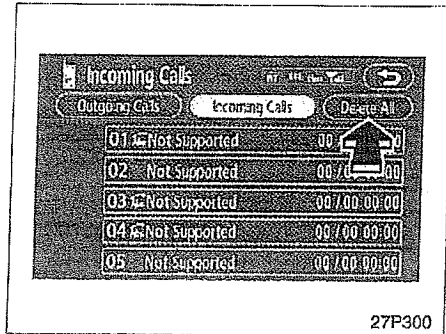

1. Touch the "Delete All" switch on the "Outgoing Calls" or "Incoming Calls" screen.

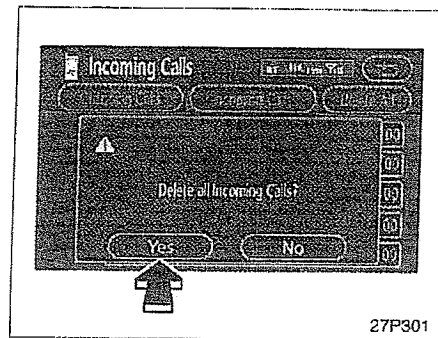

2. Touch the "Yes" switch.

(v) Setting the security

When you set the security, you can prevent people from using some functions of the hands-free system. It is useful when you leave your car with the hotel or you do not want others to see the data you registered.

When you set or unlock the security, you have to input the security code. Be sure to change the default code when you use the security for the first time.

● **Changing the security code**

The security code is 4 digits and the default is "0000".

Choose a new code that is hard for other people to know.

When you change the security code, do not forget the code. The dealers cannot unlock the security when you forget it.

If you forget the security code, initialize your personal data. (See "Initializing the security code" on page 227.)

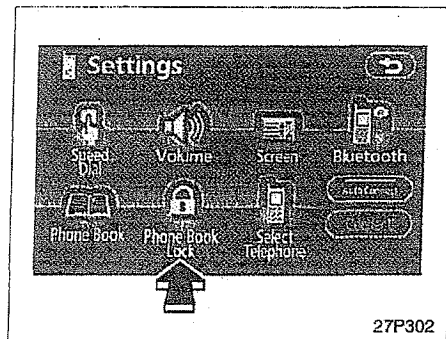

1. Touch the "Phone Book Lock" switch.

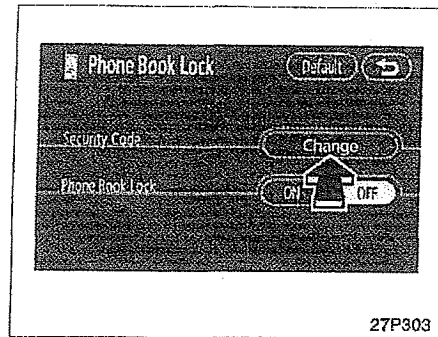

2. Touch the "Change" switch.

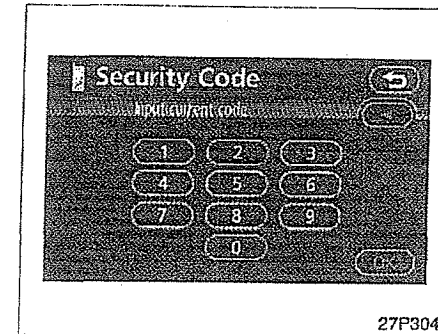

3. Input the security code.

Each time you touch "◀", an inputted digit is deleted.

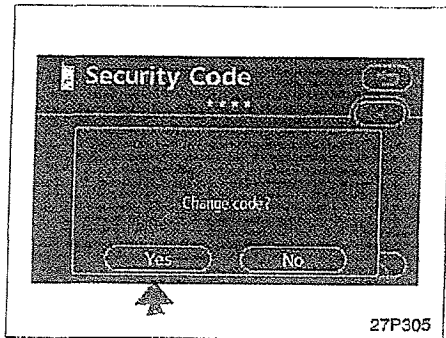

4. Touch the "Yes" switch.

• Phone Book Lock

When you set the phone book lock, you can have the following functions locked.

- Display of the phone book screen and transferring, registering, editing, deleting the phone book data.
- Display of speed dial screen, registering, deleting the speed dial and speed dialing.
- Display of the other party's name for calls being received or made
- Display of dialed numbers screen and received calls screen, deleting dialed numbers and received numbers.
- Display of phone information screen.
- Changing the security code.

When you set this function, the speed dial screen is not displayed while you are driving.

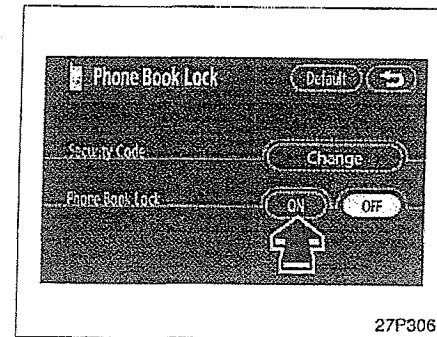

1. Touch the "ON" switch.

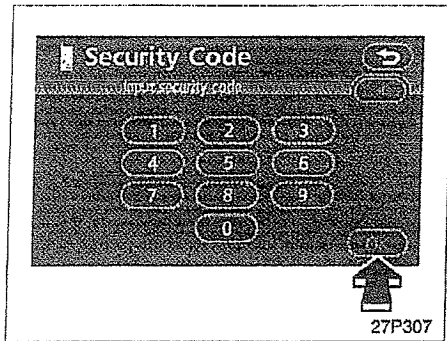

2. Input the security code and touch "OK".

• Initializing the security code
You can initialize the settings.

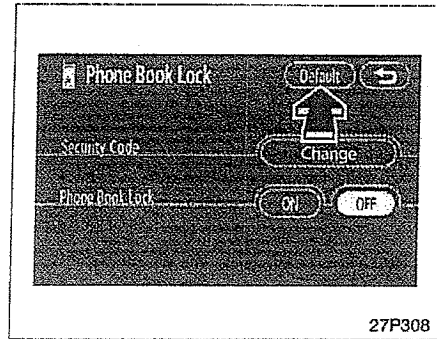

1. Touch the "Default" switch.

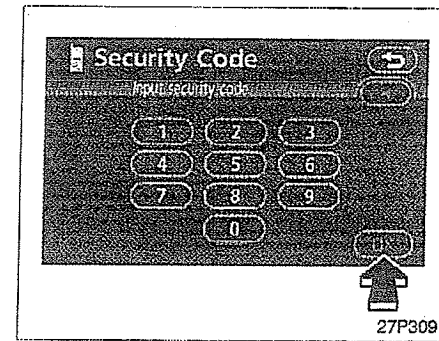

2. Input the security code and touch "OK".

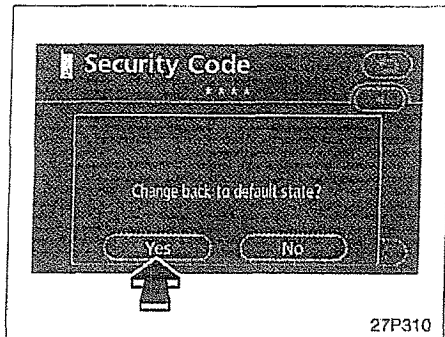

3. Touch the "Yes" switch.

(f) Setting a Bluetooth phone

- Selecting a Bluetooth phone

In case you register more than one Bluetooth phone, you need to choose a favorite one.

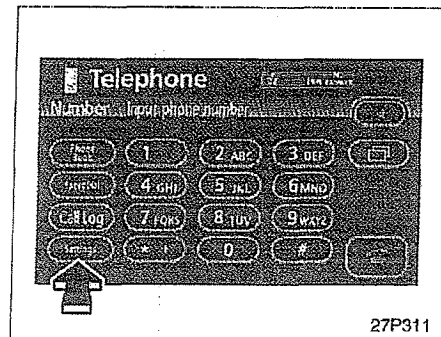

1. Touch the "Settings" switch to display "Settings" screen.

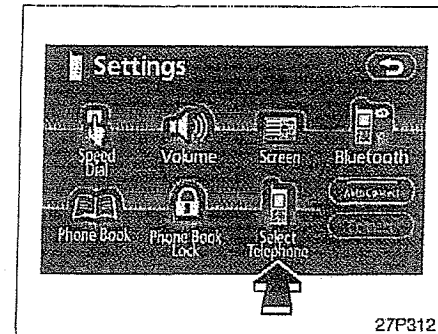

2. Touch the "Select Telephone" switch to display "Select Telephone" screen. You can select the Bluetooth phone from a maximum of 6 numbers.

"Empty" is displayed when you have not registered a Bluetooth phone yet.

Bluetooth mark is displayed when you choose the phone.

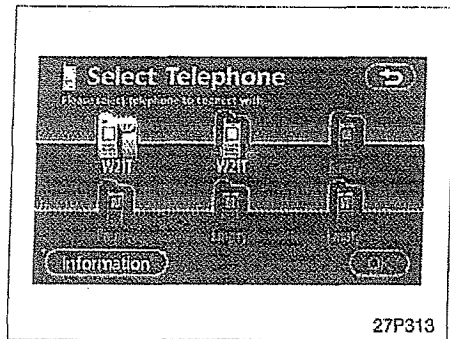

Although you can register up to 6 Bluetooth phones in the system, only one Bluetooth phone can function at a time.

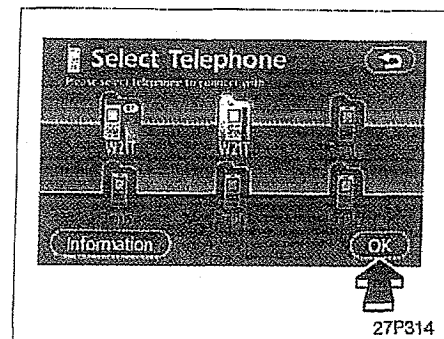

3. Touch the "OK" switch.

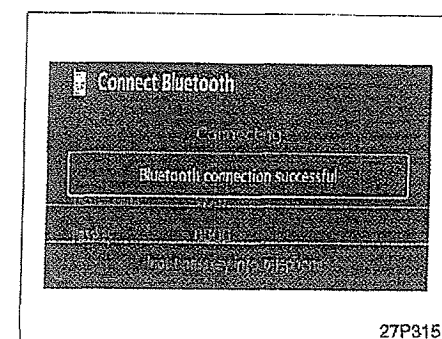

When the result message is displayed, you can use the Bluetooth phone.

When another Bluetooth phone is trying to connect, this screen is displayed.

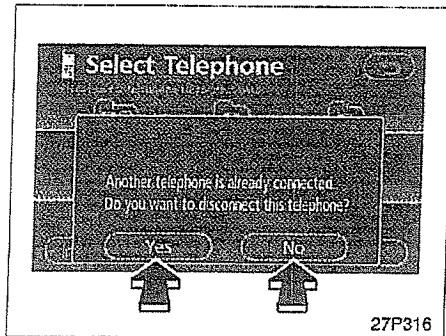

Touch the "Yes" or "No" switch.

• Displaying Bluetooth information

You can see or set the information of the Bluetooth phone on the system.

Device Name ... the name of the Bluetooth phone which is displayed on the screen. You can change it into a desired name.

Bluetooth Device Address ... the address peculiar to the system. You cannot change it.

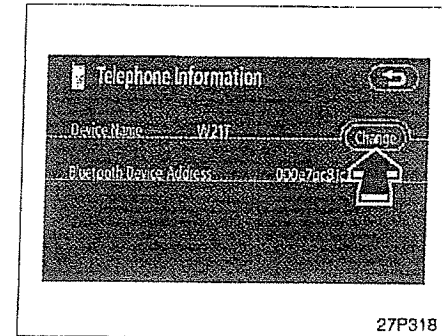

2. Touch the "Change" switch.

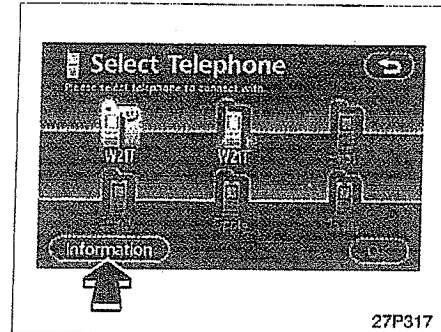

1. Select the desired phone and touch the "Information" switch.

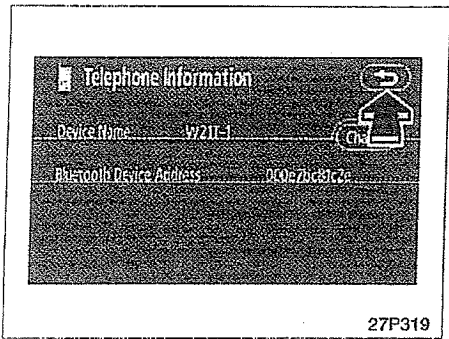

3. When you complete the setting, touch “”.

● Changing a Device Name

You can change a device name. If you change a device name, the name registered in your cellular phone is not changed.

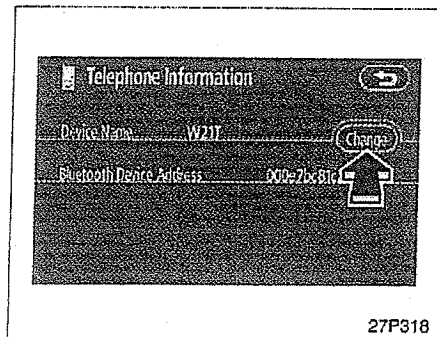

1. Touch the “Change” switch.

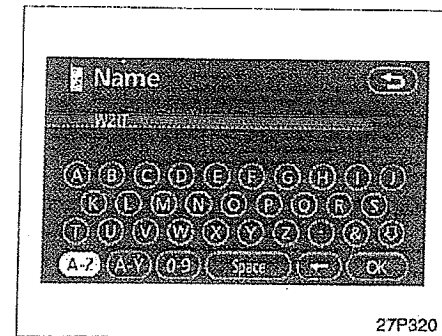

2. Use the software keyboard to input the device name.

• **Changing the Bluetooth settings**

You can change the display and settings of Bluetooth information on the system.

The information displays the following items.

Device Name ... the name in the Bluetooth network. You can change it.

Passkey ... the password when you register your cellular phone in the system. You can change it into the figure of 4-8 digits.

Bluetooth Device Address ... the address peculiar to the system. You can not change it. If you have registered two Bluetooth phones with the same Device Name or Passkey and you cannot distinguish one from the other, refer to it.

When you change the device name or Passkey, do the following.

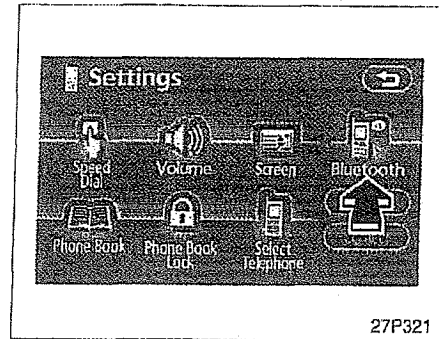

1. Touch the "Bluetooth" switch.

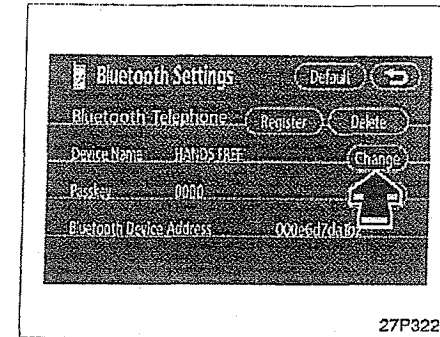

2. Touch the "Change" of "Device Name" or "Passkey".

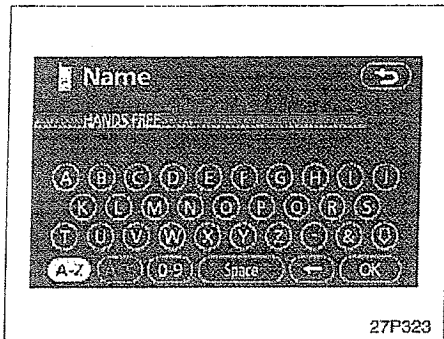

3. Use the software keyboard to input the device name.
You can input up to 20 characters.

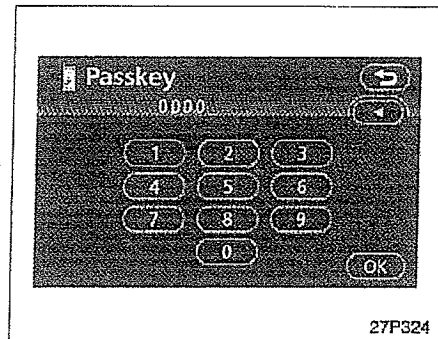

4. Input a Passkey with 4 - 8 digits.
When you touch "◀", the inputted digit is deleted.

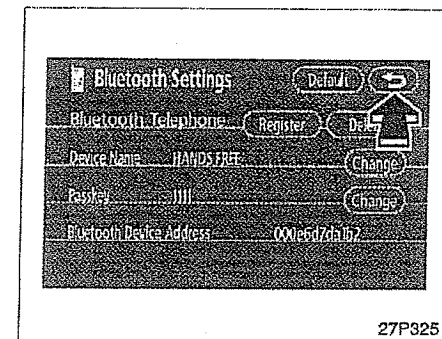

5. When you complete the setting, touch "⏪".

⦿ **Initializing the Bluetooth settings.**

You can initialize the settings.

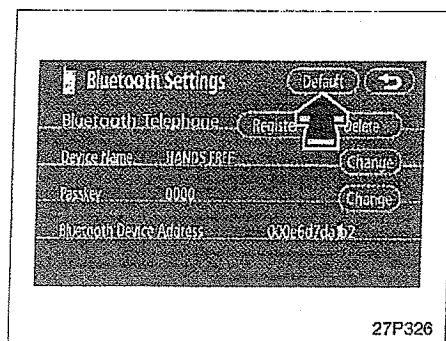

27P326

1. Touch the "Default" switch.

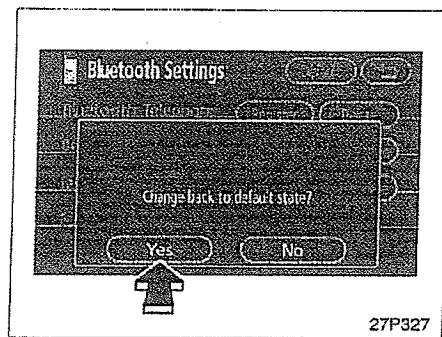

27P327

2. Touch the "Yes" switch.

⦿ **Deleting a Bluetooth phone**

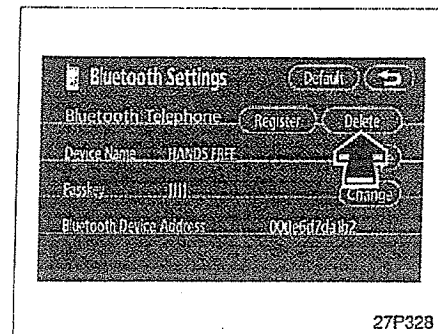

27P328

1. Touch the "Delete" switch of "Bluetooth Telephone".

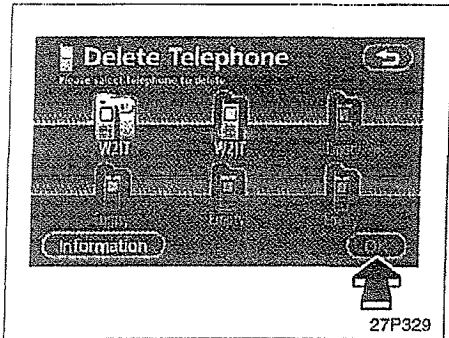

2. Select the telephone you want to delete and touch "OK".

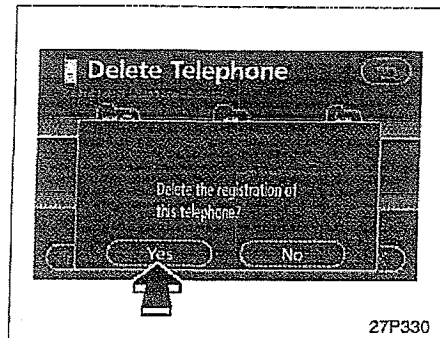

3. Touch the "Yes" switch.

When you delete the telephone while another Bluetooth phone is connected, this message is displayed.

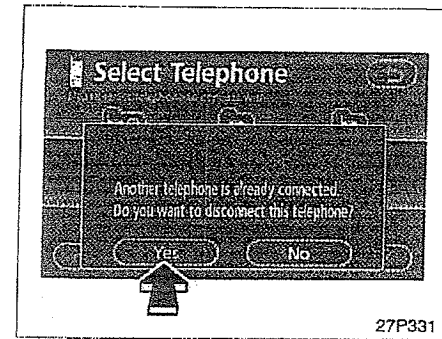

Touch the "Yes" switch.

Ⓞ **Displaying the information of the Bluetooth phone you delete**

You can display the information of the Bluetooth phone before you delete it and you can make sure whether the telephone you delete is correct or not.

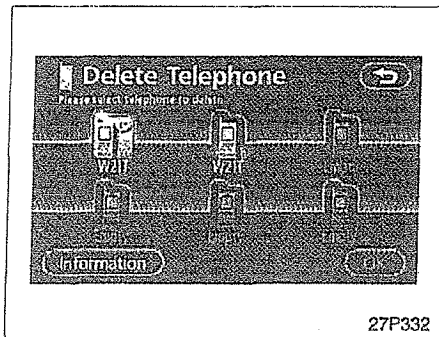

1. Select the telephone you want to display the information about.

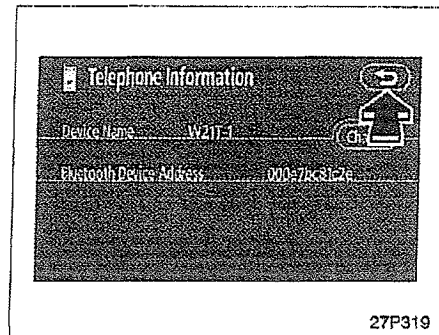

2. When you complete confirming it, touch "Ⓞ".

—**Speech command system**

The speech command system enables you to operate the hands-free system by giving a command.

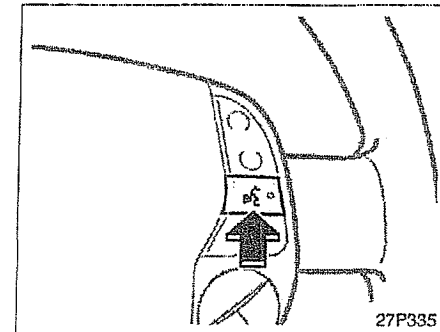

1. Push the speech command switch.

A beep sounds and on-screen message is displayed with an indicator at the top left.

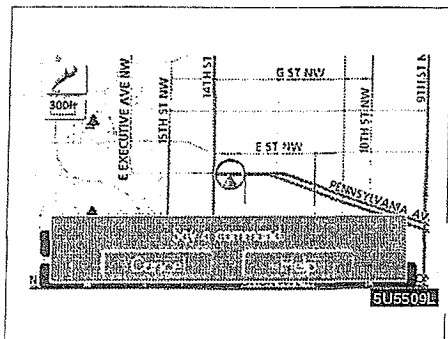

2. Give a command while an indicator is shown in the display. If you want to check the command list, touch the "Help" switch to display the Help screen. (See "Help screen" on page 238.) When you touch the "Cancel", the previous screen returns.

If the hands-free system does not respond or the confirmation screen does not disappear, push the speech command switch and try again.

If no command is given, a beep sounds and the indicator disappears 6 seconds later.

If the system does not recognize your speech, the system will respond with this message ("System does not recognize this command, rephrase your command."). Start the operation from the beginning.

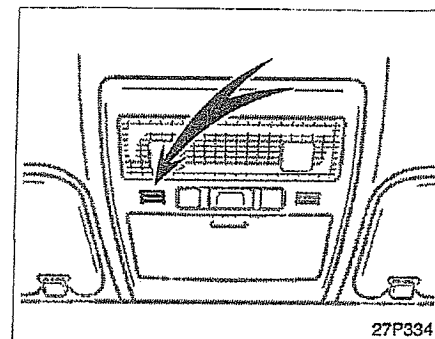

► Microphone

It is unnecessary to speak directly into the microphone when giving a command.