

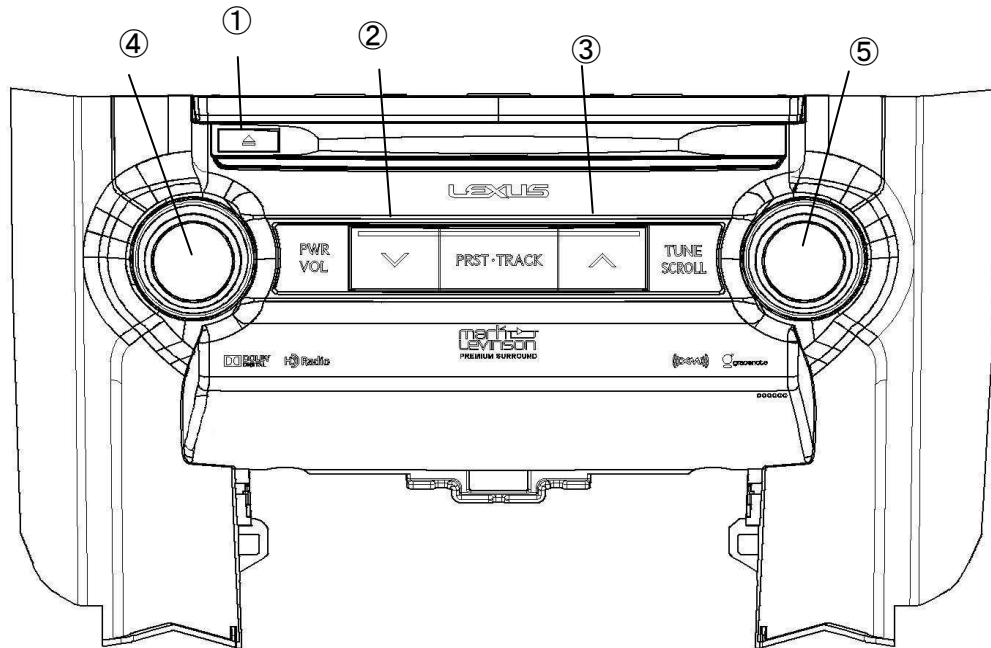

FT0043A User manual

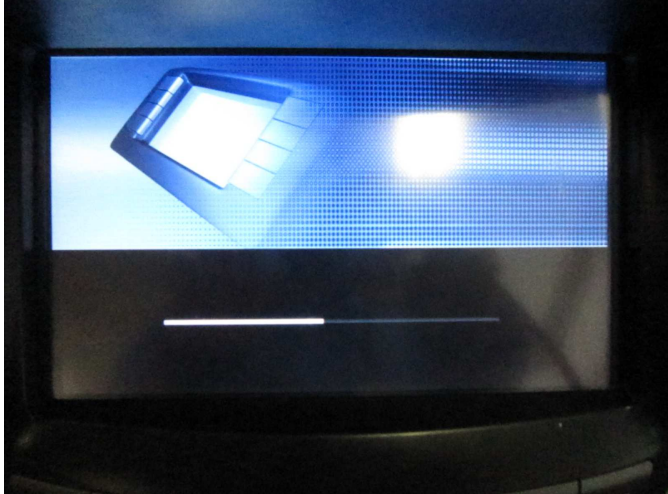

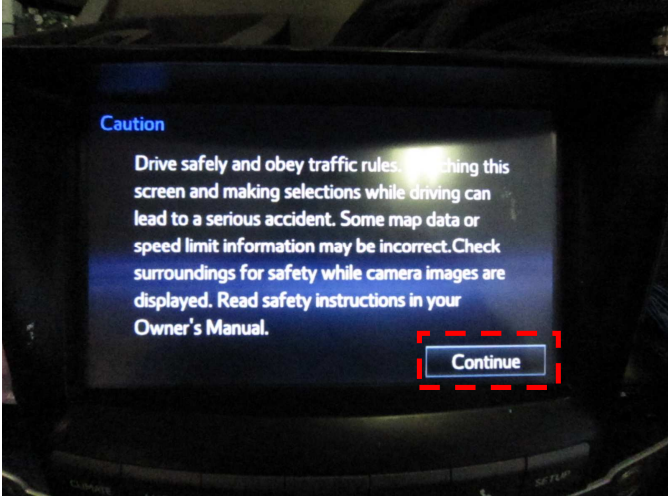

①	DISC Eject
②	SEEK/TRACK DOWN
③	SEEK/TRACK UP
④	Push : Audio ON/OFF
	Turn right : VOL UP Turn left : VOL DOWN
⑤	Turn right : TUNE/TRACK UP
	Turn left : TUNE/TRACK DOWN

FT0043A Bluetooth Operation

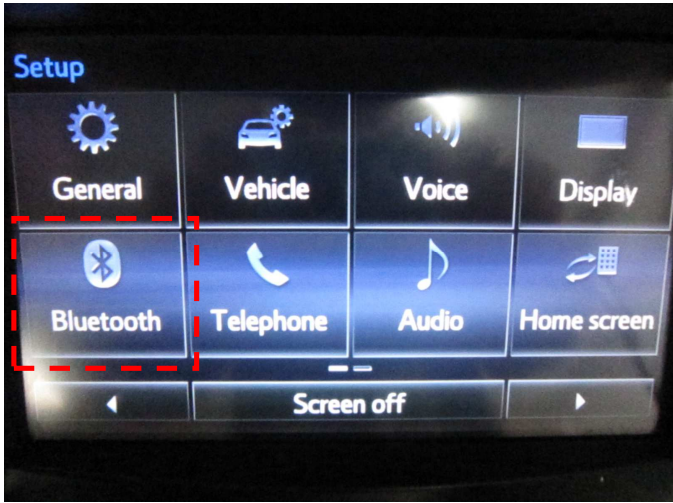
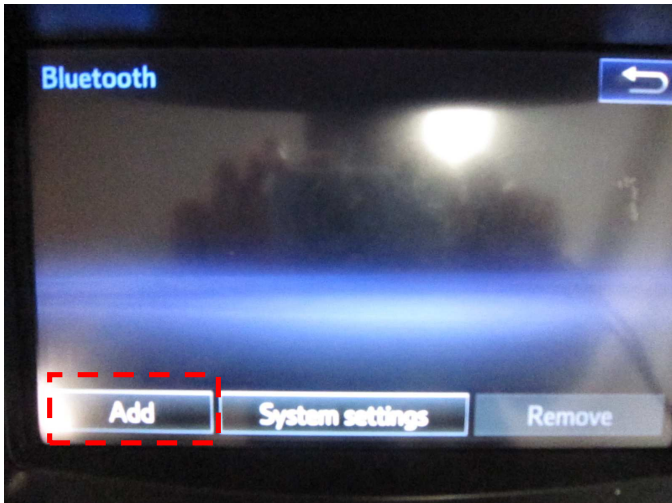
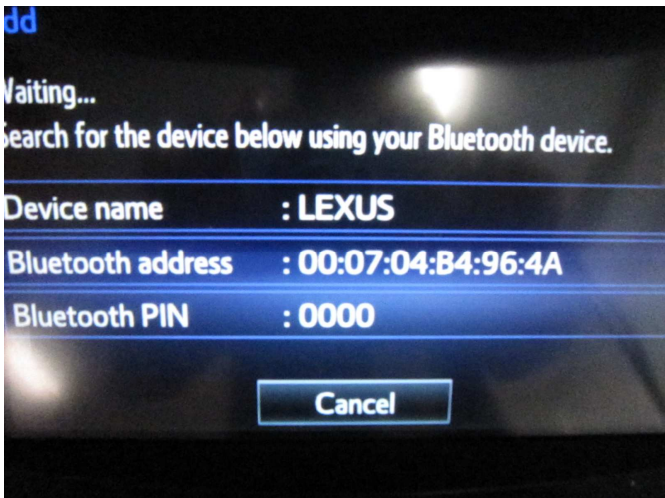
1		After Power tuened up , H/U starts loading.
2		Please touch the 「Continue」.
3		Pless the 「SETUP」 by Display Hard Switch. ※SETUP can not serect by the touch SW.

4		Please touch the 「Bluetooth」.
5		Please touch the 「Add」.
6		The search of the device is started.

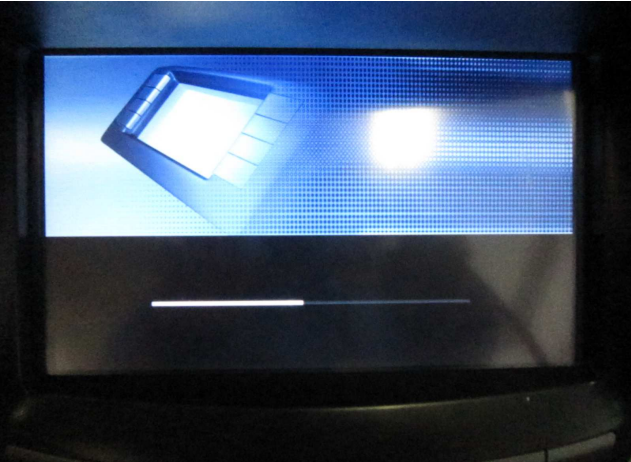
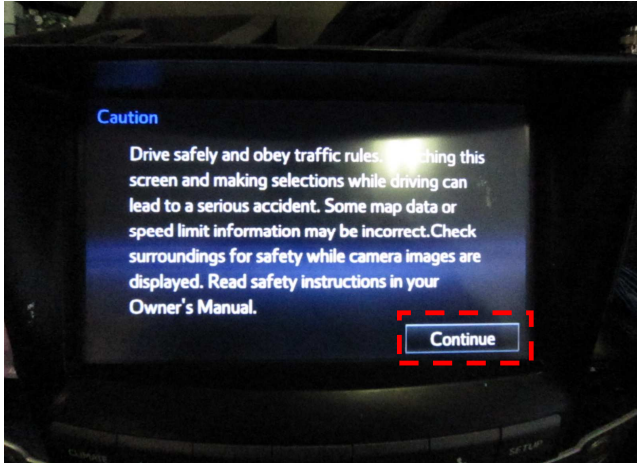
FT0043A Wi-Fi Operation

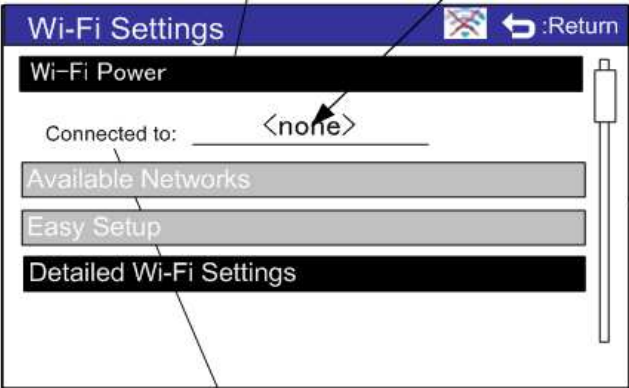
<p>1</p>		<p>After Power tuened up , H/U starts loading.</p>
<p>2</p>		<p>Please touch the 「Continue」.</p>
<p>3</p>		<p>Pless the 「SETUP」 by Display Hard Switch. ※SETUP can not serect by the touch SW.</p>
<p>4</p>		<p>Please touch the 「Wi-Fi Power」.</p>

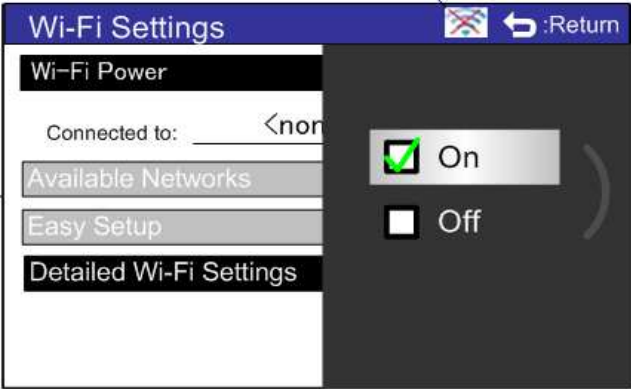
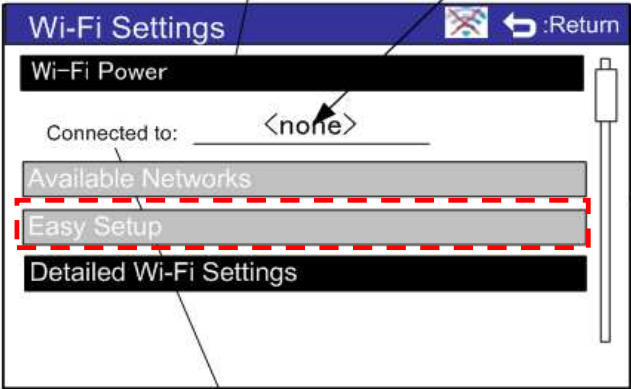
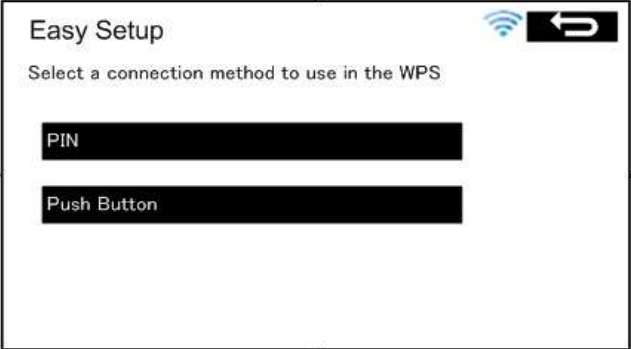
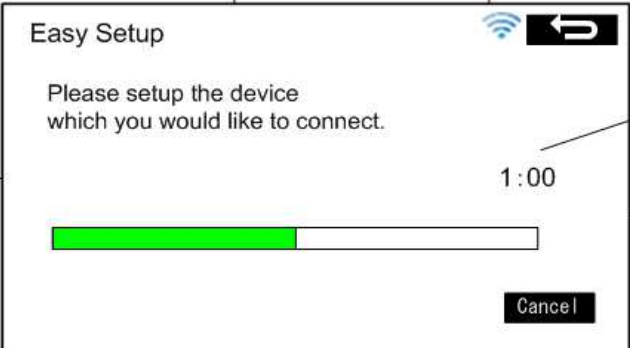
5		Please touch the 「ON」.
6		Please touch the 「Easy Setup」.
7		Please touch the 「Push Button」.
8		The search of the device is started.

■ Certification

> For vehicles sold in the U.S.A.

FCC ID: BABFT0043A

CAUTION: Radio Frequency Radiation Exposure

This equipment complies with FCC radiation exposure limits set forth for an uncontrolled environment and meets the FCC radio frequency (RF) Exposure Guidelines in Supplement C to OET65. This equipment should be installed and operated keeping the radiator at least 20cm or more away from person's body (excluding extremities: hands, wrists, feet and ankles).

This device complies with part 15 of the FCC Rules. Operation is subject to the following two conditions: (1) This device may not cause harmful interference, and (2) this device must accept any interference received, including interference that may cause undesired operation.

FCC WARNING

Changes or modifications not expressly approved by the party responsible for compliance could void the user's authority to operate the equipment.

> For vehicles sold in Canada

•IC: 2024B-FT0043A

This device complies with Industry Canada licence-exempt RSS standard(s). Operation is subject to the following two conditions: (1) this device may not cause interference, and (2) this device must accept any interference, including interference that may cause undesired operation of the device.

Le présent appareil est conforme aux CNR d'Industrie Canada applicables aux appareils radio exempts de licence. L'exploitation est autorisée aux deux conditions suivantes : (1) l'appareil ne doit pas produire de brouillage, et (2) l'utilisateur de l'appareil doit accepter tout brouillage radioélectrique subi, même si le brouillage est susceptible d'en compromettre le fonctionnement.

CAUTION: Radio Frequency Radiation Exposure

This equipment complies with IC radiation exposure limits set forth for an uncontrolled environment and meets RSS-102 of the IC radio frequency (RF) Exposure rules. This equipment should be installed and operated keeping the radiator at least 20cm or more away from person's body (excluding extremities: hands, wrists, feet and ankles).

ATTENTION: l'exposition aux rayonnements radiofréquence

- Cet équipement est conforme aux limites d'exposition aux rayonnements énoncées pour un environnement non contrôlé et respecte les règles d'exposition aux fréquences radioélectriques (RF) CNR-102 de l'IC. Cet équipement doit être installé et utilisé en gardant une distance de 20 cm ou plus entre le dispositif rayonnant et le corps (à l'exception des extrémités : mains, poignets, pieds et chevilles).