

TORQUE HORSE

Forward/Reverse Left/Right Steering



NO.8888A

Assembly Contains

To protect components from damaging, they may be packed in the styrofoam tray out of plain sight. Please search styrofoam tray and remove all of the components listed below.

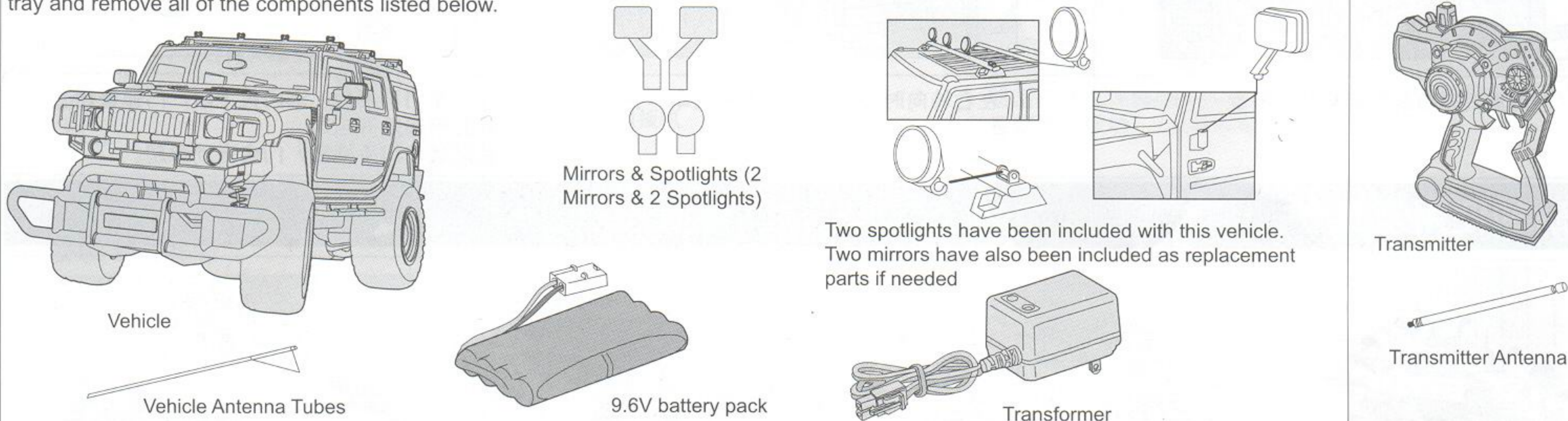

Name Of The Parts And Installing Method Of Vehicle

Name Of The Parts

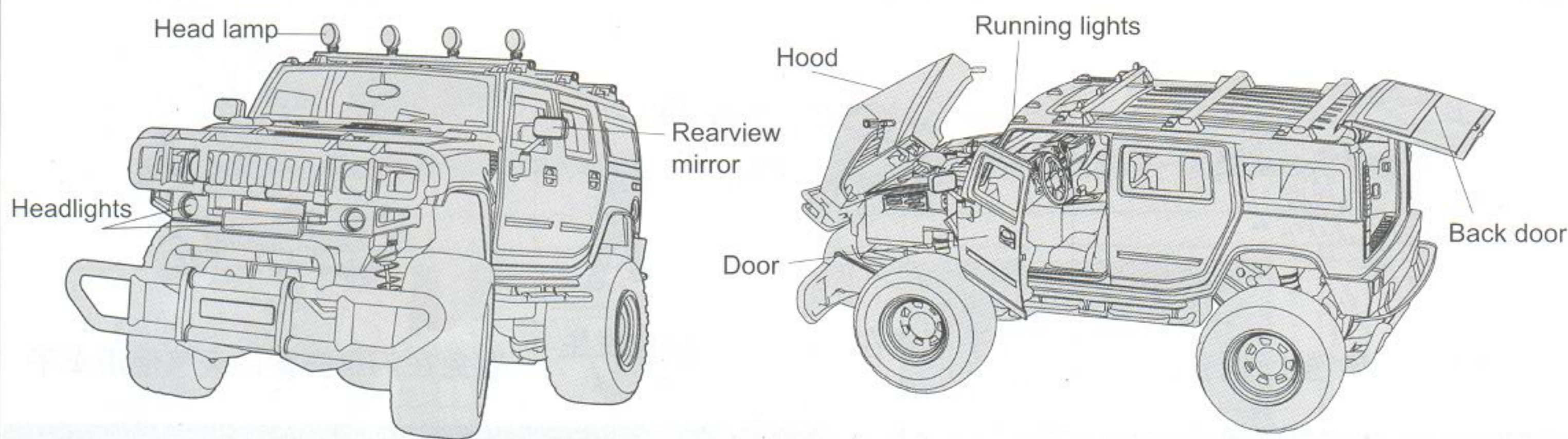

Installing vehicle antenna

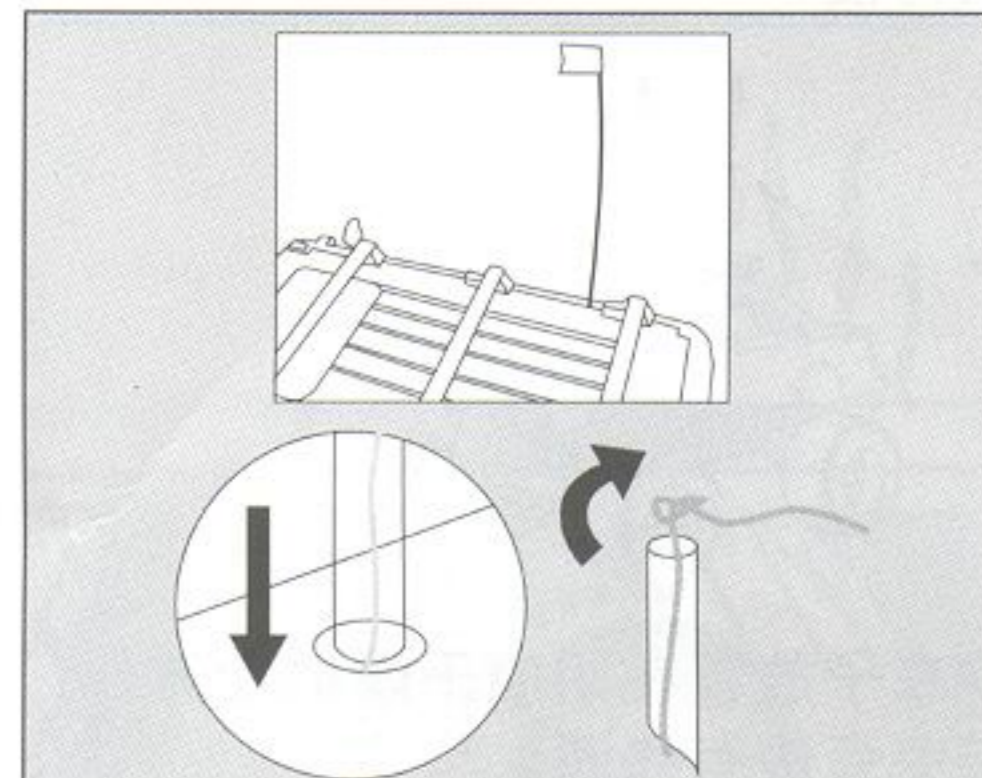

1. Locate the vehicle antenna wire which leads through an opening in the top of the vehicle.
2. Slide the vehicle antenna wire through the Vehicle Antenna Tube. The tube will fit inside the opening.
3. Tie a simple knot in the antenna wire to hold the Vehicle Antenna Tube in place.

Installing Vehicle Battery Pack

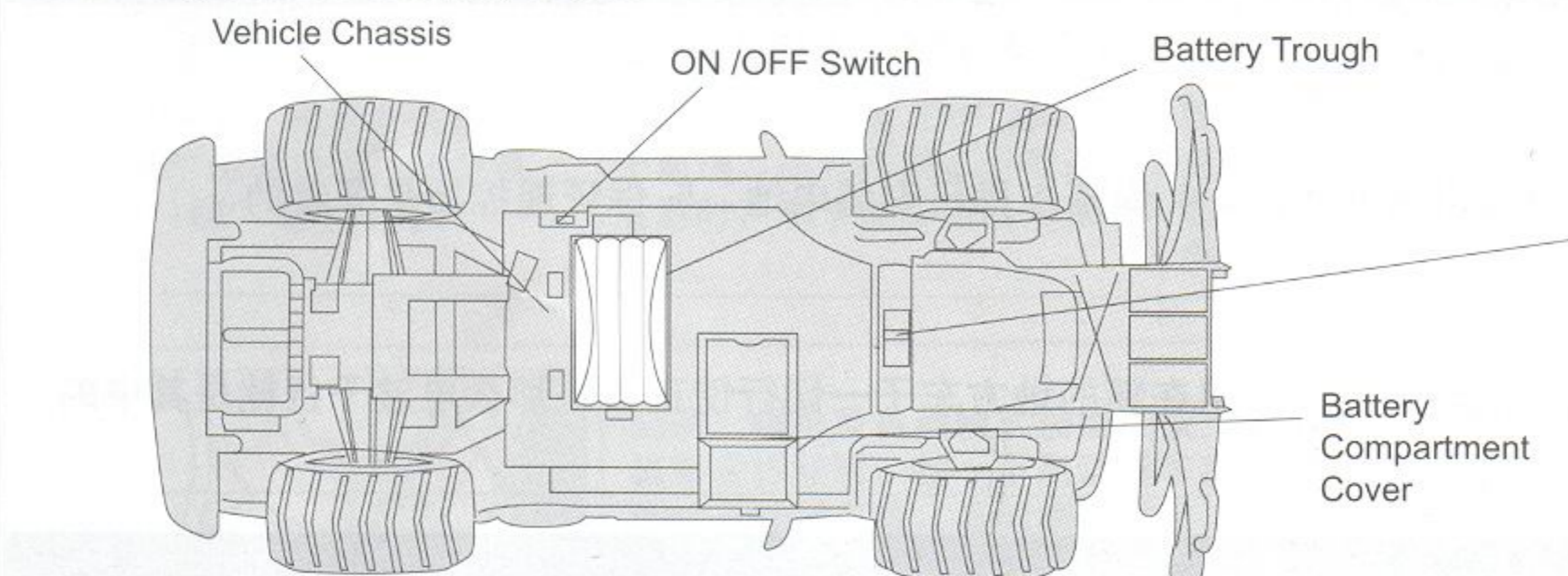

1. Carefully turn the vehicle over and locate the battery compartment which is on the bottom of the vehicle chassis.(see attached drawing)
2. Undo the screw. Remove battery compartment cover.
3. Connect charged battery with vehicle and put the battery into vehicle.(see attached drawing)
4. Replace the battery compartment cover and rotate the battery compartment lock so that it is in the locked position.

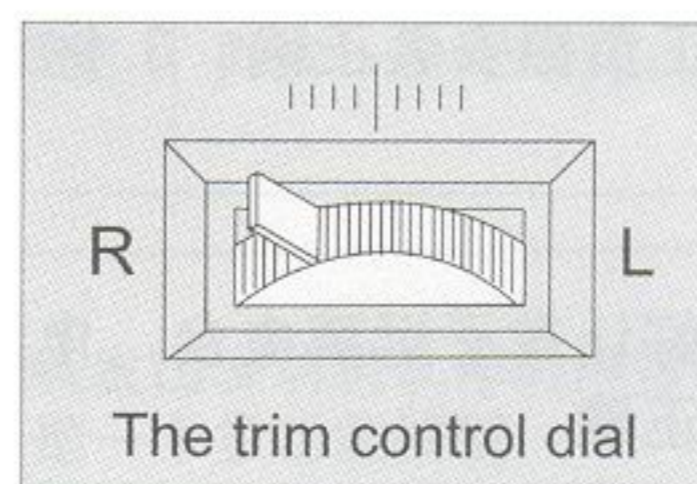

The Trim Control Dial is located between the front wheels. If the vehicle begins to pull to the left adjust the trim control towards the "R" marking. If the vehicle pulls to the right while driving adjust the trim control towards the "L" marking.

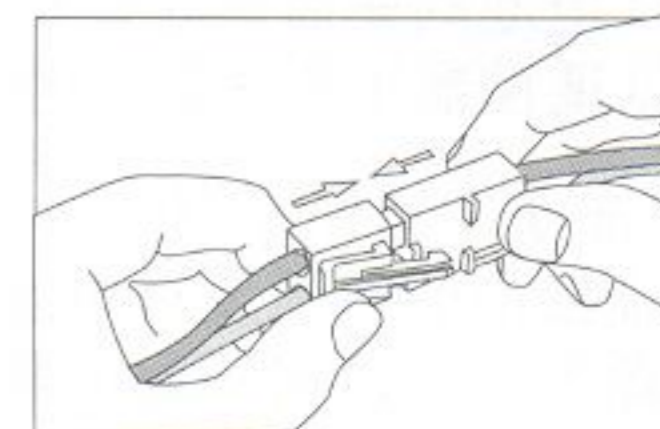







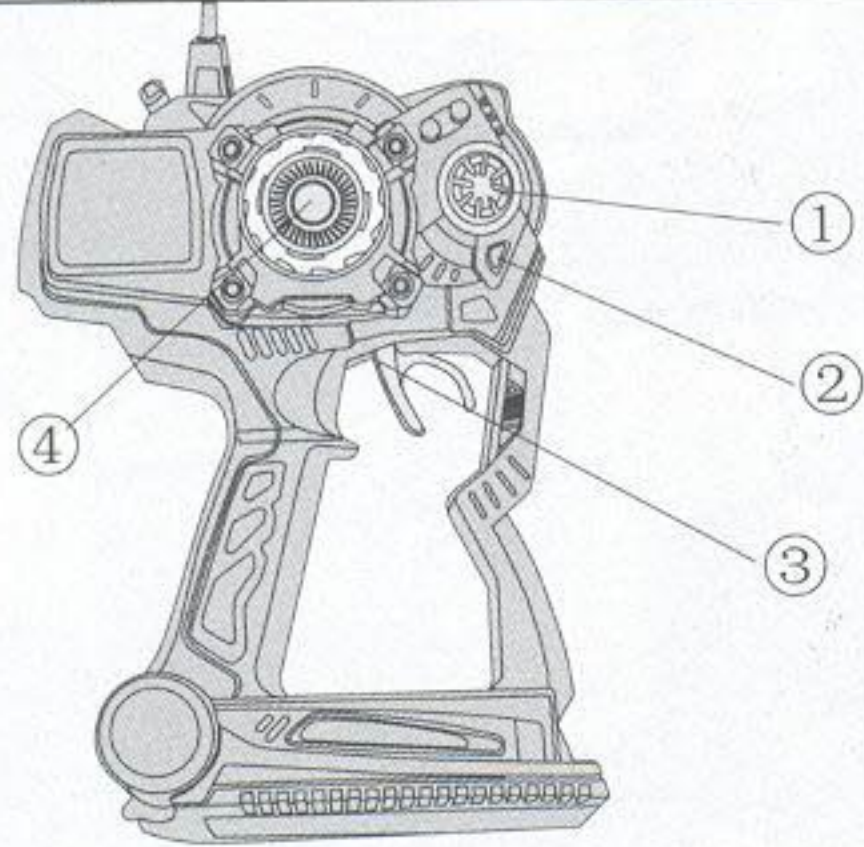
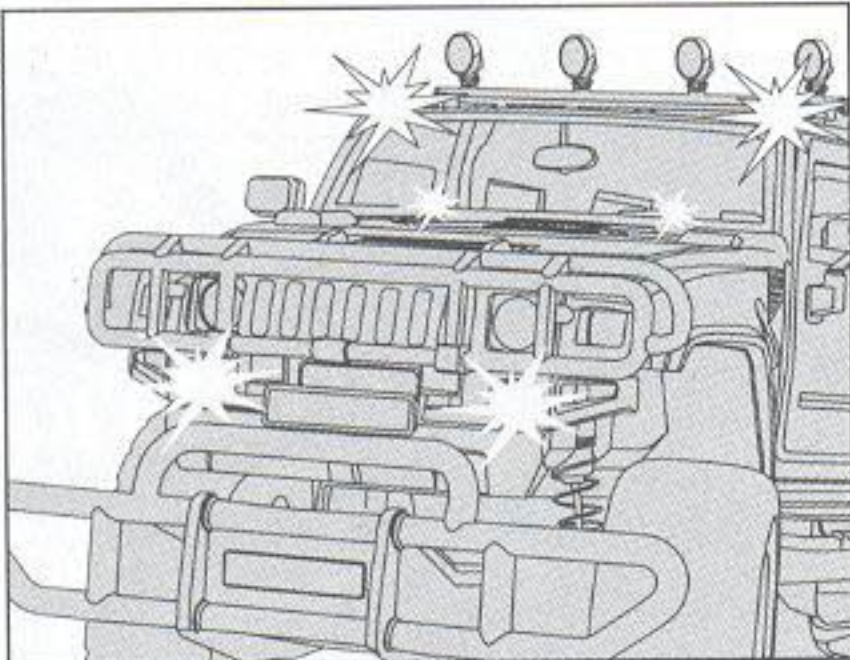
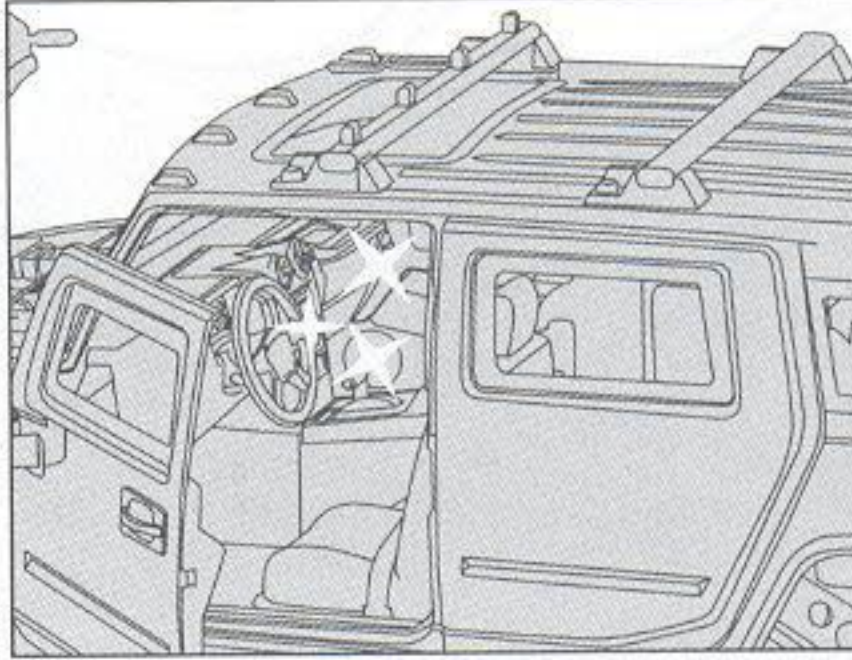
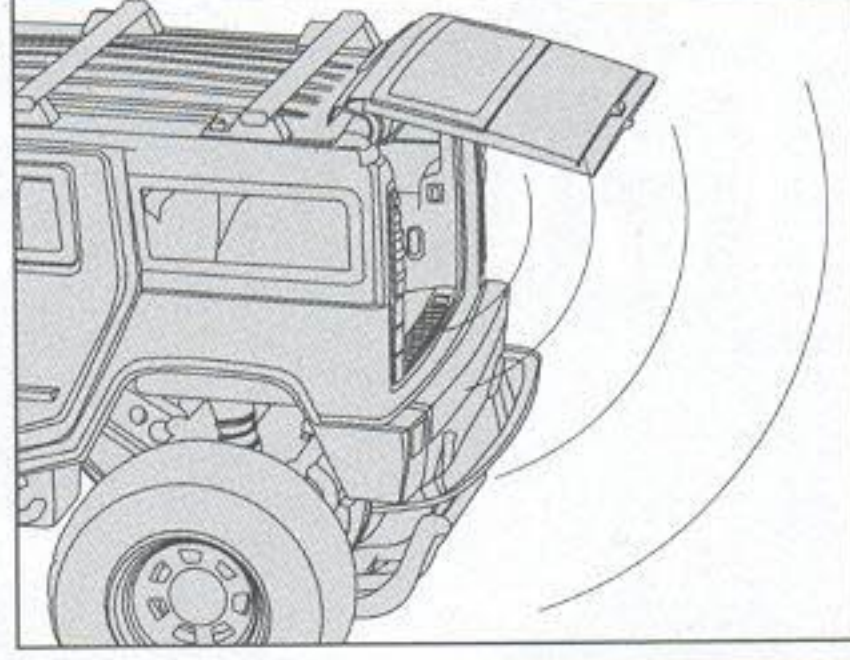
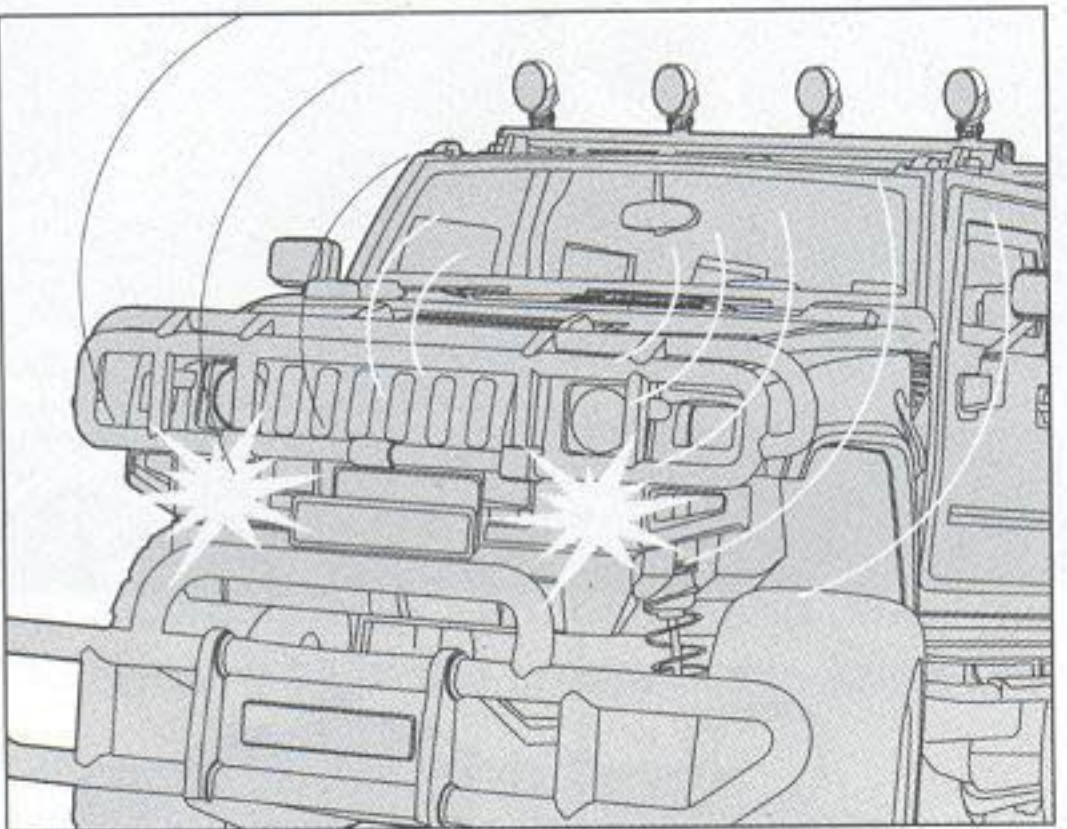
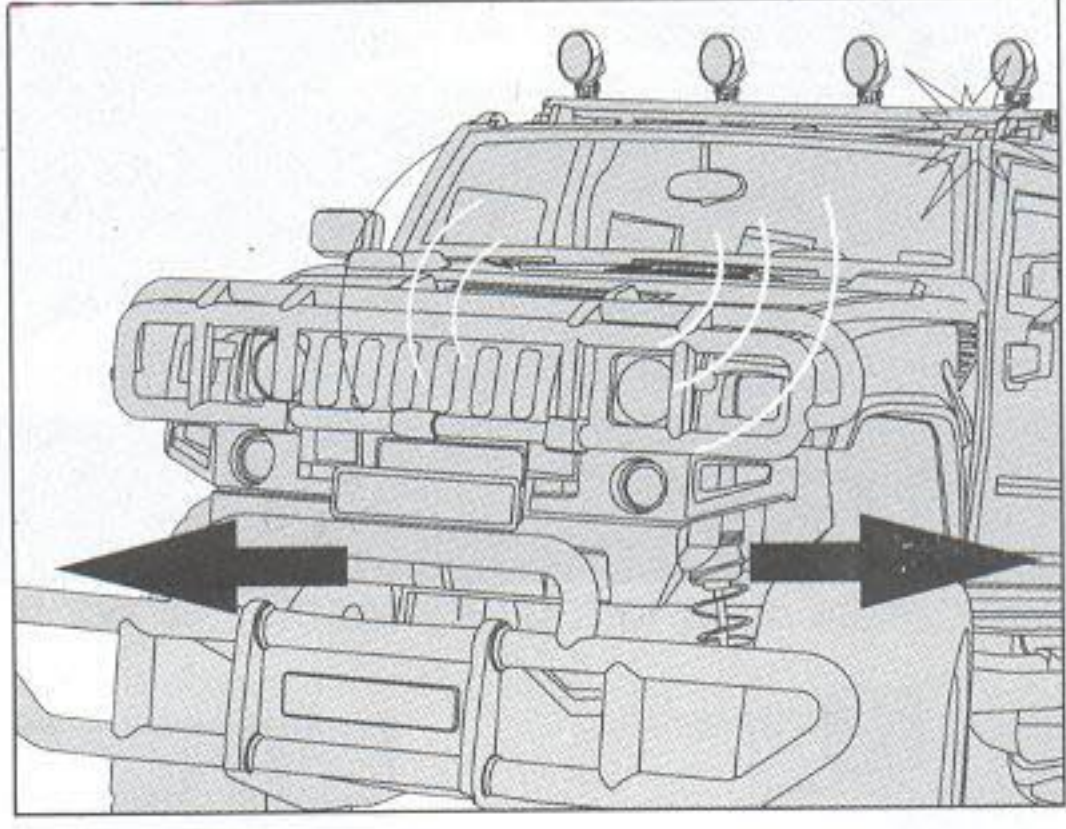
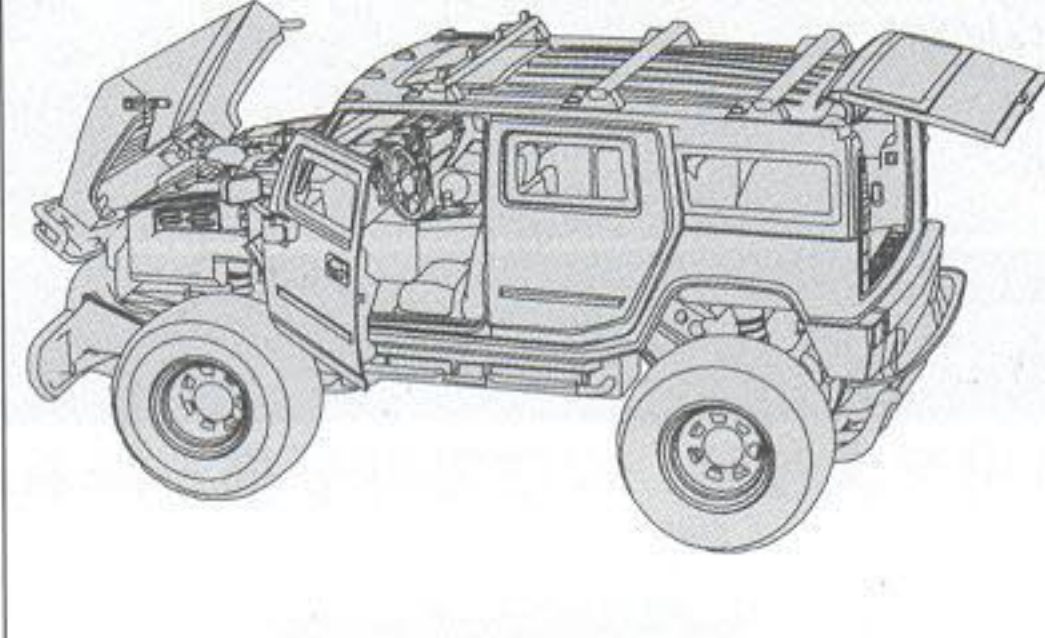

Caution: connect firmly.
(The bad connect will affect the car operation.)

Operation Method And Function Of Vehicle

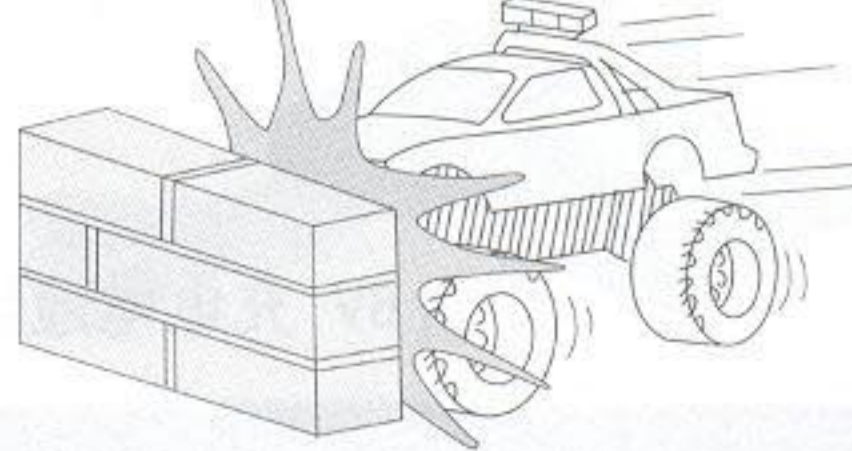
To install the 9.6V rechargeable battery pack, turn on the power switch of the car, then the indicator light of the instrument set shines and the horn sounds at the same time, the car is awaiting orders.

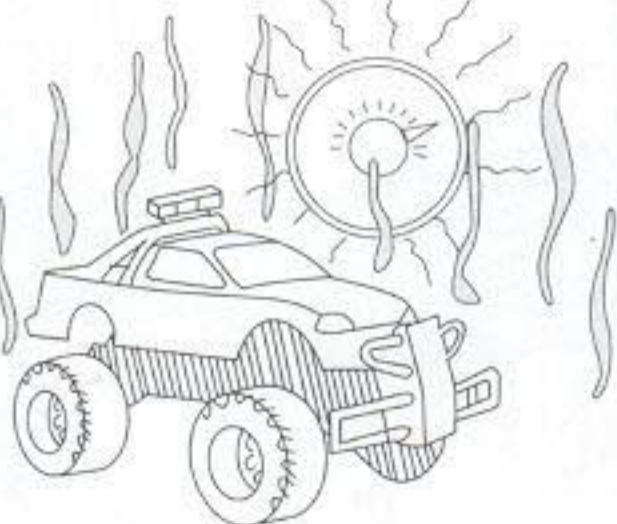
	<p>②</p>  <p>Working headlight, lights, tail lights.</p>	<p>②</p>  <p>Working interior lights</p>	<p>③</p>  <p>Real brake sound & reverse control</p>
<p>③</p>  <p>Real speed sound & horn sound.</p>	<p>④</p>  <p>Real slowdown sound when turning left / right.</p>	<p>Manual</p>  <p>The car door can be opened. The spring locks when closing the door. The hood opens while lifting. The rear door opens automatically when pulling the handle.</p>	

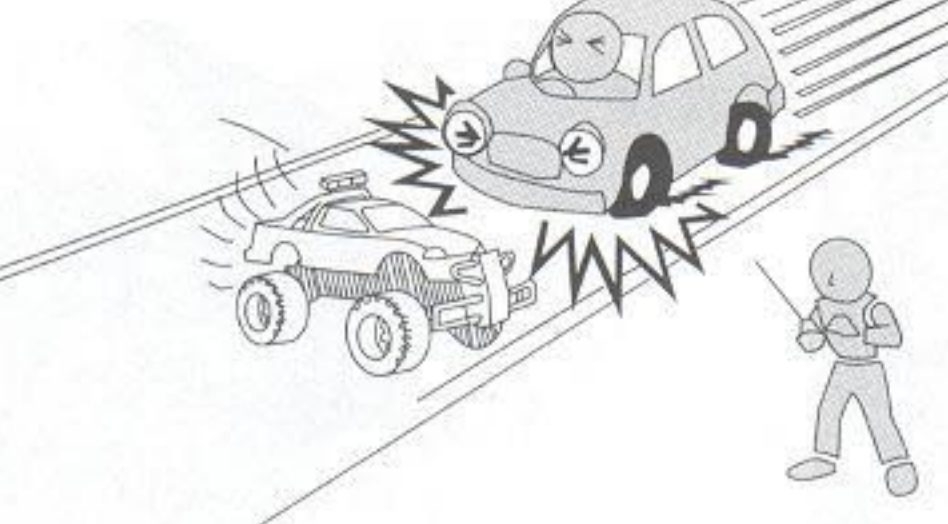
Proper Use and Precautions

 <p>Avoid water puddles, wet grass or rain.</p>	 <p>Avoid sand, mud and salt.</p>	 <p>Avoid collisions with hard surfaces.</p>	 <p>Do not leave vehicle in direct sunlight for long periods as damage may occur.</p>
 <p>Store vehicle in cool dry place and away from direct heat sources.</p>	 <p>Avoid running on thick pile carpeting.</p>	 <p>Do not play the vehicle on the roads to avoid accident.</p>	 <p>Do not play the vehicle in lightning & thunder condition.</p>

Trouble Shooting and Support

90% of all difficulties experienced with radio controlled vehicles are due to either weak batteries or batteries that have been installed incorrectly. When batteries become weak, the vehicle may not necessarily stop completely but may exhibit slow response, slow or erratic behaviour.

Problem- Vehicle does not move or moves slowly.

1. Make certain the fresh alkaline batteries have been installed in the correct position. 2. Make certain the plug (+) and minus (-) markings on battery pack should be in the same position as the plug (+) minus (-) markings in the battery compartment. 3. Make certain that the rechargeable Battery Pack has been fully charged. 4. Make certain that the battery pack has been installed in the vehicle. 5. Make certain that the transmitter is on. 6. Make certain that the controller is not in the lock mode. There should be sound emanating from the vehicle when the transmitter is in drive mode.

Problem- Vehicle moves sporadically by itself.

1. Make certain there is no outside radio interference in your area. Keep the vehicle away from radio towers, electrical lines or tall buildings. If the vehicle operates correctly in the new area, radio interference was the problem. 2. Make certain that the Transmitter Antenna is securely attached to the transmitter.

Caution

- Do not recharge Battery Pack if it is warm to be touched. Allow Battery Pack to cool before recharging. Recharging a warm Battery Pack will shorten the life of the battery pack. Do not charge the damaged battery.
- Remove the battery when not in use.
- Do not dispose batteries in fire; or explosion may occur.
- Dispose of NiMH Battery Pack properly.
- Do not use Battery Charger for any use other than instructed in this booklet.
- Recharging batteries should be done by an adult.
- The bad batteries will cause quality problem of the car.

Charging Battery Pack

IMPORTANT!

The battery pack is not charged before shipping and must be charged when first using. Pay attention to the connection between charger & battery. Be careful when inserting the charger into the socket.

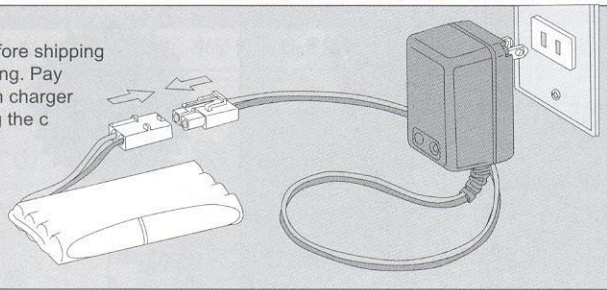

CAUTION:
Connect firmly.

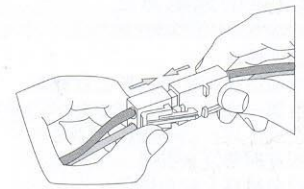

1. Plug the transformer into a standard household 110/120V electrical outlet.

2. the indicator light shines when charging the battery pack should be charged for 4 hours.

NOTE: Battery Packs will become warm after charging or during use. Make certain to allow the Battery Pack to cool before recharging. Charging a warm Battery Pack will greatly reduce its life. The Battery Pack, Charging Cradle and Transformer should be periodically examined so as to avoid wearing out or damaging.

Name Of The Parts And Installing Method, Function Of Transmitter

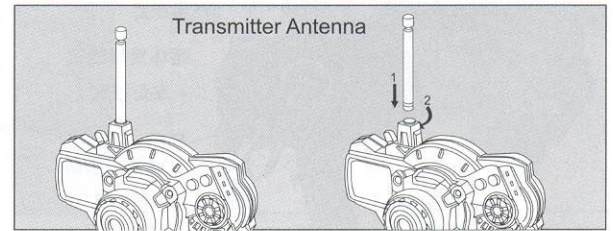
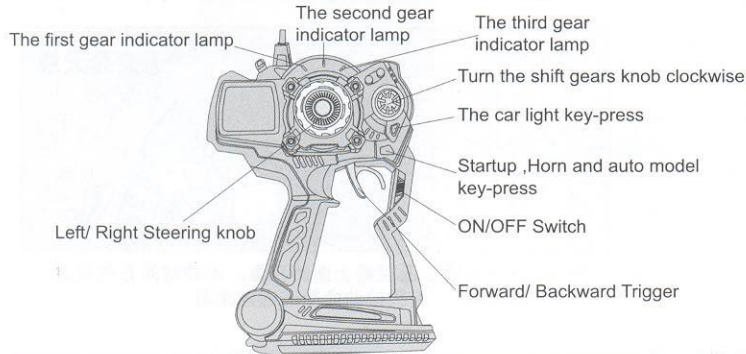

1. Locate the transmitter antenna mount on the top of the transmitter, and turn clockwise until it is tightened. (the loose antenna will affect the control distance.)

Installing Transmitter Battery

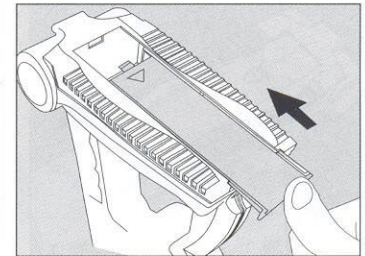
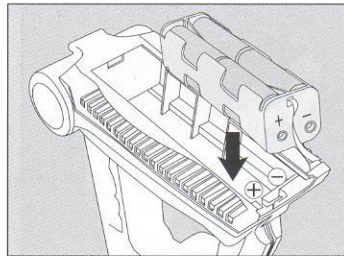
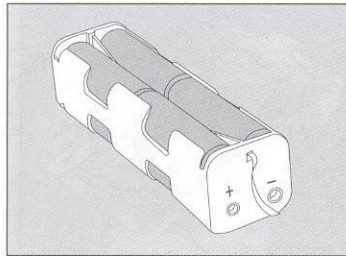
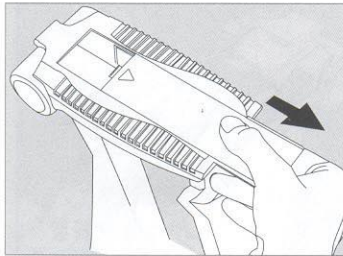

1. Locate the battery compartment which is on the base of the transmitter.

2. Move the battery compartment lock towards the battery compartment and remove the battery compartment cover.

3. Insert 8"AA" size alkaline batteries. make certain the plus (+) and minus (-) markings on the batteries are in the same position as the plus (+) minus (-) marking inside the battery compartment.

4. Replace battery compartment cover making certain that the battery compartment lock has "snapped" into the locked position.

Note: When replacing transmitter batteries, use only alkaline batteries. Do not mix old and new batteries. Do not mix disposable batteries with rechargeable batteries.

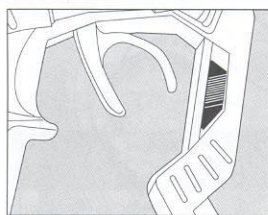

The indicator light of first gear of the transmitter shines when the power switch is turned-on.

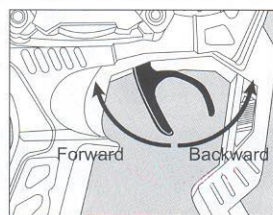

Forward / Trigger: Pull the trigger inside, the vehicle goes forward; push it outside, the vehicle goes backward. And gives an alarm sound.

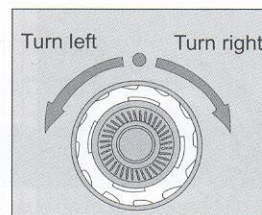

Steering knob: The car turns right when the knob is turned to the clockwise; the car turns left when it is turned the opposite direction. It makes emulational slowdown sound.

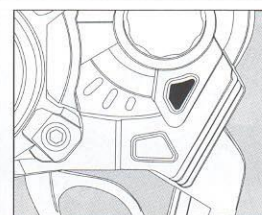

The car light key-press: Press the big light of the car once, it shines; press again, the light goes out.

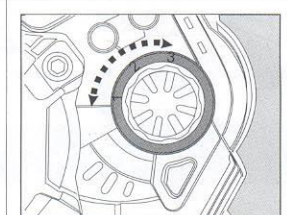

Turn the shift gears knob clockwise, the car can gear electronically. When turning once, the indicator lamp changes circularly as the following:
speed1 → speed2 → speed3

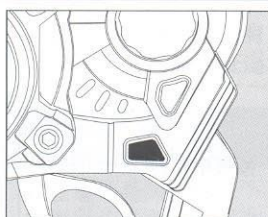

Startup, horn & auto model key-press: press the retrofire of the car, the horn will make the sound of engine. The startup key-press is also a multifunction key-press.

Press the startup key-press until the horn makes a sound. The engine of the car goes out, it is awaiting orders to set off.

Press the startup key-press until the horn makes two sounds. The car will get into the auto perform state.

Auto perform state: The car can go forward/backward, turn left/right, etc.

Note: The car can perform the actions completely only on the minimum of 10 sq.m. ground. If there are obstructions in front of the car when running, press the trigger or the steering knob to stop the performance for fear of damaging your car.

NOTE:

THE MANUFACTURER IS NOT RESPONSIBLE FOR ANY RADIO OR TV INTERFERENCE CAUSED BY UNAUTHORIZED MODIFICATIONS TO THIS EQUIPMENT. SUCH MODIFICATIONS COULD VOID THE USER AUTHORITY TO OPERATE THE EQUIPMENT.