

CALL OF DUTY

MQ-27 STUNT DRONE

Instruction Manual

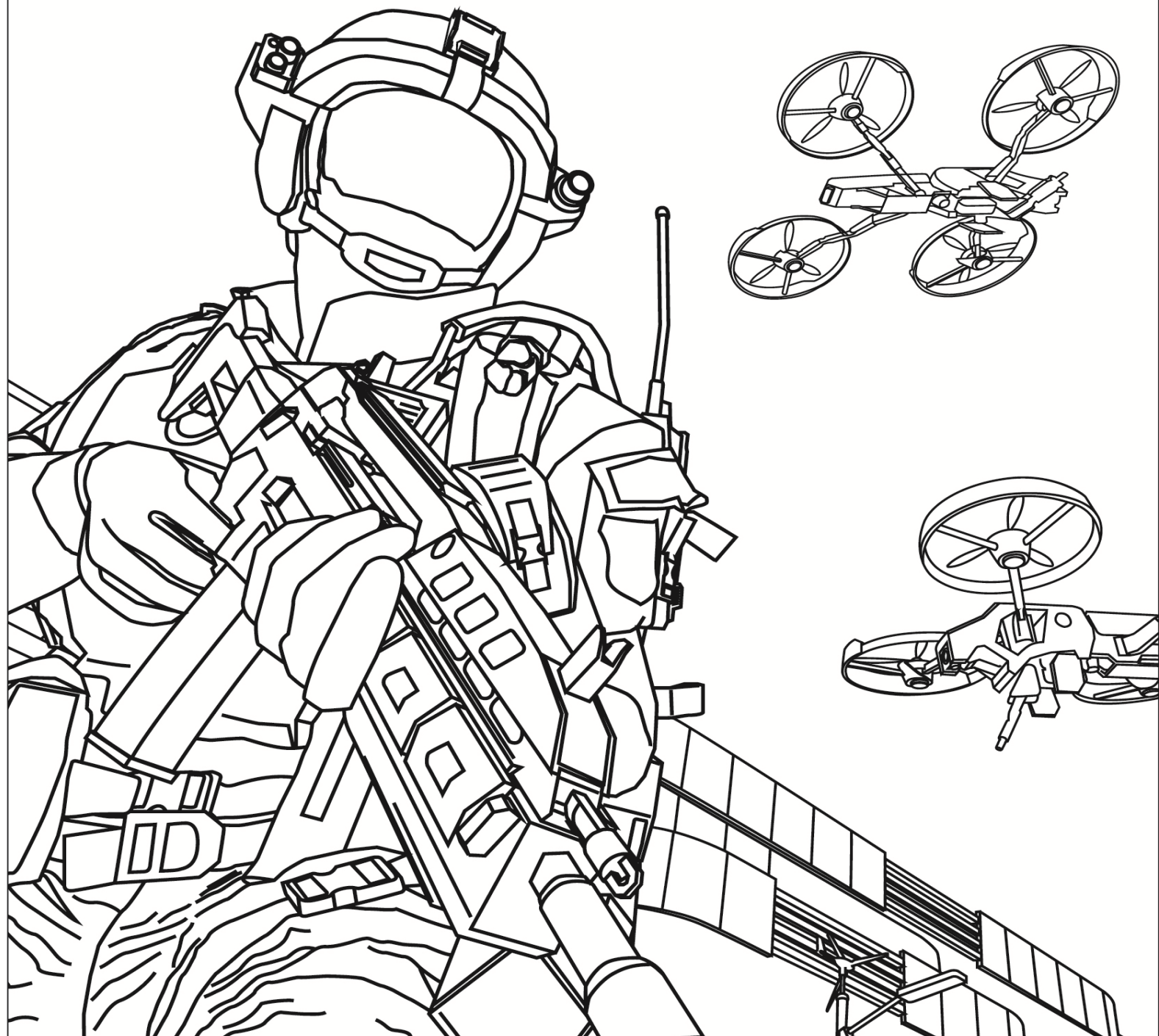

INTRODUCTION

Congratulations on purchasing your Call of Duty drone! This aircraft uses a six-axis gyroscope to make it easier to fly and control **both indoors and outdoors**. Please carefully read this manual before operating your drone. Keep this manual for future reference.

Before your first flight, **please take the time to carefully read this manual containing important flight information that will help your flight go more smoothly.**

TABLE OF CONTENTS

Introduction	1
Table of Contents	1
Notice	1
Warnings	2
Additional Warnings and Precautions	2
Safety Notes	2
Included	3
Drone Diagram	3
Remote Controller Diagram	4
Remote Controller Battery Installation	4
Charging Your Drone	4
Syncing the Quad and Remote	5
Flight Controls	6
Practice Tips	7
Trimming the Quad	7
Recalibrating the Quad	8
Headless Mode	8
One Key Return	8
Flips and Rolls	9
Speed Selection	9
Changing the Blades	9
Troubleshooting	10

NOTICE

All instructions, warranties, and other collateral documents are subject to change at the sole discretion of our company.

WARNINGS

Read the ENTIRE instruction manual to become familiar with the features of the product before operating. Failure to operate the product correctly can result in damage to the product, personal property, or cause serious injury. This is a sophisticated hobby product. It must be operated with caution and common sense, and requires some basic mechanical ability. Failure to operate this product in a safe and responsible manner could result in injury or damage to the product or property. This product is not intended for use by children without direct adult supervision. This manual contains instructions for safety, operation, and maintenance. It is essential to read and follow all the instructions and warnings in this manual, prior to assembly, set up, or use, in order to operate correctly and avoid damage or serious injury.

ADDITIONAL WARNINGS AND PRECAUTIONS

1. Age Recommendation: Not for children under 14 years of age. This is not a toy.
2. Always operate in open spaces away from obstacles, people, and hazards.
3. Always follow directions and warnings for this and any optional equipment carefully. (Chargers, Rechargeable battery packs, etc)
4. Always keep small parts and electrical parts out of the reach of children.
5. Always avoid water exposure to all equipment not specifically designed and protected for this purpose. Moisture can cause damage to electronics.
6. Never place any portion of the model in your mouth as it could cause serious injury or even death.
7. Never operate your model with low batteries.

SAFETY NOTES

If this is your first time flying a quadcopter read the manual carefully. Seek the help of an experienced pilot to help you fly. These safety instructions are intended not only for the protection of your drone but also to protect your own safety. Improper operation can cause injury or property damage.

This product is suitable for indoor and outdoor use. Please make sure you choose a flight area with no obstacles and maintain a safe distance from people and pets. Do not operate near power lines.

RC models are composed of many precise electrical components. It is important to keep the model and associated equipment away from moisture and other contaminants. The introduction of exposure to water or moisture in any form can cause the model to malfunction or crash. Do not operate or expose to rain or moisture.

To avoid a potential fire hazard from batteries, do not short, reverse polarity, or puncture batteries. Battery charging should be done under adult supervision at all times, at a location out of the reach of children. Do not mix Ni-Cad and Alkaline batteries.

Make sure the batteries are installed correctly to ensure correct polarity. If you do not plan to use your drone for an extended period of time, remove the batteries from the controller to avoid battery leakage, which may damage the controller. Please dispose depleted batteries according to local laws and ordinances.

Li-Polymer batteries have higher operational risks compared to other batteries. It is imperative to follow proper operational guidelines. The manufacturer and dealer assume no liability for accidental damages caused by improper usage. Do not use any other charger other than the supplied charger included in this packaging in order to avoid potential fire or explosion. Do not crush, disassemble, burn, or reverse polarity.

RC models are made from various forms of plastic very susceptible to damage or deformation due to extreme heat and cold. Make sure not to store the model near any heat source or adverse temperatures.

INCLUDED

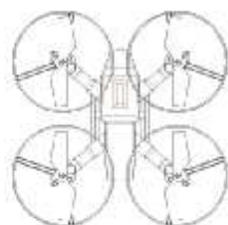

Drone x1



Remote Controller x1



Li-Polymer Battery x1



Screwdriver x1



USB Charger x1

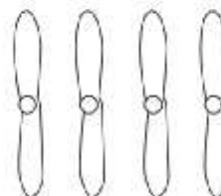

Extra Blades x4

DRONE DIAGRAM

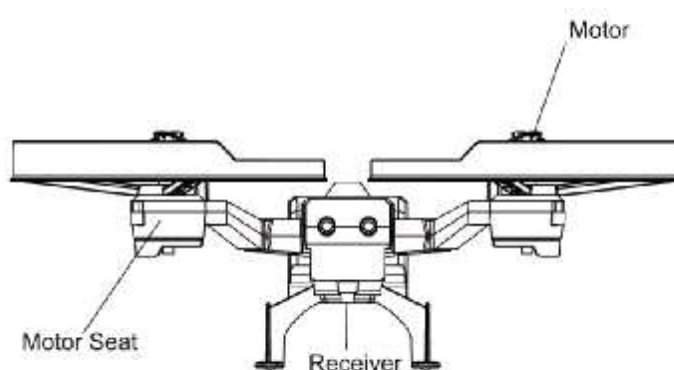
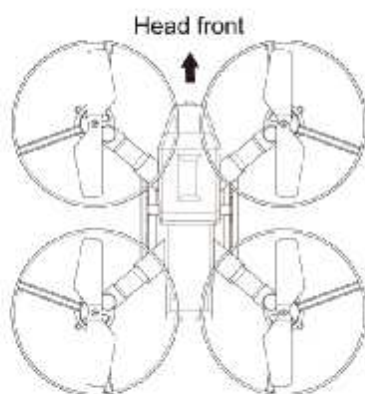

REMOTE CONTROLLER DIAGRAM

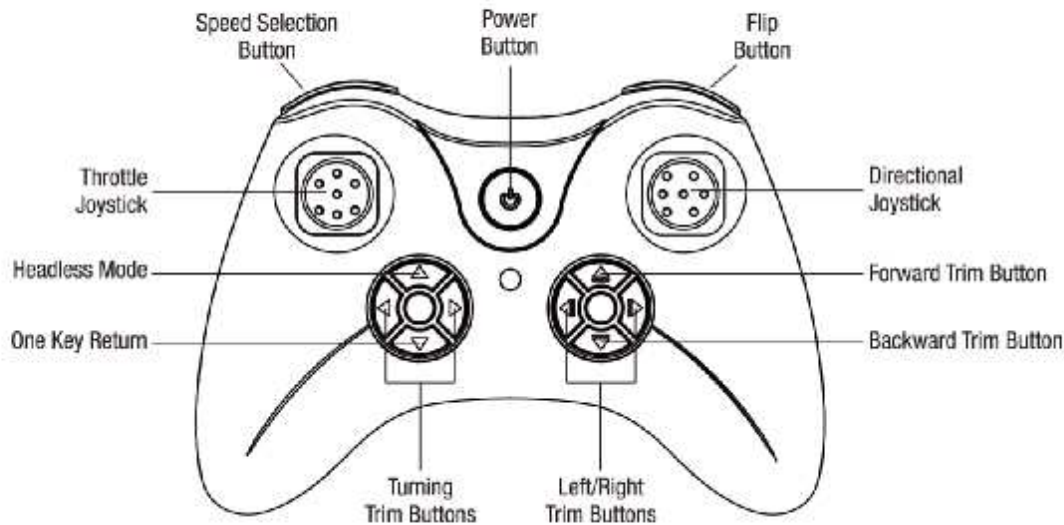

REMOTE CONTROLLER BATTERY INSTALLATION

To install batteries, use the included screwdriver to open the battery cover. Rotate counterclockwise to loosen screw. Insert 3 AA batteries into the remote. Make sure the batteries are installed in the correct polarity as indicated in the controller. Do not mix old and new batteries or batteries with different chemistries. Reattach battery cover. Rotate screw clockwise to refasten.

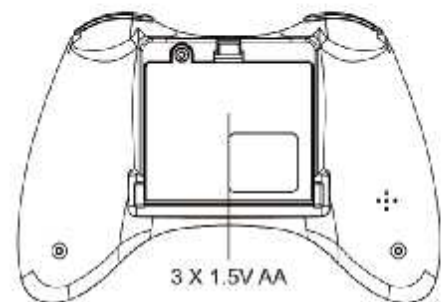

CHARGING YOUR DRONE

To charge your drone, first slide open the battery cover and disconnect the battery from the drone. Plug the provided USB charger into a USB port. A red light on the USB charger will turn on. Connect the battery to the USB charger. The light on the charger will turn off. The battery is now charging. The red light will turn on again once the charging process has completed. Always charge your drone under adult supervision and out of the reach of children. Charging time is approximately 40 minutes. When you are ready to fly your drone again, reinsert the battery into the bottom of the drone and close the cover.

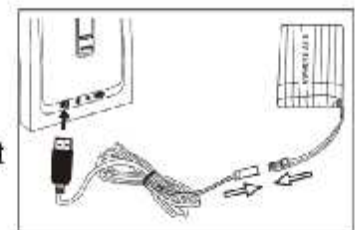

SYNCING THE QUAD AND REMOTE

1. Insert the battery into the drone, connect its wires, and place it on a flat surface. The lights on the drone will begin to flash. Do not move the drone during the syncing process to ensure the gyroscope stays balanced.



2. Lower the throttle joystick on the remote to its lowest position. Turn the remote on. The lights on the drone will stop flashing and stay on.

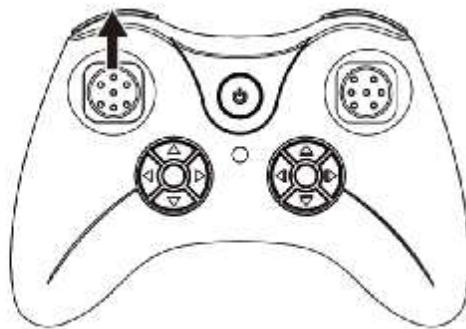

3. Push the throttle joystick to its highest position and the remote will beep. Now move it to its lowest position again and the remote will beep a second time. The drone and remote controller have been synced together. You are now ready to fly.



If you are not going to use your drone for an extended period of time, please take out the batteries in your remote controller. Potential battery leakage could occur and possibly damage the remote or create a fire hazard.

FLIGHT CONTROLS

Before flying your drone, it is highly recommended that you familiarize yourself completely with its controls. Read through the instruction manual completely before attempting your first flight.

Elevation

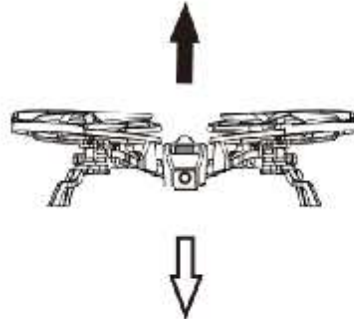

Push up on the throttle joystick.
The drone will begin to ascend.

Pull down on the throttle joystick.
The drone will begin to descend.

Turning

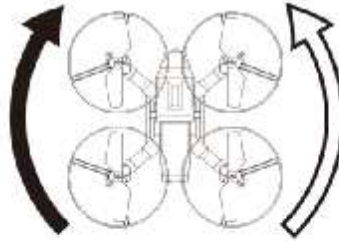

Push the throttle joystick to the right.
The drone will turn to right.

Push the throttle joystick to the left.
The drone will turn to left.

Forward/Backward

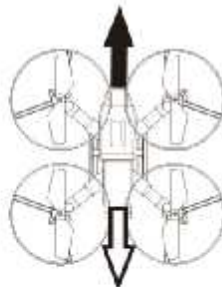

Push the directional joystick up.
The drone will fly forward.

Pull the directional joystick back.
The drone will fly backward.

Aileron

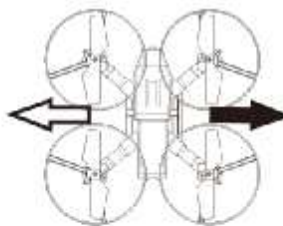
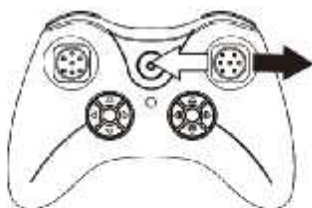

Push the directional joystick to the right.
The drone will fly to the right.

Push the directional joystick to the left.
The drone will fly to left.

PRACTICE TIPS

Use these recommended practice exercises to become a better drone pilot:

Elevation: Raise the drone using the throttle joystick. Gradually lower the drone so it lands softly to the ground.

Direction: Move the drone in a cross pattern using the directional joystick. Move forward, backward, left, right, and back to its original position.

Turning: Turn the drone in a throttle joystick. Turn left and right repeatedly, and back to its original position.

Flying: Once you have mastered the previous three exercises, draw a circle on the ground. Practice flying within the confines of the circle. Narrow the circle as your skills progress.

TRIMMING THE QUAD

If your drone is leaning to or favoring a side, you may need to use the trim feature to balance it out so it flies straight.

Forward/Backward

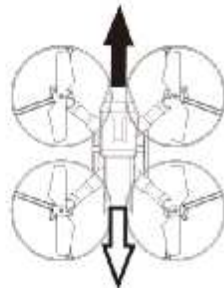

If the drone leans forward, press the Backward Trim button until it balances out.

If the drone leans backward, press the Forward Trim button until it balances out.

Left/Right

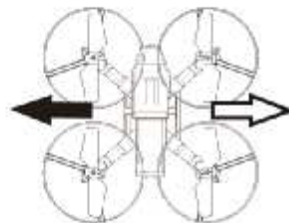
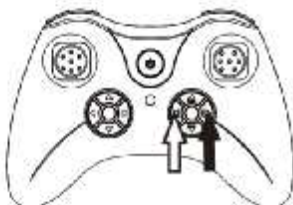

If the drone leans left, press the Right Trim button until it balances out.

If the drone leans right, press the Left Trim button until it balances out.

Turning

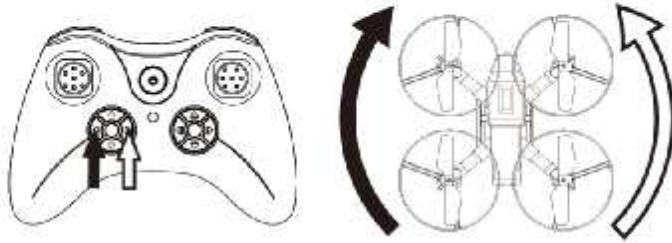

If the drone spins left, press the Right Turn Trim button until it balances out.

If the drone spins right, press the Left Turn Trim button until it balances out.

RECALIBRATING THE QUAD

If your drone is leaning to or favoring a side, you may need to recalibrate the drone to balance it out so it flies straight.

To recalibrate, place the drone on a flat surface. Hold the Throttle Joystick down and to the left and the Directional Joystick down and to the right as depicted in the figure. The lights on the drone will flash for 3 seconds. As soon as the lights on the quad stop blinking, recalibration is complete and the quad should be balanced.



HEADLESS MODE

When in Headless Mode, no matter what direction the quadcopter faces, it will respond according to the direction pushed on the remote. (Forward on the remote will make the quadcopter fly forward, even if it is pointing in another direction.) To enter Headless Mode, land the drone on a flat surface. Press the Headless Mode button. The remote will keep on beeping. To exit Headless Mode, simply press the button again.

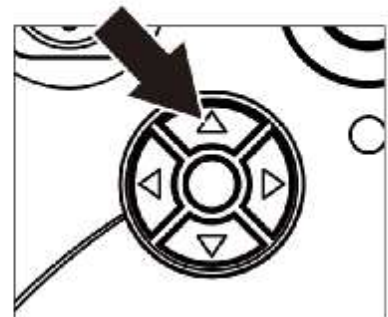

ONE KEY RETURN

When using One Key Return, no matter what direction the quadcopter faces, the aircraft will automatically fly directly back to the remote. To enter One Key Return, simply press the One Key Return button. The remote will beep as the drone returns to the remote. To exit One Key Return, press the button again or press forward on the Directional Joystick.

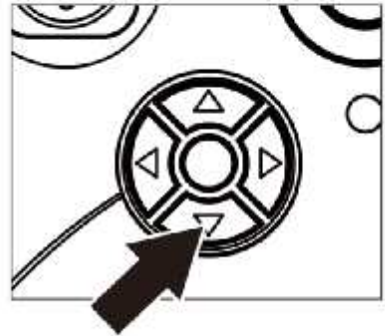

FLIPS AND ROLLS

Your drone can perform impressive flips and rolls in midair. In order to do this, press the directional joystick on your remote during flight. Move the joystick in any direction and the aircraft will perform a coinciding flip.



SPEED SELECTION

Your drone can fly at three speeds. To select a speed, simply press the Speed Selection button on your remote to select the speed level. Your remote will beep each time you switch speeds.

- 1 Beep: Slow Speed
- 2 Beeps: Medium Speed
- 3 Beeps: Fast Speed



CHANGING THE BLADES

If a blade breaks or falls off your drone after a crash, it will be up to you to repair it. Simply push one of the extra blades onto the exposed motor. It is important for the correct blade to be put on the corresponding motor or the drone will not fly. A letter is marked on each blade to indicate which motor it should go on.

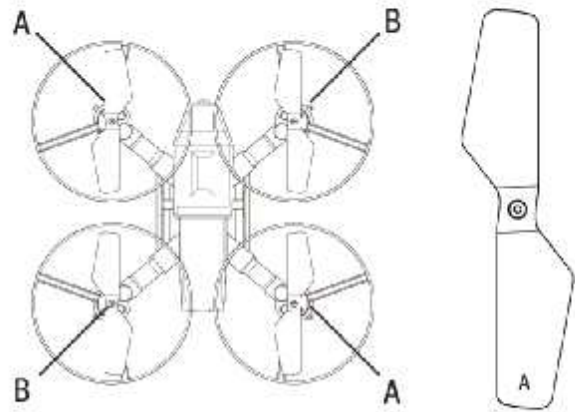

TROUBLESHOOTING

Problem	Cause	Solution
Drone's LED lights blink continuously for more than 4 seconds after drone is turned on and does not respond to controller.	Unable to sync drone to remote controller.	Repeat power sequence and re-sync. (See pg. 5)
No response after quad is turned on.	1. Remote batteries have been depleted. 2. Batteries are installed at incorrect polarity.	1. Replace batteries. 2. Reinstall batteries at correct polarity.
Motor does not respond to throttle.	Battery has been depleted.	Recharge quad battery.
Motor spins but drone doesn't take off.	1. Bent rotor blades. 2. Quad battery is depleted.	1. Replace damaged blade. 2. Recharge battery.
Quad is making a loud, vibrating noise.	Bent or damaged rotor blades.	Replace damaged blade.
Quad still wanders forward after trim adjustment.	Forward trim is too high.	1. Lower forward trim. 2. Recalibrate drone.
Cannot fly after crash.	1. Motor fell out. 2. Gear has been loosened.	1. Reinstall motor. 2. Tighten gear.

© 2016 Activision Publishing, Inc. ACTIVISION and CALL OF DUTY are trademarks of Activision Publishing, Inc.

All rights reserved

DGL Toys™ is an innovative division of DGL Group, Ltd.
Other trademarks and trade names are those of their respective owners.

DGL Toys,
195 Raritan Center Parkway, Edison, NJ 08837.

Specifications, colors and contents may vary from illustrations.

BATTERY WARNING:

- Do not mix alkaline, standard (carbon zinc), rechargeable (nickel hydride) batteries.
- Do not mix old and new batteries.
- Non-rechargeable batteries should not be recharged.
- Rechargeable batteries should be removed from the appliance before being charged.
- Rechargeable batteries should be charged under adult supervision only.
- Exhausted batteries should be removed.
- The supply terminals should not be short-circuited.
- Only batteries of the same or equivalent type are recommended to be used.
- Batteries should be inserted with the correct polarity.



FCC ID: 2AANZC0DQDRMQ27

Manufactured in China.
Batch Ref: 161001DGL
Model Number: COD-QDR-MQ27

WARNING:
CHOKING HAZARD—Small parts.
Not for children under 3 years.



Contains 1 x 3.7V LiPo battery pack. Requires 3 x 1.5 AA (LR6) alkaline batteries (not included). Batteries or battery packs must be recycled or disposed of properly. When this product has reached the end of its useful life it should not be disposed of with other household waste. The Waste Electrical and Electronic Equipment Regulations require it to be separately collected so that it can be treated using the best available recovery and recycling techniques. This will minimize the impact on the environment and human health from soil and water contamination by any hazardous substances, decrease the resources required to make new products and avoid using up landfill space. Please do your part by keeping this product out of the municipal waste stream! The "wheelie bin" symbol means that it should be collected as "waste electrical and electronic equipment". You can return an old product to your retailer when you buy a similar new one. For other options, please contact your local council.



DGL Toys™, hereby declares that this toy is compliance with the essential requirements and other relevant provisions of Directive 1999/5/EC. A copy of the declaration of conformity can be requested through support@dglusa.com or DGL Toys, 195 Raritan Center Parkway, Edison, NJ 08837.

FCC Statement: This device complies with Part 15 of the FCC rules. Operation is subject to the following two conditions (1) This device may not cause harmful interference, and (2) This device must accept any interference received, including interference that may cause undesired operation.

NOTE:

This equipment has been tested and found to comply with the limits for a Class B digital device, pursuant to part 15 of the FCC Rules. These limits are designed to provide reasonable protection against harmful interference in a residential installation. This equipment generates, uses and can radiate radio frequency energy and, if not installed and used in accordance with the instructions, may cause harmful interference to radio communications. However, there is no guarantee that interference will not occur in a particular installation. If this equipment does cause harmful interference to radio or television reception, which can be determined by turning the equipment off and on, the user is encouraged to try to correct the interference by one or more of the following measures:

Reorient or relocate the receiving antenna.

- Increase the separation between the equipment and receiver.
- Connect the equipment into an outlet on a circuit different from that to which the receiver is connected.
- Consult the dealer or an experienced radio/TV technician for help.

Use of shielded cable is required to comply with Class B limits in Subpart B of Part 15 of the FCC rules. Do not make any changes or modifications to the equipment unless otherwise specified in the manual. If such changes or modifications should be made, you could be required to stop operation of the equipment.

This Class B digital apparatus complies with Canadian ICES-003.

This device complies with Industry Canada License-exempt RSS-210. Operation is subject to the following two conditions (1) this device may not cause interference, and (2) this device must accept any interference including interference that may cause undesired operation of the device.

Limited 90-Day Warranty

DGL Group, Ltd. warrants to the original consumer that this product is free from any electrical or mechanical defects for a period of 90 DAYS from the date of purchase. If any such defect is discovered within the warranty period, DGL Group, Ltd. will repair or replace the unit free of charge upon receipt of the unit, shipped postage prepaid and insured to our warranty center. The warranty covers normal consumer use and does not cover damage that occurs in shipment or failure that results from alterations, accident, misuse, abuse, neglect, wear and tear, inadequate maintenance, commercial use or unreasonable use of the unit. Removal of any parts/components voids all warranties. This warranty does not cover cost of repairs made or attempted outside by third-party individuals and fitness, are hereby limited to 90 DAYS from the date of purchase. Consequential or incidental damages resulting from a breach of any applicable express or implied warranties are hereby excluded. Some states do not allow limitations on the duration of implied warranties and do not allow exclusion of incidental or consequential damages, so the above limitations and exclusions in these instances may not apply.

REPAIR/REPLACE PRODUCT

If your product begins to malfunction or stop working, immediately call or email our warranty center at the phone/email listed below. If it is determined that a return is necessary, our warranty department will issue you an RMA number/form and an address to the nearest return center to ship the product to. **IMPORTANT NOTICE:** We will reject all returns that are not accompanied by an issued RMA form and number so make sure to contact our warranty center before attempting to return your product!

PREPARATION FOR SHIPPING YOUR PRODUCT

Please repack your product in a durable box, preferably in the original carton, and send it prepaid, and adequately insured. Include the RMA form that was issued by our warranty department along with your daytime telephone number and email address (if available) inside the shipping carton. If your warranty has expired, contact our warranty center for charged service. For further information please send all inquiries to support@dglusa.com

IMPORTANT NOTICE!

**DO NOT ATTEMPT TO SHIP YOUR PRODUCT BACK WITHOUT
FIRST CONTACTING OUR WARRANTY DEPARTMENT AT:**

DGL Group. Ltd.
WARRANTY REPLACEMENT DEPARTMENT
TEL: 888-987-3089
support@dglusa.com

Safety Guidelines

- Follow community-based safety guidelines, as developed by organizations such as the Academy of Model Aeronautics (AMA).
- Fly no higher than 400 feet and remain below any surrounding obstacles when possible.
- Keep your drone in eyesight at all times, and use an observer to assist if needed.
- Remain well clear of and do not interfere with manned aircraft operations, and you must see and avoid other aircraft and obstacles at all times.
- Do not intentionally fly over unprotected persons or moving vehicles, and remain at least 25 feet away from individuals and vulnerable property.
- Contact the airport or control tower before flying within five miles of an airport.
- Do not fly in adverse weather conditions such as in high winds or reduced visibility.
- Do not fly under the influence of alcohol or drugs.
- Ensure the operating environment is safe and that the operator is competent and proficient in the operation of the drone.
- Do not fly near or over sensitive infrastructure or property such as power stations, water treatment facilities, correctional facilities, heavily traveled roadways, government facilities, etc.
- Check and follow all local laws and ordinances before flying over private property.
- Do not conduct surveillance or photograph persons in areas where there is an expectation of privacy without the individual's permission.

WARNING!

To reduce the risk of fire or burns:

Do not disassemble, crush, puncture, or short external connectors contacts.

Use only with specified charger and player.

Do not dispose of in fire or water.

Do not expose to high temperature above 140° F (60° C).

Store between 32° F (0° C) and 140° F (60° C).

Keep away from children.

See operating instructions of this battery or product.



Li-ion Battery
Must Be Disposed
Of Properly

Batteries should be recycled or disposed of as per State and Local guidelines.

Warning: Changes or modifications to this unit not expressly approved by the party responsible for compliance could void the user's authority to operate the equipment.

NOTE: This equipment has been tested and found to comply with the limits for a Class B digital device, pursuant to Part 15 of the FCC Rules. These limits are designed to provide reasonable protection against harmful interference in a residential installation. This equipment generates, uses and can radiate radio frequency energy and, if not installed and used in accordance with the instructions, may cause harmful interference to radio communications.

However, there is no guarantee that interference will not occur in a particular installation. If this equipment does cause harmful interference to radio or television reception, which can be determined by turning the equipment off and on, the user is encouraged to try to correct the interference by one or more of the following measures:

- Reorient or relocate the receiving antenna.
- Increase the separation between the equipment and receiver.
- Connect the equipment into an outlet on a circuit different from that to which the receiver is connected.
- Consult the dealer or an experienced radio/TV technician for help.