

USER MANUAL

WIRELESS RF DEVICE

HT-01 AND HTBS-01 SERIES

Tentative Edition

Table of Content

i)	Notice	1
ii)	Safety Information	2
iii)	Safety Regulations	3
1.	General	4
1.1	Product Features.....	4
1.1.1	HT-01 (Hi Touch RF Tag)	4
1.1.2	HTBS-01 (Hi Touch Base Station).....	4
1.2	Operating Specification	5
1.2.1	HT-01 (Hi Touch RF Tag)	5
1.2.2	HTBS-01 (Hi Touch Base Station).....	5
1.3	Battery Specification	5
1.3.1	HT-01 (Hi Touch RF Tag)	5
2.	Dimension.....	6
2.1	HT-01 (Hi Touch RF Tag)	6
2.2	HTBS-01 (Hi Touch Base Station).....	6
3.	Label Information for HT-01 (Hi Touch RF Tag) and HTBS-01(Hi Touch Base Station)	7
3.1	For all countries except Japan	7
3.2	For Japan Only.....	8
4.	Hi-Touch Operation with SM-700 Scale (Example).....	9
5.	Revision Records	11

i) Notice

DIGI®

The material contained in this document is proprietary and for information only and is subject to change without notice. Teraoka Weigh-System assumes no responsibility for any errors or damages arising from misinterpretation of any procedure.

Screen displays, operating procedures and supporting features might vary with different software version releases.

This document shall not be reproduced whether in part or whole without the written consent from Teraoka Weigh-System Pte Ltd.

Teraoka Weigh-System Pte Ltd
4, Leng Kee Road
#06-01 SIS Building
Singapore 159088

ii) Safety Information

The operator of the equipment shall comply with the safety and warning indications and procedures outlined in this document. Teraoka Weigh-System Pte Ltd assumes no responsibility or liability for failure to comply with these requirements.

- For continued protection against fire hazard replace only with battery of same rating and type.
- Avoid overloading the product beyond its rated maximum capacity
- Trained and qualified personnel shall only carry out repair and servicing of product.

Disclaimer:

Specifications are subject to change without notice. All dimensions shown are approximate. Please be aware that Teraoka has indicated that its hardware and software used in the product may require additional updates in the future as our product is continually under development. The need for such updates most likely applies to the Printer software.



CAUTIONS:

1. DO NOT **DISPOSE** THE UNIT INTO FIRE.
2. **NOT RECOMMENDED TO REPLACE THE BATTERY IN THIS UNIT.**
3. FOR CONTINUED PROTECTION AGAINST RISK OF FIRE, IF REPLACE ONLY WITH SAME TYPE AND RATING OF BATTERY.
4. DANGER OF EXPLOSION IF BATTERY IS INCORRECTLY REPLACED. REPLACE ONLY WITH THE SAME OR EQUIVALENT TYPE THAT RECOMMENDED. DISPOSE OF THE BATTERY **ACCORDINGS** TO THE MANUFACTURER INSTRUCTION.

iii) Safety Regulations



Federal Communication Commission Interference Statement

This equipment has been tested and found to comply with the limits for a Class B digital device, pursuant to Part 15 of the FCC Rules. These limits are designed to provide reasonable protection against harmful interference in a residential installation. This equipment generates uses and can radiate radio frequency energy and, if not installed and used in accordance with the instructions, may cause harmful interference to radio communications. However, there is no guarantee that interference will not occur in a particular installation. If this equipment does cause harmful interference to radio or television reception, which can be determined by turning the equipment off and on, the user is encouraged to try to correct the interference by one of the following measures:

- Reorient or relocate the receiving antenna.
- Increase the separation between the equipment and receiver.
- Connect the equipment into an outlet on a circuit different from that to which the receiver is connected.
- Consult the dealer or an experienced radio/TV technician for help.

This device complies with Part 15 of the FCC Rules.

Operation is subject to the following two conditions:

- (1) This device may not cause harmful interference, and
- (2) this device must accept any interference received, including interference that may cause undesired operation.

FCC Caution: Any changes or modifications not expressly approved by the party responsible for compliance could void the user's authority to operate this equipment.

This transmitter must not be co-located or operating in conjunction with any other antenna or transmitter.

IMPORTANT NOTE:

FCC Radiation Exposure Statement:

This equipment complies with FCC RF radiation exposure limits set forth for an uncontrolled environment. To maintain compliance with FCC RF exposure compliance requirements, please avoid direct contact to the transmitting antenna during transmitting.

1. General

1.1 Product Features

1.1.1 HT-01 (Hi Touch RF Tag)

Model	:	HI TOUCH
Dimension (in mm)	:	95.5(L) X 36.0(W) X 20.0(H)
RF Standard	:	IEEE 802.15.4
Modulation	:	O-QPSK with DSSS
Frequency Band	:	2.4 GHz – 2.4835 GHz
Radio Operation Channel	:	Channel 11 to 26
The RF Frequency of channel k is given by	:	$F_c = 2405 + 5(k-11)\text{MHz}$, $k=11,12,\dots,26$
Data Rate	:	Up to 250 kbps
Radio Range	:	Up to 100m in sight
Transmit Power	:	0dBm (max)
Receiver Sensitivity	:	-93dB (typical), PER = 1%

1.1.2 HTBS-01 (Hi Touch Base Station)

Model	:	HI TOUCH BASE STATION
Dimension (in mm)	:	78.0(L) X 53.0(W) X 25.0(H)
RF Standard	:	IEEE 802.15.4
Modulation	:	O-QPSK with DSSS
Frequency Band	:	2.4 GHz – 2.4835 GHz
Radio Operation Channel	:	Channel 11 to 26
The RF Frequency of channel k is given by	:	$F_c = 2405 + 5(k-11)\text{MHz}$, $k=11,12,\dots,26$
Data Rate	:	Up to 250 kbps
Radio Range	:	Up to 100m in sight
Transmit Power	:	0dBm (max)
Receiver Sensitivity	:	-93dB (typical), PER = 1%

1.2 Operating Specification

1.2.1 HT-01 (Hi Touch RF Tag)

Power Source	:	DC 3.0V (Internal Battery)
Operating Temperature	:	-20 °C to 40 °C
Humidity	:	95% max non condensing

1.2.2 HTBS-01 (Hi Touch Base Station)

Power Source	:	5.0V external.
Operating Temperature	:	-20 °C to 40 °C
Humidity	:	95% max non condensing

1.3 Battery Specification

1.3.1 HT-01 (Hi Touch RF Tag)

Battery Type	:	Lithium Manganese Dioxide Batteries
Nominal Voltage	:	3.0V
Nominal Capacity	:	610mAh
Operating Temperature Ranges	:	-20°c to 60 °c
Weight (approx.)	:	6.6g
Dimension in (mm)	:	24.5(Diameter) X 5.0mm(Height)
Recommend Brand	:	Maxell (CR2450)
Life Time	:	5 years

2 Dimension

2.1 HT-01 (Hi Touch RF Tag)

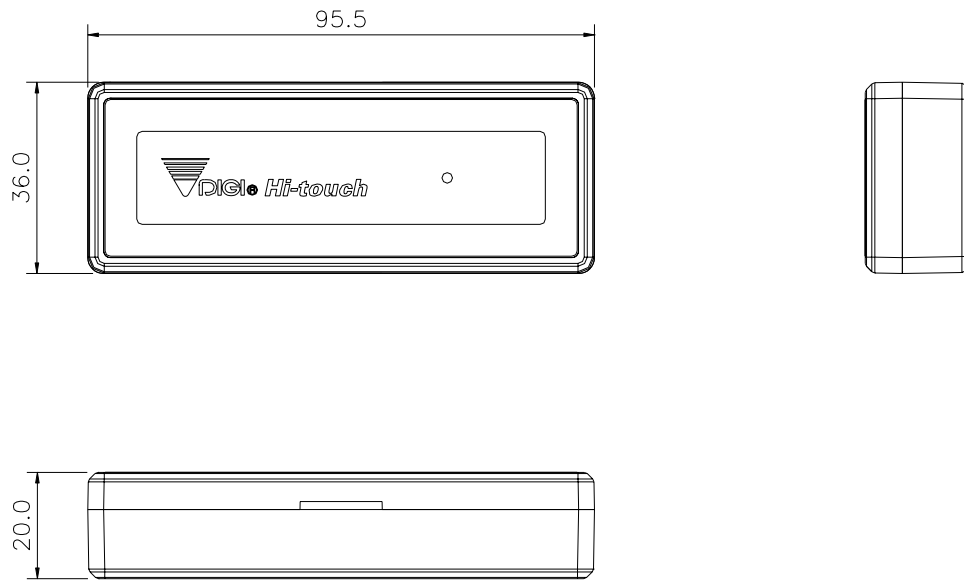

Note: For Japan Model only, the Logo is TERAOKA

2.2 HTBS-01 (Hi Touch Base Station)

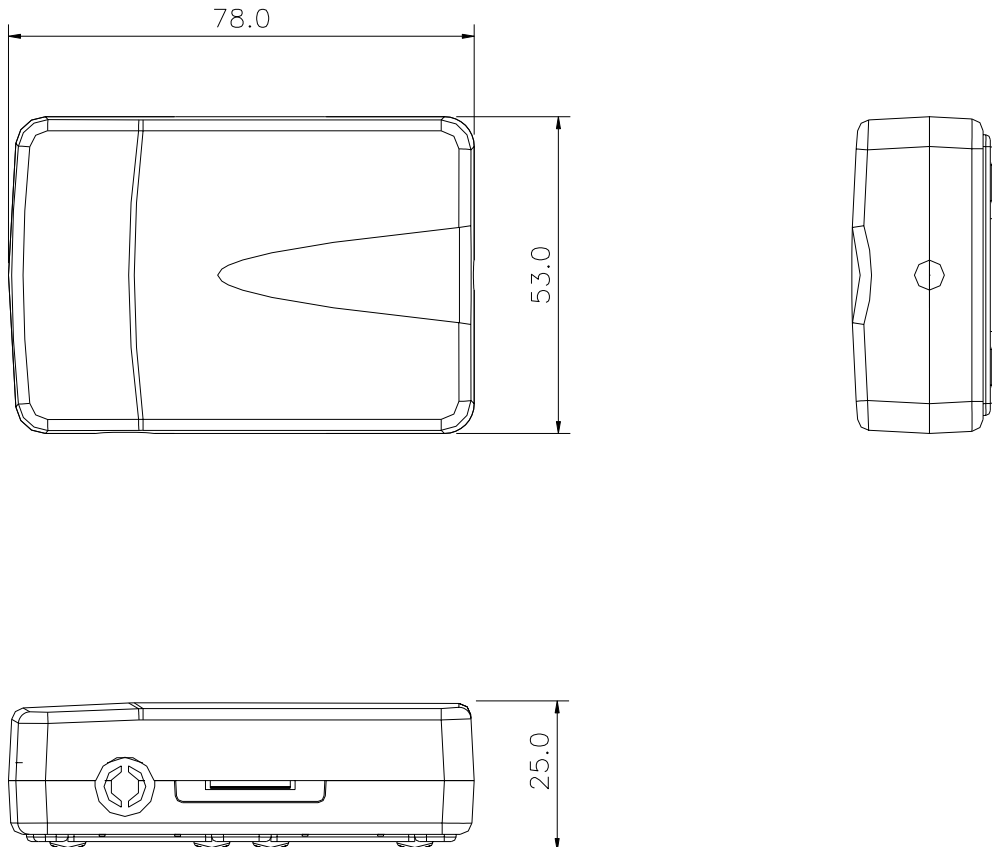

3. Label Information for HT-01 (Hi Touch RF Tag) and HTBS-01(Hi Touch Base Station)

3.1 For all countries except Japan

Hi-Touch RF Tag

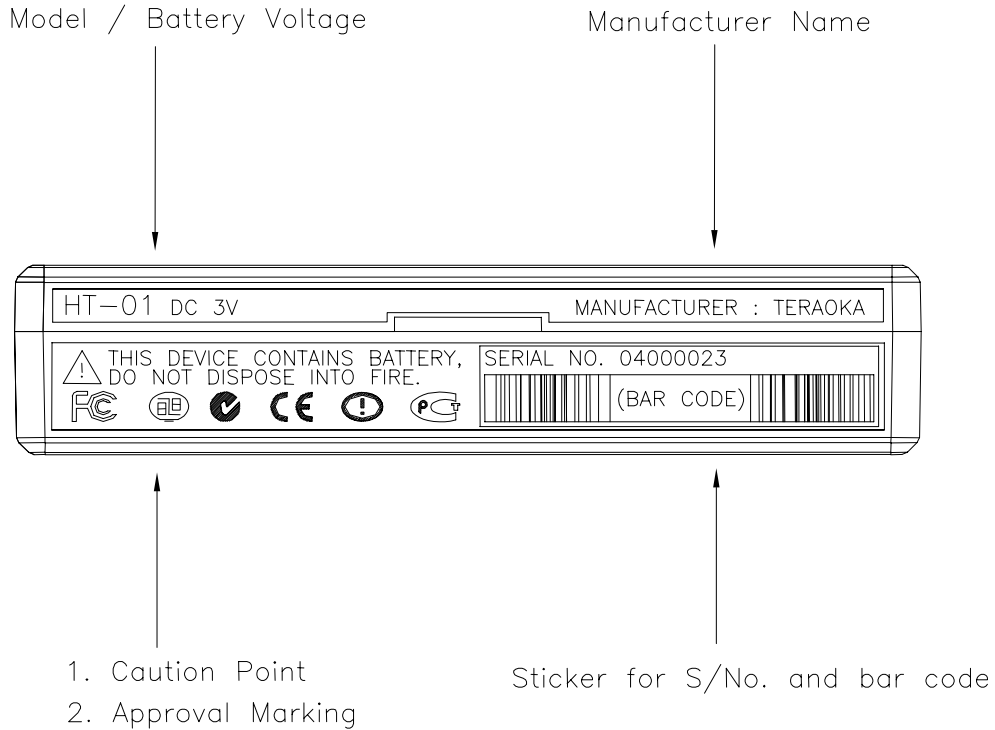

Hi-Touch Base Station

1. Model / Battery Voltage / Power
2. Manufacturer Name
3. Serial Number
4. Approval Marking and Information

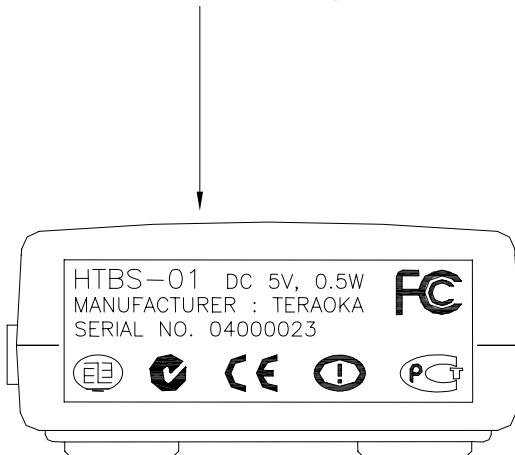

3.2 For Japan Only

Hi-Touch RF Tag

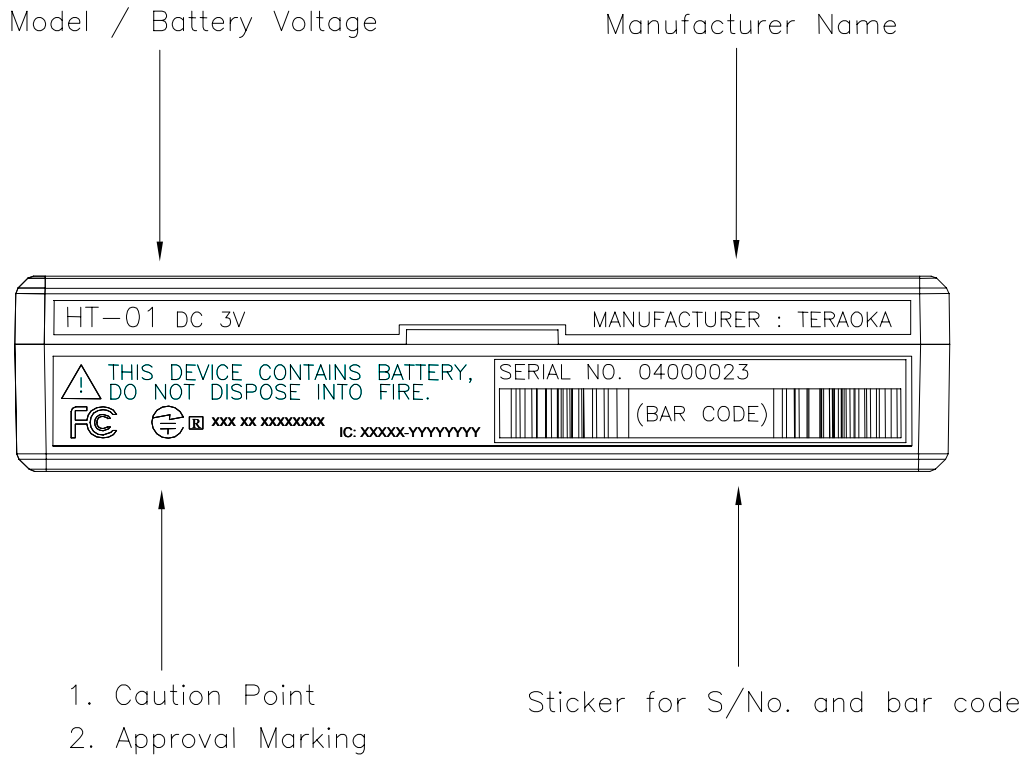

Hi-Touch Base Station

1. Model / Battery Voltage / Power
2. Manufacturer Name
3. Serial Number
4. Approval Marking and Information

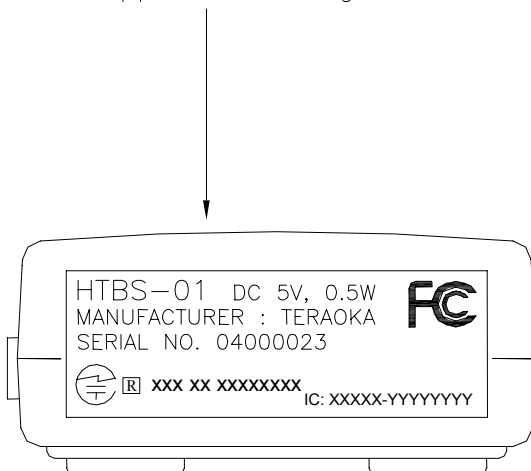

4. Hi-Touch Operation with SM-700 Scale (Example)

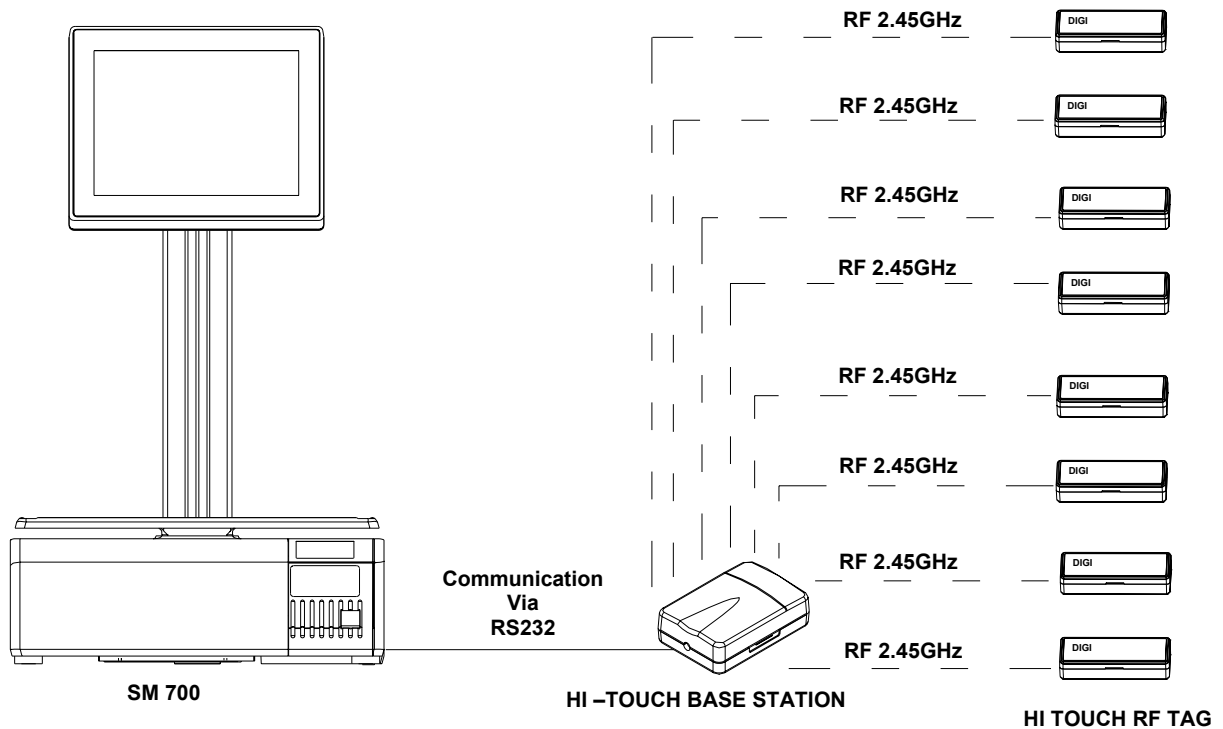

Operate Procedure

<p>The main menu is displayed with the following options: REGISTRATION, MAINTENANCE MENU, PREPACK MODE, SELF SERVICE, PROGRAMMING, REPORT MODE, CLOSING AND REPORT, HELP, and OFF.</p>	<p>The registration mode screen shows a grid of product icons and a numeric keypad. The top display shows TARE: 0.000, WEIGHT: 0.190, PRICE: 0.00, and TOTAL PRICE: 0.00.</p>	<p>The hi touch mode screen shows a numeric keypad and a list of categories: NUMERIC, SEARCH, PRINT KEY, VEGETABLE, SEAFOOD, FRUIT, MEAT, and HI TOUCH.</p>
<p>1. Power on scale, after 2 to 3 minutes, it will show the main menu.</p>	<p>2. Press Registration button to enter registration mode.</p>	<p>3. Press Hi touch button to enter hi touch mode.</p>
<p>The screen displays the first Hi touch tag: APPLE (PLU 000001, 1.50kg). The numeric keypad and category list are visible.</p>	<p>The screen displays two Hi touch tags: APPLE (PLU 000001, 1.50kg) and ALMOND (PLU 000002, 0.45kg).</p>	<p>The screen displays three Hi touch tags: APPLE (PLU 000001, 1.50kg), ALMOND (PLU 000002, 0.45kg), and SWEET & SOUR BEEF RIBS (PLU 000003, 2.90kg).</p>
<p>4. Press Hi touch tag, the preset button of that Hi touch will appear on the screen.</p>	<p>5. Press the others Hi touch tag, the preset button of that Hi touch will appear on the screen.</p>	<p>6. The scale will display preset buttons according to the sequence of the Hi touch tag pressed.</p>

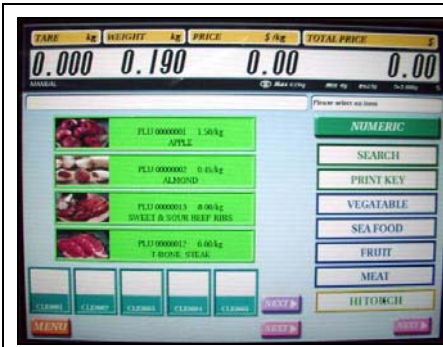

7. If the hi touch tag input is more than 4, the preset button will appear on the next screen. You can use the arrows to go to next page or previous page.



8. If the preset button is not used, after time out it will disappear from the screen.

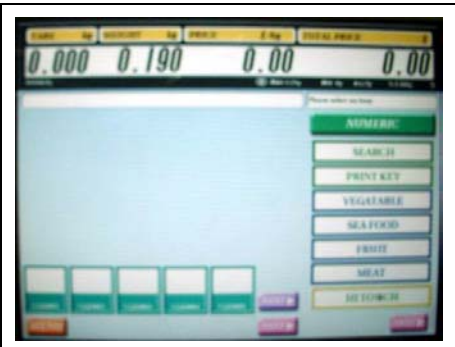

9. To print label, put weight on platter, select preset button and press print key on the mechanical key pad. A label will be printed and the preset key will be disappeared from the screen.

