



User Manual

HD PoE Network Camera

DCS-3010

Preface

D-Link reserves the right to revise this publication and to make changes in the content hereof without obligation to notify any person or organization of such revisions or changes.

Manual Revisions

Revision	Date	Description
1.1	January 11, 2013	DCS-3010 Revision A1 with firmware version 1.10

Trademarks

D-Link and the D-Link logo are trademarks or registered trademarks of D-Link Corporation or its subsidiaries in the United States or other countries. All other company or product names mentioned herein are trademarks or registered trademarks of their respective companies.

Copyright © 2013 by D-Link Corporation.

All rights reserved. This publication may not be reproduced, in whole or in part, without prior expressed written permission from D-Link Corporation.

Table of Contents

Preface	2	Network	36
Manual Revisions.....	2	IP Settings.....	36
Trademarks	2	Port and Access Name Settings.....	39
Product Overview	4	Dynamic DNS	42
Package Contents.....	4	HTTPS.....	43
System Requirements	5	Access List.....	45
Introduction	6	Advanced Settings	47
Features.....	7	Event Management	50
Hardware Overview	8	Motion Detection	50
Front Panel	8	Tamper Detection.....	51
Rear Panel.....	9	Event Settings	52
Side Panel	10	Recording	59
Button Panel	11	Recording Settings.....	59
Hardware Installation	12	Local Storage.....	61
Configuration	13	PTZ Control	62
Viewing Camera via Web Browser	18	Digital PTZ.....	62
D-ViewCam Setup Wizard.....	20	System	63
Live Video	22	User Settings	63
Client Setup	26	Device Settings.....	64
Setup.....	27	Time and Date.....	65
Basic Setup.....	27	Maintenance.....	66
Advanced Setup.....	28	Parameter List	68
System Overview	29	Logs	69
Video	30	Technical Specifications	70
Video Settings.....	30	Contacting Technical Support	72
Image Settings.....	33	Warranty	73
Audio Settings	35	Registration	81

Product Overview Package Contents



**DCS-3010
HD PoE Network Camera**



Camera Stand

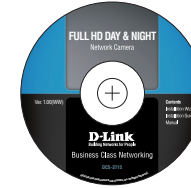

**User Manual and Software on
CD-ROM**



Power Adapter *

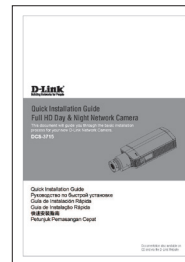

Quick Install Guide



CAT5 Ethernet Cable



**Allen Wrench and Lens Back
Focus Tool**

If any of the above items are missing, please contact your reseller.

* Depending on your region, a power adapter may not be included.

System Requirements

- Operating System: Microsoft Windows® 2000, XP, Vista, 7
- Memory : At least 256MB of memory (512MB recommended)
- Web Browser: Internet Explorer 7 or higher, Firefox, Chrome, Safari
- VGA card resolution: SVGA or XGA (1024x768 or above)
- CPU: 1.7GHz or above (2.8GHz plus processor with 512MB memory and a 32MB video card is required for multiple camera viewing and recording in IP surveillance program)
- An available Ethernet connection

Introduction

DCS-3010 is an HD, full frame rate network camera with H.264 compression. The DCS-3010 connects to a network to provide high-quality live video which can be viewed or recorded locally or over the Internet. The vivid video quality and superb high resolution provide highly detailed imaging for surveillance and security applications. DCS-3010 provides multiple streaming and flexible viewing window settings for different surveillance purposes, either for regular recording or mobile view. A built-in microSD card slot can record important events on a microSD card as a local backup; and it's very easy to retrieve.

The included D-Link D-ViewCam™ is sophisticated software which allows users to manage up to 32 network cameras, set e-mail alert notifications, create recording schedules and use motion detection to record directly to a hard drive. D-ViewCam™ also allows users to upload a floor plan to create a realistic layout of the premises where cameras are located, further simplifying the management process.

Features

HD Surveillance

The DCS-3010 provides HD industrial standard 16:9 wide-screen video for IP surveillance. With the fixed lens, it is a high performance high quality network camera. Flexible viewing window settings allow users to monitor multiple ROI's (Regions of Interest) from a single camera; all utilizing high definition resolution. The DCS-3010 can also simulate wide area surveillance by using the *Digital PTZ* (digital pan, tilt and zoom) feature.

Flexible Connectivity

The DCS-3010 incorporates Power over Ethernet (PoE), allowing it to be easily installed in a variety of locations without the need for supplemental power cabling.

Advanced Web User Interface

The DCS-3010 features D-Link's latest-generation graphical user interface. This freshly designed web interface features a clean, compact and professional home screen which dramatically increases usability. Menu navigation is simplified thanks to a tree view which logically groups functions, helping users to quickly find what they need. Likewise, intuitive graphic icons reduce the amount of text and clutter within the browser window. New users will appreciate the convenient contextual help which offers an easy way to find assistance with camera management tasks.

3GPP Mobile Surveillance

Support for 3GPP Mobile Surveillance allows users to view a live-video feed from a 3GPP compatible Internet-ready mobile device. This extends monitoring capability, allowing users to check the camera's video feed while on the go without a computer.

Hardware Overview

Front Panel

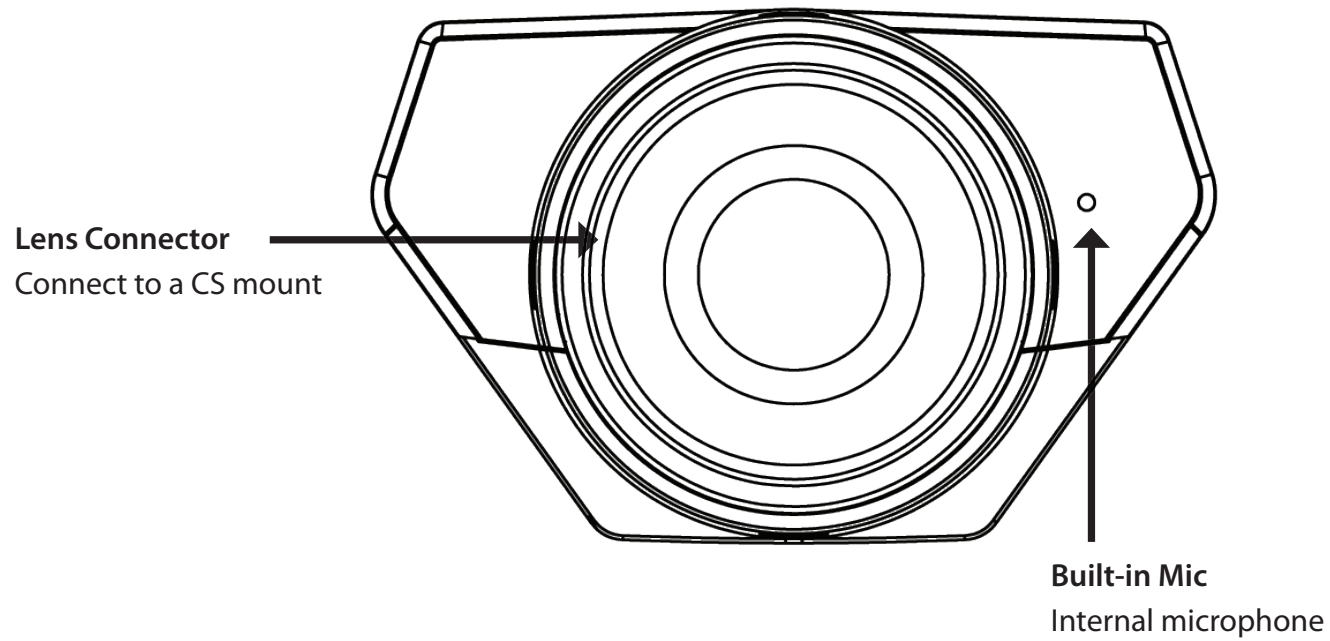

Rear Panel

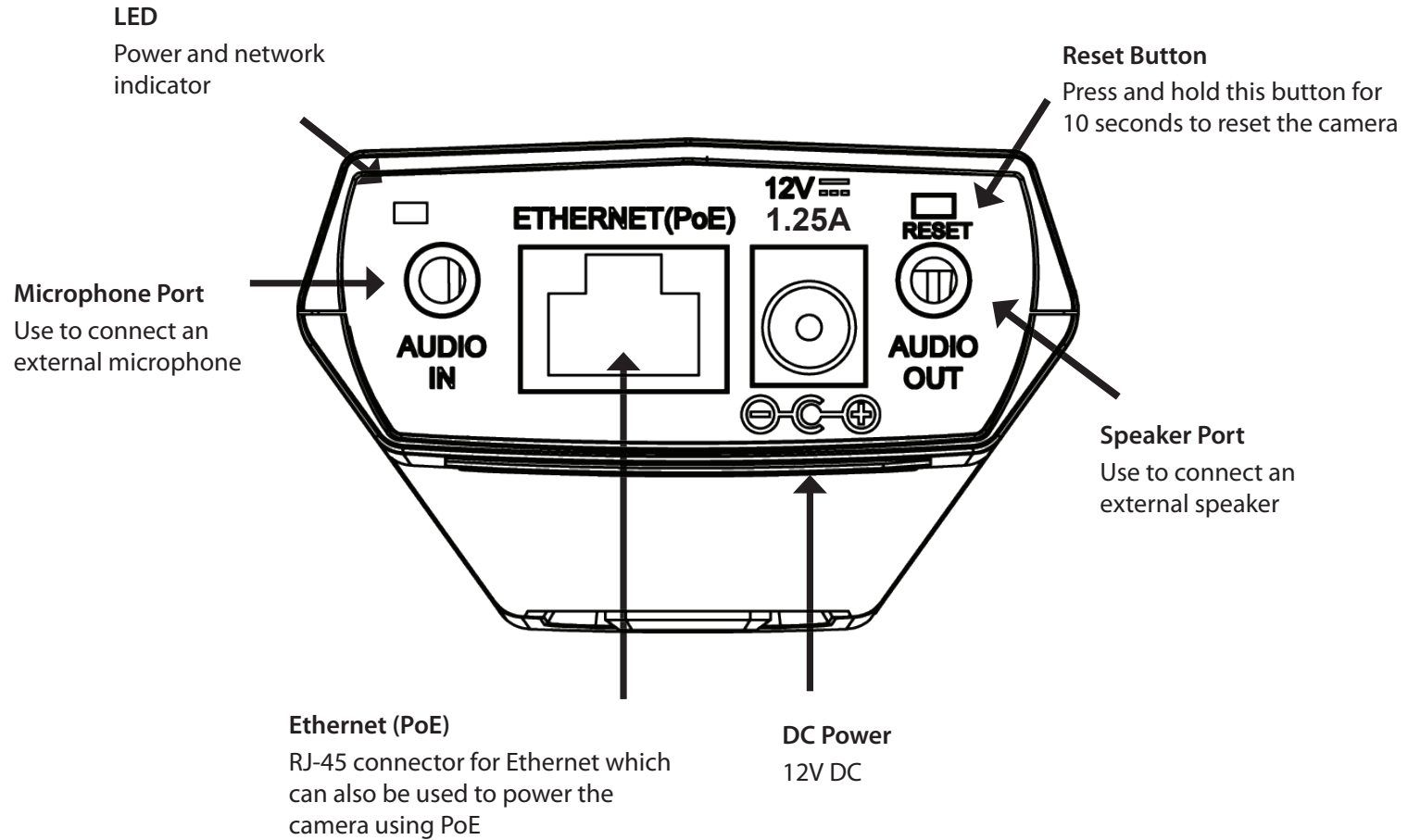

Side Panel

microSD Card Slot
Local microSD card for storing
recorded images and video

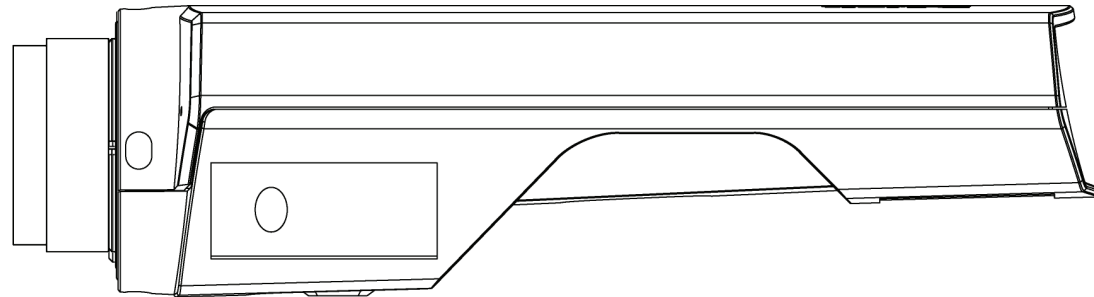
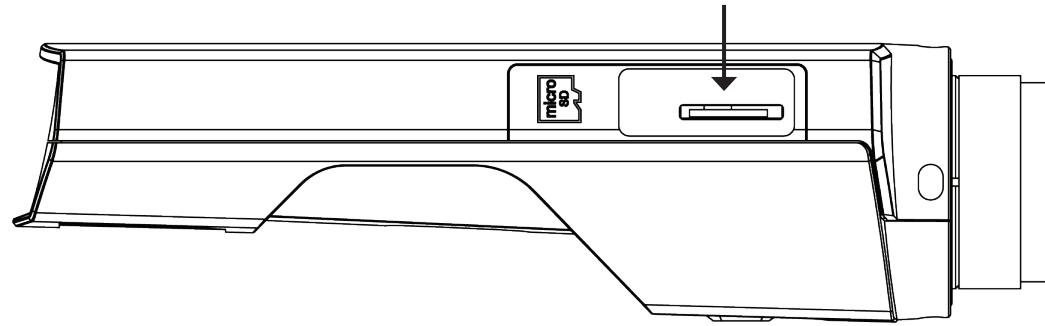

Button Panel

DC-Iris Connector
Connector for DC auto-iris lens

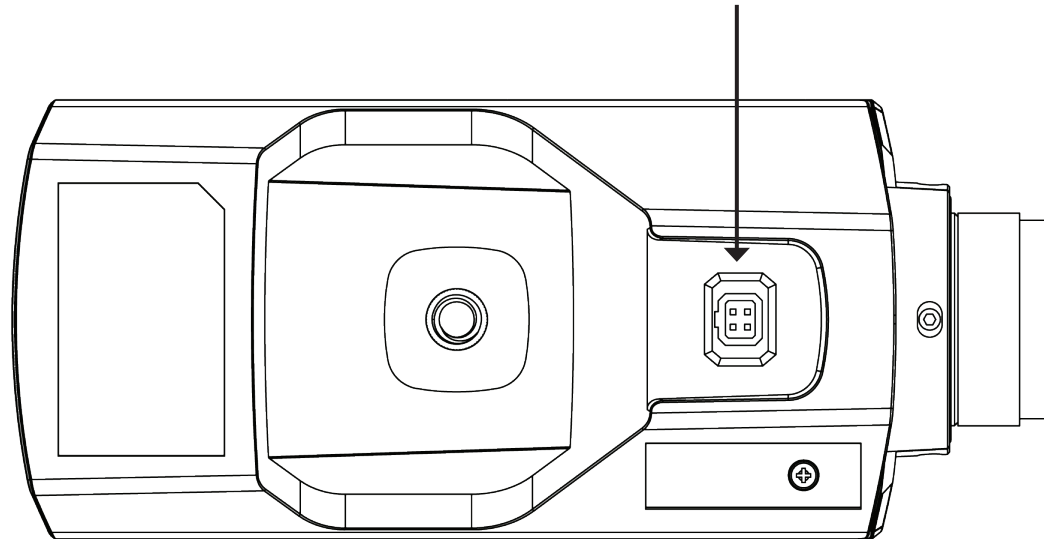

Hardware Installation

Basic Connection (without PoE)

Connect the camera to your switch or router via Ethernet cable.
Connect the supplied power cable from the camera to a power outlet.

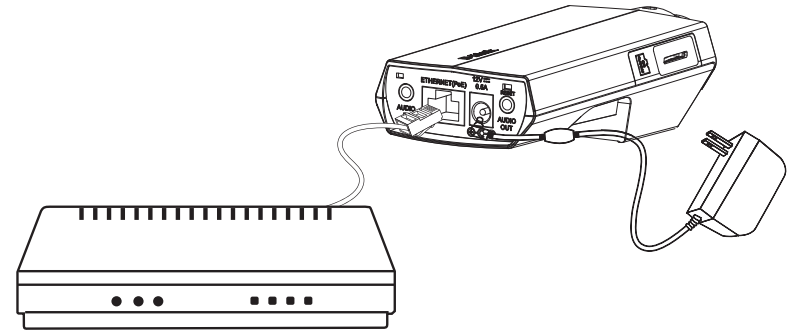

Connection Using a PoE Switch

If using a PoE switch or router, connect the network camera via Ethernet cable.
PoE will transmit both power and data over a single cable.

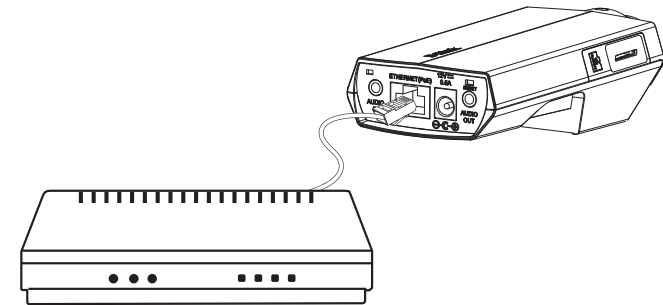

Note: Once power has been established, the LED will turn red. When the device has obtained an IP address and is accessible, the LED will turn green.

Configuration

Insert the DCS-3010 CD into your computer's CD-ROM drive to begin installation. If the *Autorun* function on your computer is disabled, or if the *D-Link Launcher* fails to start automatically, click **Start > Run**. Type **D:\autorun.exe**, where *D:* represents the drive letter of your CD-ROM drive.

Click **Setup Wizard** to begin the installation.

The following window will open.

Click **Next** to continue.

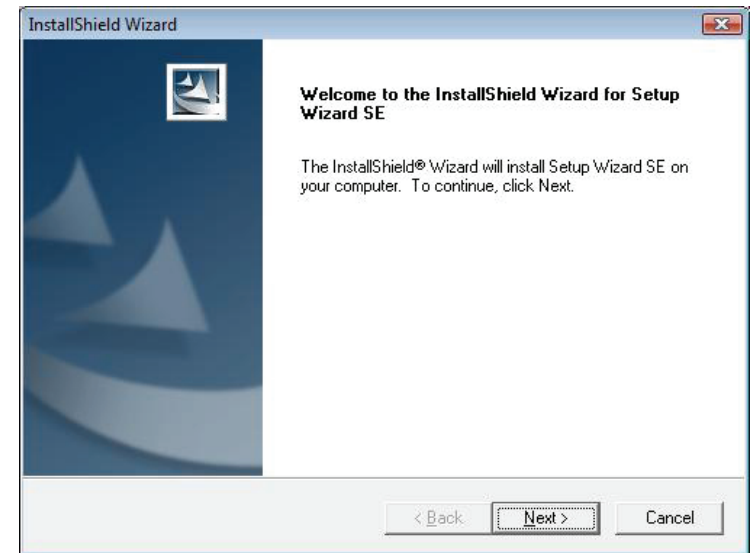

Click **Yes** to accept the License Agreement.

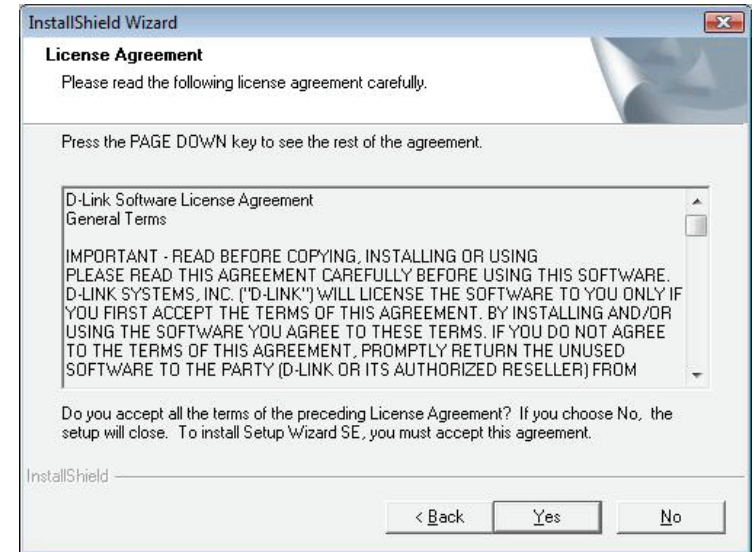

To start the installation process, click **Next**.

Note: *The installation may take several minutes to finish.*

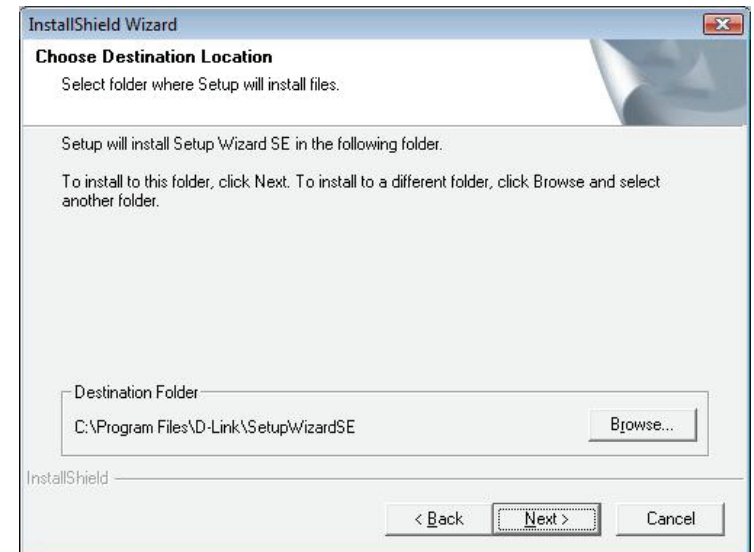

Click **Finish** to complete the installation.

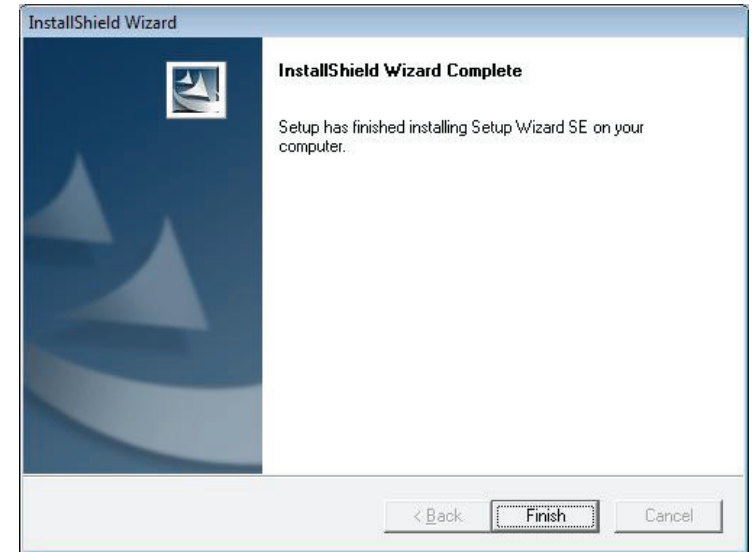

Click on the **D-Link Setup Wizard SE** icon that was created in your *Windows Start* menu.

Start > D-Link > Setup Wizard SE

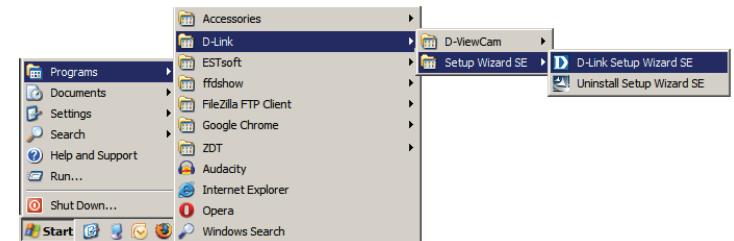

Configuration

The *Setup Wizard* will appear and display the MAC (Media Access Control) address and IP address of your camera(s). If you have a DHCP server on your network, a valid IP address will be displayed. If your network does not use a DHCP server, the network camera's default static IP, **192.168.0.20**, will be displayed.

Click the **Wizard** button to continue.

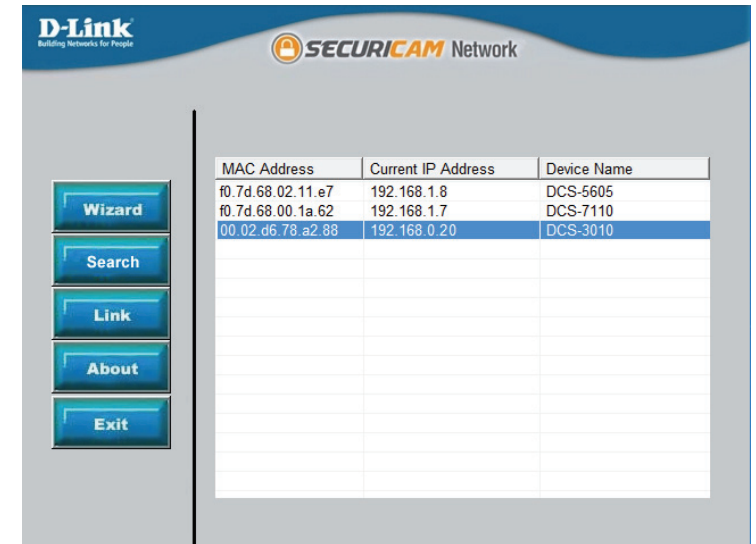

The screenshot shows the 'D-Link SECURICAM Network' interface. On the left, there is a vertical menu with buttons for 'Wizard', 'Search', 'Link', 'About', and 'Exit'. The main area displays a table with the following data:

MAC Address	Current IP Address	Device Name
f0.7d.68.02.11.e7	192.168.1.8	DCS-5605
f0.7d.68.00.1a.62	192.168.1.7	DCS-7110
00.02.d6.78.a2.88	192.168.0.20	DCS-3010

Enter the Admin ID and password. When logging in for the first time, the default Admin ID is "admin" and the password is left blank.

Click **Next**, to proceed to the next page.



The screenshot shows the 'D-Link SECURICAM Network' interface with the following text: 'Set up an Admin ID and Password to secure your camera. Click Next to continue.'

Admin ID Password

Change Change

New ID New Password

Reconfirm Reconfirm

Buttons: Back, Next, Exit

Select **DHCP** if your camera obtains an IP address automatically when it boots up.
Select **Static IP** if the camera will use the same IP address each time it is started.

Click **Next**, to proceed to the next page.

The screenshot shows the 'Set IP Address' configuration page. At the top, there is the D-Link logo and the Securicam Network logo. The page title is 'Set IP Address'. There are two radio buttons: 'DHCP' (selected) and 'Static IP'. Below these are input fields for IP Address (192.168.1.185), Subnet Mask (255.255.255.0), Default Gateway (192.168.1.1), Primary DNS (192.168.1.1), and Secondary DNS (192.168.1.1). At the bottom right, there are three buttons: 'Back' (left arrow), 'Next' (right arrow), and 'Exit' (power icon).

Take a moment to confirm your settings and click **Restart**.

The screenshot shows the 'Restart' configuration page. At the top, there is the D-Link logo and the Securicam Network logo. The page title is 'Restart'. There are input fields for Admin ID (admin), Password (empty), IP Address (192.168.0.102), Subnet Mask (255.255.255.0), Primary DNS (192.168.0.1), and Secondary DNS (192.168.0.1). Below these fields is a message: 'The Setup Wizard has completed. Click on 'Back' to modify your settings. Click 'Restart' to save your current settings and reboot the Internet Camera.' At the bottom right, there are two buttons: 'Back' (left arrow) and 'Restart' (refresh icon).

Viewing Camera via Web Browser

Click on the **D-Link Setup Wizard SE** icon that was created in your *Windows Start* menu.

Start > D-Link > Setup Wizard SE

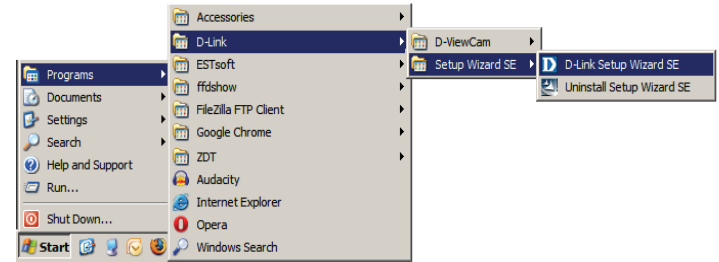

Select the camera and click the **Link** button to access the web configuration.

The *Setup Wizard* will automatically open your web browser to the IP address of the camera.

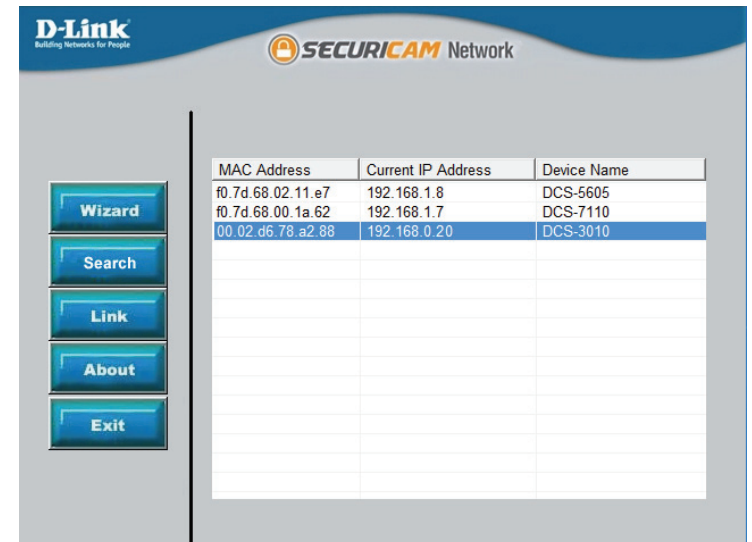

Enter **admin** as the default user name and leave the password blank. Click **OK** to continue.

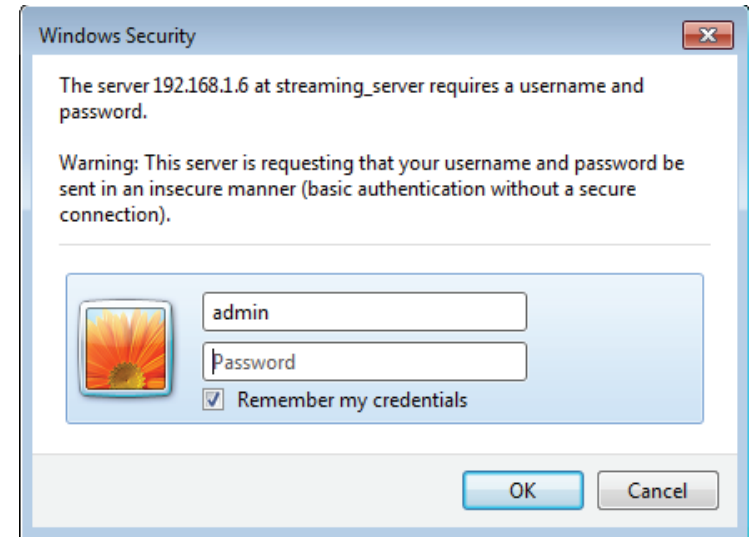

This section shows your camera's live video. You can select your video profile and view or operate the camera. For additional information about web configuration, please refer to the user manual included on the CD-ROM or the D-Link website.

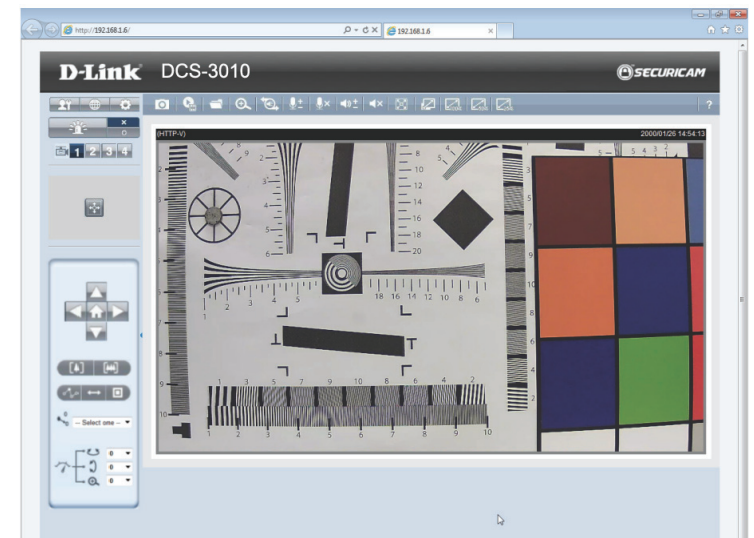

D-ViewCam Setup Wizard

D-ViewCam software is included for the administrator to manage multiple D-Link IP cameras remotely. You may use the software to configure all the advanced settings for your cameras. D-ViewCam is a comprehensive management tool for IP surveillance.

Insert the CD-ROM into the CD-ROM drive. A menu screen will appear as shown.

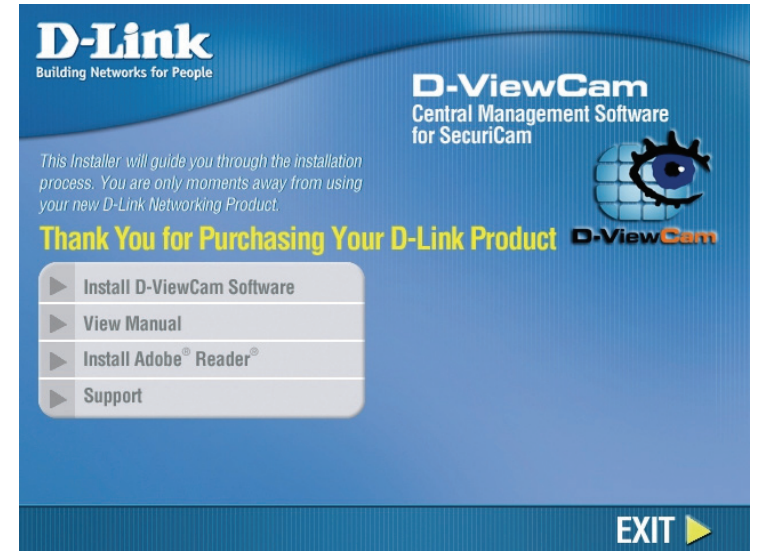

Follow the *Installation Wizard* to install *D-ViewCam*.

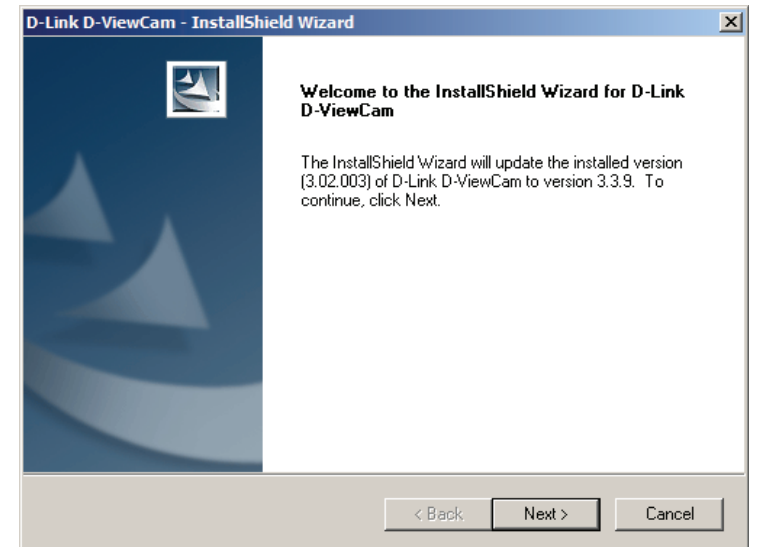

Click **Finish** to complete the installation.

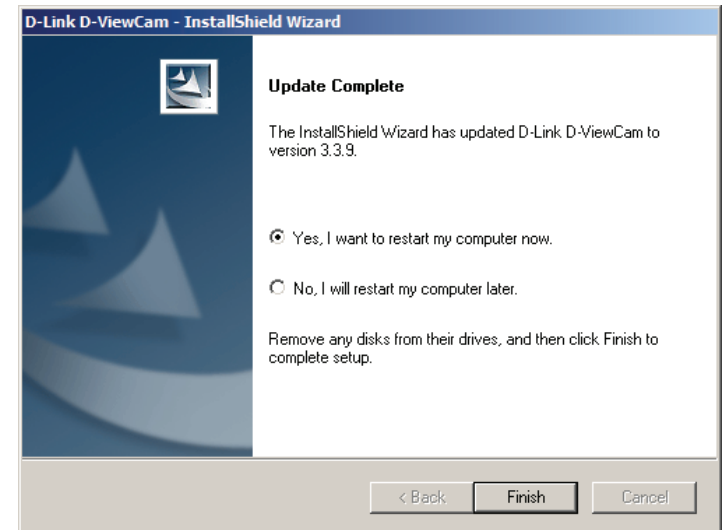

To start *D-ViewCam*, select **Start > All Programs > D-Link D-ViewCam > Main Console**.

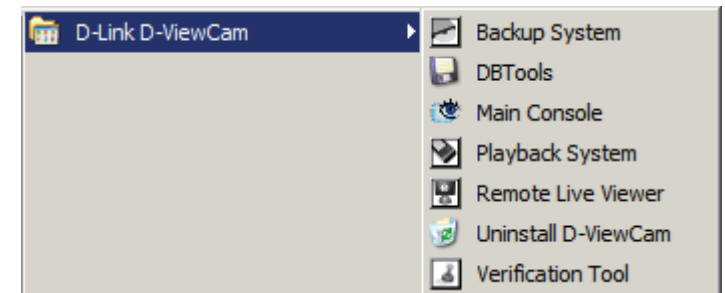







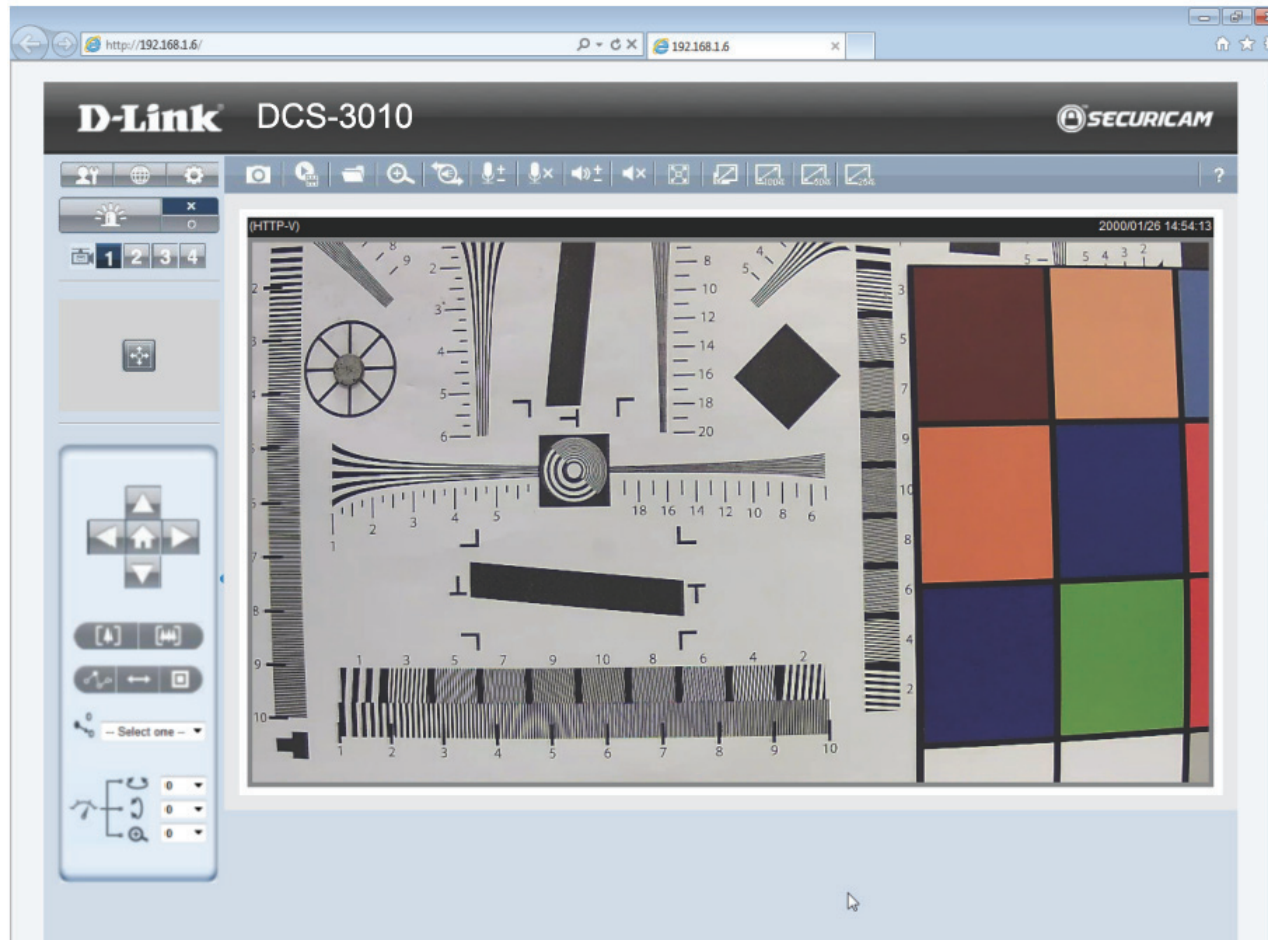

For more information about *D-ViewCam*, please refer to the documentation on the D-ViewCam CD-ROM.













Live Video

When you connect to the camera's web interface you will see the following page. This is the *Live Video* page which will allow you to view the camera's video feed and control basic camera functions using the icons on the screen. Please refer to the tables on the following pages for detailed information about the icons on this screen.



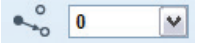
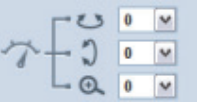







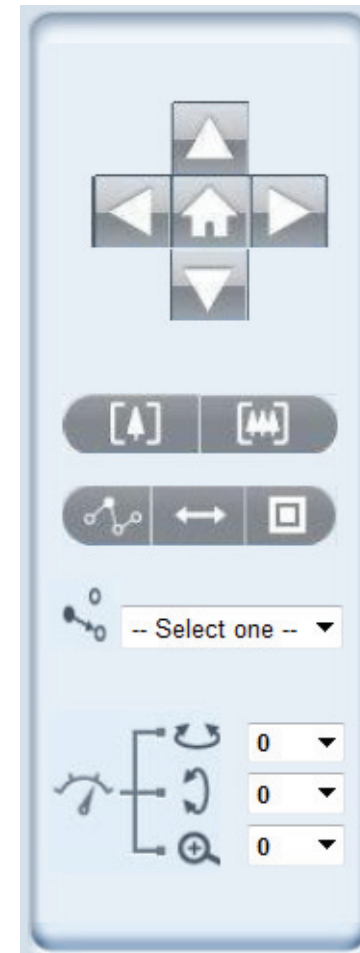





 <p>D-Link Logo</p>  <p>Securicam Logo</p>	<p>Click this logo to visit the D-Link website. The logos and website can be customized to fit your needs.</p>
 <p>Client Settings</p>	<p>Setup the stream transmission mode and saving options.</p>
 <p>Language</p>	<p>Select this option to change the language settings.</p>
 <p>Setup</p>	<p>Click on the Setup icon on the main page to enter the camera setting pages. Note that only Administrators can access the setup page. To simplify the setup procedure, two types of user interfaces are available: Advanced Setup for professional users and Basic Setup for entry-level users.</p>
 <p>Video Stream</p>	<p>This camera supports multiple streams (stream 1 ~ 4) simultaneously. You may select one for live viewing.</p>
 <p>Global View</p>	<p>Click on this icon to display the <i>Global View</i> window. The <i>Global View</i> window contains a full view image (the largest frame size of the captured video) and a floating frame (the viewing region of the current video stream). The floating frame allows users to control the <i>Digital PTZ</i> function (Digital Pan/Tilt/Zoom). For more information about Digital PTZ (also known as ePTZ) operation, please refer to <i>PTZ Control</i> on page 62. For more information about how to set up the viewing region of the current video stream, please refer to <i>Video Settings</i> on page 30.</p>



 <p>Digital PTZ Direction</p>	<p>This camera supports digital pan/tilt/zoom (Digital PTZ) control. Please refer to <i>PTZ Control</i> on page 62 for details information.</p> <p>Home: Move the camera to the preset home position.</p> <p>Direction: Control the camera's pan or tilt directions (up/down/left/right).</p>
 <p>Zoom</p>	<p>Zoom in/out to magnify or shrink the digital image.</p> <p> Zoom in: Magnify image</p> <p> Zoom out: Shrink image</p>
 <p>Patrol/Auto Pan</p>	<p> Patrol: <i>Patrol</i> executes a pre-defined sequence of pan, tilt, zoom, and focus features. Before selecting this, users must define at least two preset points.</p> <p> Auto Pan: <i>Auto Pan</i> automatically scans an area horizontally.</p>
 <p>Go To Preset</p>	<p>Select from the preset drop-down list to quickly move the camera to the desired preset position.</p>
 <p>Speed Control</p>	<p>Control Pan/Tilt/Zoom speed</p> <p> Pan Speed Control</p> <p> Tilt Speed Control</p> <p> Zoom Speed Control</p>

Digital PTZ Control Panel



<h1>Camera Control</h1> 	
 Snapshot	Click this button to capture and save still images. The captured images will be displayed in a pop-up window. Right-click the image and choose Save Picture As to save it in JPEG (*.jpg) or BMP (*.bmp) format.
 Recording	Click this button to record video clips to your computer. When you exit the web browser, video recording stops accordingly.
 Recording Folder	Specify a storage destination for the recorded video files.
 Digital Zoom	Click and uncheck "Disable digital zoom" to enable the <i>zoom</i> operation. The navigation screen indicates the part of the image being magnified. To control the zoom level, drag the slider bar. To move to a different area you want to magnify, drag the navigation screen.
 Talk	Talk/Stop Talk: Click this button to talk to people around the Network Camera if there is an external speaker connected to the camera and you have a microphone connected to your computer. Press the icon again to stop talking or disable this function.
 Microphone Level	Microphone Level: When the mute function is not active, move the slider bar to adjust the sensitivity level of the microphone (internal/external) that is connected to your network camera.
 Microphone Mute	Microphone Mute/Un-mute: Click to turn off the microphone (internal/external) that is connected to your network camera. Press again to turn the microphone back on.
 Speaker Volume	Speaker Volume: When the mute function is not active, move the slider bar to adjust the volume of the speakers that are connected to your network camera.
 Speaker Mute	Speaker Mute/Un-mute: Click to mute the external speaker that is connected to the network camera. Press again to un-mute the speaker.
 Full Screen	Click this button to switch to Full Screen mode. Click the "Esc" key to switch back to normal mode.
 Zoom Ratio	Auto: The video zoom ratio will be changed automatically according to viewing window size. 100%: Keep the video zoom ratio at 100% 50%: Keep the video zoom ratio at 50% 25%: Keep the video zoom ratio at 25%
 Help	Click the Help button to learn the detailed information regarding camera setup and solve any problems you encounter.

Client Setup

Clicking the **Client Settings** button  will bring you to the following screen which allows you to configure the basic protocol options for you camera.

H.264/MPEG4 Media Options

Video and Audio can be played at the same time or separately.

Recording Options

Folder: Select the folder where you would like the recording file saved on your computer.

File name prefix: Enter a file name prefix for the recording files.

Add date and time suffix to file name: Select this checkbox if you would like the date and time to be added to the end of each filename.

Local Streaming Buffer Time

Enter the buffer time in milliseconds. The buffer will cause a slight delay between live activity and the video of the live stream but may increase the quality of video.

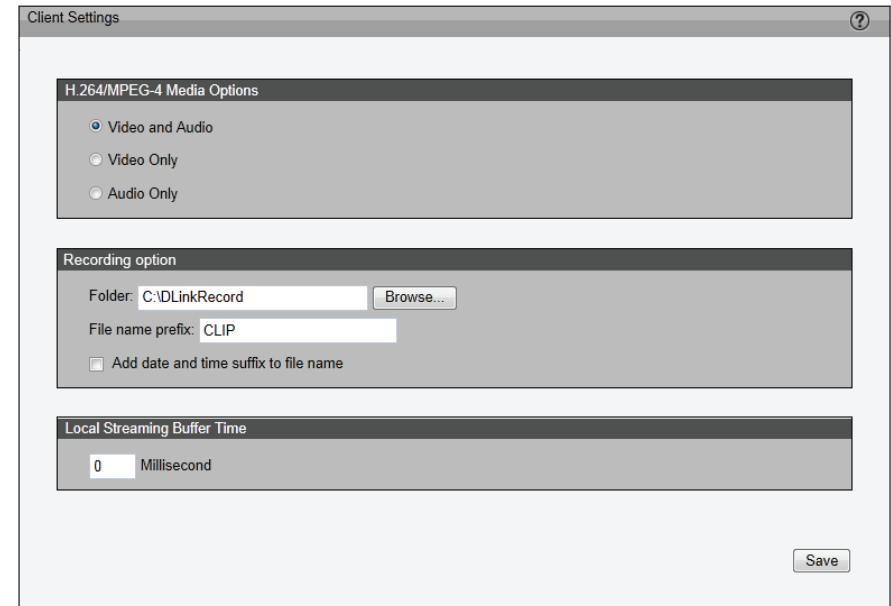

The screenshot shows the 'Client Settings' window with three main sections:

- H.264/MPEG-4 Media Options:** Contains three radio buttons: 'Video and Audio' (selected), 'Video Only', and 'Audio Only'.
- Recording option:** Includes a 'Folder:' text box with 'C:\DLinkRecord' and a 'Browse...' button, a 'File name prefix:' text box with 'CLIP', and a checkbox labeled 'Add date and time suffix to file name' which is currently unchecked.
- Local Streaming Buffer Time:** Features a text box with the value '0' and the label 'Millisecond'.

A 'Save' button is located in the bottom right corner of the window.

Setup

The DCS-3010 includes basic and advanced setup screens. Both screens include a tree view with multiple setup options. This manual includes detailed explanations for all advanced setup screens.

Basic Setup

Click the **Setup** button to enter the setup screen.



Click on the **Basic** button to enter the setup screen.



Click the [+] next to each folder to view the options.

Basic setup includes the following options:

System Overview

Audio and Video

- Video Settings, Audio Settings

Network

- IP Settings

Event Management

- Motion Detection, Tamper Detection

PTZ Control

-Digital PTZ

System

- User Settings, Device Settings, Time and Date, Maintenance

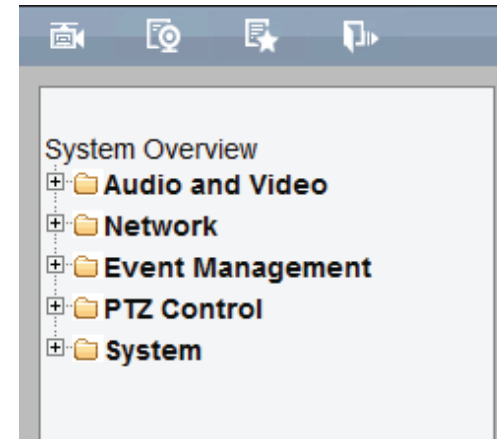

Advanced Setup

Click the **Setup** button to enter the setup screen.



Click on the **Advanced** button to enter the setup screen.



Please click the [+] next to each folder to view the options.

Advanced setup includes the following options:

System Overview

Audio and Video

- Video Settings, Image Settings, Audio Settings

Network

- IP Settings, Port & Access Name Settings, Dynamic DNS, HTTPS, Access List, Advanced Settings

Event Management

- Motion Detection, Tamper Detection, Event Settings

Recording

- Recording Settings, Local Storage

PTZ Control

-Digital PTZ

System

- User Settings, Device Settings, Time and Date, Maintenance, Parameter List, Logs

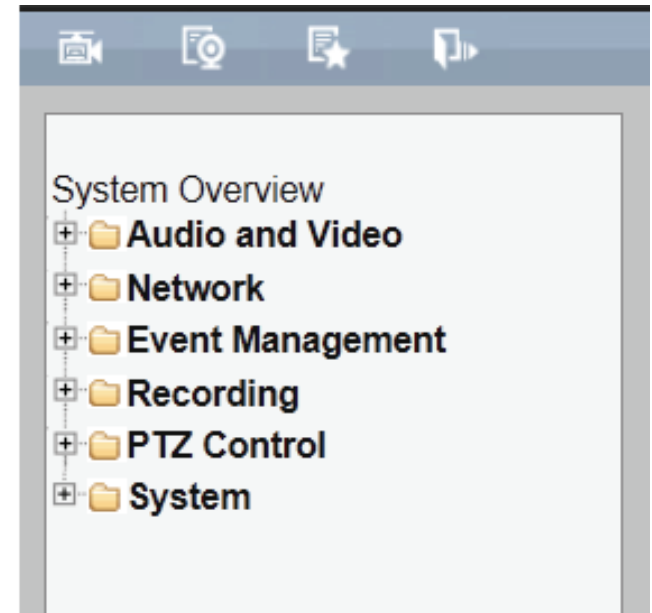

System Overview

The system overview page contains a summary of the camera's current settings. For more information about adjusting these settings please consult the subsequent instructions found in this manual.

D-Link DCS-3010 **SECURICAM**

192.168.1.6

System Overview

Device Information

IP address	192.168.1.6
Link-local address	169.254.0.99
Current firmware version	v1.00
Current firmware date	28 Apr 2011
MAC address	10.A9.55.66.77.89
Connect client	1

Time and Date

Current system time	23 Jan 2000 22:15:25
System up time	0 Days, 2 Hours, 8 Minutes
Time mode	Manually

Service Status

Service	Enabled / Disabled	Protocol	Server port
HTTP	Enable	TCP	80
Secondary HTTP	Enable	TCP	8080
HTTPS	Disable	TCP	443
FTP	Enable	TCP	21
RTSP	Enable	TCP	554
UPnP presentation	Enable	-	-
UPnP port forwarding	Disable	-	-
802.1x	Disable	-	-
COS	Disable	-	-
QoS / DSCP	Disable	-	-
SNMP	Disable	-	-
DDNS	Disable	-	-
Access list	Disable	-	-

Stream Status

Stream number	Codec type	Resolution	Max Frame Rate	Bitrate / Quality
Stream 1	H.264	1920x1080	30	Excellent
Stream 2	H.264	1280x720	30	3 Mbps
Stream 3	H.264	176x144	5	40 kbps
Stream 4	H.264	1920x1080	30	3 Mbps

Recent Logs

```

Jan 23 21:07:31 udhccp: router 192.168.1.1
Jan 23 21:07:32 udhccp: dns 192.168.1.1
Jan 23 21:18:32 [IR Cut Control]: Night mode
Jan 23 21:37:33 udhccp: IP 192.168.1.6 netmask 255.255.255.0
Jan 23 21:37:33 udhccp: router 192.168.1.1
Jan 23 21:37:33 udhccp: dns 192.168.1.1
Jan 23 22:07:34 udhccp: IP 192.168.1.6 netmask 255.255.255.0
Jan 23 22:07:34 udhccp: router 192.168.1.1
Jan 23 22:07:34 udhccp: dns 192.168.1.1
Jan 23 22:07:50 [IR Cut Control]: Day mode
    
```

Video

Video Settings

This page allows you to set up 4 video streams to be displayed on a computer, mobile device, or saved on a storage system. Each stream has independent options for proper compression type, frame size and frame rate to optimize bandwidth utilization and video quality.

Video Options

Viewing Window: The camera supports multiple streams with frame size ranging from 176x144 to 1280x800. Click **Viewing Window** to open the viewing region setting page. On this page, you can set the **Region of Interest (ROI)** and the **Output Frame Size** for stream 1~3. Please follow the steps below to set up a stream:

1. Select a stream whose viewing region you would like to set.
2. Select a **Region of Interest** from the drop-down list; the floating frame will re-size accordingly. If you want to set up a customized viewing region, you can also re-size and drag the floating frame to a desired position with your mouse.
3. Choose a proper **Output Frame Size** from the drop-down list according to the size of your monitoring device.

Note: All the items in the **Output Frame Size** should not be greater than the **Region of Interest** (current maximum resolution).

The definition of multiple streams:

Stream 1-3: Users can define the **Region of Interest** (viewing region) and the **Output Frame Rate** (size of the live view window).

Stream 4: This is global view stream which captures the full view of the video. Users can also define the **Output Frame Rate** (size of the live view window).

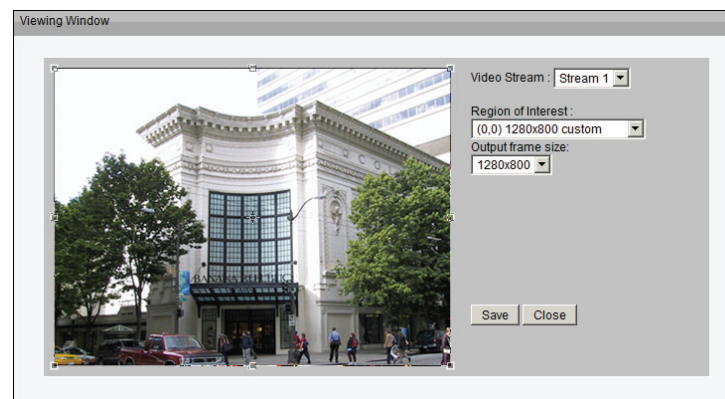
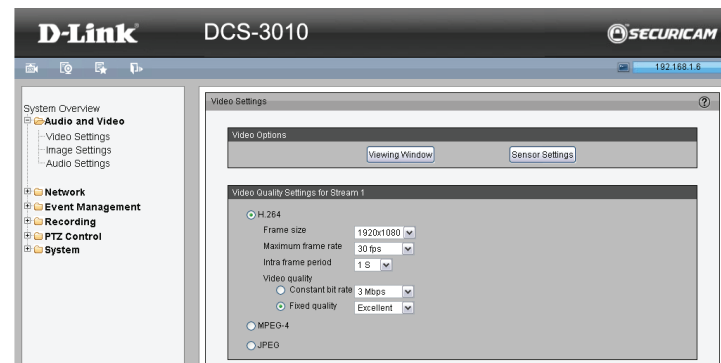

Once you are finished with the settings in the *Viewing Window*, click **Save** to enable the settings and click **Close** to exit the window. The selected **Output Frame Size** will immediately be applied to the frame size of the video stream. You can then go back to the *Live Video* to test the new settings.

Sensor Setting: Click **Sensor Setting** to open the options page. On this page, you can set the maximum exposure time, exposure level and **AGC (Auto Gain Control)** settings. You can configure two sets of sensor settings: one for normal situations (Profile 1), the other for special situations such as **Day/Night/Schedule mode** (Profile 2).

Exposure

- **Maximum Exposure Time:** Select a proper maximum exposure time according to the light source of the surroundings. Shorter exposure times result in less light reaching the sensor. The exposure times are selectable for the following durations: **1/5, 1/15, 1/30, 1/60, 1/120, 1/240, 1/480**.
- **Exposure level:** You can manually set the exposure level, which ranges from 1 to 8 (dark to bright).
- **Max. Gain (Auto Gain Control):** You can manually set the **AGC** level (**2x, 4x, 8x, 16x, 32x**). The higher the value, the brighter the image will be.
- **Enable BLC (Back Light Compensation):** Enable this option when the object is too dark or too bright to recognize. It allows the camera to adjust to the best light conditions in any environment and automatically give the necessary light compensation.

You may click **Preview** to fine-tune the image, or click **Restore** to recall the original setting without incorporating the changes. When completed, click **Save** to enable the setting and click **Close** to exit the page. If you want to configure another sensor setting for **Day/Night/Schedule mode**, please click **Profile 2** and follow the steps below to setup:

1. Click **Enable** to activate this profile.
2. Select the applied mode: **Day mode**, **Night mode**, or **Schedule mode**. Please manually enter a range of time if you choose **Schedule mode**.
3. Configure **Exposure settings** and configure **Image settings** in the third column.
4. Click **Save** to enable the settings and click **Close** to exit the page.

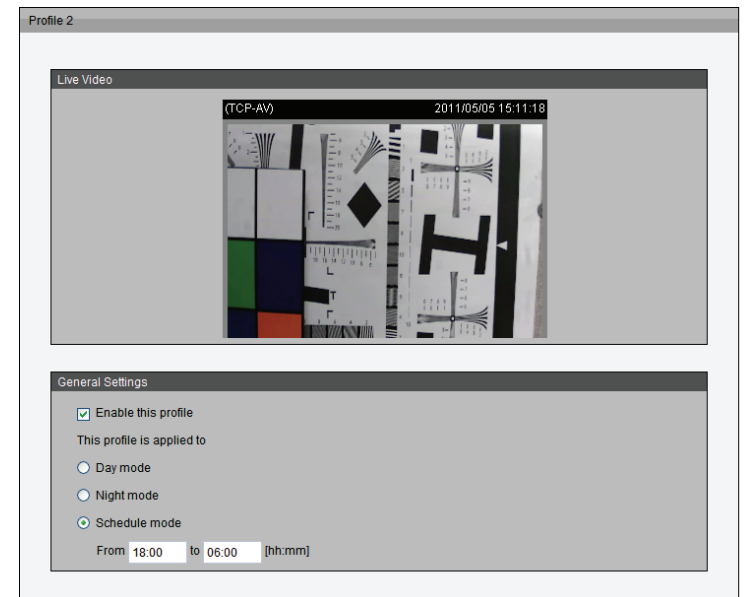

Video Quality Setting for Stream 1~4

Compression Type: The compression level affects the amount of bandwidth and storage required. Lower compression uses more bandwidth and storage but delivers better image quality. Of the three options, **H.264** consumes much less network bandwidth compared to **MPEG4** and **JPEG**.

Frame Size: Select proper frame size for different viewing devices. Bigger frame size requires more bandwidth and storage usage. For smaller viewers, such as mobile phones, a smaller frame size and lower frame rate is recommended. There are six options you can select: **320x200**, **640x400**, **1280x800**, if there is no viewing window applied. (**176x144** for mobile phone, **1280x720**).

Frame Rate: This option affects the smoothness of the video. Higher frame rate produces smoother video quality but it requires more storage space. There are 11 options: **customize**, **1**, **2**, **3**, **5**, **8**, **10**, **15**, **20**, **25**, and **30 fps** (30 fps is recommended real-time video on a computer monitor. 5 fps is ideal for mobile viewers).

Intra Frame Period: Determines the frequency and I frame is planted. The shorter the duration the more likely you will get better video quality, but at the cost of higher network bandwidth consumption. Select the **Intra Frame Period** from the following durations: **1/4 second**, **1/2 second**, **1 second**, **2 seconds**, **3 seconds** and **4 seconds**.

Video Quality: This setting limits the maximum refresh frame rate.

- **Constant bit rate:** To set a fixed bandwidth regardless of the video quality, select **Constant bit rate** and the desired bandwidth from **20 Kbps** to **8 Mbps**.
- **Fixed quality:** Optimizes the bandwidth utilization and video quality. The video quality can be adjusted to the following settings: **Medium**, **Standard**, **Good**, **Detailed** and **Excellent**.

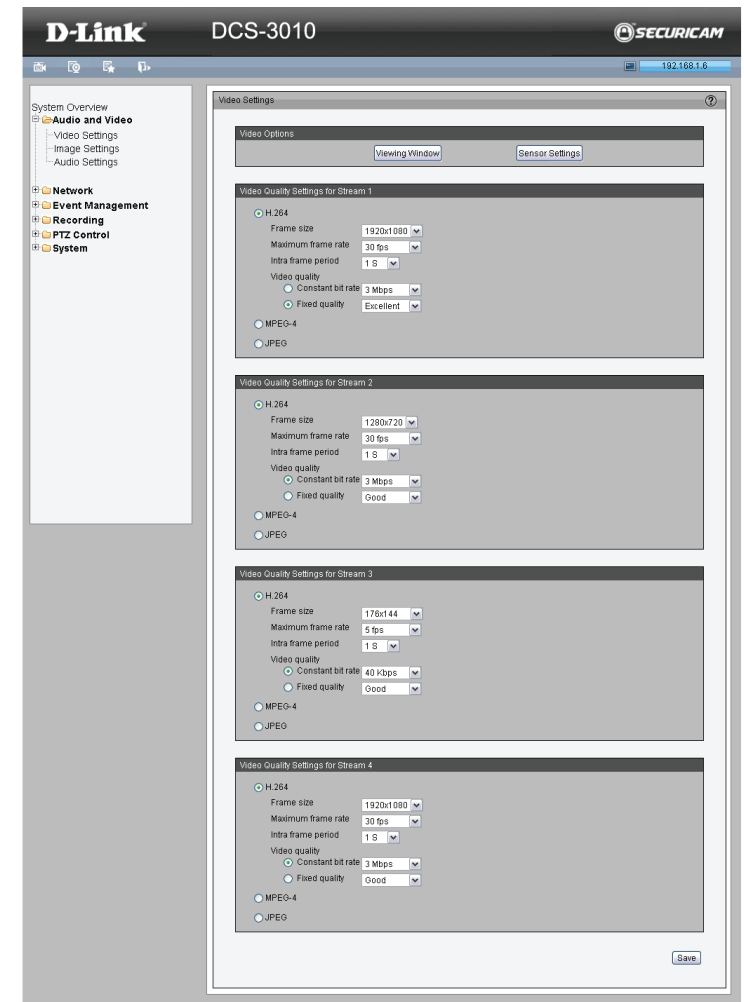

Image Settings

This page allows you to tune the white balance, brightness, saturation, contrast, and sharpness settings for the video.

Color: Select either a **Color** or **B/W** (black and white, monochrome) video display.

Power Line Frequency: Select either **50Hz** or **60Hz** depending on your region.

Iris mode: **fixed**, **indoor** or **outdoor**

Video Orientation: **Flip** will vertically rotate the video. **Mirror** will horizontally rotate the video. You may select both options if camera is being installed upside down.

White Balance: This adjusts the relative amount of red, green and blue primary colors in the image so that the neutral colors are reproduced correctly.

- **Auto:** The camera automatically adjusts the color temperature of the light in response to different light sources. The white balance setting defaults to **Auto** and works well in most situations.
- **Fixed:** Follow the steps below to manually set the white balance to compensate for the ambient lighting conditions

1. Set the **White balance** to **Auto** and click **Save**.
2. Place a sheet of white paper in front of the lens, then allow the camera to adjust the color temperature automatically.
3. Select **Fixed** to confirm the setting while the white balance is being measured.
4. Click **Save** to enable the new setting.

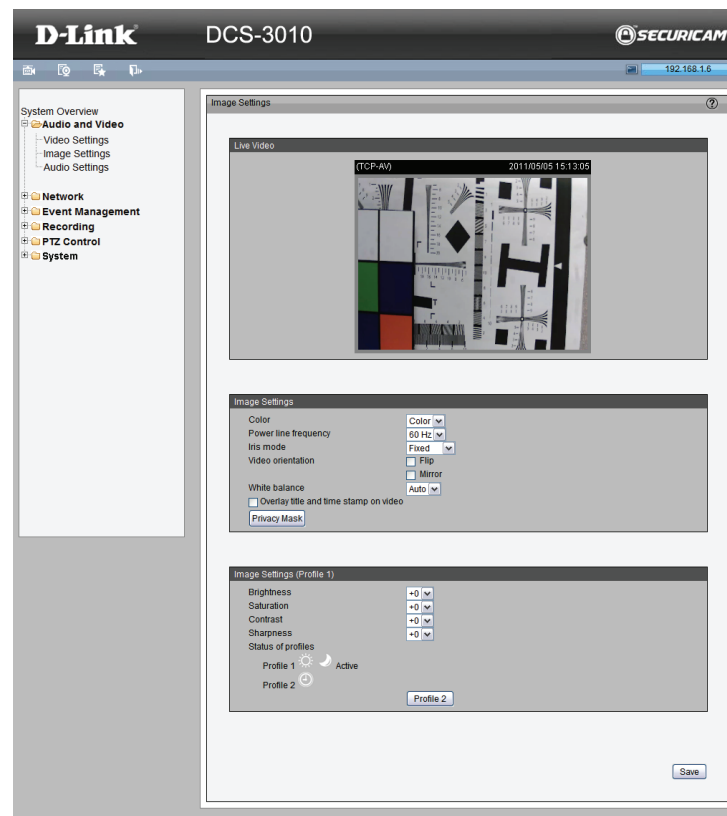

Brightness: Adjust the image brightness level, which ranges from **-5** to **+5**.

Saturation: Adjust the image saturation level, which ranges from **-5** to **+5**.

Contrast: Adjust the image contrast level, which ranges from **-5** to **+5**.

Sharpness: Adjust the image sharpness level, which ranges from **-3** to **+3**.

Overlay Title and Time Stamp on Video: Select this option to place the video title and time on the video streams. (When the frame size is set to 176x144, only the time will be stamped on the video streams.)

Note: The **Sensor Settings** and **Image Settings** share the same **Profile 2** settings.

Privacy Mask: In this page, you can block out certain sensitive zones for privacy concerns. To set up a *Privacy Mask Window*, follow the steps given below:

1. Click **New** to add a window.
2. Adjust the dimensions of the privacy window and drag to the area of the camera view you want to block out.
3. Enter a descriptive Window Name and click **Save** to apply changes.
4. Select **Enable privacy mask** to facilitate this function.

Note:

- *Up to five Privacy Mask Windows can be set up on the same screen.*
- *If you want to delete the privacy mask window, please click the 'X' at the upper right-hand corner of the window.*

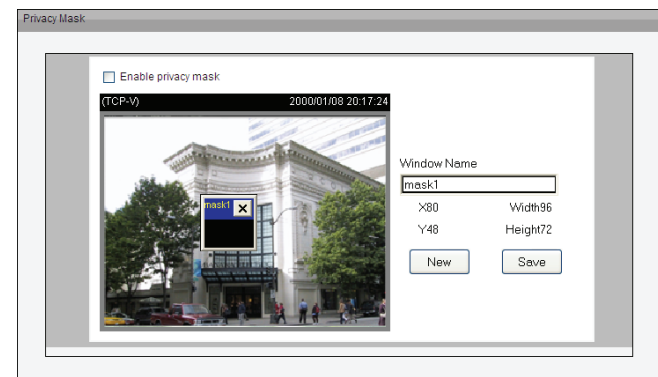
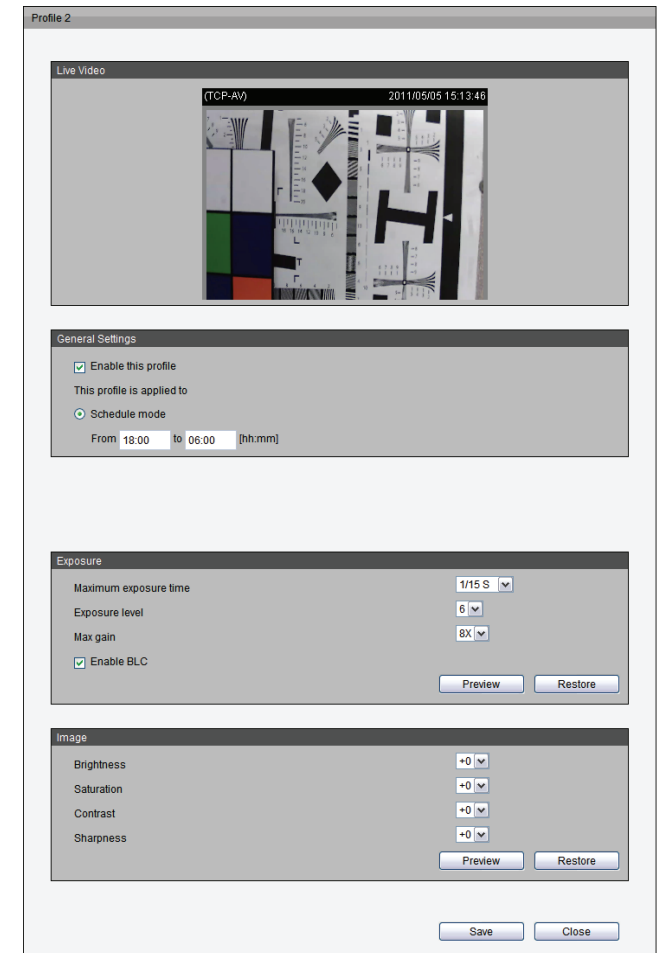

Audio Settings

Mute: Select to mute audio.

Microphone input gain: It is necessary to find the optimum gain between **-15dB** to **+15dB** that transmits the best audio for listening.

Audio type: Advanced Audio Coding (AAC) is a wide band audio coding algorithm that exploits two primary coding strategies to dramatically reduce the amount of data needed to convey high-quality digital audio. Select a higher bit rate number for better audio quality.

AAC bit rate: Select an AAC bit rate from the drop-down list. Higher bit rate means higher audio quality but it takes more network bandwidth to transmit.

GSM-AMR: A standard adapted audio codec by the 3GPP video (3rd Generation Partnership Project). It is an Adaptive Multi Rate-Narrow Band (AMRNB) speech codec. Select a higher bit rate number for better audio quality.

GSM-AMR bit rate: Select the GSM-AMR bit rate from the drop-down list. Higher bit rate means higher audio quality but it takes more network bandwidth to transmit.

G711 bit rate: Select an G711 bit rate from the drop-down list. Higher bit rate means higher audio quality but it takes more network bandwidth to transmit.

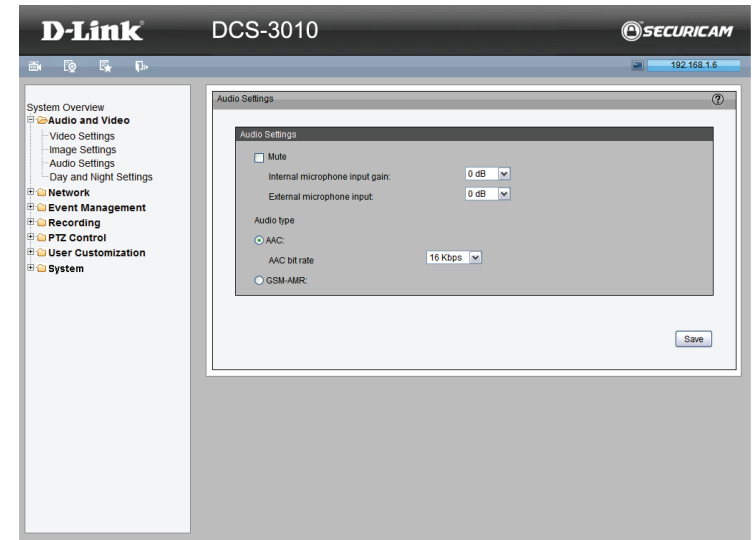

Network

IP Settings

IPv4

LAN: Select this option when the camera is deployed on a local area network (LAN) and is intended to be accessed by local computers. The default setting for the Network Type is **LAN**. Remember to click **Save** when you complete the Network setting.

- **Get IP address automatically (DHCP):** Select this connection if you have a DHCP server running on your network and would like a dynamic IP address to be assigned to the camera automatically.
- **Use fixed IP address:** You may enter a static or fixed IP address for your camera.

IP Address: Enter an IP address.

Subnet Mask: The default value is “**255.255.255.0**.”

Default Router: This is the gateway used to forward frames to destinations in a different subnet. (Invalid router setting will cause the transmission to fail if its destination is in a different subnet).

Primary DNS: The Primary Domain Name Server (DNS) that translates host name into IP address.

Secondary DNS: Secondary Domain Name Server (DNS) that backups the Primary DNS.

Primary WINS Server: The primary WINS server that maintains the database of computer name and IP address.

Secondary WINS Server: The secondary WINS server that maintains the database of computer name and IP address.

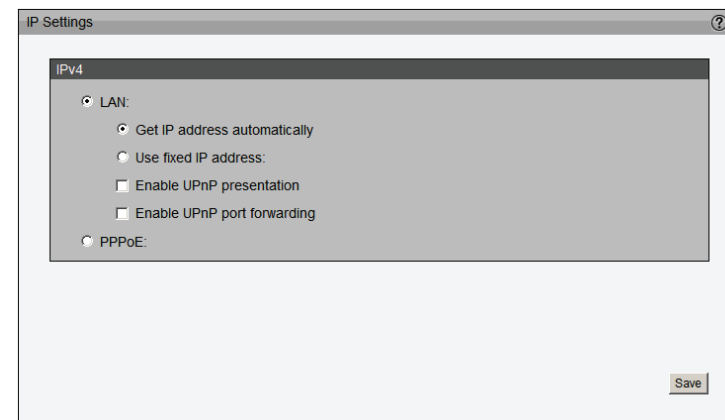

The screenshot shows the 'IP Settings' window with the 'IPv4' tab selected. Under the 'LAN' section, the 'Get IP address automatically' option is selected. Other options include 'Use fixed IP address', 'Enable UPnP presentation', and 'Enable UPnP port forwarding'. The 'PPPoE' option is also visible but not selected. A 'Save' button is located at the bottom right.

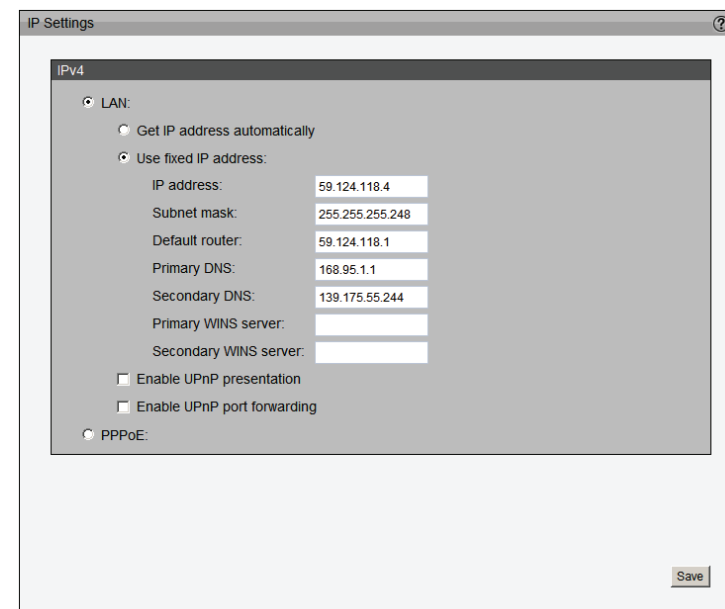

The screenshot shows the 'IP Settings' window with the 'IPv4' tab selected. Under the 'LAN' section, the 'Use fixed IP address' option is selected. The following fields are filled in: IP address: 59.124.118.4, Subnet mask: 255.255.255.248, Default router: 59.124.118.1, Primary DNS: 168.95.1.1, and Secondary DNS: 139.175.55.244. The 'Enable UPnP presentation' and 'Enable UPnP port forwarding' options are unchecked. The 'PPPoE' option is also visible but not selected. A 'Save' button is located at the bottom right.

- **Enable UPnP Presentation:** Select this option to enable *UPnP* presentation for the camera so that whenever a camera is presented to the LAN, shortcuts of connected cameras will be listed in *My Network Places*. You can click the shortcut to link to the web browser.

Note: For Windows® XP or later, to utilize this feature, please make sure the UPnP component is installed on your computer.

- **Enable UPnP Port Forwarding:** To access the camera from the Internet, select this option to allow the camera to open ports on the router automatically so that video streams can be sent out from a LAN. To utilize this feature, make sure that your router supports UPnP and it is activated.

How does UPnP work?

UPnP networking technology provides automatic IP configuration and dynamic discovery of devices added to a network. Services and capabilities offered by networked devices, such as printing and file sharing, are available among each other without bothersome network configuration. You will see *Network Camera* shortcuts at *My Network Places*.

PPPoE: Select this option to configure the camera to make it accessible from anywhere with an Internet connection. Note that to utilize this feature, it requires an account provided by your ISP.

Follow the steps below to acquire the camera's public IP address.

1. Set up the camera on the LAN
2. Go to **Live View > Setup > Event management > Event settings > Server Settings** (please refer to *Server Settings* on page 52 to add a new e-mail or FTP server)
3. Go to **Setup > Event management > Event settings > Media Settings** (please refer to *Media Settings* on page 54). Select **System log** so that you will receive the system log in TXT file format, which contains the camera's public IP address, in your e-mail or on the FTP server.

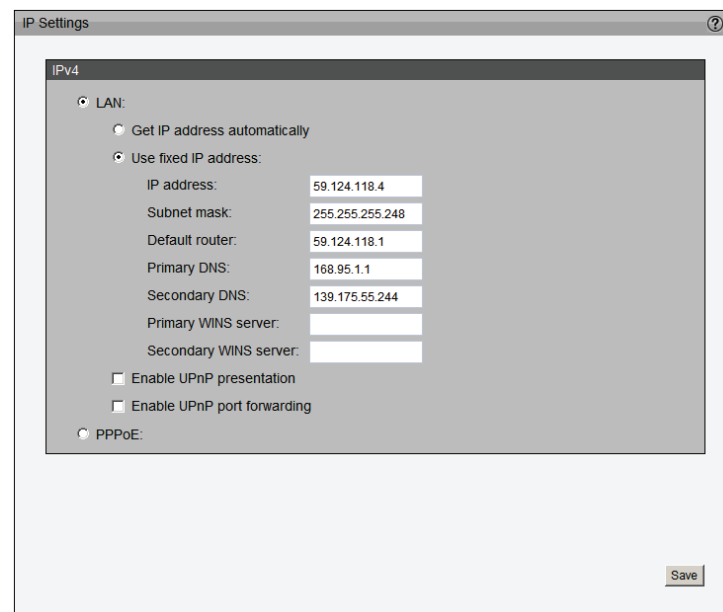

The screenshot shows the 'IP Settings' window with the 'IPv4' tab selected. Under the 'LAN' section, the 'Use fixed IP address' option is selected. The fields are filled with: IP address: 59.124.118.4, Subnet mask: 255.255.255.248, Default router: 59.124.118.1, Primary DNS: 168.95.1.1, and Secondary DNS: 139.175.55.244. The 'Enable UPnP presentation' and 'Enable UPnP port forwarding' checkboxes are unchecked. The 'PPPoE' option is not selected. A 'Save' button is visible at the bottom right.



The screenshot shows the 'IP Settings' window with the 'IPv4' tab selected. Under the 'LAN' section, the 'PPPoE' option is selected. The fields are filled with: User name: 123456@hinet.net, Password: [masked with dots], and Confirm password: [masked with dots].

4. Go to **Setup > Network > IP settings**. Select **PPPoE** and enter the user name and password provided by your ISP. Click **Save** to enable the setting.
5. The camera will reboot.
6. Disconnect the power to the camera. Remove it from the LAN environment.

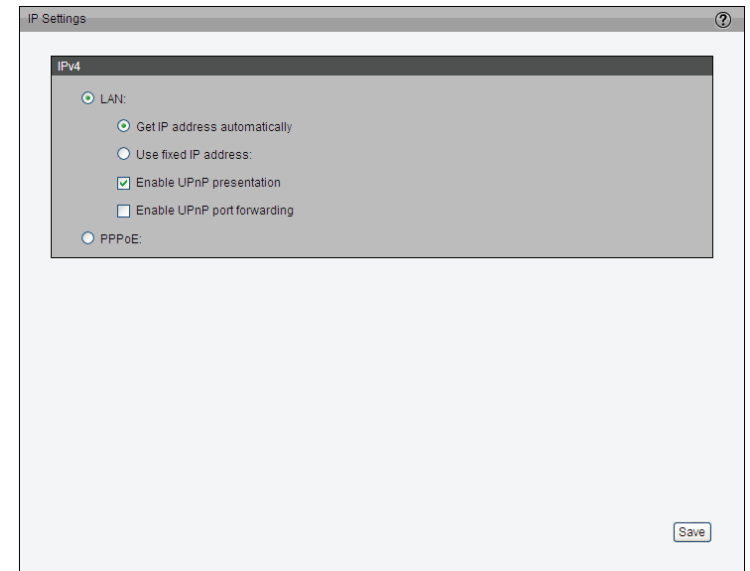

Port and Access Name Settings

HTTPS

By default, the HTTPS port is set to 443. It can also be assigned to another port number between 1025 and 65535.

Note: JPEG only transmits a series of JPEG images to the client. In order to utilize this audio feature, make sure the video mode is set to **H.264** or **MPEG-4** and the media option in "Client Settings" is set to **Video and Audio**.

FTP

The FTP server allows the user to save recorded video clips. You can utilize D-Link's *IP Cam Wizard* to upgrade the firmware via FTP server. By default, the FTP port is set to 21. It also can be assigned to another port number between 1025 and 65535.

HTTP port/Secondary HTTP port

They can also be assigned to another port number between 1025 and 65535. To access the Network Camera on the LAN, both the HTTP port and secondary HTTP port can be used to access the Network Camera. For example, when the HTTP port is set to 80 and the secondary HTTP port is set to 8080. You can login camera as example link as below:

Http://192.168.0.20 or

Http://192.168.0.20:8080

Authentication: Depending on your network security requirements, the Network Camera provides three types of security settings for streaming via HTTP protocol: **disable**, **basic**, and **digest**. If **basic** authentication is selected, the password is sent in plain text format, but there can be potential risks of it being intercepted. If **digest** authentication is selected, user credentials are encrypted using MD5 algorithm, thus providing better protection against unauthorized access.

Access name for stream 1 ~ 4: This Network Camera supports multiple streams simultaneously. The access name is used to differentiate the streaming source.

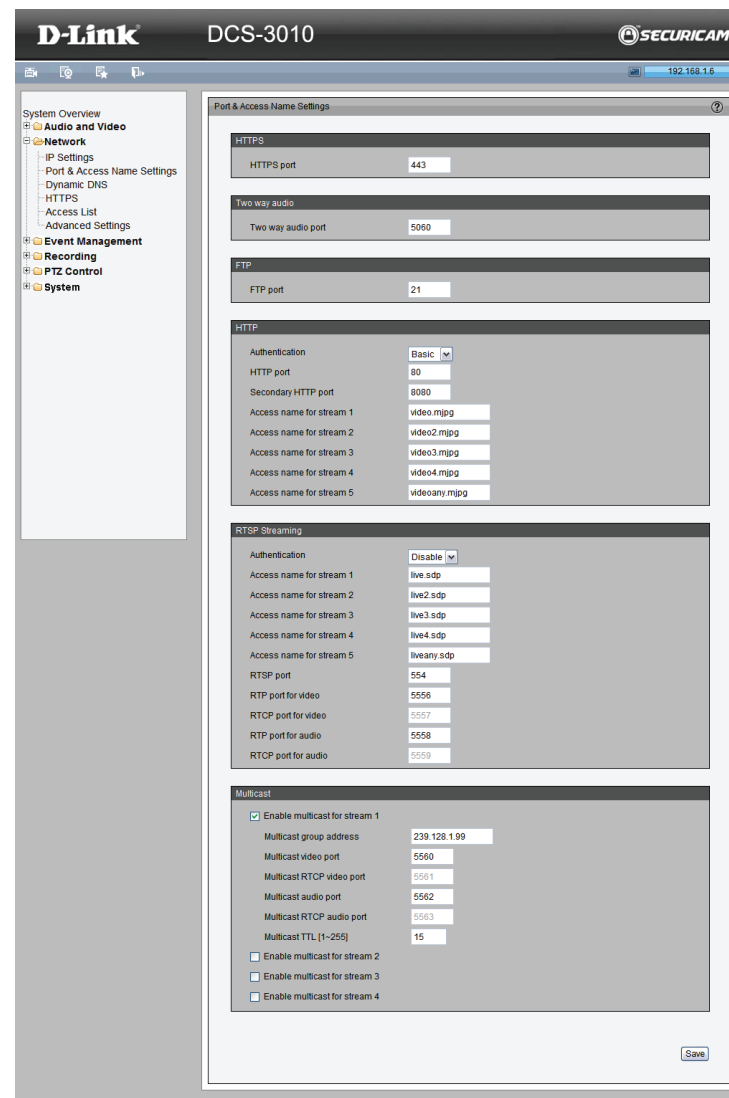

When using Mozilla Firefox or Netscape to access the Network Camera and the video mode is set to JPEG, users will receive video comprised of continuous JPEG images. This technology, known as “server push”, allows the Network Camera to feed live pictures to Mozilla Firefox and Netscape. Use the following HTTP URL command to request transmission of the streaming data:

http://<ip address>:<http port>/<access name for stream 1 ~ 4>

For example, when the access name for stream 3 is set to *video3.mjpg*:

1. Launch Mozilla Firefox or Netscape.
2. Type the above URL command in the address bar. Press Enter.
3. The JPEG images will be displayed in your web browser.

Note: Microsoft® Internet Explorer does not support server push technology; therefore, using the above command line will fail to access the Network Camera.

RTSP Streaming

Authentication: Depending on your network security requirements, the Network Camera provides three types of security settings for streaming via RTSP protocol: **disable**, **basic**, and **digest**. If **basic** authentication is selected, the password is sent in plain text format, but there can be potential risks of it being intercepted. If **digest** authentication is selected, user credentials are encrypted using MD5 algorithm, thus providing better protection against unauthorized access.

Access name for stream 1 ~ 4: The Network Camera supports multiple streams simultaneously. The access name is used to differentiate the streaming source. If you want to use an RTSP player to access the Network Camera, you have to set the video mode to **H.264 / MPEG-4**.

RTSP port: RTSP (Real-Time Streaming Protocol) controls the delivery of streaming media. By default, the port number is set to **554**.

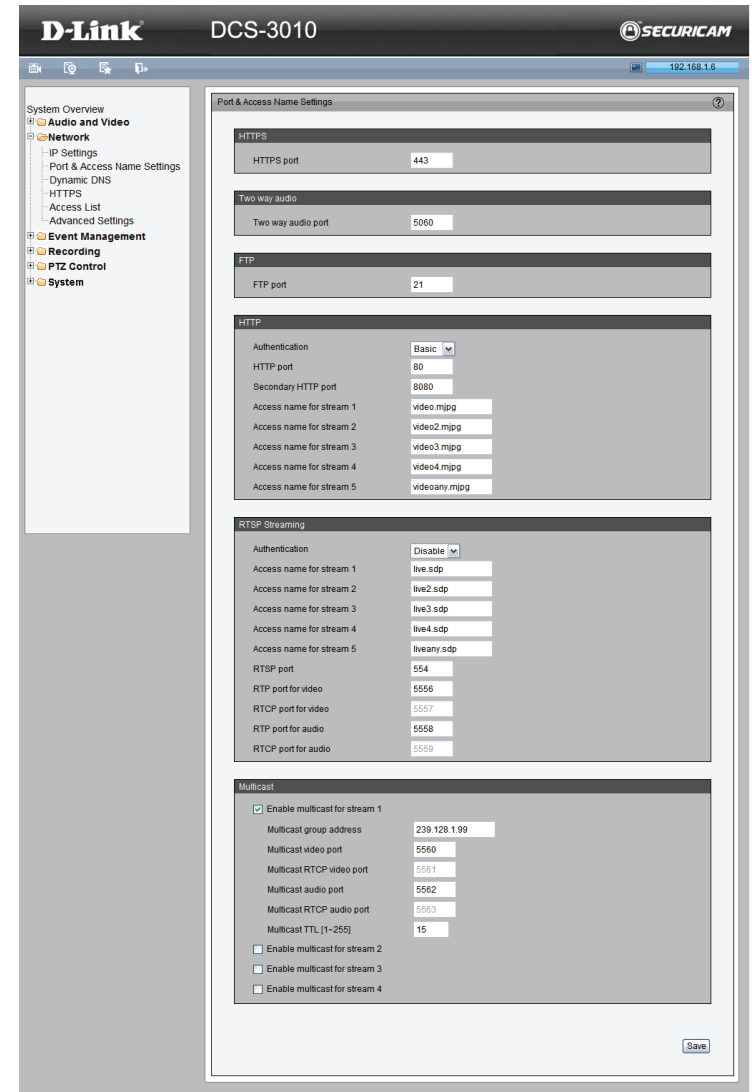

RTP port for video, audio: The RTP (Real-time Transport Protocol) is used to deliver video and audio data to the clients. By default, the RTP port for video is set to **5556** and the RTP port for audio is set to **5558**.

RTCP port for video, audio: The RTCP (Real-time Transport Control Protocol) allows the Network Camera to transmit the data by monitoring the Internet traffic volume. By default, the RTCP port for video is set to **5557** and the RTCP port for audio is set to **5559**.

The ports can be changed to values between 1025 and 65535. The RTP port must be an even number and the RTCP port is the RTP port number plus one, and thus is always an odd number. When the RTP port changes, the RTCP port will change accordingly.

Multicast

Click the items to display the detailed configuration information.

Unicast video transmission delivers a stream through point-to-point transmission. *Multicast*, on the other hand, sends a stream to the multicast group address and allows multiple clients to acquire the stream at the same time by requesting a copy from the multicast group address. Therefore, enabling multicast can effectively save network bandwidth.

Multicast RTP video, audio port/ Multicast RTCP video, audio port: The ports can be changed to values between 1025 and 65535. The multicast RTP port must be an even number and the multicast RTCP port number is the multicast RTP port number plus one, and thus is always odd. When the multicast RTP port changes, the multicast RTCP port will change accordingly.

Multicast TTL [1~255]: The multicast TTL (Time To Live) is the value that tells the router the range a packet can be forwarded.

Dynamic DNS

This section explains how to configure the dynamic domain name service for the camera. DDNS is a service that allows your camera, especially when assigned with a dynamic IP address, to have a fixed host and domain name.

Enable DDNS: Select this option to enable the DDNS setting.

Server Name: Select a DDNS server name from the provider drop-down list. With a Dynamic DNS account, the camera automatically updates your IP address. To enable DDNS, enter your host information. Click **Next** to continue.

Host Name: Enter the host name of the DDNS server.

User name: Enter your user name or e-mail used to connect to the DDNS

Password: Enter your password used to connect to the DDNS server.

Status: Indicate the connection status, automatically determined by the system.

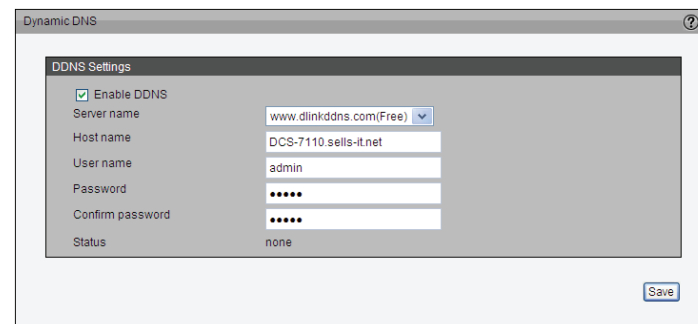

The screenshot shows a web interface window titled "Dynamic DNS". Inside, there is a "DDNS Settings" section with the following fields:

- Enable DDNS
- Server name: www.dlinkddns.com(Free) (dropdown menu)
- Host name: DCS-7110.sells-it.net (text input)
- User name: admin (text input)
- Password: ••••• (password input)
- Confirm password: ••••• (password input)
- Status: none (text input)

A "Save" button is located at the bottom right of the settings area.

HTTPS

This section explains how to enable authentication and encrypted communication over *SSL (Secure Socket Layer)*. It helps protect streaming data transmission over the Internet on a higher security level.

Enable HTTPS

Select this item to enable HTTPS communication, then select a connection option: **HTTP & HTTPS** or **HTTPS only**. Note that you have to create and install a certificate first in the second column before clicking the **Save** button.

Create and Install Certificate Method

Before using HTTPS for communication with the camera, a certificate must be created first.

There are three ways to create and install a certificate:

Create Self-signed Certificate Automatically

1. Select this option.
2. In the first column, select **Enable HTTPS secure connection**, then select a connection option: **HTTP & HTTPS** or **HTTPS only**.
3. Click **Save** to generate a certificate.
4. The *Certificate Information* will automatically be displayed in the third section. You can click **Property** to view detailed information about the certificate.
5. Click **Live Video** to return to the main page. Change the address from "**http://**" to "**https://**" in the address bar and press **Enter**. Some security alert dialogs will pop up. Click **OK** or **Yes** to enable HTTPS.

Create Self-signed Certificate Manually

1. Click **Create** to open the *Create Certificate* page, then click **Save** to generate the certificate.
2. The *Certificate Information* will automatically be displayed in the third section as shown below. You can click **Property** to see detailed information about the certificate.

The screenshot shows the 'HTTPS' configuration window. It is divided into three main sections:

- Enable HTTPS:** A checkbox for 'Enable HTTPS secure connection' is checked. Below it are two radio buttons: 'HTTP & HTTPS' (selected) and 'HTTPS only'.
- Create and install certificate method:** Three radio buttons are present: 'Create self-signed certificate automatically', 'Create self-signed certificate manually' (selected), and 'Create certificate request and install'. A 'Create' button is visible next to the 'Self-signed certificate:' label.
- Certificate Information:** A table-like view showing certificate details: Status: Active (dropdown), Country: US, State or province: California, Locality: Fountain Valley, Organization: D-Link Corporation, Organization Unit: Marketing Department, and Common Name: www.dlink.com. 'Property' and 'Remove' buttons are at the bottom.

Create Certificate Request and Install

Select this option to create a certificate from a certificate authority.

1. Click **Create** to open the *Create Certificate* page, then click **Save** to generate the certificate.
2. If you see the information bar, click **OK** and click on the **information bar** at the top of the page to allow pop-up.
3. The pop-up window shows an example of a certificate request.
4. Look for a trusted certificate authority that issues digital certificates. Enroll the camera.

Wait for the certificate authority to issue a SSL certificate. Click **Browse...** to search for the issued certificate, then click **Upload** in the second column.

How do I cancel the HTTPS setting?

1. Deselect **Enable HTTPS secure connection** in the first column and click **Save**.
A warning dialog will pop up.
2. Click **OK** to disable HTTPS.
3. The web page will redirect to a non-HTTPS page automatically.

If you want to create and install other certificates, please remove the existing one. To remove the signed certificate, deselect **Enable HTTPS secure connection** in the first column and click **Save**. Then click **Remove** to erase the certificate.

The screenshot shows a web interface titled "HTTPS" with a help icon. It is divided into three main sections:

- Enable HTTPS:** Contains a checked checkbox for "Enable HTTPS secure connection" and two radio buttons: "HTTP & HTTPS" (selected) and "HTTPS only". A "Save" button is located to the right.
- Create and install certificate method:** Contains three radio buttons: "Create self-signed certificate automatically", "Create self-signed certificate manually" (selected), and "Create certificate request and install". Below the "Create self-signed certificate manually" option is a "Self-signed certificate:" label and a "Create" button.
- Certificate Information:** A table-like form with the following fields:
 - Status: Active (dropdown menu)
 - Country: US
 - State or province: California
 - Locality: Fountain Valley
 - Organization: D-Link Corporation
 - Organization Unit: Marketing Department
 - Common Name: www.dlink.comAt the bottom of this section are "Property" and "Remove" buttons.

Access List

This section explains how to control access permissions by verifying the connecting client PC's IP address.

General Settings

Maximum number of concurrent streaming connection(s) limited to:

Simultaneous live viewing for 1~10 clients (including stream 1 ~ stream 5). The default value is **10**. If you modify the value and click **Save**, all current connections will be disconnected and automatically attempt to re-link (i.e., Explorer or Quick Time Player).

View Information: Click this button to display the connection status window showing a list of the current connections.

- **IP address:** Current connections to the camera.
- **Elapsed time:** How much time the client has been at the web page.
- **User ID:** If the administrator has set a password for the web page, the clients have to enter a user name and password to access the live video. The user name will be displayed in the *User ID* column. If the administrator allows a client to link to the web page without a user name and password, the *User ID* column will be empty.

There are some situations which allow clients access to the *live video* without a user name and password:

1. The administrator did not set up a user password. For more information about how to set up a user password and manage user accounts, please refer to *User Settings* on page 63.
2. The administrator has set up a user password, but set *RTSP Authentication* to "**disable**". For more information about *RTSP Authentication*, please refer to *RTSP Streaming* on page 40.

- **Refresh:** Click this button to refresh all current connections.
- **Add to deny list:** You can select entries from the *Connection Status* list and add them to the *Deny List* to deny access. Please note that the selected connections will only be disconnected temporarily and will automatically try to re-link again (i.e., Explore or Quick Time Player). If you want to enable the denied list, please select **Enable access list filtering** and click **Save** in the first column.

Disconnect: If you want to break off the current connections, please select them and click this button. Please note that those selected connections will only be disconnected temporarily and will automatically try to re-link again (i.e., Explore or Quick Time Player).

Enable Access List Filtering: Select this item and click **Save** if you want to enable the access list filtering function.

Filter Type

Select **Allow** or **Deny** as the filter type. If you choose **Allow Type**, only those clients whose IP addresses are on the *Access List* below can access the camera, and the others cannot access. On the contrary, if you choose **Deny Type**, those clients whose IP addresses are on the *Access List* will not be allowed to access the camera, and the others can access.

Filter

When you have selected a **Filter Type** you can add a rule to the following *Access List*. Please note that the IPv6 access list column will not be displayed unless you enable IPv6 on the *Network* page.

There are three types of rules:

Single: This rule allows the user to add an IP address to the *Allowed/Denied List*.

Network: This rule allows the user to assign a network address and corresponding subnet mask to the *Allow/Deny List*.

Range: This rule allows the user to assign a range of IP addresses to the *Allow/Deny List* (This rule is only applied to IPv4).

Administrator IP address

Always allow the IP address to access this device: You can select this item and add the administrator's IP address in this field to make sure the administrator can always connect to the device.

Advanced Settings

SNMP Configuration

This section explains how to use the SNMP on the network camera. The Simple Network Management Protocol is an application layer protocol that facilitates the exchange of management information between network devices. It helps network administrators to remotely manage network devices and solve network problems with ease.

The SNMP consists of the following three key components:

1. **Manager:** Network-Management Station (NMS), a server which executes applications that monitor and control managed devices.
2. **Agent:** A network-management software module on a managed device which transfers the status of managed devices to the NMS.
3. **Managed device:** A network node on a managed network. For example: routers, switches, bridges, hubs, computer hosts, printers, IP telephones, network cameras, web server, and databases.

Before configuring SNMP settings on this page, please enable your NMS first.

Enable SNMPv1, SNMPv2c: Select this option and enter the names of *Read/Write* community and *Read Only* community according to your NMS setting.

Enable SNMPv3: This option contains cryptographic security, a higher security level which allows you to set the authentication password and the encryption password.

- **Security name:** According to your NMS setting, choose **Read/Write** or **Read Only** and enter the community name.
- **Authentication type:** Select **MD5** or **SHA** as the authentication method.
- **Authentication password:** Enter the password for authentication (at least 8 characters).
- **Encryption password:** Enter a password for encryption (at least 8 characters).

IEEE 802.1x

Enable this function if your network environment uses IEEE 802.1x, which is a port-based network access control. The network devices, intermediary switch/access point/hub, and RADIUS server must support and enable 802.1x setting.

The screenshot displays the 'Advanced Settings' interface with the following sections:

- SNMP Configuration:**
 - Enable SNMPv1, SNMPv2c:
 - Read/Write community: Private
 - Read only community: Public
 - Enable SNMPv3:
 - Read/Write Security name: Private
 - Authentication Type: MD5
 - Authentication Password: [text input]
 - Encryption Password: [text input]
 - Read only Security name: Public
 - Authentication Type: MD5
 - Authentication Password: [text input]
 - Encryption Password: [text input]
- IEEE 802.1x:**
 - Enable IEEE 802.1x
 - EAP method: EAP-PEAP
 - Identity: [text input]
 - Password: [text input]
 - CA certificate: [text input] [Browse...] [Upload]
 - Status: no file [Remove]
- CoS:**
 - Enable CoS
 - VLAN ID: 1
 - Live Video: 0
 - Event/Alarm: 0
 - Management: 0
- QoS/DSCP:**
 - Enable QoS/DSCP
 - Live Video: 0
 - Event/Alarm: 0
 - Management: 0

Each section has a 'Save' button at the bottom right.

The 802.1x standard is designed to enhance the security of local area networks, which provides authentication to network devices (clients) attached to a network port (wired or wireless). If all certificates between client and server are verified, a point-to-point connection will be enabled. If authentication fails, access on that port will be prohibited. 802.1x utilizes an existing protocol, the Extensible Authentication Protocol (EAP), to facilitate communication.

Please follow the steps below to enable 802.1x setting:

1. Before connecting the camera to the protected network with 802.1x, please apply a digital certificate from a *Certificate Authority* (i.e., MIS of your company) which can be validated by a RADIUS server.
2. Connect the camera to a PC or notebook outside of the protected LAN. Open the configuration page of the camera as shown below. Select **EAP-PEAP** or **EAP-TLS** as the EAP method. In the following blanks, enter your ID and password issued by the *Certificate Authority*, then upload related certificate(s).
3. When all settings are complete, move the camera to the protected LAN by connecting it to an 802.1x enabled switch. The devices will then start the authentication automatically.

QoS (Quality of Service)

Quality of Service refers to a resource reservation control mechanism, which guarantees a certain quality to different services on the network. Quality of service guarantees are important if the network capacity is insufficient, especially for real-time streaming multimedia applications. Quality can be defined as, for instance, a maintained level of bit rate, low latency, no packet dropping, etc.

The following are the main benefits of a QoS-aware network:

- The ability to prioritize traffic and guarantee a certain level of performance to the data flow.
- The ability to control the amount of bandwidth each application may use, and thus provide higher reliability and stability on the network.

The screenshot displays the 'Advanced Settings' window of a camera, divided into four sections:

- SNMP Configuration:** Includes checkboxes for 'Enable SNMPv1, SNMPv2c' and 'Enable SNMPv3'. Fields for 'Read/Write community', 'Read only community', 'Read/Write Security name', 'Authentication Type' (MD5), 'Authentication Password', and 'Encryption Password' are present for both versions.
- IEEE 802.1x:** Features a checked 'Enable IEEE 802.1x' option, an 'EAP method' dropdown set to 'EAP-PEAP', and input fields for 'Identity' and 'Password'. It also includes a 'CA certificate' field with 'Browse...' and 'Upload' buttons, and a 'Remove' button.
- CoS:** Shows a checked 'Enable CoS' option and dropdown menus for 'VLAN ID' (set to 1), 'Live Video', 'Event/Alarm', and 'Management' (all set to 0).
- QoS/DSCP:** Shows a checked 'Enable QoS/DSCP' option and input fields for 'Live Video', 'Event/Alarm', and 'Management', all set to 0.

'Save' buttons are located at the bottom right of each configuration section.

Requirements for QoS:

- All network switches and routers in the network must include support for QoS.
- The network video devices used in the network must be QoS-enabled.

CoS

IEEE 802.1p defines a QoS model at OSI Layer 2 (Data Link Layer), which is called CoS, Class of Service. It adds a 3-bit value to the VLAN MAC header, which indicates prioritization from 0~7 (Eight different classes of service are available). The priority is set up on the network switches, which then use different queuing disciplines to forward the packets.

Please follow the steps below to enable CoS settings:

1. Click **Enable CoS**
2. Enter the VLAN ID of your switch (0~4095)
3. Choose the priority for each application (0~7).

Note:

- *The VLAN Switch (802.1p) is required. Web browsing may fail if the CoS setting is incorrect.*
- *Class of Service technologies do not guarantee a level of service in terms of bandwidth and delivery time. They only offer a "best-effort." Users can think of CoS as a "coarsely-grained" traffic control and QoS as a "finely-grained" traffic control.*
- *Though CoS is simple to manage, it lacks scalability and does not offer end-to-end guarantees since it is based on L2 protocol.*

QoS/DSCP

DSCP-ECN defines QoS at Layer 3 (Network Layer). The Differentiated Services (DiffServ) model is based on packet marking and router queuing disciplines. The marking is done by adding a field to the IP header, called the DSCP (Differentiated Services Code Point). This is a 6-bit field that provides 64 different class IDs. It gives an indication of how a given packet is to be forwarded, known as the Per Hop Behavior (PHB). The PHB describes a particular service level in terms of bandwidth, queuing theory, and dropping (discarding the packet) decisions. Routers at each network node classify packets according to their DSCP value and give them a particular forwarding treatment, for example, how much bandwidth should be reserved.

The screenshot displays the 'Advanced Settings' configuration page, divided into four sections:

- SNMP Configuration:** Includes checkboxes for 'Enable SNMPv1, SNMPv2c' and 'Enable SNMPv3'. Fields for 'Read/Write community', 'Read only community', 'Read/Write Security name', 'Read only Security name', 'Authentication Type' (set to MD5), and 'Authentication Password' are visible.
- IEEE 802.1x:** Features a checked 'Enable IEEE 802.1x' box, an 'EAP method' dropdown (set to EAP-PEAP), and fields for 'Identity', 'Password', and 'CA certificate' (with 'Browse...' and 'Upload' buttons). A 'Remove' button is present below the CA certificate field.
- CoS:** Shows a checked 'Enable CoS' box, a 'VLAN ID' field (set to 1), and dropdown menus for 'Live Video', 'Event/Alarm', and 'Management' (all set to 0).
- QoS/DSCP:** Shows a checked 'Enable QoS/DSCP' box and input fields for 'Live Video', 'Event/Alarm', and 'Management' (all set to 0).

'Save' buttons are located at the bottom right of each configuration section.

Event Management

Motion Detection

Motion can be detected by measuring change in speed or vector of an object or objects in the field of view.

Enable Motion Detection: Select this option to turn on the motion detection feature.

Window Name: Create your own name for the monitored area/window. It will show at the top of the motion window.

Sensitivity: Set the measurable difference between two sequential images that would indicate motion.

Percentage: Set the amount of motion in the window being monitored that is required to trigger a motion detected alert. If this is set to 100%, this means that motion must be detected within the whole window to trigger a snapshot.

Note: Setting a higher sensitivity and a lower percentage will make motion easier to be detected.

New: Click to add a new window. A maximum of three motion windows can be opened simultaneously. Use your mouse to drag the window frame to re-size or the title bar to move. Clicking on the 'X' at the upper right corner of the window will close the window.

Save: Save the configured settings.

To enable motion detection, follow the steps below:

1. Click **New** to add a new motion detection window.
2. Enter a name in the *Window Name* field.
3. Define the sensitivity to moving objects and the space ratio of all alerted pixels by moving the **Sensitivity** and **Percentage** slide bar.
4. Click **Save** to apply the changes.
5. Select **Enable motion detection** to activate motion detection.

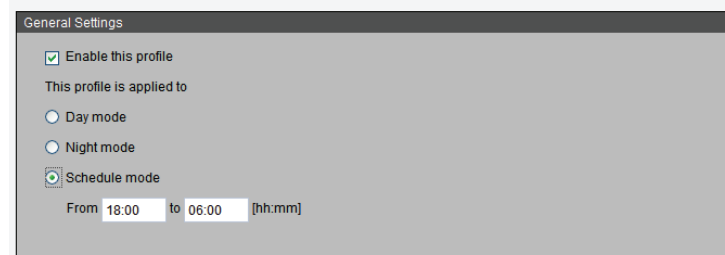
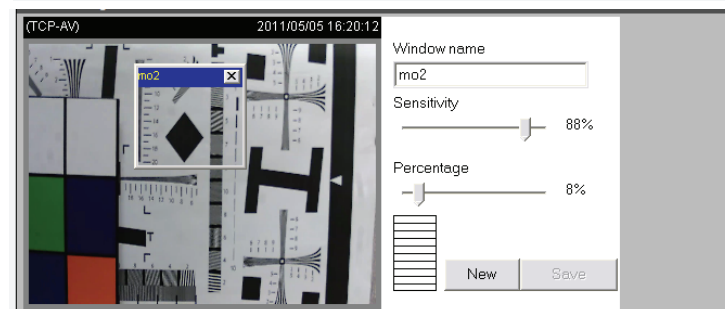

Profile:

You can configure two sets of sensor settings; **Profile 1** for normal situations, and **Profile 2** for special situations such as **Day/Night/Schedule Mode**.

Tamper Detection

With *Tamper Detection*, the camera is capable of detecting incidents such as redirection, blocking, de-focusing or even spray paint.

To enable tamper detection, follow the steps given below:

1. Select **Enable camera tampering detection**.
2. Enter the tamper trigger duration (10 sec. ~ 10 min.). The tamper alarm will be triggered only when the tampering factor (the difference between current frame and pre-saved background) exceeds the trigger threshold.

Set up the event source as *Camera Tampering Detection* on **Event Settings > Server Settings** (how to send alarm message)/ **Media Settings** (send what type of alarm message)/**Event Settings**/. Please refer to *Event Settings* on page 52 for detailed information.

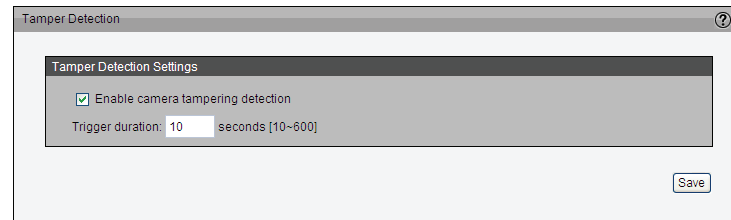

Event Settings

This section explains how to configure the camera to respond to particular situations (events). A typical application, such as when a motion is detected, causes the camera to send buffered images to an FTP server or e-mail address as notifications.

Server Settings

Click **Add Server** on *Event Settings* page to open the *Server Settings* page. You can specify where the notification messages are sent when a trigger is activated. A total of five server settings can be configured.

Server name: Enter a name for the server setting.

Server Type: There are four choices of server types available: **E-mail**, **FTP**, **HTTP**, and **Network Storage**. Select the server type to display detailed configuration options. You can configure one or all of them.

E-mail: Select to send the media files via e-mail when a trigger is activated.

- **Sender e-mail address:** Enter the e-mail address of the sender.
- **Recipient e-mail address:** Enter the e-mail address of the recipient.
- **Server address:** Enter the domain name or IP address of the e-mail server.
- **User name:** Enter the user name of the e-mail account if necessary.
- **Password:** Enter the password of the e-mail account if necessary.
- **Server port:** The default mail server port is set to **25**. You can also manually set another port.

If your SMTP server requires a secure connection (SSL), select **This server requires a secure connection (SSL)**.

To verify if the e-mail settings are correctly configured, click **Test**. The result will be shown in a pop-up window. If successful, you will also receive an e-mail indicating the result.

Click **Save** to enable the settings, then click **Close** to exit the page.

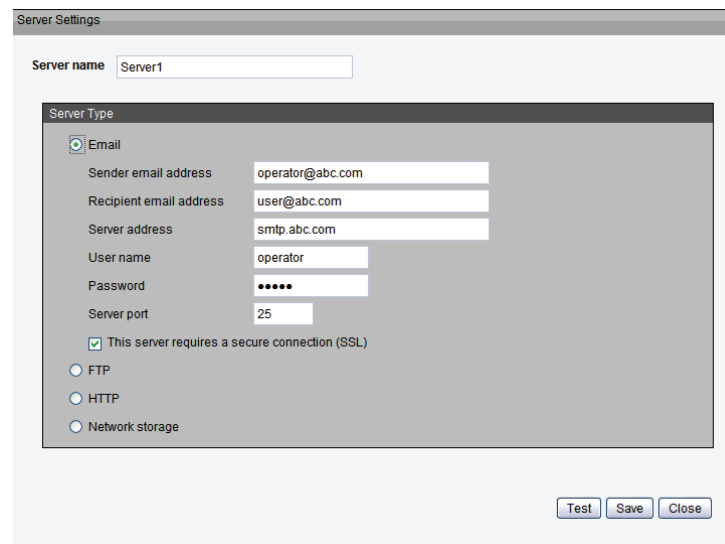
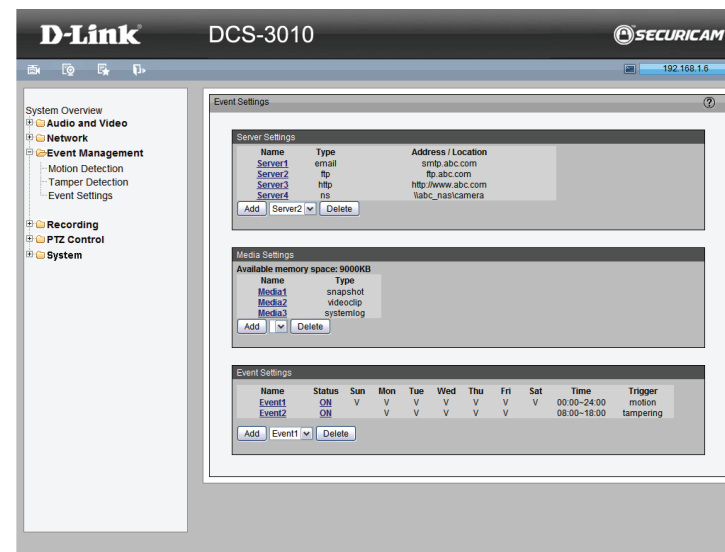

FTP: Select to send the media files to an FTP server when a trigger is activated.

- **Server address:** Enter the domain name or IP address of the FTP server.
- **Server port:** By default, the FTP server port is set to 21. It can also be assigned to another port number between 1025 and 65535.
- **User name:** Enter the login name of the FTP account.
- **Password:** Enter the password of the FTP account.
- **FTP folder name:** Enter the folder where the media file will be placed. If the folder name does not exist, the camera will create one on the FTP server.
- **Passive mode:** Most firewalls do not accept new connections initiated from external requests. If the FTP server supports passive mode, select this option to enable passive mode FTP and allow data transmission to pass through the firewall.

To verify if the FTP settings are correctly configured, click **Test**. The result will be shown in a pop-up window. If successful, you will also receive a *test.txt* file on the FTP server.

Click **Save** to enable the settings, then click **Close** to exit the page.

HTTP: Select to send the media files to an HTTP server when a trigger is activated.

- **URL:** Enter the URL of the HTTP server.
- **User name:** Enter the user name if necessary.
- **Password:** Enter the password if necessary.

To verify if the HTTP settings are correctly configured, click **Test**. The result will be shown in a pop-up window. If successful, you will receive a *test.txt* file on the HTTP server. Click **Save** to enable the settings then click **Close** to exit the page.

Network storage: Select to send the media files to a network storage location when a trigger is activated. Click **Save** to enable the setting, then click **Close** to exit the page. When completed, the new server settings will automatically be displayed on the *Event Settings* page.

The screenshot shows the configuration window for 'Server2'. The 'Server Type' section has 'FTP' selected. The fields are filled with: Server address: ftp.abc.com, Server port: 21, User name: operator, Password: [masked], and FTP folder name: [empty]. The 'Passive mode' checkbox is checked. At the bottom right are 'Test', 'Save', and 'Close' buttons.

The screenshot shows the configuration window for 'Server3'. The 'Server Type' section has 'HTTP' selected. The fields are filled with: URL: http://www.abc.com, User name: operator, and Password: [masked]. At the bottom right are 'Test', 'Save', and 'Close' buttons.

The screenshot shows the configuration window for 'Server4'. The 'Server Type' section has 'Network storage' selected. The fields are filled with: Network storage location: \\abc_nas\camera, Workgroup: ipcam, User name: operator, and Password: [masked]. A note below the location field says '(For example: \\my_nas\disk\folder)'. At the bottom right are 'Test', 'Save', and 'Close' buttons.

Media Settings

Click **Add Media** to open the *Media Settings* page. On this page, you can specify the type of media that will be sent when a trigger is activated. A total of five media settings can be configured.

Media name: Enter a name for the media setting.

Media Type: There are three choices of media types available: **Snapshot**, **Video clip**, and **System log**. Select the item to display the detailed configuration options. You can configure one or all of them.

Snapshot: Select to send snapshots when a trigger is activated.

- **Source:** Select to take snapshots from stream 1 ~ 4.
- **Send pre-event images:** The camera has a buffer area. It temporarily holds data up to a certain limit. Enter a number to decide how many images to capture before a trigger is activated. Up to 7 images can be generated.
- **Send post-event images:** Enter a number to decide how many images to capture after a trigger is activated. Up to 7 images can be generated.
- **File name prefix:** Enter the text that will be attached to the front of the file name.
- **Add date and time suffix to the file name:** Select this option to add a date/time suffix to the file name.

Click **Save** to enable the settings, then click **Close** to exit the page.

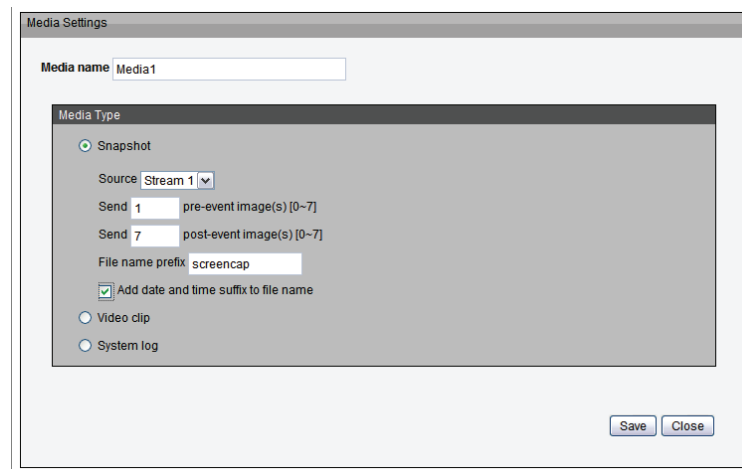

Video clip: Select to send video clips when a trigger is activated.

- **Source:** Select a source of video clip.
- **Pre-event recording:** The camera has a buffer area. It temporarily holds data up to a certain limit. Enter a number to decide the duration of recording before a trigger is activated. Nine seconds is the maximum.
- **Maximum duration:** Specify the maximum recording duration in seconds. Up to 20 seconds can be set. For example, if pre-event recording is set to five seconds and the maximum duration is set to 10 seconds, the camera continues to record for another 4 seconds after a trigger is activated.
- **Maximum file size:** Specify the maximum file size allowed.
- **File name prefix:** Enter the text that will be attached to the front of the file name.

Click **Save** to enable the settings, then click **Close** to exit the page.

System log: Select to send a system log when a trigger is activated.

Click **Save** to enable the settings, then click **Close** to exit the page.

When completed, click **Save** to enable the settings and click **Close** to exit this page. The new media settings will appear on the *Event Settings* page.

The screenshot shows the 'Media Settings' dialog box for 'Media2'. The 'Media Type' section has 'Video clip' selected. The 'Source' is set to 'Stream 3'. The 'Pre-event recording' is set to 5 seconds. The 'Maximum duration' is set to 5 seconds. The 'Maximum file size' is set to 1500 Kbytes. The 'File name prefix' is set to 'videos'. There are 'Save' and 'Close' buttons at the bottom right.

The screenshot shows the 'Media Settings' dialog box for 'Media3'. The 'Media Type' section has 'System log' selected. There are 'Save' and 'Close' buttons at the bottom right.

Event Settings

In the *Event Settings* column, click **Add** to open the *Event Settings* page. On this page, you can arrange three elements - *Trigger*, *Schedule*, and *Action* to set an event. A total of three event settings can be configured.

Event name: Enter a name for the event.

Enable this event: Select to activate this event.

Priority: Set the priority for this event (**High**, **Normal**, or **Low**). The event with higher priority will be executed first

Detect next event after [] seconds: Select the delay time before selecting the next event. It is being used for both events of motion detection and digital input trigger.

Trigger

This is the cause or stimulus which defines when to trigger the camera. The trigger source can be configured to use the camera's built-in motion detection mechanism. There are several choices of trigger sources as shown below. Select the item to display the detailed configuration options.

Video motion detection: This option makes use of the built-in motion detection mechanism as a trigger source. To enable this function, you need to configure a *Motion Detection Window* first. For more information, please refer to *Motion Detection* on page 50 for details.

Periodically: This option allows the camera to trigger periodically for every other defined minute. Up to 999 minutes are allowed.

System boot: This option triggers the camera when the power to the camera is disconnected.

Recording notify: This option allows the camera to trigger when the recording disk is full or when recording starts to rewrite older data.

Camera tampering detection: This option allows the camera to trigger when the camera detects that it is being tampered with. To enable this function, you need to configure the *Tamper Detection* option first. Please refer to *Tamper Detection* on page 51 for detailed information.

Event Schedule

Specify the period for the event:

1. Select the days of the week.
2. Select the recording schedule in 24-hour time format.

Action

Define the actions to be performed by the camera when a trigger is activated.

To set an event with recorded video or snapshots, it is necessary to configure the server and media settings so that the camera will know what action to take (i.e., which server to send the media files to) when a trigger is activated.

- **Add Server:** Same as *Server Settings*.
- **Add Media:** Same as *Media Settings*.

Recording

Recording Settings

Click **Add** to open the *Recording Setting* page. In this page, you can define the recording source, recording schedule and recording capacity. A total of two recording settings can be configured.

Recording name: Enter a name for the recording setting.

Enable this recording: Select this option to enable video recording.

Priority: Select the relative importance of this recording setting (**High**, **Normal** and **Low**).

Source: Select the recording source (stream 1 ~ 4).

Trigger: Select a trigger source.

Schedule: The server will start to record files on the network storage (NAS).

Recording Schedule: Specify the recording duration.

1. Select the days of the week.
2. Select the recording start and end times in 24-hr time format.

Destination: You can select the network storage or local microSD card that was set up for the recorded video files.

Capacity: You can choose either the entire free space available or limit the reserved space. The recording size limit must be larger than the reserved amount for cyclic recording.

File name prefix: Enter the text that will be appended to the front of the file name.

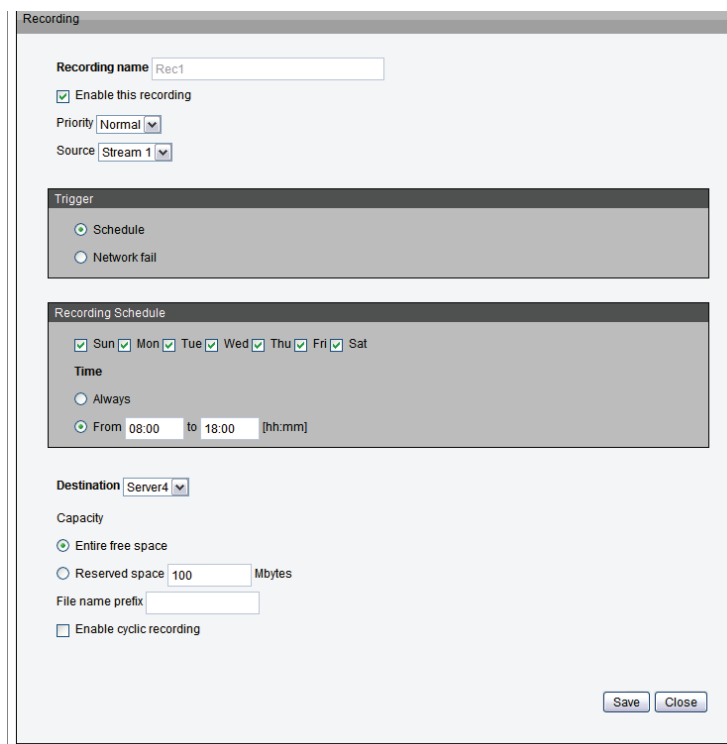
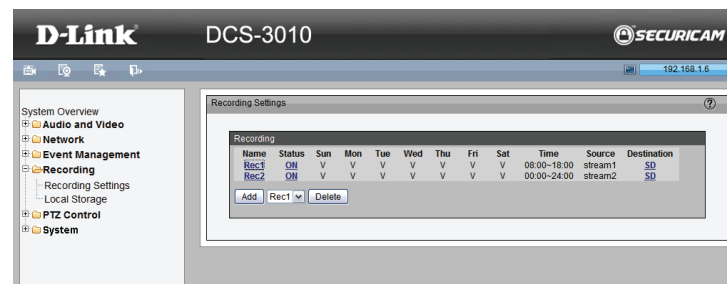

Enable cyclic recording: If you select this item, when the maximum capacity is reached, the oldest file will be overwritten by the latest one. The reserved amount is reserved for cyclic recording to prevent malfunction. This value must be larger than 15Mbytes.

If you want to enable *Recording Notification*, please click **Application** to set up. Please refer to *Trigger: Recording notify* on page 57 for detailed information.

When completed, select **Enable this recording**. Click **Save** to enable the setting and click **Close** to exit this page. When the system begins recording, it will send the recorded files to the Network Storage.

The new recording name will appear in the drop-down list on the recording page.

To remove a recording setting from the list, select a recording name from the drop-down list and click **Delete**.

Local Storage

This section explains how to manage the local storage on the Network Camera. Here you can view microSD card status, search for recorded files to playback, download, etc.

SD Card Management

SD card status: This column shows the status and reserved space of your microSD card. Please remember to format the micorSD card when using for the first time.

Enable cyclic storage: Check this item if you want to enable cyclic recording. When the maximum capacity is reached, the oldest file will be overwritten by the latest one.

Enable automatic disk cleanup: Check this item and enter the number of days you wish to retain a file. For example, if you enter "7 days," the recorded files will be stored on the microSD card for seven days. Click **Save** to enable your settings.

Searching and Viewing the Records

This section allows the user to set up search criteria for recorded data. If you do not select any criteria and click the **Search** button, all recorded data will be listed in the *Search Results* column.

File attributes: Select one or more items as your search criteria.

Trigger time: Manually enter the time range you want to search. Click **Search** and the recorded data corresponding to the search criteria will be listed in *Search Results* window.

Search Results

This area will show the search results. There are four columns: **Trigger time**, **Media type**, **Trigger type**, and **Locked**. Click **up** and **down** arrow to sort the search results in either direction.

The screenshot shows the D-Link DCS-3010 web interface. The top navigation bar includes the D-Link logo, the model number DCS-3010, and the SECURICAM logo. The left sidebar contains a menu with categories: System Overview, Audio and Video, Network, Event Management, Recording, Recording Settings, Local Storage, PTZ Control, and System. The main content area is titled 'Local Storage' and contains the following sections:

- SD Card Management:** Shows SD card status as 'Ready'. Total size is 2007176 KBytes, Free size is 1722396 KBytes, Used size is 284780 KBytes, and Use (%) is 14.19%. There is a 'Format' button. Under 'SD card control', 'Enable cyclic storage' and 'Enable automatic disk cleanup' are checked. The 'Maximum duration for keeping files' is set to 7 days. A 'Save' button is present.
- Searching and Viewing the Records:** Contains 'File attributes' with checkboxes for Trigger type (Tampering, System boot, Periodically, Digital input, Recording notify, Network fail) and Media Type (Video clip, Snapshot, Text). There are also checkboxes for 'Locked' and 'Unlocked'. The 'Trigger time' section has 'From' and 'to' date and time fields. A 'Search' button is at the bottom.
- Search Results:** Shows a table with columns: Trigger time, Media Type, Trigger type, and Locked. The table contains 12 entries, with the first one selected. Below the table are buttons for 'View', 'Download', 'Uncheck All', 'JPEGs to AVI', 'Lock / Unlock', and 'Remove'. A note states: 'Note: "View" and "Download" only apply to the highlight item'.

PTZ Control

Digital PTZ

You can set a total of 20 preset positions and select preset positions for the camera to patrol.

Please follow the steps below to preset a position:

1. Adjust the shooting area to the desired position using the buttons on the right side of the window.
2. Enter a name for the preset position, which allows for up to forty characters. Click **Add** to enable the settings. The preset positions will be displayed under the *Preset Location* list on the left-hand side.
3. To add additional preset positions, please repeat steps 1~2.
4. To remove a preset position from the list, select it from the drop-down list and click **Delete**.
5. The preset positions will also displayed on the main page.
6. Click **Save** to enable the setting. The preset positions will also be displayed on the *Live Video*. Select one from the drop-down list and the camera will move to the selected preset position.

Patrol Setting

You can select some preset positions for the camera to patrol.

Please follow the steps below to set up a patrol schedule:

1. Click a preset location on the list and click **Select**.
2. The selected preset location will be displayed on the *Source List*.
3. Set the **Dwelling time** for the preset location during auto patrol. You can also manually enter a value in the blank and click **Update**.
4. Repeat step 1 and 3 to select additional preset locations.
5. If you want to delete a selected location, select it from the *Source List* and click **Remove**.
6. Select a location and click **Up** or **Down** to rearrange the patrol order.
7. Click **Save** to enable the setting.

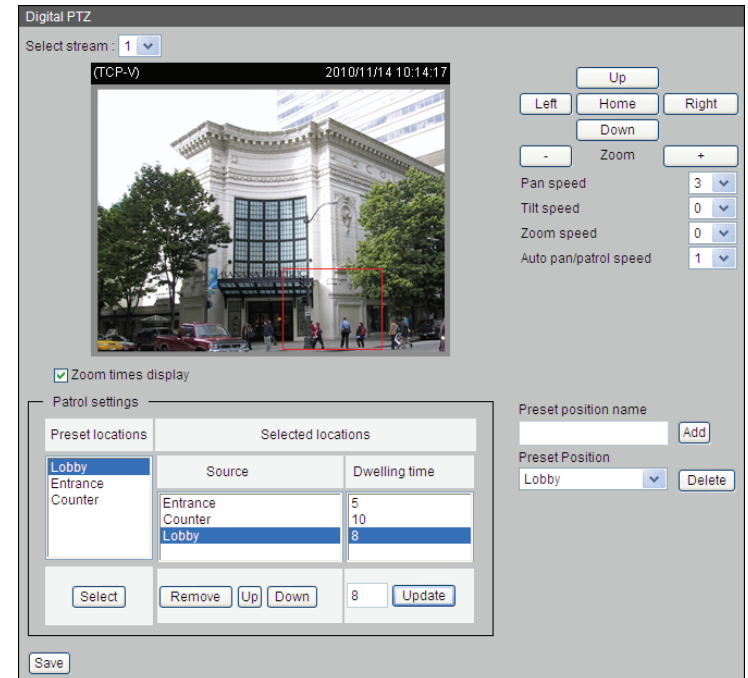

System User Settings

This section explains how to enable password protection and create multiple accounts.

Admin Password Setup:

The administrator account name is “**admin**”, which is permanent and cannot be deleted. The default of password is empty.

Add user account: Add a new user account.

User name: Enter a user name for the new account.

Password: Enter a password for the new account.

Privilege: Select the access rights for the new user.

Manage user: Manage the accounts for existing users.

Authentication: The access rights for existing users.

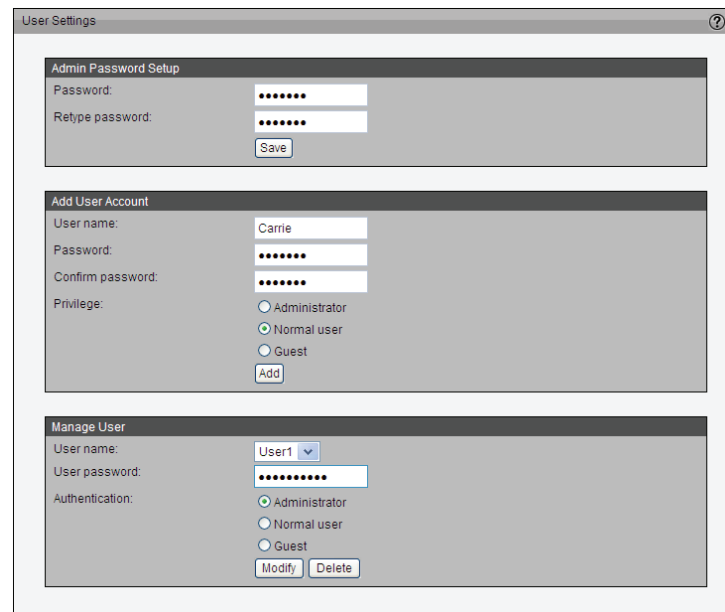

The screenshot displays the 'User Settings' web interface, which is organized into three distinct sections:

- Admin Password Setup:** This section contains two password input fields labeled 'Password:' and 'Retype password:', both filled with dots. A 'Save' button is positioned below the fields.
- Add User Account:** This section includes a 'User name:' field with the text 'Carrie', a 'Password:' field with dots, and a 'Confirm password:' field with dots. Below these is a 'Privilege:' section with three radio button options: 'Administrator', 'Normal user', and 'Guest'. An 'Add' button is located at the bottom of this section.
- Manage User:** This section features a 'User name:' dropdown menu currently set to 'User1', a 'User password:' field with dots, and an 'Authentication:' section with three radio button options: 'Administrator', 'Normal user', and 'Guest'. 'Modify' and 'Delete' buttons are located at the bottom.

Device Settings

Turn off the LED indicator: Select this option to turn off the LED next to the lens. This will prevent anyone from observing the operation of the network camera.

Camera Name: Create a unique name for your camera.

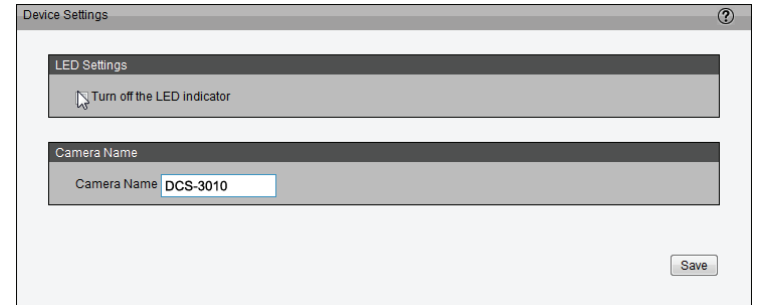

The screenshot shows a web browser window titled "Device Settings" with a help icon in the top right corner. The interface is divided into two main sections. The first section, titled "LED Settings", contains a single checkbox labeled "Turn off the LED indicator" which is currently unchecked. The second section, titled "Camera Name", contains a text input field labeled "Camera Name" with the value "DCS-3010" entered. A "Save" button is located in the bottom right corner of the settings area.

Time and Date

Automatically or manually configure, update, and maintain the internal system clock for your camera.

Current Server Time: Displays camera's current time.

Time Zone: Select your time zone from the drop-down menu.

Daylight-saving time: At some areas, the clocks are adjusted one hour forward during the warmer months in a year. Set the start and end date and time of Daylight-saving time according to your location.

Automatic Time Configuration: Enable this feature to obtain time configuration automatically from NTP server.

NTP Server: Network Time Protocol (NTP) synchronizes the network camera with an Internet time server. Choose the one that is closest to your location.

Update Interval: The time interval for updating the time information from NTP server.

Set the date and time manually: This option allows you to set the time and date manually.

Copy Your Computer's Time Setting: This will synchronize the time information from your PC.

The screenshot shows a web-based configuration window titled "Time and Date". It is divided into three main sections:

- Time Configuration:** Displays the current server time as "27 Apr 2012 5:49:29". Below this, there is a "Time zone" dropdown menu set to "GMT+08:00 Beijing, Chongqing, Hong Kong, Kuala Lumpur, Singapore, Taipei". An "Enable daylight saving" checkbox is unchecked. The "Daylight saving time" section includes fields for "DST start" (Month: Mar, Week: 1st, Day of week: Sun, Time: 12 am) and "DST end" (Month: Nov, Week: 1st, Day of week: Sun, Time: 12 am).
- Automatic Time Configuration:** Features a checked "Enable Automatic Time Configuration" checkbox. Below it is an "NTP server" dropdown menu with a "Select NTP server" button. The "Updating interval" is set to "One hour".
- Set the Date and Time Manually:** Contains dropdown menus for Year (2012), Month (04), Day (27), Hour (05), Minute (49), and Second (29). A "Copy Your Computer's Time Settings" button is located below these fields.

A "Save" button is positioned at the bottom right of the window.

Maintenance

This chapter explains how to restore the camera to factory default, upgrade firmware version, etc.

Reboot: This feature allows you to reboot the camera, which takes about one minute to complete. When completed, the live video page will be displayed in your browser. The following message will be displayed during the reboot process.

If the connection fails after rebooting, manually enter the IP address of the camera in the address field to resume the connection.

Restore to default: This feature allows you to restore the camera to factory default setting.

Export / Upload Files: This feature allows you to Export / Upload daylight-saving time rules, custom language files, and setting backup files.

Export daylight saving time configuration file: Click to set the start and end time of DST.

Follow the steps below to export:

1. In the *Export files* column, click **Export** to export the daylight-saving time configuration file from the camera.
2. A file download dialog will pop up as shown below. Click **Open** to review the XML file or click **Save** to store the file for editing.
3. Open the file with Microsoft® Notepad and locate your time zone. Set the start and end time of DST.
4. When completed, save the file.

Upload daylight saving time rule: Click **Browse...** and specify the XML file to upload.

Upload custom language file: Click **Browse...** and specify your own custom language file to upload.

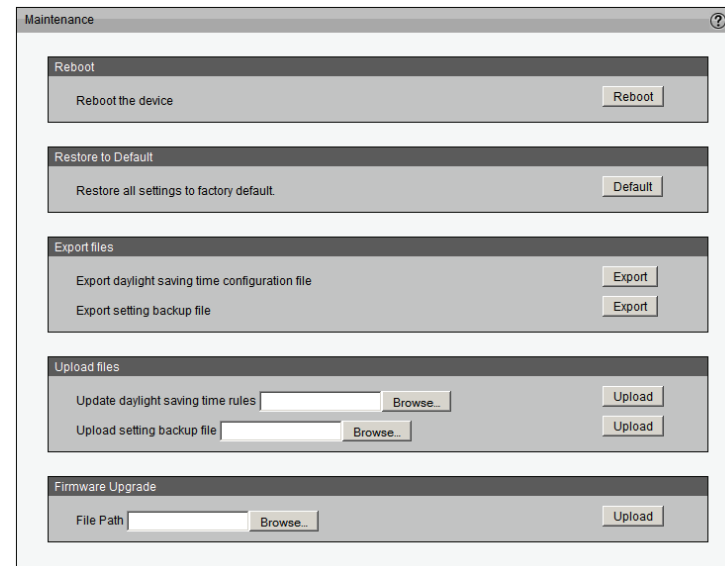

Export setting backup file: Click to export all parameters for the device and user-defined scripts.

Upload setting backup file: Click **Browse...** to upload a setting backup file. Please note that the model and firmware version of the device should be the same as the setting backup file. If you have set up a fixed IP or other special settings for your device, it is not suggested to upload a settings backup file.

Firmware upgrade: This feature allows you to upgrade the firmware of your camera. It takes a few minutes to complete the process.

Note: *Do not power off the camera during the upgrade!*

Follow the steps below to upgrade the firmware:

1. Download the latest firmware file from the D-Link website. The file is in *.pkg* file format.
2. Click **Browse...** and specify the firmware file.
3. Click **Upgrade**. The camera starts to upgrade and will reboot automatically when the upgrade completes.

If the upgrade is successful, you will see "**Reboot system now!! This connection will close.**" After that, re-access the camera.

Parameter List

The *Parameters List* page lists the entire system's parameters in alphabetical order. If you need technical assistance, please provide the information listed on this page.

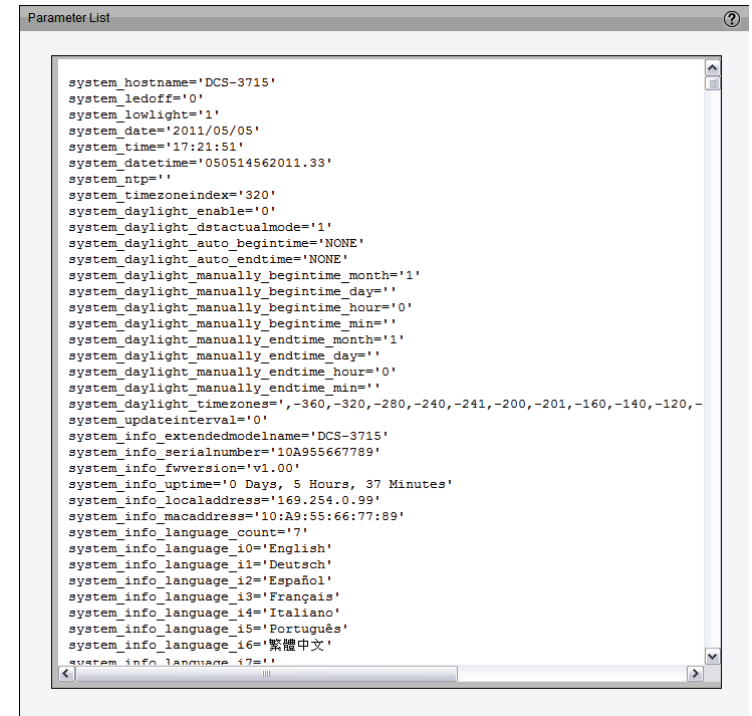

```
system_hostname='DCS-3715'  
system_ledoff='0'  
system_lowlight='1'  
system_date='2011/05/05'  
system_time='17:21:51'  
system_datetime='050514562011.33'  
system_ntp=''  
system_timezoneindex='320'  
system_daylight_enable='0'  
system_daylight_dstactualmode='1'  
system_daylight_auto_beginntime='NONE'  
system_daylight_auto_endntime='NONE'  
system_daylight_manually_beginntime_month='1'  
system_daylight_manually_beginntime_day='0'  
system_daylight_manually_beginntime_hour='0'  
system_daylight_manually_beginntime_min=''  
system_daylight_manually_endntime_month='1'  
system_daylight_manually_endntime_day='0'  
system_daylight_manually_endntime_hour='0'  
system_daylight_manually_endntime_min=''  
system_daylight_timezones=',-360,-320,-280,-240,-241,-200,-201,-160,-140,-120,-  
system_updateinterval='0'  
system_info_extendedmodelname='DCS-3715'  
system_info_serialnumber='10A955667789'  
system_info_fwversion='v1.00'  
system_info_uptime='0 Days, 5 Hours, 37 Minutes'  
system_info_localaddress='169.254.0.99'  
system_info_macaddress='10:A9:55:66:77:89'  
system_info_language_count='7'  
system_info_language_10='English'  
system_info_language_11='Deutsch'  
system_info_language_12='Español'  
system_info_language_13='Français'  
system_info_language_14='Italiano'  
system_info_language_15='Português'  
system_info_language_16='繁體中文'  
system_info_language_17=''
```

Logs

This section explains how to configure the camera to send the system log to the remote server as backup.

Remote Log: You can configure the camera to send the system log file to a remote server as a log backup. Before utilizing this feature, it is suggested that the a log-recording tool be first installed on the remote server to receive system log messages from the camera. Be sure to note the IP address of the remote server.

Follow the steps below to set up the remote log:

1. In the IP address text box, enter the IP address of the remote server.
2. In the port text box, enter the port number of the remote server.
3. When completed, select **Enable remote log** and click **Save** to enable the setting.

Current Log: This column displays the system log in chronological order. The system log is stored in the camera's buffer area and will be overwritten when reaching a certain limit.

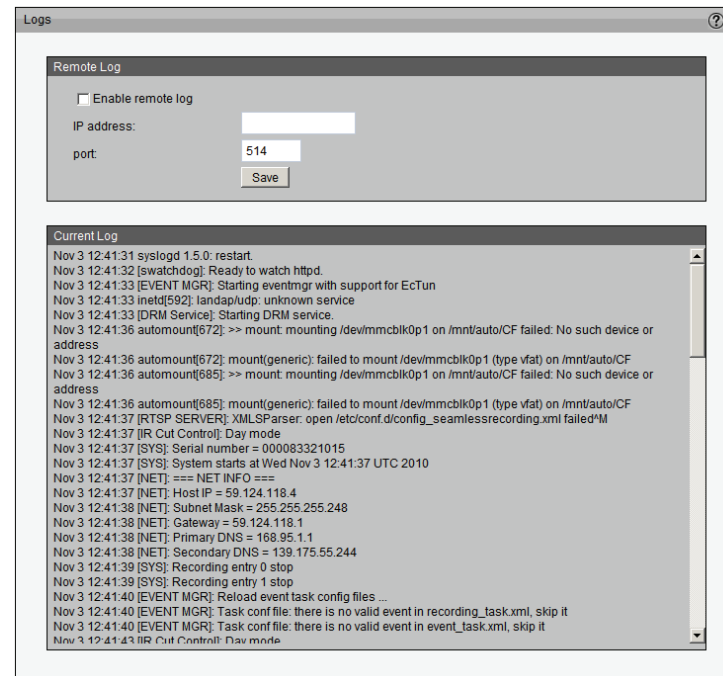

Technical Specifications

Camera	Hardware Profile	<ul style="list-style-type: none"> ▪ 1/4" 1 Megapixel CMOS sensor ▪ 256 Mbytes SDRAM ▪ 32 Mbytes of flash memory ▪ 4mm fixed lens 	<ul style="list-style-type: none"> ▪ Aperture F1.5 ▪ Angle of view <ul style="list-style-type: none"> ▪ 56.9° (H) ▪ 35.9° (V)
	Image Features	<ul style="list-style-type: none"> ▪ Configurable image size, quality, frame rate, and bit rate ▪ Time stamp and text overlays ▪ 3 configurable motion detection windows 	<ul style="list-style-type: none"> ▪ 5 configurable privacy mask zones ▪ Configurable brightness, saturation, contrast, and sharpness ▪ Min Illumination: 1 lux / F1.5
	Video Compression	<ul style="list-style-type: none"> ▪ Simultaneous H.264/MPEG-4/MJPEG format compression ▪ H.264/MPEG-4 multicast streaming 	<ul style="list-style-type: none"> ▪ JPEG for still images
	Video Resolution	<ul style="list-style-type: none"> ▪ 16:9 - 1280 x 800, 1280 x 720, 800 x 450, 640 x 360, 480 x 270, 320 x 176, 176 x 144 up to 30 fps recording¹ 	<ul style="list-style-type: none"> ▪ 4:3 - 1024 x 768, 800 x 600, 640 x 480, 480 x 360, 320 x 240, 176 x 144 up to 30 fps recording¹
	Audio Features	<ul style="list-style-type: none"> ▪ GSM-AMR speech encoding, bit rate: 4.75 kbps to 12.2 kbps ▪ G.711 audio encoding, bit rate: 8 kbps to 64 kbps ▪ MPEG-4 AAC audio encoding, bit rate: 16 kbps to 128 kbps 	
Network	Network Protocols	<ul style="list-style-type: none"> ▪ IPv4 ▪ TCP/IP ▪ UDP ▪ ICMP ▪ DHCP client ▪ NTP client (D-Link) ▪ DNS client ▪ DDNS client (D-Link) ▪ SMTP client ▪ FTP client ▪ HTTP / HTTPS 	<ul style="list-style-type: none"> ▪ Samba client ▪ PPPoE ▪ UPnP port forwarding ▪ RTP / RTSP / RTCP ▪ IP filtering ▪ QoS ▪ CoS ▪ Multicast ▪ IGMP ▪ ONVIF compliant
	Security	<ul style="list-style-type: none"> ▪ Administrator and user group protection ▪ Password authentication ▪ HTTPS streaming 	<ul style="list-style-type: none"> ▪ HTTP and RTSP digest encryption ▪ Remote client access control

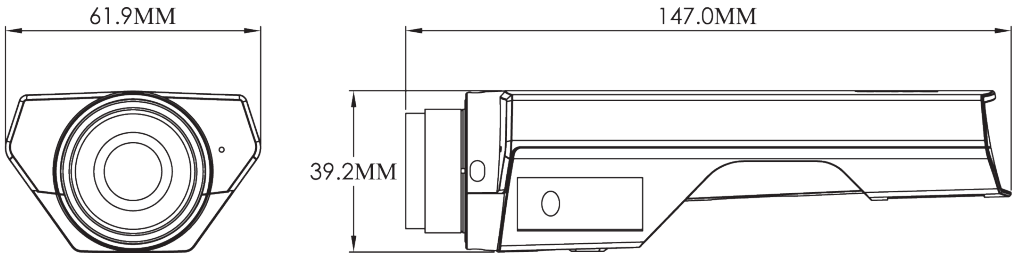
System Management	System Requirements for Web Interface	<ul style="list-style-type: none"> ▪ Browser: Internet Explorer, Firefox, Chrome
	Event Management	<ul style="list-style-type: none"> ▪ Motion detection ▪ Event notification and uploading of snapshots/video clips via e-mail or FTP ▪ Supports multiple SMTP and FTP servers ▪ Multiple event notifications ▪ Multiple recording methods for easy backup
	Remote Management	<ul style="list-style-type: none"> ▪ Take snapshots/video clips and save to local hard drive or NAS via web browser ▪ Configuration interface accessible via web browser
	Mobile Support	<ul style="list-style-type: none"> ▪ Windows 7/Vista/XP system, Pocket PC, or mobile phone
	D-ViewCam™ System Requirements	<ul style="list-style-type: none"> ▪ Operating System: Microsoft Windows 7/Vista/XP ▪ Web Browser: Internet Explorer 7 or higher ▪ Protocol: Standard TCP/IP
	D-ViewCam™ Software Functions	<ul style="list-style-type: none"> ▪ Remote management/control of up to 32 cameras ▪ Viewing of up to 32 cameras on one screen ▪ Scheduled motion triggered, or manual recording options ▪ Supports all management functions in web interface
Physical	Weight	165 g (0.34 lb)
	Power	12V DC 1.25 A, 802.3af PoE
	Power Consumption	4.6W (12V DC), 6.6W (PoE).
	Temperature	<ul style="list-style-type: none"> ▪ Operating: 0 to 40 °C (32 to 104 °F) ▪ Storage: -20 to 70 °C (-4 to 158 °F)
	Humidity	<ul style="list-style-type: none"> ▪ Operating: 20% to 80% non-condensing ▪ Storage: 5% to 95% non-condensing
	Certifications	<ul style="list-style-type: none"> ▪ CE ▪ CE LVD ▪ FCC ▪ C-Tick
Dimensions	 <p>The image contains two technical drawings of the camera. The left drawing is a front view showing a hexagonal lens housing with a diameter dimension of 61.9MM. The right drawing is a side profile view showing the camera's length as 147.0MM and its height as 39.2MM. The side view also shows the mounting bracket and the camera body.</p>	

Contacting Technical Support

U.S. and Canadian customers can contact D-Link technical support through our web site or by phone.

Before you contact technical support, please have the following ready:

- Model number of the product (e.g., DCS-3010)
- Hardware Revision (located on the label on the bottom of the Network Camera (e.g., rev A1))
- Serial Number (s/n number located on the label on the bottom of the Network Camera).

You can find software updates and user documentation on the D-Link website as well as frequently asked questions and answers to technical issues.

For customers within the United States:

Phone Support:
(877) 354-6555

Internet Support:
<http://support.dlink.com>

For customers within Canada:

Phone Support:
(877) 354-6560

Internet Support:
<http://support.dlink.ca>

Warranty

Subject to the terms and conditions set forth herein, D-Link Systems, Inc. (“D-Link”) provides this Limited Warranty:

- Only to the person or entity that originally purchased the product from D-Link or its authorized reseller or distributor, and
- Only for products purchased and delivered within the fifty states of the United States, the District of Columbia, U.S. Possessions or Protectorates, U.S. Military Installations, or addresses with an APO or FPO.

Limited Warranty:

D-Link warrants that the hardware portion of the D-Link product described below (“Hardware”) will be free from material defects in workmanship and materials under normal use from the date of original retail purchase of the product, for the period set forth below (“Warranty Period”), except as otherwise stated herein.

- Hardware (excluding power supplies and fans): Five (5) year
- Power supplies and fans: One (1) year
- Spare parts and spare kits: Ninety (90) days

The customer’s sole and exclusive remedy and the entire liability of D-Link and its suppliers under this Limited Warranty will be, at D-Link’s option, to repair or replace the defective Hardware during the Warranty Period at no charge to the original owner or to refund the actual purchase price paid. Any repair or replacement will be rendered by D-Link at an Authorized D-Link Service Office. The replacement hardware need not be new or have an identical make, model or part. D-Link may, at its option, replace the defective Hardware or any part thereof with any reconditioned product that D-Link reasonably determines is substantially equivalent (or superior) in all material respects to the defective Hardware. Repaired or replacement hardware will be warranted for the remainder of the original Warranty Period or ninety (90) days, whichever is longer, and is subject to the same limitations and exclusions. If a material defect is incapable of correction, or if D-Link determines that it is not practical to repair or replace the defective Hardware, the actual price paid by the original purchaser for the defective Hardware will be refunded by D-Link upon return to D-Link of the defective Hardware. All Hardware or part thereof that is replaced by D-Link, or for which the purchase price is refunded, shall become the property of D-Link upon replacement or refund.

Limited Software Warranty:

D-Link warrants that the software portion of the product ("Software") will substantially conform to D-Link's then current functional specifications for the Software, as set forth in the applicable documentation, from the date of original retail purchase of the Software for a period of ninety (90) days ("Software Warranty Period"), provided that the Software is properly installed on approved hardware and operated as contemplated in its documentation. D-Link further warrants that, during the Software Warranty Period, the magnetic media on which D-Link delivers the Software will be free of physical defects. The customer's sole and exclusive remedy and the entire liability of D-Link and its suppliers under this Limited Warranty will be, at D-Link's option, to replace the non-conforming Software (or defective media) with software that substantially conforms to D-Link's functional specifications for the Software or to refund the portion of the actual purchase price paid that is attributable to the Software. Except as otherwise agreed by DLink in writing, the replacement Software is provided only to the original licensee, and is subject to the terms and conditions of the license granted by D-Link for the Software. Replacement Software will be warranted for the remainder of the original Warranty Period and is subject to the same limitations and exclusions. If a material non-conformance is incapable of correction, or if D-Link determines in its sole discretion that it is not practical to replace the non-conforming Software, the price paid by the original licensee for the non-conforming Software will be refunded by D-Link; provided that the non-conforming Software (and all copies thereof) is first returned to D-Link. The license granted respecting any Software for which a refund is given automatically terminates.

Non-Applicability of Warranty:

The Limited Warranty provided hereunder for Hardware and Software portions of D-Link's products will not be applied to and does not cover any refurbished product and any product purchased through the inventory clearance or liquidation sale or other sales in which D-Link, the sellers, or the liquidators expressly disclaim their warranty obligation pertaining to the product and in that case, the product is being sold "As-Is" without any warranty whatsoever including, without limitation, the Limited Warranty as described herein, notwithstanding anything stated herein to the contrary.

Submitting A Claim (USA):

The customer shall return the product to the original purchase point based on its return policy. In case the return policy period has expired and the product is within warranty, the customer shall submit a claim to D-Link as outlined below:

- The customer must submit with the product as part of the claim a written description of the Hardware defect or Software nonconformance in sufficient detail to allow DLink to confirm the same, along with proof of purchase of the product (such as a copy of the dated purchase invoice for the product) if the product is not registered.
- The customer must obtain a Case ID Number from D-Link Technical Support at 1-877-453-5465, who will attempt to assist the customer in resolving any suspected defects with the product. If the product is considered defective, the customer must obtain a Return Material Authorization ("RMA") number by completing the RMA form and entering the assigned Case ID Number at <https://rma.dlink.com/>.

- After an RMA number is issued, the defective product must be packaged securely in the original or other suitable shipping package to ensure that it will not be damaged in transit, and the RMA number must be prominently marked on the outside of the package. Do not include any manuals or accessories in the shipping package. DLink will only replace the defective portion of the product and will not ship back any accessories.
- The customer is responsible for all in-bound shipping charges to D-Link. No Cash on Delivery (“COD”) is allowed. Products sent COD will either be rejected by D-Link or become the property of D-Link. Products shall be fully insured by the customer and shipped to D-Link Systems, Inc., 17595 Mt. Herrmann, Fountain Valley, CA 92708. D-Link will not be held responsible for any packages that are lost in transit to D-Link. The repaired or replaced packages will be shipped to the customer via UPS Ground or any common carrier selected by D-Link. Return shipping charges shall be prepaid by D-Link if you use an address in the United States, otherwise we will ship the product to you freight collect. Expedited shipping is available upon request and provided shipping charges are prepaid by the customer. D-Link may reject or return any product that is not packaged and shipped in strict compliance with the foregoing requirements, or for which an RMA number is not visible from the outside of the package. The product owner agrees to pay D-Link’s reasonable handling and return shipping charges for any product that is not packaged and shipped in accordance with the foregoing requirements, or that is determined by D-Link not to be defective or non-conforming.

Submitting A Claim (Canada):

The customer shall return the product to the original purchase point based on its return policy. In case the return policy period has expired and the product is within warranty, the customer shall submit a claim to D-Link as outlined below:

- Customers need to provide their receipt (proof of purchase) even if the product is registered. Without a receipt, no warranty service will be done. The registration is not considered a proof of purchase.
- The customer must submit with the product as part of the claim a written description of the Hardware defect or Software nonconformance in sufficient detail to allow D-Link to confirm the same, along with proof of purchase of the product (such as a copy of the dated purchase invoice for the product) if the product is not registered.
- The customer must obtain a Case ID Number from D-Link Technical Support at 1-800-361-5265, who will attempt to assist the customer in resolving any suspected defects with the product. If the product is considered defective, the customer must obtain a Return Material Authorization (“RMA”) number by completing the RMA form and entering the assigned Case ID Number at <https://rma.dlink.ca/>.
- After an RMA number is issued, the defective product must be packaged securely in the original or other suitable shipping package to ensure that it will not be damaged in transit, and the RMA number must be prominently marked on the outside of the package. Do not include any manuals or accessories in the shipping package. D-Link will only replace the defective portion of the product and will not ship back any accessories.

- The customer is responsible for all in-bound shipping charges to D-Link. No Cash on Delivery (“COD”) is allowed. Products sent COD will be rejected by D-Link. Products shall be fully insured by the customer and shipped to D-Link Networks, Inc., 2525 Meadowvale Boulevard Mississauga, Ontario, L5N 5S2 Canada. D-Link will not be held responsible for any packages that are lost in transit to D-Link. The repaired or replaced packages will be shipped to the customer via Purolator Canada or any common carrier selected by D-Link. Return shipping charges shall be prepaid by D-Link if you use an address in Canada, otherwise we will ship the product to you freight collect. Expedited shipping is available upon request and provided shipping charges are prepaid by the customer. D-Link may reject or return any product that is not packaged and shipped in strict compliance with the foregoing requirements, or for which an RMA number is not visible from the outside of the package. The product owner agrees to pay D-Link’s reasonable handling and return shipping charges for any product that is not packaged and shipped in accordance with the foregoing requirements, or that is determined by D-Link not to be defective or non-conforming.
- RMA phone number: 1-800-361-5265 Hours of Operation: Monday-Friday, 9:00AM – 9:00PM EST

What Is Not Covered:

The Limited Warranty provided herein by D-Link does not cover:

Products that, in D-Link’s judgment, have been subjected to abuse, accident, alteration, modification, tampering, negligence, misuse, faulty installation, lack of reasonable care, repair or service in any way that is not contemplated in the documentation for the product, or if the model or serial number has been altered, tampered with, defaced or removed; Initial installation, installation and removal of the product for repair, and shipping costs; Operational adjustments covered in the operating manual for the product, and normal maintenance; Damage that occurs in shipment, due to act of God, failures due to power surge, and cosmetic damage; Any hardware, software, firmware or other products or services provided by anyone other than D-Link; and Products that have been purchased from inventory clearance or liquidation sales or other sales in which D-Link, the sellers, or the liquidators expressly disclaim their warranty obligation pertaining to the product.

While necessary maintenance or repairs on your Product can be performed by any company, we recommend that you use only an Authorized D-Link Service Office. Improper or incorrectly performed maintenance or repair voids this Limited Warranty.

Disclaimer of Other Warranties:

EXCEPT FOR THE LIMITED WARRANTY SPECIFIED HEREIN, THE PRODUCT IS PROVIDED “AS-IS” WITHOUT ANY WARRANTY OF ANY KIND WHATSOEVER INCLUDING, WITHOUT LIMITATION, ANY WARRANTY OF MERCHANTABILITY, FITNESS FOR A PARTICULAR PURPOSE AND NONINFRINGEMENT.

IF ANY IMPLIED WARRANTY CANNOT BE DISCLAIMED IN ANY TERRITORY WHERE A PRODUCT IS SOLD, THE DURATION OF SUCH IMPLIED WARRANTY SHALL BE LIMITED TO THE DURATION OF THE APPLICABLE WARRANTY PERIOD SET FORTH ABOVE. EXCEPT AS EXPRESSLY COVERED UNDER THE LIMITED WARRANTY PROVIDED HEREIN, THE ENTIRE RISK AS TO THE QUALITY, SELECTION AND PERFORMANCE OF THE PRODUCT IS WITH THE PURCHASER OF THE PRODUCT.

Limitation of Liability:

TO THE MAXIMUM EXTENT PERMITTED BY LAW, D-LINK IS NOT LIABLE UNDER ANY CONTRACT, NEGLIGENCE, STRICT LIABILITY OR OTHER LEGAL OR EQUITABLE THEORY FOR ANY LOSS OF USE OF THE PRODUCT, INCONVENIENCE OR DAMAGES OF ANY CHARACTER, WHETHER DIRECT, SPECIAL, INCIDENTAL OR CONSEQUENTIAL (INCLUDING, BUT NOT LIMITED TO, DAMAGES FOR LOSS OF GOODWILL, LOSS OF REVENUE OR PROFIT, WORK STOPPAGE, COMPUTER FAILURE OR MALFUNCTION, FAILURE OF OTHER EQUIPMENT OR COMPUTER PROGRAMS TO WHICH D-LINK'S PRODUCT IS CONNECTED WITH, LOSS OF INFORMATION OR DATA CONTAINED IN, STORED ON, OR INTEGRATED WITH ANY PRODUCT RETURNED TO D-LINK FOR WARRANTY SERVICE) RESULTING FROM THE USE OF THE PRODUCT, RELATING TO WARRANTY SERVICE, OR ARISING OUT OF ANY BREACH OF THIS LIMITED WARRANTY, EVEN IF D-LINK HAS BEEN ADVISED OF THE POSSIBILITY OF SUCH DAMAGES. THE SOLE REMEDY FOR A BREACH OF THE FOREGOING LIMITED WARRANTY IS REPAIR, REPLACEMENT OR REFUND OF THE DEFECTIVE OR NONCONFORMING PRODUCT. THE MAXIMUM LIABILITY OF D-LINK UNDER THIS WARRANTY IS LIMITED TO THE PURCHASE PRICE OF THE PRODUCT COVERED BY THE WARRANTY. THE FOREGOING EXPRESS WRITTEN WARRANTIES AND REMEDIES ARE EXCLUSIVE AND ARE IN LIEU OF ANY OTHER WARRANTIES OR REMEDIES, EXPRESS, IMPLIED OR STATUTORY.

Governing Law:

This Limited Warranty shall be governed by the laws of the State of California. Some states do not allow exclusion or limitation of incidental or consequential damages, or limitations on how long an implied warranty lasts, so the foregoing limitations and exclusions may not apply. This Limited Warranty provides specific legal rights and you may also have other rights which vary from state to state.

Trademarks:

D-Link is a registered trademark of D-Link Corporation/D-Link Systems, Inc. Other trademarks or registered trademarks are the property of their respective owners.

Copyright Statement:

No part of this publication or documentation accompanying this product may be reproduced in any form or by any means or used to make any derivative such as translation, transformation, or adaptation without permission from D-Link Corporation/D-Link Systems, Inc., as stipulated by the United States Copyright Act of 1976 and any amendments thereto. Contents are subject to change without prior notice.

Copyright ©2012 by D-Link Corporation/D-Link Systems, Inc. All rights reserved.

CE Mark Warning:

This is a Class B product. In a domestic environment, this product may cause radio interference, in which case the user may be required to take adequate measures.

Federal Communication Commission Interference Statement

This equipment has been tested and found to comply with the limits for a Class B digital device, pursuant to Part 15 of the FCC Rules. These limits are designed to provide reasonable protection against harmful interference in a residential installation. This equipment generates, uses and can radiate radio frequency energy and, if not installed and used in accordance with the instructions, may cause harmful interference to radio communications. However, there is no guarantee that interference will not occur in a particular installation. If this equipment does cause harmful interference to radio or television reception, which can be determined by turning the equipment off and on, the user is encouraged to try to correct the interference by one of the following measures:

- Reorient or relocate the receiving antenna.
- Increase the separation between the equipment and receiver.
- Connect the equipment into an outlet on a circuit different from that to which the receiver is connected.
- Consult the dealer or an experienced radio/TV technician for help.

FCC Caution: Any changes or modifications not expressly approved by the party responsible for compliance could void the user's authority to operate this equipment.

This device complies with Part 15 of the FCC Rules. Operation is subject to the following two conditions: (1) This device may not cause harmful interference, and (2) this device must accept any interference received, including interference that may cause undesired operation.

IMPORTANT NOTE:

FCC Radiation Exposure Statement:

This equipment complies with FCC radiation exposure limits set forth for an uncontrolled environment. This equipment should be installed and operated with minimum distance 20cm between the radiator & your body.

This transmitter must not be co-located or operating in conjunction with any other antenna or transmitter.

The availability of some specific channels and/or operational frequency bands are country dependent and are firmware programmed at the factory to match the intended destination. The firmware setting is not accessible by the end user.

Industry Canada Statement

This device complies with RSS-210 of the Industry Canada Rules. Operation is subject to the following two conditions:

(1) This device may not cause harmful interference, and (2) this device must accept any interference received, including interference that may cause undesired operation.

IMPORTANT NOTE:

Radiation Exposure Statement:

This equipment complies with IC radiation exposure limits set forth for an uncontrolled environment. This equipment should be installed and operated with minimum distance 20cm between the radiator & your body.

This device has been designed to operate with an antenna having a maximum gain of [2] dB. Antenna having a higher gain is strictly prohibited per regulations of Industry Canada. The required antenna impedance is 50 ohms.

Under Industry Canada regulations, this radio transmitter may only operate using an antenna of a type and maximum (or lesser) gain approved for the transmitter by Industry Canada. To reduce potential radio interference to other users, the antenna type and its gain should be so chosen that the equivalent isotropically radiated power (e.i.r.p.) is not more than that necessary for successful communication.

This radio transmitter (IC: 4216A-AP1360C1 / Model: DAP-1360LC1) has been approved by Industry Canada to operate with the antenna types listed below with the maximum permissible gain and required antenna impedance for each antenna type indicated. Antenna types not included in this list, having a gain greater than the maximum gain indicated for that type, are strictly prohibited for use with this device.

Ce dispositif est conforme à la norme CNR-210 d'Industrie Canada applicable aux appareils radio exempts de licence. Son fonctionnement est sujet aux deux conditions suivantes: (1) le dispositif ne doit pas produire de brouillage préjudiciable, et (2) ce dispositif doit accepter tout brouillage reçu, y compris un brouillage susceptible de provoquer un fonctionnement indésirable.

NOTE IMPORTANTE:

Déclaration d'exposition aux radiations:

Cet équipement est conforme aux limites d'exposition aux rayonnements IC établies pour un environnement non contrôlé. Cet équipement doit être installé et utilisé avec un minimum de 20 cm de distance entre la source de rayonnement et votre corps.

Ce dispositif a été conçu pour fonctionner avec une antenne ayant un gain maximal de dB [2]. Une antenne à gain plus élevé est strictement interdite par les règlements d'Industrie Canada. L'impédance d'antenne requise est de 50 ohms.

Conformément à la réglementation d'Industrie Canada, le présent émetteur radio peut fonctionner avec une antenne d'un type et d'un gain maximal (ou inférieur) approuvé pour l'émetteur par Industrie Canada. Dans le but de réduire les risques de brouillage radioélectrique à l'intention des autres utilisateurs, il faut choisir le type d'antenne et son gain de sorte que la puissance isotrope rayonnée équivalente (p.i.r.e.) ne dépasse pas l'intensité nécessaire à l'établissement d'une communication satisfaisante.

Le présent émetteur radio (IC: 4216A-AP1360C1 / Model: DAP-1360LC1) a été approuvé par Industrie Canada pour fonctionner avec les types d'antenne énumérés ci-dessous et ayant un gain admissible maximal et l'impédance requise pour chaque type d'antenne. Les types d'antenne non inclus dans cette liste, ou dont le gain est supérieur au gain maximal indiqué, sont strictement interdits pour l'exploitation de l'émetteur.

Antenna information: dipole / 2dBi (Brand:D-Link / Manufacturer :WHA YU)

Registration

Register your product online at registration.dlink.com



Product registration is entirely voluntary and failure to complete or return this form will not diminish your warranty rights.

Version 1.1
January 11, 2013