

iRiver

iFP-700 Series

www.iRiver.com



iRiver

Hardware Instruction Manual

**Digital Audio player/
Recorder/FM Tuner
Model iFP-700 Series**



Firmware Upgradable

Thank you for your purchase.
Please read this manual carefully
before using your new player.

www.iRiver.com

THIS DEVICE COMPLIES WITH PART 15 OF THE FCC RULES.

OPERATION IS SUBJECT TO THE FOLLOWING TWO CONDITIONS:

- (1) THIS DEVICE MAY NOT CAUSE HARMFUL INTERFERENCE, AND
- (2) THIS DEVICE MUST ACCEPT ANY INTERFERENCE RECEIVED, INCLUDING INTERFERENCE THAT MAY CAUSE UNDESIRE OPERATION.

Note : This equipment has been tested and found to comply with the limits for a Class B digital device, pursuant to part 15 of the FCC Rules. These limits are designed to provide reasonable protection against harmful interference in a residential installation.

This equipment generates, uses and can radiate radio frequency energy and, if not installed and used in accordance with the instructions, may cause harmful interference to radio communications. However, there is no guarantee that interference will not occur in a particular installation. If this equipment does cause harmful interference to radio or television reception, which can be determined by turning the equipment off and on, the user is encouraged to try to correct the interference by one or more of the following measures :

- Reorient or relocate the receiving antenna.
- Increase the separation between the equipment and receiver.
- Connect the equipment into an outlet on a circuit different from that to which the receiver is connected.
- Consult the dealer or an experienced radio/TV technician for help.

NOTE: THE MANUFACTURER IS NOT RESPONSIBLE FOR ANY RADIO OR TV INTERFERENCE CAUSED BY UNAUTHORIZED MODIFICATIONS TO THIS EQUIPMENT. SUCH MODIFICATIONS COULD VOID THE USER'S AUTHORITY TO OPERATE THE EQUIPMENT.

GETTING STARTED... *1*

LOCATING THE CONTROLS *2*

PC SOFTWARE INSTALLATION *3*

BASIC OPERATION *4*

CONVENIENT FUNCTIONS *5*

ADDITIONAL INFORMATION *6*

NOTE THIS MANUAL COVERS THE INSTALLATION AND USE OF THE PLAYER HARDWARE. FOR DETAILS REGARDING THE SOFTWARE OPERATION INCLUDING TRANSFERRING MUSIC TO THE PLAYER, PLEASE SEE THE SOFTWARE INSTRUCTION MANUAL.

- URL : www.iRiver.com
- Find information on our company, products, and customer and technical support.
- Update your player with firmware downloads. Firmware upgrades offer support for new CODECS and deliver new product features.
- Consult the product FAQ.
- Register your iRiver product online so that our Customer Service is able to provide support as efficiently as possible.
- All contents contained in this manual subject to change without notice to improve ability of this player or according to changing of specification.

iRiver Limited does not assume any responsibility for errors or omissions in this document or make any commitment to update the information contained herein.

iRiver is a registered trademark of iRiver Limited in the Republic of Korea and /or other countries and is used under license. Microsoft Windows Media and the Windows Logo are trademarks or registered trademarks of Microsoft Corporation in the United States and /or other countries.

All other brand and product names are trademarks of their respective companies or organization. All other product names may be trademarks of the companies with which they are associated.

© 1999-2004 iRiver Limited. All rights reserved.

- **Multi-Codec Player**
Supports MP3, WMA, OGG and ASF formats.
- **Firmware Upgrade**
Provides the latest updated features via firmware upgrade.
- **Graphic LCD supporting Multiple Languages**
iFP-700 Series comes with graphic LCD which can support multiple languages (40 languages).
- **FM Function**
You can easily listen to FM stations and set your favorite stations by using Auto Preset and Frequency Memory functions.
- **6 Preset EQ** : Normal, Rock, Jazz, Classic, U Bass, Metal
- **Xtreme EQ and Xtreme 3D**
Customize your own EQ with Xtreme EQ and enhance bass and surround sound with Xtreme 3D.
- **GUI (Graphic User Interface) Menu System**
- **Simple Navigation**
Simple navigation makes it easy to find any song.
- **Supports 8 levels of subfolders, 500 folders total and up to 1500 files at one time.**
- **Create your own playlists.**
- **Direct MP3 Encoding**
11.025KHz ~44.1KHz, 8Kbps ~ 320Kbps
- **Record FM Radio, Voice, or line-in from another device**
Voice record level is automatically controlled by AGC function.
- **Convenient neck strap.**
- **Supports USB 2.0** (iFP-780 Supports USB 1.1 only)

ABOUT POWER SUPPLY

Inserting a battery

1 Open the battery cover.



2 Insert the battery. (AA 1.5V type x 1ea)

Be sure to match the + and - ends of the battery with the diagram inside the battery compartment.

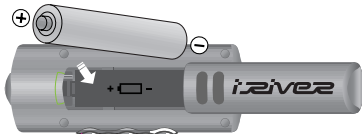

3 Close the battery cover.



※ If the battery is worn out, "Low Battery" is displayed on the LCD. Insert a fresh battery.



Low Battery

NOTE

- To avoid corrosion, remove the battery if the player is not to be used for a long time.
- Remove dead battery immediately to avoid damage from corrosion.
- When corrosion occurs, wipe the battery compartment immediately with a dry cloth and insert a new battery.

Locating the Controls

Contents

Front View _____ 2-1

Side View _____ 2-2

LCD Screen _____ 2-3

NOTE

THIS MANUAL COVERS THE INSTALLATION AND USE OF THE PLAYER HARDWARE. FOR DETAILS REGARDING THE SOFTWARE OPERATION INCLUDING TRANSFERRING MUSIC TO THE PLAYER, PLEASE SEE THE SOFTWARE INSTRUCTION MANUAL.

Locating the Controls

Front View

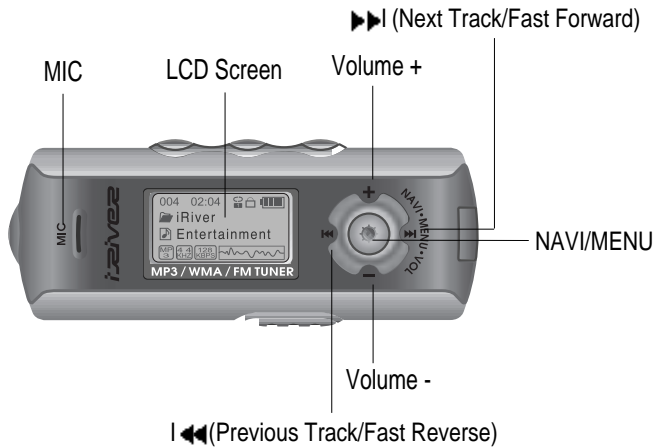

Locating the Controls

Side View

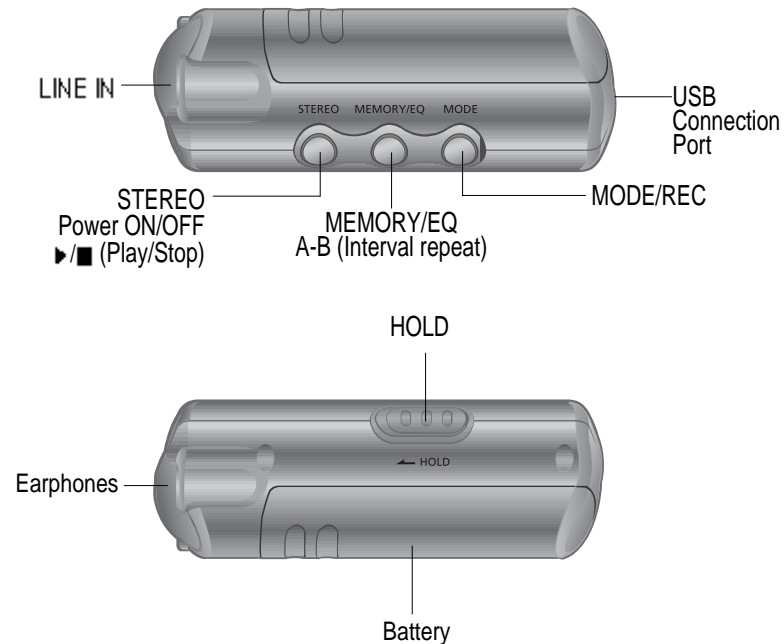

Locating the Controls

LCD Screen

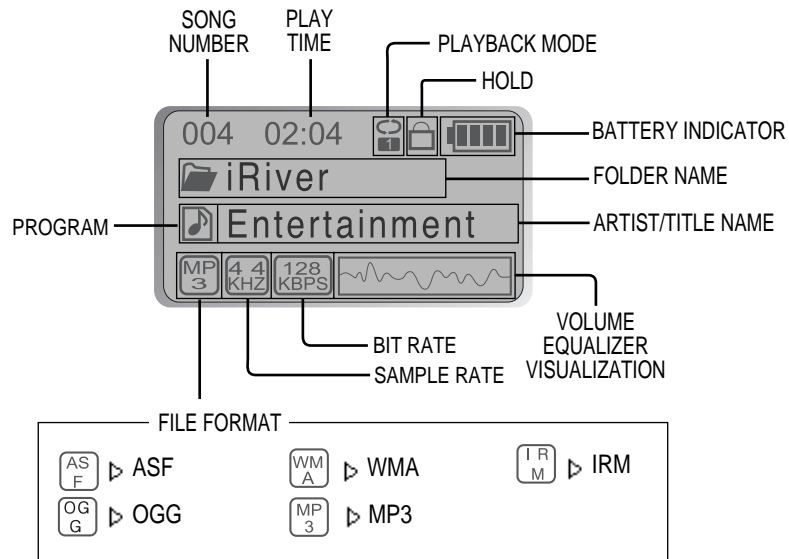

※ IRM (iRiver Rights Management)

iRiver Rights Management is a digital music format.
Please visit our web site for details about this music format.

PC software installation

Contents

PC software installation	3-1
Attach the player	3-4
Detach the player	3-7

NOTE THIS SECTION COVERS THE INSTALLATION FOR WINDOWS OPERATING SYSTEMS ONLY. FOR INSTALLATION INSTRUCTIONS FOR MAC OS, PLEASE SEE THE SOFTWARE INSTRUCTION MANUAL.

NOTE THIS MANUAL COVERS THE INSTALLATION AND USE OF THE PLAYER HARDWARE. FOR DETAILS REGARDING THE SOFTWARE OPERATION INCLUDING TRANSFERRING MUSIC TO THE PLAYER, PLEASE SEE THE SOFTWARE INSTRUCTION MANUAL.

PC software installation

Software installation

IMPORTANT Please complete the steps in this section **BEFORE ATTACHING YOUR PLAYER TO YOUR PC.**

- Insert the Installation CD into the CD-ROM drive.
The following screen appears after inserting the CD.



- If the installation doesn't automatically begin, execute the "setup.exe" file in the installation CD.
The installation program will begin.
- The installation CD contains the following contents :
 - Device Driver
 - iRiver Music Manager
 - MoodLogic
 - Manager Program for Mac

- The player can store MP3 files or files of any type.
You can upload files, other than music (MP3, WMA, OGG, ASF), to the PC using the iRiver Music Manager Program.
- Download latest versions of drivers and iRiver Music Manager at www.iRiver.com
- Please be sure your login has Administrator privileges if using Windows 2000 or Windows XP.

Note *System Requirements (Windows)*

- Pentium 133MHz or faster
- USB port
- Window 98SE / ME / 2000 / XP
- CD-ROM drive
- 10MB free hard disk space

PC software installation

Software installation

Note During this installation, the software will check online for the most recent updates. Please note that the installation screens may differ slightly from those appearing here, as software may be of a more recent version. If your screens differ, please visit www.iRiver.com/software for an updated user guide.

- 1 Insert the Installation CD into the CD-ROM drive. Installation starts automatically.
- 2 Click "Next" after selecting the language to install.



- 3 Click "Next" to Install iRiver Music Manager.



- 4 Select the folder to install.
Click "Next".

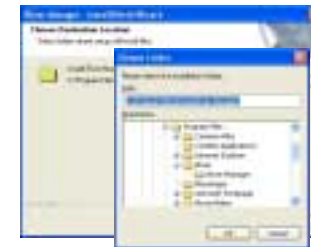

PC software installation

Software installation

- 5 Click "Next" after confirming the installation folder.



- 6 Click "Install" to begin the installation.



- 7 Installation is in progressing. Click "Finish" after the installation is completed.



Attach the player

Connecting to the PC

- 1 Connect the USB cable (provided) to the USB port of your computer.

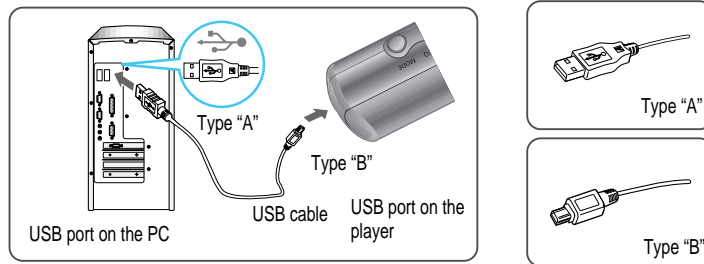

- 2 Turn on the player by pressing the button marked STEREO. Lift the protective cover over the USB port and connect the USB cable to the player.
- 3 "USB CONNECTED" will appear on the LCD screen of the player.

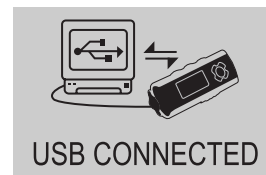
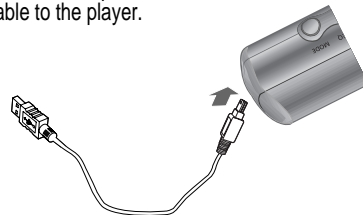

- Note**
- Connect the USB cable to the PC after playback stops to avoid errors.
 - iFP-780 supports USB 1.1 and iFP-790/ 795/ 799 supports USB 2.0 version.

Attach the player

Installation of "New Hardware"

- 1 After installing iRiver Music Manager from the CD and connecting the player to your PC, "Found New Hardware" screen is displayed.



- 3 Select "Install the software automatically (Recommended)" and click "Next".



- 2 The computer will automatically search to find your new hardware.



- 4 If a "Hardware Installation" warning message appears, click "Continue Anyway". (Windows XP)
The iRiver software driver will not cause any damage to your computer.



Attach the player

Installation of "New Hardware"

- 5 The installation will continue.



- 7 Information screen is displayed on the PC. New hardware is installed successfully and ready to use.

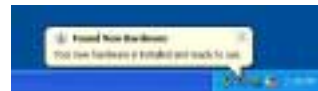

- 6 Click "Finish"
Completed the installation of "New hardware".



Detach the player

Safely Removing the player from the PC

- 1 Select the "Safely Remove hardware" after clicking the "Safe To Remove Hardware" by using the right button of mouse.



- 2 Click the "Stop" after selecting the device to remove.



- 3 Click the "OK" after confirming the hardware to remove.

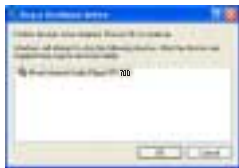

- 4 Click the "Close" after confirming the Safely Remove Hardware message. (In case of Windows XP)

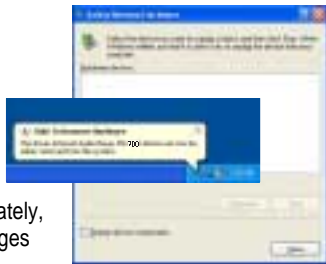

※ If the player is disconnected inaccurately, it may cause a malfunction or damages to the player.

Basic Operation

Contents

Listening to Music 4-1

Basic Operation 4-3

Operating the FM Tuner 4-7

Recording 4-11

Listening to Music

LISTENING TO MUSIC

- Connect the earphones as shown below.



- Press the PLAY/STOP button to turn on the player. Press it again to play.



- To adjust the volume

+ : To increase volume
- : To decrease volume

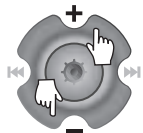

- Put the HOLD switch to "OFF".

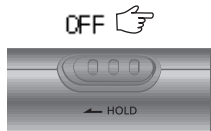

- To select song

⏮ To select previous song

⏭ To select next song

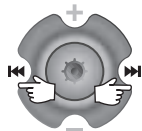

NOTE

- When "Hold" is ON, the buttons on the player will not function.
- When stopped or in recording standby mode, the player automatically turns off according to the setting of "STOP POWER OFF" on the MENU.(Refer to page 4-17)

Listening to Music



- To turn on the player



- To play



- To change modes (MP3 ← FM
← Voice recording ← LINE IN)



- To stop



- To advance



- To reverse

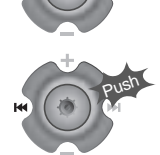

- To play the next folder

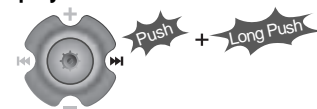

- To play the previous folder

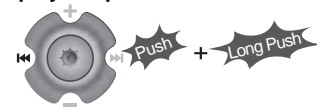

- To fast forward

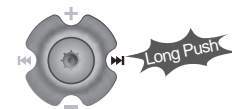

- To fast reverse

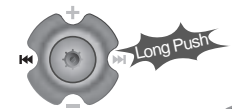

- To turn off the player



Basic Operation

Basic Operation

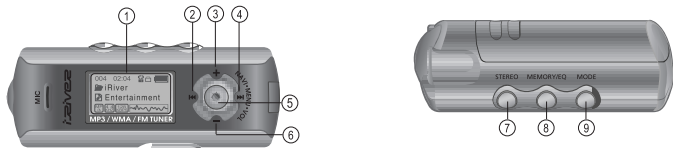

1. LCD window : Displays the operating status of the player.
2. To skip to previous track or previous FM station.
3. To increase volume.
4. To skip forward to the next song or FM station.
5. To select NAVI/MENU function.
6. To decrease volume.
7. To Play or Stop playback, to select FM mode, or to turn on/ off.
8. To select EQ mode, A-B repeat, or automatically store FM stations.
EQ : NORMAL → ROCK → JAZZ → CLASSIC → U BASS → METAL → Xtrm EQ → Xtrm 3D
9. To select function, playback mode, or record/stop recording.

Navigation



Menu

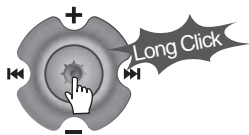

Basic Operation

Changing Functions

Press and hold the MODE button to display the current function. Push the NAVI/MENU button toward ◀◀ or ▶▶ to select the desired function, then click the NAVI/MENU button to enter that mode.

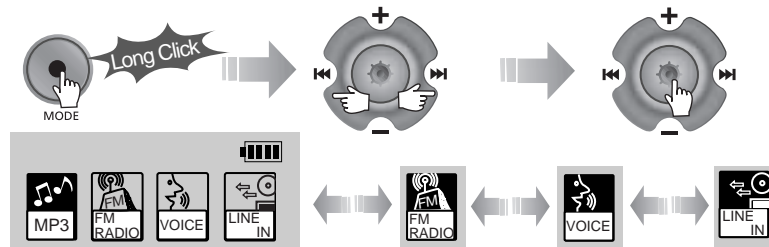

▶ MP3 Playback ◀ FM Receiving ◀ Voice Recording ◀ LINE IN Recording

Selecting FM Tuner Mode

Press the STEREO button to select STEREO or MONO.



(Refer to page 4-8)

adjusting the volume

Press + on volume button to increase volume and press - on Volume button to decrease volume.

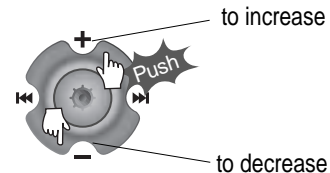

Basic Operation

NAVIGATION

Press **NAVI/MENU** button and find the desired track by pushing the VOL + or VOL - button. To select the track, press the **NAVI/MENU** button,  or the  button.

To move to the upper folder, push the  switch. If there is no upper folder, NAVIGATION stops.



MODE

During MP3 playback, you can select the playback mode by turns by clicking the MODE/REC button.





Repeat Playback					
Shuffle Playback	SFL	SFL	SFL	SFL	SFL
Intro Playback					

Press and hold the MODE/REC button : You can select MP3 or FM, Voice or Line-in recording functions. (Play mode is automatically activated when MP3 is selected).

MENU

A long press of the **NAVI/MENU** button will enter the menu system.

- 1 Scroll between menus : Push  or  (VOL + or VOL -).
- 2 Exit : Click the PLAY/STOP button (or long pressing of **NAVI/MENU** button).
- 3 Select Function: Press the **NAVI/MENU** button.

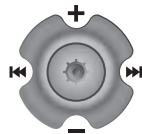

Basic Operation



DELETING FILES ON THE PLAYER

- 1 Stop playback.

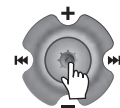

- 2 Press the "NAVI/MENU" button.



- 4 Click the "MODE" button. "FILE DELETE ARE YOU SURE?" is displayed on the screen. Select "YES" by using  or  (VOL + or VOL -) to delete. Then click NAVI/MENU button.

- 3 Select the file to delete by using VOL + or VOL -.

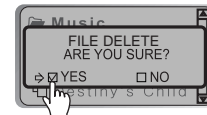



DELETING FOLDERS ON THE PLAYER

- 1 Stop playback.

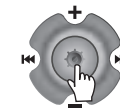

- 2 Press the "NAVI/MENU" button.



- 4 Click the "MODE" button. "FOLDER DELETE ARE YOU SURE?" is displayed on the screen. Select "YES" by using  and  (VOL + or VOL -) to delete. Then press NAVI/MENU button.

- 3 Select the folder to delete.

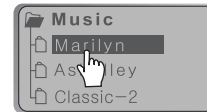

NOTE You can only delete an empty folder.

Operating the FM Tuner

OPERATING THE FM TUNER

- 1 To switch to the FM Tuner, press and hold the **MODE/REC** button.
The current function is displayed.



The function selection graphic displays on the LCD. ▶



- 2 Push the **FM RADIO** switch to select FM RADIO. Press the **NAVI/MENU** button to confirm.

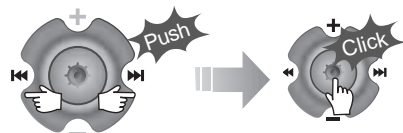

- 3 Push the **NAVI/MENU** switch toward **FM RADIO** to select your desired station.

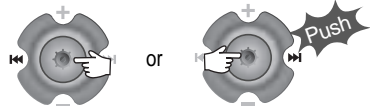

(Ex : 87.5 → 87.6)

Operating the FM Tuner

To select STEREO/MONO

- ▶ Press the **STEREO/PLAY/STOP** button to select Stereo/Mono.



Auto Scan function

To automatically locate a station press and hold **NAVI/MENU** button to the right or left.
The player will quickly scan through each frequency and stop at the next station that can be tuned in.

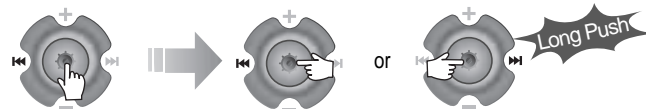

PRESET Mode

To select a station saved in memory, press the **NAVI/MENU** button to enter PRESET mode then find a saved station by pushing the **FM RADIO** switch to the left or the right.

(Ex : 89.1 → 91.9 → 93.1)

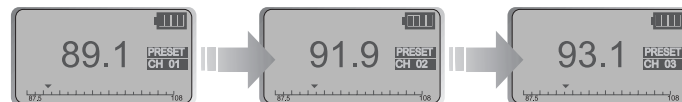

Operating the FM Tuner

Memory Function (Save stations)

1 Select a station by pushing the or switch to the left or the right.

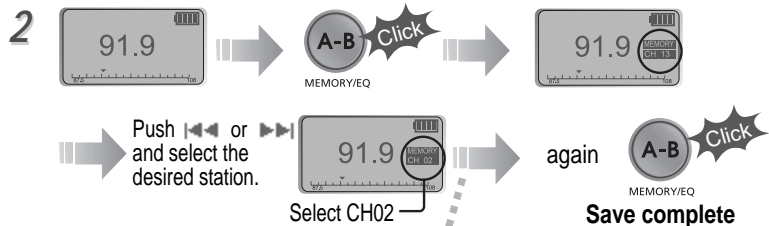

3 Up to 20 stations can be saved.



Auto memory function

Press and hold the A/B MEMORY button to automatically select stations and save them in sequential order.

(Only activates while the player is not in PRESET mode)

▲ Auto memory may not work within weak transmission areas.



Operating the FM Tuner

Memory delete function (Delete saved stations)

1 Select the station to be deleted at PRESET mode

2 Press and hold the MEMORY button.



- The next station will appear when station delete is completed.
Push the MEMORY button if you also want to delete the next station.

NOTE

- ▶ FM Tuner reception may vary in different areas.
- ▶ While in PRESET mode, auto scan and auto memory functions are not available.
- ▶ When the player doesn't have any preset stations, EMPTY will be displayed at PRESET mode then faded out.

To turn the player off

Press and hold the PLAY/STOP button to turn the player off.



Recording-FM Tuner

To record FM

Press the MODE/REC button during FM reception. The station will be recorded, the remaining recording time will be displayed on the LCD screen.



To pause FM recording

Press PLAY/STOP button to pause the recording process. Press PLAY/STOP button again to restart recording.



To stop FM recording

Press the MODE/REC button again to stop recording. The recorded file is saved as TUNER000.REC. It is saved in the RECORD folder.

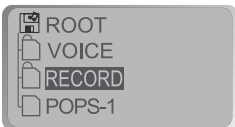

To play a recorded file

After selecting MP3 mode, select the recorded file to listen and press the PLAY/STOP button to play.

- NOTE**
- Volume can not be controlled while recording.
 - Recorded REC files can be converted to MP3 files using iRiver Manager. (Refer to page iRiver Music Manager Software Instruction Manual 32~34/37~39)

Recording-Voice

Recording Voice

1 Press and hold the MODE/REC button.



2 Press the <<< or >>> (VOL + or VOL -) switch to select Voice mode.

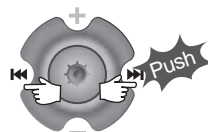

3 Press the NAVI/MENU button (or PLAY/STOP) to go to Voice recording mode. (The recorder will be in standby mode.)



4 Press the MODE/REC button again to begin recording.



Recording-Voice

To stop recording

Press the MODE/REC button.



NOTE

- After stopping a recording, starting again will create a new voice file.

NOTE

- The recorded file is saved as VOICE000.REC in the VOICE folder.
- If "00:00:00" is displayed on the LCD, the player's memory is full. To record, delete files and/or folders on the player to make some space available. (To delete : Refer to page 4-6, iRiver Music Manager)
- The player can not record when the memory is full or the battery is low.
- Keep the player far away enough from the source to avoid distortion in the recording.
- Recorded REC files can be converted to MP3 files using iRiver Manager. (Refer to page iRiver Music Manager Software Instruction Manual 4-32~4-34)

To play a recorded file

Press the PLAY/STOP button.



To pause voice recording

Press >|■ button during recording.
Press >|■ button again to restart recording.

NOTE

- Pausing the recording will not create a new file, recording will be added to the current recording.

Recording-External audio source

Recording from an external audio source

- 1 Connect the LINE OUT jack of the external equipment to the LINE IN jack of the player.



- 2 Set "LINE IN RECORDING MODE" in the MENU. (Refer to page 5-22 for details)



NOTE

- Select Line-In mode on the menu to use the external microphone.

- 3 Press and hold the MODE/REC button.



Recording-external audio source

Recording from an external audio source

- 4 Press the (VOL + or VOL -) switch to select the LINE-IN mode.

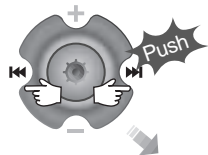

- 6 Press the MODE/REC button and LINE-IN recording is started.



- 5 Press the NAVI/MENU button (or PLAY/STOP) to go to LINE-IN recording mode. (Record Standby Mode)

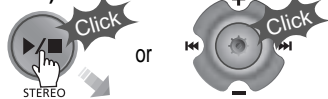

- 7 Press play on your external equipment (if necessary) to begin playback to be recorded.

NOTE

- The recorded file is saved as AUDIO000.REC, AUDIO001.REC... in sequential order. Files are saved in the RECORD folder.
- Select Ext. Mic on the CONTROL line-in/ext. mic menu to use the external microphone. (Refer to page 4-23)
- Files recorded using an external microphone are saved as EXMIC000.REC.

Recording-external audio source

To stop recording

- 1 Press the MODE/REC button.



To play a recorded file [1]

- 1 Press the PLAY/STOP button.

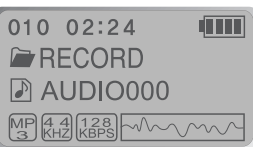

To play a recorded file [2]

- 1 After pressing the NAVI/MENU button, select a recorded file using the VOL + or VOL - switch.



- 2 Press the PLAY/STOP button.

