

DRTECH

EVS 2430Wi / EVS 2430GWi

***Safety and Regulatory Information
with User's Manual***

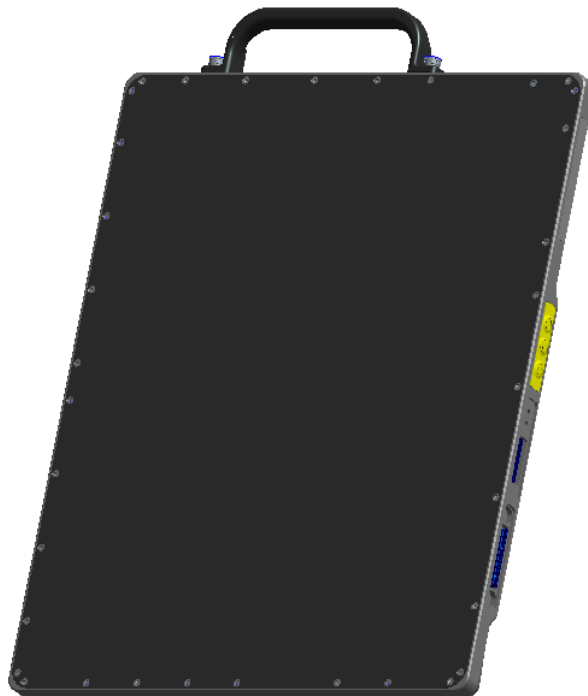

DRTECH
(주)디알텍

To Customers

Thank you for purchasing the DRTECH Radiography EVS 2430Wi (hereinafter, this Product). This User's Manual explains how to use the detector, x-ray interface unit, and other peripheral equipments. Before using this product, be sure to read this manual thoroughly in order to utilize it more effectively. Also, please read the Operation Manual for EVS Calibration and configuration Software (hereinafter, ECali1).

Important information on usage and maintenance of equipment

1. Only a physician or legally certified operator should use this product.
2. The equipment should be maintained in a safe and operable condition by maintenance personal.
3. Use only computers and image display monitors complying with IEC 60601-1 or IEC 60950-1 and under a system configuration complying with IEC 60601-1-1. For details, consult your sales representative or local DRTECH dealer.
4. Use only the dedicated cables. Do not use any cables other than those supplied with this product.

Disclaimer

1. In no event shall DRTECH be liable for any damage or loss arising from fire, earthquake, any action or accident by a third party, any intentional negligent action by users, any trial usage, or other usage under abnormal conditions.
2. Roentgenography, image processing, image reading, and image data storage must be performed in accordance with the laws of the country or region in which the product is being used. The user is responsible for maintaining the privacy of image data.
3. In no event shall DRTECH be liable for personal physical harm or property damage that is sustained when the instructions are not followed or the product is misused.
4. It is the responsibility of the attending physicians to provide medical care services. DRTECH will not be liable for faulty diagnoses.
5. In no event shall DRTECH be liable for direct or indirect consequential damages arising from the use or unavailability of this product. DRTECH shall not be liable for loss of image data for any reason.
6. In no event shall DRTECH be liable for any damage arising from moving, alteration, inspection or repair by a person other than authorized service engineers.
7. Specifications, compositions, and appearance of this product may change without prior notice.

Contents

To Customers	2
Contents	3
Safety notices	7
1. Safety Information	8
1.1. Safety precautions	8
1.2. Notes for using the equipment	13
2. Introduction.....	16
2.1. Features	16
2.2. System Configuration.....	17
2.2.1. Basic Configuration	17
3. Product Description	21
3.1. Product Components	21
3.1.1. Auto Trigger Mode (AT Mode)	21
3.1.2. Synchronization Trigger Mode (Sync. Mode).....	22
3.1.3. USB SW Mode	23
3.1.4. Workstation (Recommended and minimum but NOT included)	24
3.1.5. Grid (Recommended but Not included)	24
3.2. X-ray Imaging Condition	25
4. Components and Specifications.....	26
4.1. Detector	26
4.1.1. Detector Specification	26
4.1.2. Detector Component	27
4.2. Battery Charger and Battery Pack and Adaptor.....	28
4.2.1. Battery Charger	28
4.2.1.1. Battery Charger Specifications.....	28
4.2.1.2. Battery Charger Components.....	28

4.2.2. Battery Pack.....	29
4.2.2.1. Battery Pack Specification	29
4.2.2.2. Battery Pack Components.....	29
4.2.2.3. Charging Battery Pack.....	30
4.2.3. Adaptor	30
4.3. Wireless Charging System	31
4.3.1. EVS-WPCS	31
4.3.1.1. EVS-WPCS Specifications	31
4.3.1.2. EVS-WPCS Components	31
4.3.1.3. TX / RX Module Specification.....	32
4.3.1.4. RX Module Components	32
4.3.1.5. EVS-WPCS Operations	33
4.3.1.6. Attach Direction.....	33
4.3.1.7. Indicator LED Connector Description	34
4.3.1.8. Indicator LED Connector Description (Isolation).....	34
5. Operating Procedure	35
5.1. Preparing to Use the Detector.....	36
5.1.1. Standard Configuration.....	36
5.1.2. Battery Pack.....	37
5.1.2.1. How to Attach a Battery Pack	37
5.1.2.2. How to Detach a Battery Pack.....	37
5.1.2.3. How to Charge Battery Packs.....	38
5.2. Hardware Installation.....	40
5.2.1. Connecting Device	40
5.2.1.1. Operating AP	40
5.2.1.2. Functional Cable	42
5.2.2. Operating Detector	44
5.2.3. Image Data Retransmission.....	49
5.3. Ending Use of the Detector	50
5.4. Detector Initialization.....	50
6. Extension Facility	51
6.1. X-ray Generator Interface.....	51
6.1.1. X-ray Exposure Mode	51
6.1.2. Auto Trigger(AT) Mode	52
6.1.2.1. Recommendation of setting AT Sensing Area.....	53

6.1.3. USB SW Mode	54
6.1.3.1. Wiring USB SW Mode	55
6.1.3.2. Connector Description	55
6.1.3.3. Connector Pin Assignment	56
6.1.3.4. X-ray_UNIT	56
6.1.3.5. Hand Switch	56
6.1.3.6. PC USB	56
6.2. Software Installation	57
6.2.1. Software Classification	57
6.2.2. Software Installation	57
6.3. Windows Environment Setting	58
6.3.1. Network Communication	58
6.3.2. Disabling Sleep Mode on Monitor	61
7. Device Setting	62
7.1. AP Setting	62
7.1.1. AP Configuration	62
7.2. Detecting Setting	64
7.2.1. Detector Configuration	64
7.2.2. Detector Power Save Management	66
8. Troubleshooting	68
8.1. Failed to Turn the Detector On	68
8.2. Errors in Detector LED	68
8.3. The LINK LED does Not Turn on	69
8.4. Rapid Consumption of Battery	69
8.5. Battery Pack or Installation Part of Battery is Getting Hot	70
8.6. The Power Switch of SSU or Status LED is not working	70
9. Maintenance and Inspection	71
10. Specification	72
10.1. Main Specifications	72
10.1.1. EVS 2430Wi X-ray Detector	72

10.1.2.	Battery Charger System.....	73
10.1.3.	Battery Pack.....	74
10.1.4.	EVS-WPCS.....	75
10.2.	Charateristics.....	76
10.3.	Packing.....	77
10.3.1.	Product Configuration List.....	77
10.3.2.	Assemble Package.....	78
10.3.3.	Detector Panel Package.....	79
10.3.4.	Component Box Assemble Package.....	80
10.3.4.1.	AP Box Component.....	80
10.3.4.2.	Battery Box Component.....	80
11.	Regulatory Information.....	81
11.1.	Radio Frequency(RF) Compliance Information.....	81
11.2.	Labels and Marking on the Equipment.....	83
11.2.1.	Detector.....	83
11.2.2.	Battery Charger and Battery Pack.....	85
11.2.2.1.	Battery Charger.....	85
11.2.2.2.	Battery Pack.....	85
11.2.3.	EVS-WPCS.....	86
11.2.4.	Symbol Description.....	87
11.3.	Guidance and Manufacturer's Declaration for EMC.....	88
12.	Warranty.....	92

Safety notices

The following safety notices are used to emphasize certain safety instructions. Follow the safety instructions in this User's Manual along with warning and cautions symbols. Ignoring such warnings or cautions while handling the product may result in serious injury or accident. It is important for you to read and understand the contents of this User's Manual before attempting to use the product.



This notice is used to identify conditions under which improper use of the product may cause death or serious personal injury.



This notice is used to identify conditions under which improper use of the product may cause minor personal injury.



This notice is used to identify conditions under which improper use of the product may cause property damage.



Prohibited

This is used to indicate a prohibited operation.



This is used to indicate an action that must be performed.



This is used to indicate important operations and restrictions. Be sure to read this notice to prevent property damage or malfunction.







This is used to indicate operations for reference and complementary information. Users are recommended to read this notice.

1. Safety Information

1.1. Safety precautions

Follow these safety guides and properly use the equipment to prevent injury and damage to any equipment/data.

 <h1 style="margin: 0;">WARNING</h1>	
<h3>Installation and environment of use</h3>	
 <p>Prohibited</p>	<ul style="list-style-type: none"> - Do not use or store the equipment near flammable chemical such as alcohol, thinner, benzine, etc. If chemicals are spilled or evaporated, it may result in fire or electric shock through contact with electric parts inside the equipment. Also, some disinfectants are flammable. Be sure to take care when using them. - Do not connect the equipment to anything other than specified connectoins. Doing so may result in fire or electric shock.
<h3>Power supply</h3>	
 <p>Prohibited</p>	<ul style="list-style-type: none"> - Do not operate the equipment using any type of power supply other than the one indicated on the rating label. Otherwise, it may result in fire or electric shock. - Do not handle the equipment with wet hands. You may experience an electric shock that could result in death or serious injury. - Do not place heavy object such as medical equipments on cables and cords, or do not pull, bend, bundle, or step on them. These precautions are required to be followed to prevent sheathes of cables and cords from being peeled. Do not alter the cables and cords. Doing so may damage the cords which could result in fire or electric shock. - Do not supply power to more than one of equipment using the same AC outlet. Doing so may result in fire or electric shock. - Do not turn on the system power when condensation has formed on the equipment. Doing so may result in fire or electric shock. - Do not connect multiple portable socket-outlets or extension cords to the system. Doing so may result in fire or electric shock. -
	<ul style="list-style-type: none"> - Securely plug the power cord into the AC outlet. If contact failure occurs, or if dust or metal objects come into contact with the exposed metal prong of the plug, fire or electric shock may result. - Be sure to turn OFF the power to each of equipment before connecting or disconnecting the cords. Otherwise, you may get an electric shock that could result in death or serious injury. - Be sure to hold the plug or connector to disconnect the cord. If you pull the cord, the core wire may be damaged, resulting in fire or electric shock.



WARNING

Handling

The system, in whole or in parts, cannot be modified in any ways without any written approval from DRTECH.



Prohibited

- **No modification of this equipment is allowed**
- **Never disassemble or modify the equipment.**
Doing so may result in fire or electric shock. Also, since the equipment incorporates parts that may cause electric shock as well as other hazardous parts, touching them may cause death or serious injury.
- **Do not place anything on top of the equipment.**
The object may fall and cause an injury. Also if metal objects such as needles or clips fall into the equipment or if liquid is spilled, may result in fire or electric shock.
- **Do not hit or drop the equipment.**
The product may be damaged if it receives a strong jolt. Using a damaged equipment without repair may result in fire or electric shock.
- **Do not touch connector or inside of access cover.**



- **Have the patient take a fixed posture and do not let patient touch the parts unnecessarily.**
If a patient touches connectors or switches, it may result in electric shock or malfunction of the equipment.

When a problem occurs



- **If any of the following problems occur, immediately turn OFF the power to each piece of equipment, unplug the power cord from the AC outlet, and contact your sales representative or local DRTECH dealer:**
When there is smoke, when an odd smell or abnormal sound occurs.
When liquid has been spilled into equipment or metal object has entered through an opening.
When the equipment was dropped and damaged.

Maintenance and inspection



Prohibited

- **When the equipment is going to be cleaned, be sure to turn OFF the power of each equipment, and unplug the power cord from the AC outlet. Never use alcohol, benzene, thinner or any other flammable cleaning agents.**
Otherwise, it may result in fire or electric shock.



- **Clean the plug of the power cord periodically by unplugging it from the AC outlet and removing dust or dirt from the plug. Clean the peripherals and AC outlet with a dry cloth.**
If the cord is kept plugged in for a long time in a dusty, humid or a sooty place, objects around the plug will attract moisture, and this could cause insulation failure that could result in a fire.
- **For safety reasons, be sure to turn OFF the power to each piece of equipment when the inspections indicated in this manual are going to be performed.**
Otherwise, electric shock may occur.



WARNING

Battery pack and charger

- Do not use the battery pack as a power source for equipment other than EVS 2430Wi detectors. Be sure to use only the dedicated battery pack for the EVS 2430Wi detector.
- The battery charger is designed for the dedicated battery pack. Do not use the battery charger other than the dedicated one. Otherwise, a battery explosion or a battery leak may occur, resulting in fire or electrical shock.
- Do not operate the battery charger using any type of power supply other than the one indicated on the rating label.
- Do not handle the product with wet hands.
- Do not attempt to disassemble, alter, or apply heat to the product.
- Avoid dropping or subjecting the product to severe impacts. To avoid the risk of injury, do not touch the internal parts of the battery if it has been cracked.
- Stop using the battery pack immediately if it emits smoke, a strange smell, or otherwise behaves abnormally.
- Do not let the battery pack and battery charger come into contact with water or other liquids and do not allow them to get wet.
- Do not clean with substances containing organic solvents such as alcohol, benzene, thinner, or other chemicals. Otherwise, fire or electrical shock may occur.
- Do not allow dirt or metal objects (such as hair pins, clips, staples or keys) to contact the terminals. Otherwise, battery explosion or leakage of electrolyte may occur, resulting in fire, injury or pollution of surrounding area. If the battery leaks and the electrolytes come into contact with your eyes, mouth, skin or clothing, immediately wash it away with running water and seek medical attention.
- Do not leave, store, or place the product in a location near heat sources, or in a place subject to direct sunlight, high temperature, high humidity, excessive dust, or mechanical shock. Otherwise, battery leakage, overheating or damage to the product may occur, resulting in electrical shock, burns, injury or fire.
- Do not attempt to use a battery pack that has deteriorated. Using a battery pack that has exceeded its life cycle may lead to overheating, fire or explosion.
- The Lithium ion/polymer battery is recyclable.
- Battery slowly discharges even if not in use.
- The useful battery life can expire if it discharges immediately after being fully charged. You can purchase an optional battery pack to replace an exhausted one.
- The battery pack is a consumable item. If a fully charged battery is consumed quickly, use a new and fully charged battery pack.
- Be sure to charge the battery periodically (once a year) if it is not used for an extended period of time. The battery pack cannot be charged if it has been over discharged.
- Before discarding the battery pack, cover the terminals with adhesive tape or other insulators. Contact with other metal materials may cause fire or explosion.
- Remove battery pack from equipment which is unused for a few minutes to prevent discharge .



WARNING

Installation and environment of use



- **Do not install the equipment in any of the locations listed below. Doing so may result in malfunction, equipment failing, fire or injury.**
 - Close to facilities where water is used.
 - Where it may be exposed to direct sunlight.
 - Close to the air outlet of an air-conditioner or ventilation equipment.
 - Close to a heat source such as a heater.
 - Where the power supply is unstable.
 - In a saline or sulfurous environment.
 - Where temperature or humidity is high.
 - Where there is freezing or condensation.
 - In areas prone to vibration.
 - On an inclined surface or in an unstable area.
- **Because the equipment cable is long, take care that cables do not become tangled during use. Also, be careful not to get your feet caught in the cable.**
Otherwise, it may cause a malfunction of the equipment or injury of the user due to tripping over the cable.

Power supply



- **Always connect the three-core power cord plug to a grounded AC power outlet.**
- **To avoid the risk of electric shock, this equipment must only be connected to a power supply that maintains protective earth”.**
- **To make it easy to disconnect the plug at any time, avoid putting any obstacles near the outlet. Otherwise, it may not be possible to disconnect the plug in an emergency.**
- **Be sure to ground the equipment to an indoor grounded connector. Also, be sure to connect all the earth connections for the system to a common ground.**
- **Do not use any power source other than the one provided with this equipment.**
Otherwise, fire or electric shock may be caused due to leakage.
- **The product has lower breaking capacity type. So do not install at the building power system prospective short-circuit current exceeding 35A**

Handling



- **Do not spill liquid or chemicals onto the equipment. In cases when the patient is injured, do not allow liquid or chemicals to come in contact with blood or body fluids.**
Doing so may result in fire or electric shock.
In such a situation, protect the equipment with a disposable covering as necessary.
- **Turn OFF the power to each piece of equipment for safety when not being used.**

CAUTION

Handling the equipment

The Equipment must be handled with care to avoid personal injury or damage to the internal image sensor.



- Handle the equipment carefully.
- Do not submerge the equipment in water.
- The internal image sensor may be damaged if something hits against it, or if it is dropped, or receives a strong jolt.

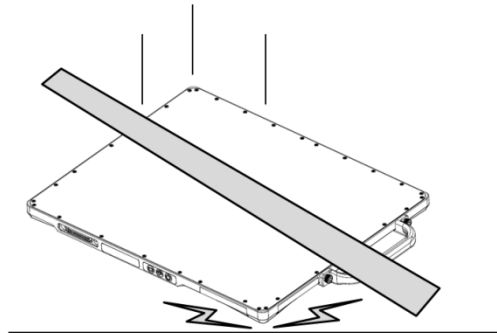

- Do not place excessive weight on the detector.
Otherwise, the internal image sensor may be damaged.

<Load Limit>

Uniform load: 150 kg over the whole area of the detector

Local load: 100 kg on an area of 40 mm in diameter

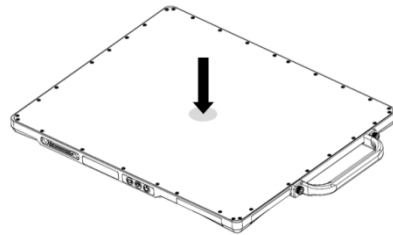
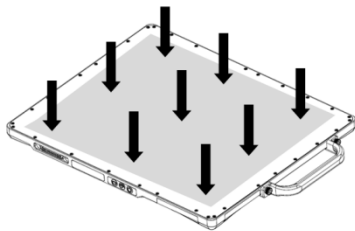

- Be sure to use the detector on a flat surface that does not bend.
Otherwise, the internal image sensor can be damaged.
- Be sure to securely hold the detector while using it in upright positions.
Otherwise, the detector may fall over, resulting in injury to the user or patient, or may flip over, resulting in damage to the inner device.

1.2. Notes for using the equipment

When using the equipment, take the following precautions. Otherwise, problems may occur and the equipment may not function correctly.

System Diagnostic

- The Ecali1 software runs a system diagnosis.
- Run Ecali1 software after installing the system, at least once a year. If an error occurs, report the detailed error information to DRTECH local dealer or distributor.



CAUTION

The owner is responsible for ensuring that the system diagnostic is performed every year.
Do not try to use the system if the system diagnosis failed.

Calibration

- To ensure optimal performance of the system, it is important to verify that the system is calibrated.
- You can process calibration with the calibration data CD (provided).



CAUTION

The owner is responsible for ensuring that the system calibration is performed whenever the system installation is completed or the system is repaired. Do not try to use the system if system calibration is not performed.

Before exposure

- Be sure to check the equipment on a daily basis and confirm that it works properly.
- Suddenly heating the room in cold area will cause condensation to form on the equipment. In this case, wait until the condensation evaporates before performing an exposure. If the equipment is used while the condensation forms, problems may occur in the quality of captured images. When an air-conditioner is used, be sure to raise/lower the temperature gradually so that a significant change in temperature in the room and in the equipment does not occur, to prevent condensation.

During exposure

- Do not use the selected frequency channel (2.4GHz and 5GHz dual band) for other wireless devices. Mutual interference may affect the image data transmission rate.
- Do not use the detector near devices generating a strong magnetic field. Doing so may produce image noise or artifacts.

Image Backup

- To avoid missing images which might result in patient being exposed to additional doses of radiation, it is important to send the images to PACS or back up the images by filming or by using external storage devices such as CD, DVD, HDD, USB, etc.. This should be done as a routine operation for every patient. If the hard disk of your workstation is about to full, the operator should backup images and manually delete the images as administrator to make room on the hard disk for new images.

User Limitation

- The Ecali1 software has the technician mode which could only be operated by inputting the correct PASSWORD. The technician mode should be operated by the personnel who are qualified by DRTECH.

Electric Shock Hazards

- To reduce electric shock hazards, the system must be connected to an electrical ground.
- A three-contact conductor AC power cable is supplied with this system to provide the proper electrical grounding. The power cable must be plugged into an UL-approved three-contact electrical outlet.
- Do not disassemble or modify the product as it may result in fire or electric There are no serviceable parts inside equipments and adjustments should not be made. Only trained and qualified personnel should be permitted access to the internal parts of the system.
- To reduce electric shock hazards, product is required to be well insulated with the use of appliance coupler, mains plug, and other seperable connections.

Disinfection and cleaning

- Wipe it with a dry cloth slightly damed with a neutral detergent.
- Do not use solvents such as alcohol, thinner or benzene. Doing so may damage the surface of the equipment.
- Do not clean the system while the power is on.

Operating/storage environment

- Be sure to use and store this equipment under the conditions described below:

	Temperature	Humidity	Atmospheric pressure
Operating environment	10 to 35 °C	30 to 85 % RH	700 to 1060 hPa
Transportation & Storage environment	-10 to 40 °C	5 to 95 % RH	500 to 1060 hPa

- Do not expose this equipment to high temperatures and/or high humidity. Malfunction can occur.
- When not in use, keep the detector, handle unit, and grid in a designated location or in a location where they are safe and cannot fall down.

Notes on disposal

- Disposal of this product in an unlawful manner may have a negative impact on health and on the environment. Therefore, when disposing this product, be absolutely sure to follow the procedure which complies with the laws and regulations applicable in your area.
- The expected life span of EVS 2430Wi system is about 3 years.

Handling the equipment

- The equipment must be handled with care to avoid personel injury or damage to the internal image sensor.
- The EVS 2430Wi Wireless is an advanced wireless digital radiographic equipment in the DRTECH Exprimer series. This equipment is designed to provide the highest resolution and sensitivity in the series. In addition, the wireless LAN (IEEE 802.11n*) communication feature improves the operability, and high-speed processing.

2. Introduction

2.1. Features

- Wireless LAN communication (IEEE 802.11n*) includes a lightweight and thin detector that is easy to handle.
- The shape of the detector, which is identical to that of a conventional film cassette complying with ISO4090, enables digital radiography to apply to the existing analog radiography configuration.
- The new sensor with 76 μm of pixel pitch and CsI (Cesium Iodide), Gadox (Gadolinium Oxysulfide) used for the scintillator produces high resolution (approx. 11.8 Mega pixels) digital images within the effective imaging area (223 x 291 mm), with low doses of X-rays.
- Depending on the operating conditions at each site, the wiring unit (optional) enables the equipment to be used through expansion to a wired connection.
 - ✓ At the time of installation, set a specific channel in the frequency band of 5.0 GHz before using the LAN. Note that the available frequency band for this standard varies, depending on the local radio laws, regulations and system requirements.

✓

✓

Intended Use

The EVS 2430Wi of Flat Panel Digital X-ray detector for industry was designed for industrial use.

Intended conditions of use

Considerations	Condition
Environment including hygienic requirements	<ul style="list-style-type: none"> ● Operating conditions <ul style="list-style-type: none"> - Temperature: 10 °C to +35 °C - Barometric Pressure: 700 hPa to 1060 hPa - Humidity: 30 % R.H. to 85 % R.H. ● Storage and delivery conditions <ul style="list-style-type: none"> - Temperature: -10 °C to +40 °C - Barometric Pressure: 500 hPa to 1060 hPa - Humidity: 5 % R.H. to 95 % R.H. ● Non-sterile ● Less than ten minute contact ● Ambient luminance range: 100 lx to 1500 lx ● Viewing angle: normal to the display ± 20°

2.2. System Configuration

2.2.1. Basic Configuration

Generally, the EVS 2430Wi detector is used in system configuration as illustrated below:

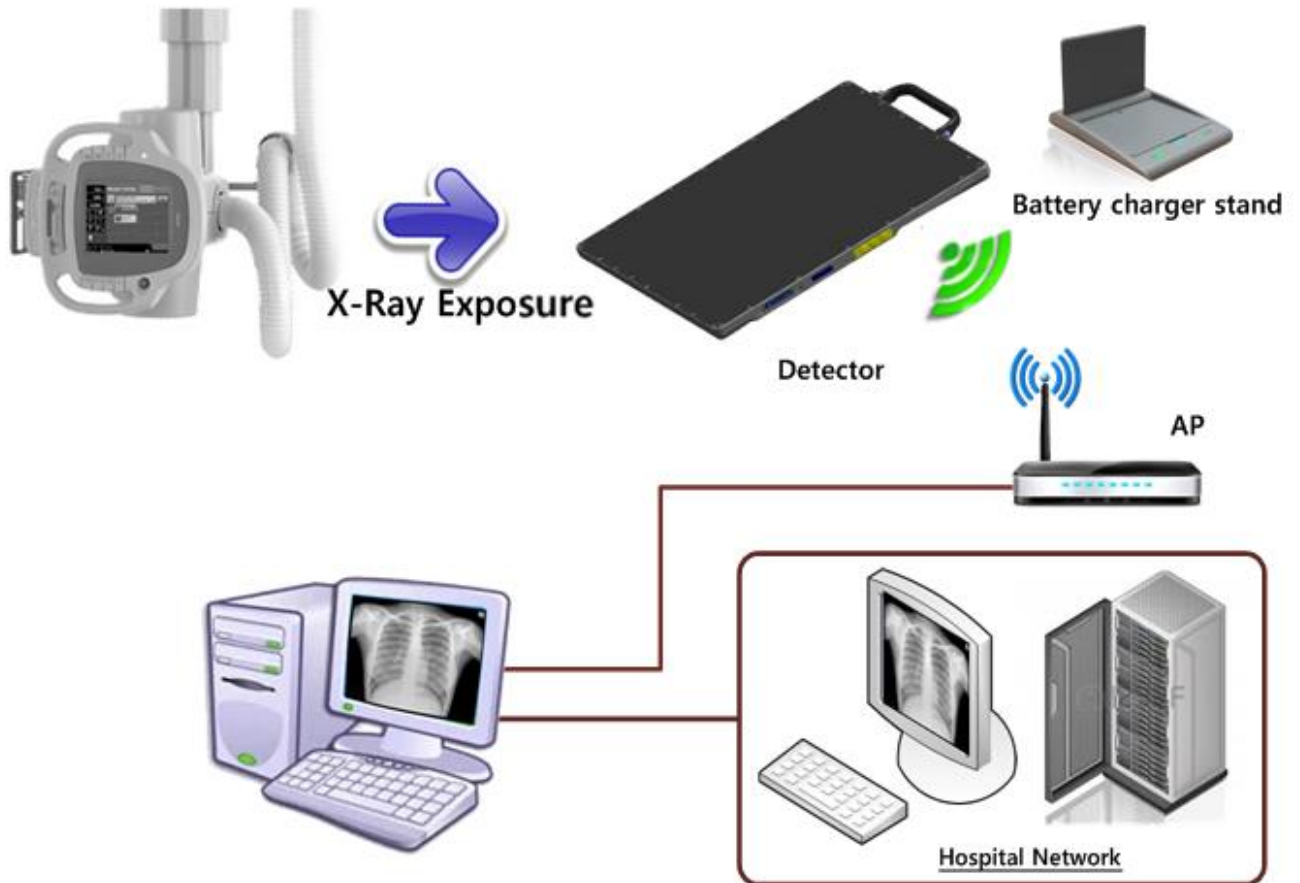

Figure 2.1 EVS 2430Wi System Configuration

Wireless Connection

- **EVS 2430Wi** wireless detector transmits images and data by wireless communication.
- A battery pack should be installed in the detector to use it under the wireless configuration.
- Up to 2 battery packs can be charged simultaneously from a battery charger.



- Use of multiple WLAN devices within the same frequency band may cause interference within each wireless communication and slow down the transmission speed
- Do not cover or block the wireless module of the detector. Otherwise, the transmission speed or operable distance may reduce.
- Recommended maximum operating distance of wireless communication, between the detector and Access Point (AP), is 8 meters.

Wired Connection

- Connect **EVS 2430Wi** wireless detector and SSU / or Functional cable with a tether interface cable to make a wired configuration.
- As the tether interface cable supplies power, a battery pack is not needed to be inserted in the detector.





The wired connection is more suitable for stabilized communication when the detector is set in a bulky stand or on a table.

- The data communication is faster than the wireless connection.
- It enables the battery pack to be continuously supplied with power while using the detector.
- The time for charging and replacing the battery pack can be reduced drastically.

EVS 2430Wi Wireless system consists of detector, system synchronization unit (SSU), CDs and relevant accessories.
 (Refer to chapter 3-1 "Product Components" for CD information)

Table 2.1. EVS 2430Wi Packaging

X-ray Detector (EVS 2430Wi)	Battery Charger (EVS-BCS)	Battery Pack (EVS-MBP-Y)
		
Wireless Charging System : Optional	Power adaptor (12V, 7.08A) + AC Power Cable(2m)	LAN Card(PCle Giga-bit LAN) LAN Cable (CAT.7, 15m)
		
Access Point (TP-LINK TL-WDR4300)	Tether Interface(3m) : Optional	Functional cable (0.5 m) + Power Adaptor: Optional
		

<p>USB Switch Box Options</p> <ul style="list-style-type: none"> - USB Switch Box - Hand Switch - USB Cable(1m) - Generator Cable(1.2m) 	<p>CD(Software / Calibration)</p>	<p>User's Manual (Hard Copy)</p>
		<p>DRTECH EVS 3643 System. <i>Safety and Regulatory Information.</i> <i>with User's Manual.</i></p>  <p>DRTECH <small>DRTECH</small></p>

3. Product Description

3.1. Product Components

3.1.1. Auto Trigger Mode (AT Mode)

Table 3.1. Product componets for Auto Trigger Mode

Part name	Remark
Flat panel detector	EVS 2430Wi(Scintillator : Csl : TI) 1.9 kg
	EVS 2430GWI(Scintillator : Gadox) 1.9 kg
Battery charger	EVS-BCS : 0.5 kg
Battery pack	EVS-MBP-Y : 0.24 kg
Wireless Charging System	EVS-WPCS : 0.15 kg
CD (Software / Calibration)	Document : User 's Manual (PDF) Calibration Data : MAP, PMP, GMP Software : Econsole1, Ecali1
User's Manual	Supported in all Modes
License Dongle Key (USB)	Needed for activating Econsole1
Tether Interface Cable (3m)	Supported in all Modes
LAN Cable (15m)	Supported in all Modes
AC Power Cable (2m)	Supported in all Modes



WARNING

The use of accessories and cables other than those specified, with the exception of **EVS 2430Wi Wireless** accessories and cables sold by DRTECH Co., LTD. as replacement parts for internal components, may result in increased emissions or decreased immunity of the equipment. Accessory equipment connected to the analog and digital interfaces must be certified according to the respective IEC standards. All combinations of equipment must be in compliance with IEC 60601-1-1 system requirements. Any person who connects additional equipment to the signal input or signal output ports configures a medical system, and is therefore responsible for ensuring that the system complies with the requirements of the system standard IEC 60601-1. If in doubt, consult DRTECH technical support representative.

3.1.2. Synchronization Trigger Mode (Sync. Mode)

Table 3.2. Product componets for Synchronization Trigger Mode

Part name	Remark
Flat panel detector	EVS 2430Wi(Scintillator : Csl : TI) 1.9 kg
	EVS 2430GWI(Scintillator : Gadox) 1.9 kg
Battery charger	EVS-BCS : 0.5 kg
Battery pack	EVS-MBP-Y : 0.24 kg
Wireless Charging System	EVS-WPCS : 0.15 kg
CD (Software / Calibration)	Document : User 's Manual (PDF) Calibration Data : MAP, PMP, GMP Software : Econsole1, Ecali1
User's Manual	Supported in all Modes
License Dongle Key (USB)	Needed for activating Econsole1
Tether Interface Cable (3m)	Supported in all Modes
LAN Cable (15m)	Supported in all Modes
AC Power Cable (2m)	Supported in all Modes
Generator Cable (15m)	Supported in Sync. Mode

3.1.3. USB SW Mode

Table 3.3. Product componets for USB SW Mode

Part name	Remark
Flat panel detector	EVS 2430Wi(Scintillator : Csl : TI) 1.9 kg
	EVS 2430GWI(Scintillator : Gadox) 1.9 kg
Battery charger	EVS-BCS : 0.5 kg
Battery pack	EVS-MBP-Y : 0.24 kg
Wireless Charging System	EVS-WPCS : 0.15 kg
USB Switch Box	EVS-USB01 Supported in USB Mode
CD (Software / Calibration)	Document : User 's Manual (PDF) Calibration Data : MAP, PMP, GMP Software : Econsole1, Ecali1
User's Manual	Supported in all Mode
License Dongle Key (USB)	Need for Econsole1
Hand Switch	Supported USB Mode
Tether Interface Cable (3m)	Supported in all Modes
Extension Tether Cable (7m)	Supported in all Modes
LAN Cable (15m)	Supported in all Modes
AC Power Cable (2m)	Supported in all Modes
USB Cable (1m)	Supported in USB Mode
X-ray Cable (3m)	Supported in USB Mode

3.1.4. Workstation (Recommended and minimum but NOT included)

Table 3.4. Workstation

Item	Specification
Operating system	Windows 7 64 bit SP1 (Professional Edition or higher)
CPU	Intel Core i5 2600 or higher (or compatible CPU)
Memory	4GB or higher
Hard disk	1TB or higher
LAN card	Gigabit (Detector only) Intel® PRO 1000 Series (Gigabit LAN Card for network interface) Min. Requirements : 1Gbps Jumbo Frames : 9K Receive Descriptors : 2K (higher than 1024) This is not dedicated to DICOM
Monitor	1024 x 768 or higher
Optional disc drive	CD or DVD R/W

3.1.5. Grid (Recommended but Not included)

Table 3.5. Grid specifications

Item	Description
SID	100 / 130 / 150 / 180 cm
Ratio	10 : 1
Frequency	125 Line/inch
Inter spacer	AI

3.2. X-ray Imaging Condition

- **X-ray Energy Range**

40kVp to 150kVp

- **Reliability (Lifetime Dose)**

More than 74Gy (35uGy x 365days x 24hours x 60minutes x 60seconds/15sec)

4. Components and Specifications

4.1. Detector

4.1.1. Detector Specification

Table 4.1. Detector Specifications

Item	Description
Model	EVS 2430Wi / EVS 2430GWI
Purpose	General Radiography
Pixel Pitch	76 μ m
Scintillator	CsI (Cesium Iodide) / Gadox (Gadolinium Oxysulfide)
Image Matrix Size	3072 \times 3840 pixels
Effective Imaging Area (H \times V)	233 x 291 mm
Image Acquisition and Transfer Time	< 5 sec.
Spatial Resolution	Min. 6.5 line pair/mm
Rated Power Supply Wireless (Maker/Mode name/Rating) Wired (Maker/Model name/Rating)	Powered by the battery pack (DRTECH Corporation(Powerlinx) / EVS-MBP-Y /7.4V, 4000 mAh) Powered by Power adopter using tether interface (XP Power / AHM85PS12 / DC12V 7.08A)
Power Consumption	Max. 24 W
Network Interface	Gigabit
Dimensions (mm) [±0.5 mm]	267.5 (H) \times 327.5 (V) \times 14.9 (D)
Weight	1.8 kg
Environmental Requirements	
Operational	Temperature: +10 to +35°C Humidity: 30 to 85% RH (Without Condensing) Atmospheric pressure: 700 to 1060 hPa
Storage and Transportation(unpacked)	Temperature: 0 to +40°C Humidity: 10 to 90% (Without Condensing) Atmospheric pressure: 500 to 1060 hPa

†Tether Interface:

Allows the detector to communicate with SSU via Ethernet cabling when wireless communications is not available or when higher speed data transfer is necessary

4.1.2. Detector Component

The detector is designed to capture radiographic images.

Captured images are transmitted to the EVS 2430Wi image-capture computer using the wireless/wired data transfer

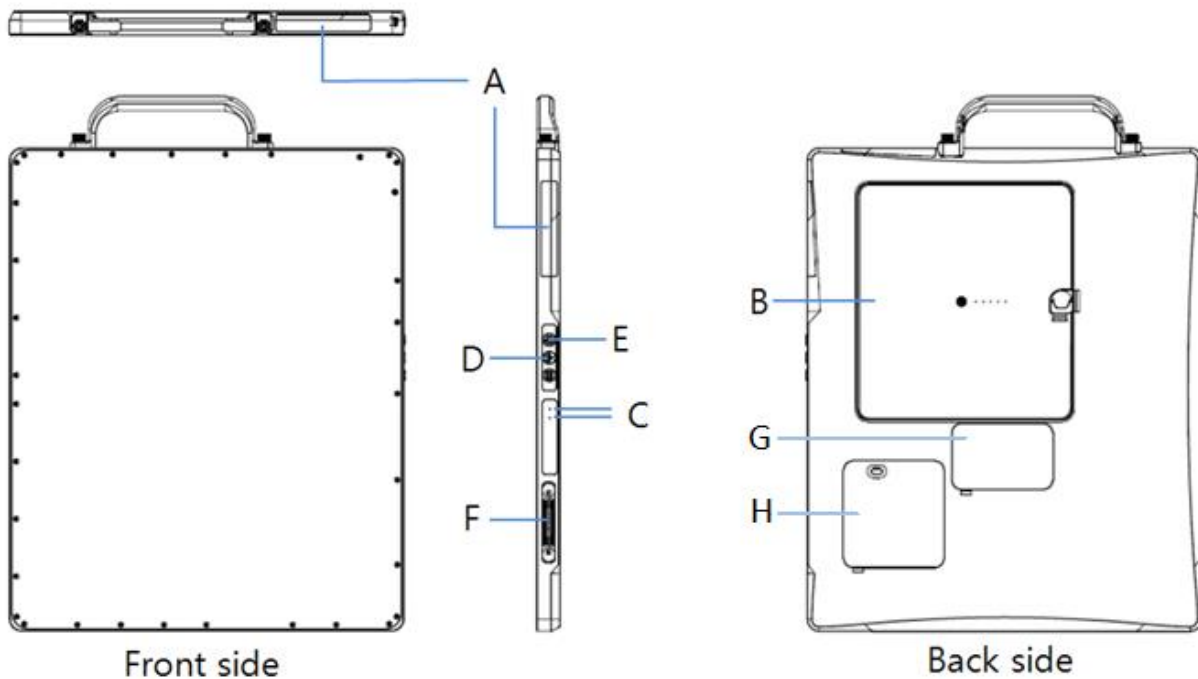

Figure 4.1. Detector Components

- A. Wireless antenna : Transmits image data with wireless communication (IEEE802.11n).
- B. Battery Pack : Supplies electrical power to the detector while using wireless communication
- C. Status indicators
 - Power : Shows power on/off status of the detector.
 - Ready : Shows data communication status and ready status of detector
(Lights on indicates that detector is busy, lights off means detector is ready)
 - Link : Shows detector's registration and connection status.
 - AP : Lamp indicating Wired/ Wireless mode (2.4 GHz / 5 Hz)
- D. AP Button: Can register detector among different wireless connection options.
(Connection options: Wireless using AP/ Wireless using detector's internal AP/ Portable mode)
- E. Power Button : Turns Detector on / off
- F. Connector : Data communication and power supplying through tether cable
- G. Debugging Cover
- H. WPCS Window : Wireless Charging Rx Window



WARNING

Don't remove G and H. if metal objects come into case, it can lead to product malfunction..
The operator should not contact the inside of the access cover(G and H)

4.2. Battery Charger and Battery Pack and Adaptor

4.2.1. Battery Charger

4.2.1.1. Battery Charger Specifications

Table 4.2. Battery Charger Specifications

Item	Description
Model	EVS-BCS
Simultaneous Charging	Battery Pack 2 EA
Charging Time	3 hours
Rated Power Supply	DC +12 V, 6 A Max.
Dimensions (W x H x D)	180 mm x 255 mm x 35 mm
Weight	0.5 kg

4.2.1.2. Battery Charger Components

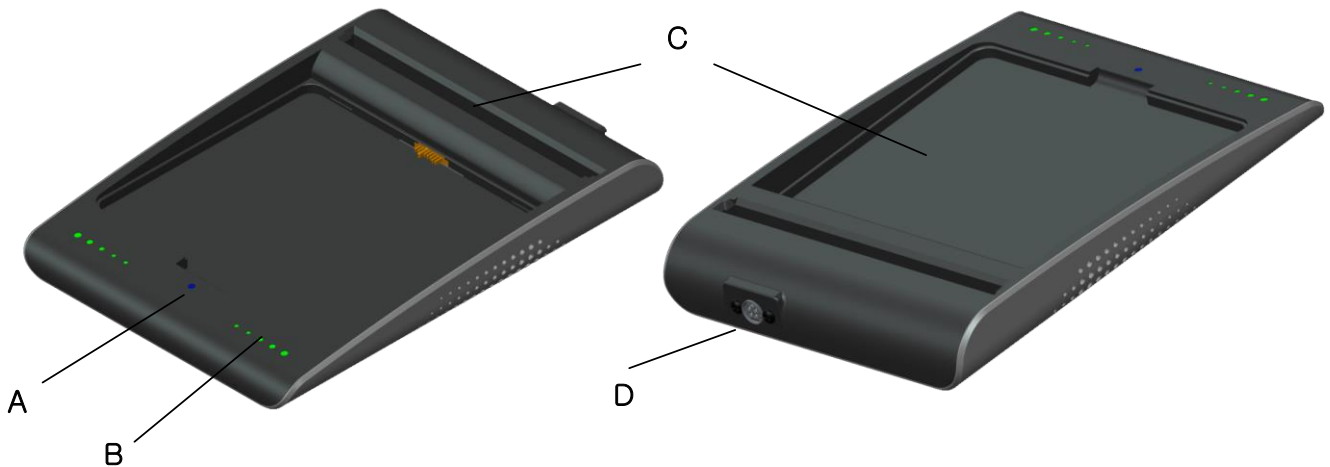

Figure 4.2. Battery Charger

- A. Power indicator : Indicates the power on/off status..
- B. Charging indicator : Indicates the charging status.
- C. Battery compartment : Insert the battery pack to charge.
- D. DC Input : Connect the DC adaptor to supply electrical power to the battery charger

4.2.2. Battery Pack

4.2.2.1. Battery Pack Specification

Table 4.3. Battery Charger Specifications

Item	Description
Model	EVS-MBP-Y
Cell Type	Lithium Polymer
Number of Cells	2S1P (2series 1 Parallel)
Rated Power Supply	Output : DC +7.4 V
Lifetime	Approx. 500 cycles of use (full charge to discharge is 1 cycle)
Dimensions (W x H x D)	163 mm x 148 mm x 7 mm
Weight	0.24 kg

4.2.2.2. Battery Pack Components

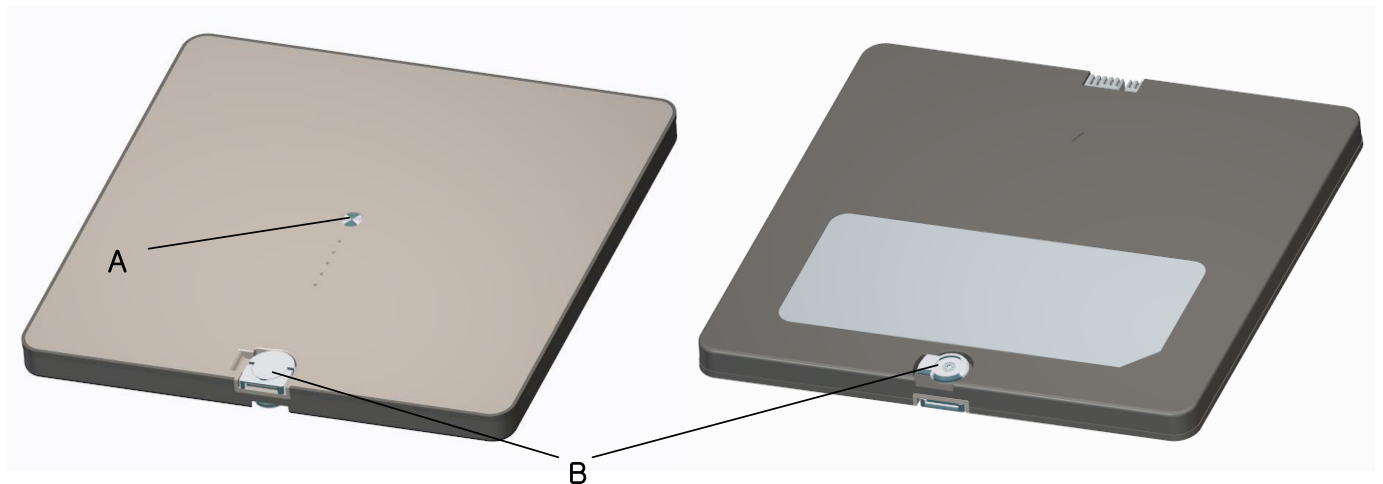

Figure 4.3. Battery Pack





- A. Charging indicator : Indicates the charging status
- B. Latch knob : Rotate between on/off for battery swap

4.2.2.3. Charging Battery Pack

The battery pack supplies power to the detector during wireless connection.

Be sure to use only the dedicated battery pack, and fully charge it before usage.

- Connect the power adapter to the DC Input port of the battery charger. The power LED lights in blue indicates the presence of direct current (DC) power.
- Insert the battery pack into the battery charger. Charging starts automatically. The charge LED lights appear green when the battery pack is being charged. When battery pack is completely charged, all levels of charge LEDs will illuminate.
- Gently pull the charged battery pack to remove from the battery charger.

	WARNING	Securely plug the power cord into the power source. If contact failure occurs, or if dust or metal objects come into contact with the exposed metal prongs of the plug, fire or electrical shock may occur.
	CAUTION	Be sure to stop charging the battery pack when the charge LED lights appear in green beyond the specified charging time. Not doing so may result in battery pack overheating or smoke emission, or battery explosion or fire.
	CAUTION	You must use the power adaptor that is certified with IEC 60950 or IEC 60601-1.
		Two batteries can be charged at the same time.
		It takes approximately two hours to fully charge a battery pack. The required charging time may vary depending on the temperature and remaining battery level.

4.2.3. Adaptor

Table 4.3. AD/DC Adaptor Specifications

Item	Description
Model	AHM85PS12
Rated input	100- 240V / 1.0A, 50/60Hz
Rated output	12V, 7.08A
Maker	XP POWER

4.3. Wireless Charging System

4.3.1. EVS-WPCS

4.3.1.1. EVS-WPCS Specifications

Table 4.4. EVS-WPCS Specifications

Item	Description	Note
Model	EVS-WPCS	
Dimensions (W x H x D)	115.8 mm x 94.8 mm x 12 mm	
Weight	0.15 kg	
Charging Transceiver IC	Freescale MWTC1012	Medium Power
Charging Receiver IC	Freescale MWPR1516	Medium Power
Tx Coil to Rx Coil	3mm	
Input Voltage	DC 12V ($\pm 1\%$) / more than 3A or Adaptor (XP Power / AHM85PS12 / DC12V 7.08A)	Tx Module Input
Output Power	DC 10V /1.4A (14W)	Rx Module Output
Standby Current/Power	27.22mA / 326.6mW	
Max Power Efficiency	83.2%	
Storage Temperature	-20°C to 85°C	
Operating Temperature	10°C to 35°C	
WPC Qi Specification	WPC MP-A2 Standard.	
	H/W & S/W Protection Algorithm.	

4.3.1.2. EVS-WPCS Components



Figure 4.4. EVS-WPCS

1. EVS-WPCS Base
2. IRDA Window : IRDA communication window.
3. Power Connection Cable
4. Debug Connector : for debugging
5. ID Switch : Device id setting dip switch.
6. Indicate LED Conntor : for cradle (Option)
7. Indicate LED Conntor : for system (Option)

4.3.1.3. TX / RX Module Specification

+ Tx Module

- PCB size : 55(mm)x45.5(mm)
- Coil size : 52.5(mm)x52.5(mm)
- Coil inductance : 11.7uH (MP A2)

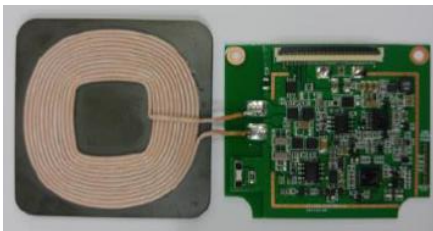

+ Rx Module

- PCB size : 65(mm)x47(mm)
- Coil size : 45.6(mm)x45.6(mm)
- Coil inductance : 7.3uH

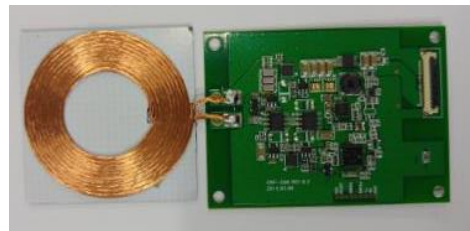

4.3.1.4. RX Module Components

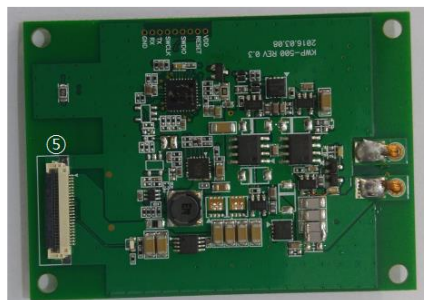

1. RX Module Base
2. Ferrite Sheet
3. Coil
4. IRDA : Communication for EVS-WPCS.

5. Connector : Power Output Connector.

4.3.1.5. EVS-WPCS Operations

EVS-WPCS variety of supports for the charging form.

- Cradle Charging Type
- Stand or Bed Bucky Charging Type
- Mobile Charging Type

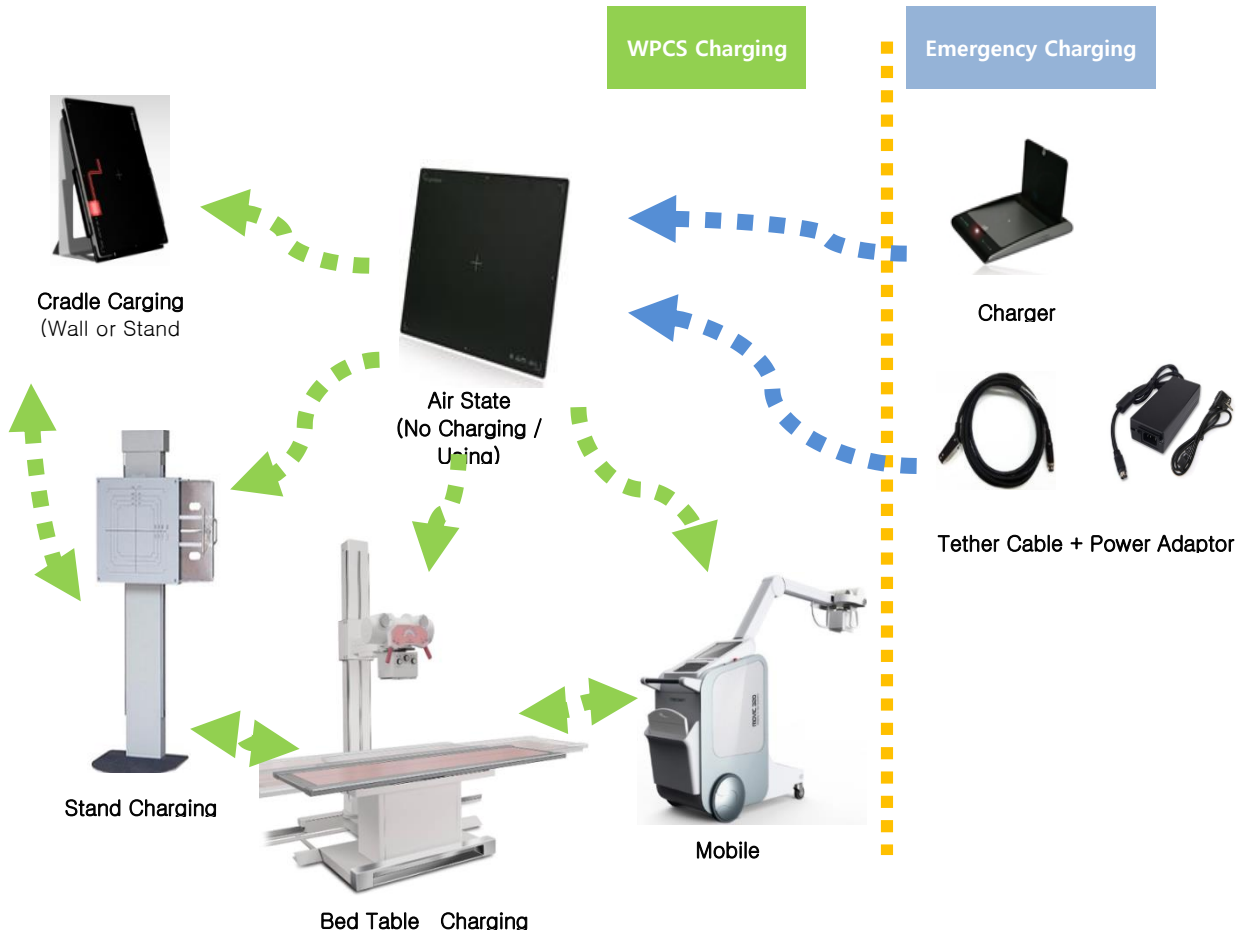

4.3.1.6. Attach Direction

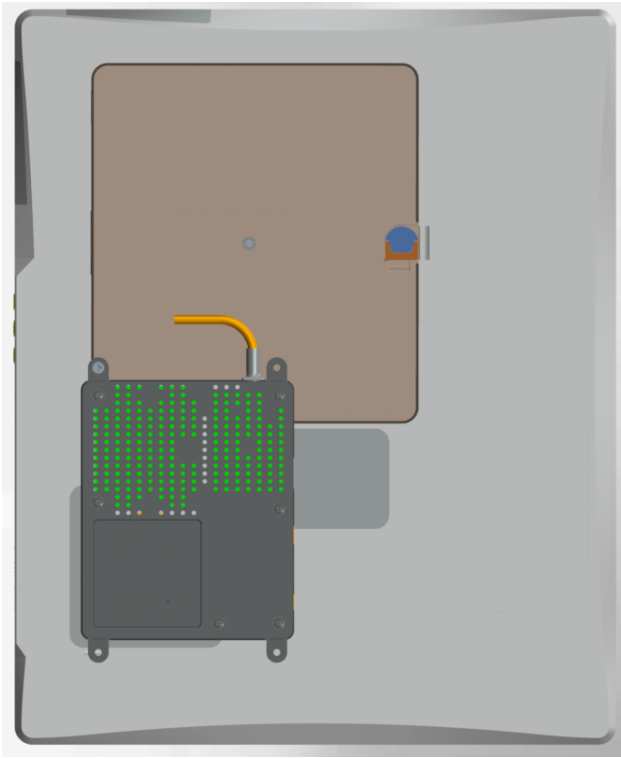

4.3.1.7. Indicator LED Connector Description

Num.	Connector Name	Remark
1	3.3V	Power Out
2	Indicator Control 1	
3	Indicator Control 2	
4	Indicator Control 3	
5	GND	

4.3.1.8. Indicator LED Connector Description (Isolation)

Num.	Connector Name	Remark
1	Indicator Control 1	
2	Indicator Control 2	
3	Indicator Control 3	
4	GND	
5	GND	

USER System

EVS-WPCS

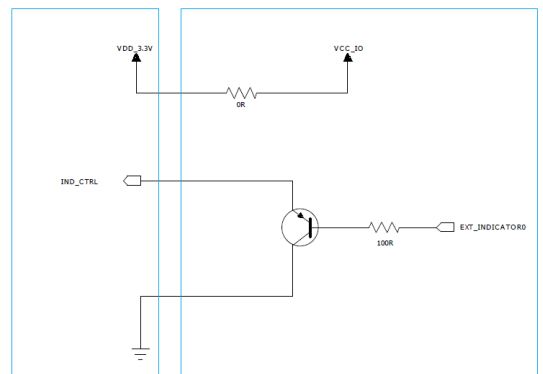
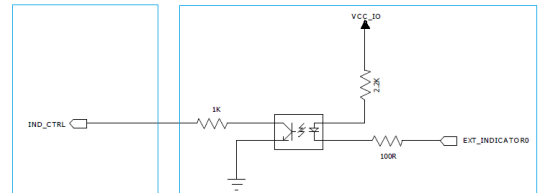

5. Operating Procedure

General Workflow

The following workflow indicates the procedures after startup of EConsole1 and other system equipments

5-1. Preparing to use the detector

Attach a fully-charged battery pack to the detector.

¹⁾ : A procedure in order to register the detector to a specific digital radiography system

5-2. Operating the detector

1. Turn on the detector

²⁾ : Network connection between the EVS 3643 wireless detector and the EConsole1

2. Register¹⁾ the detector and make connection²⁾ to the EConsole1 power supply to the detector

³⁾ :
 • Selection of EVS 3643 wireless from the Exprimer series detector
 • Selection of wireless/wired data transfer

3. Conduct Examination

• Select or register the patient information

Loop back procedure for each patient

• Select the protocol (selection³⁾ of the detector)
 - Arrange the patient in the correct posture
 - Position the X-ray generator to adjust the exposure field
 - Check all the conditions

Loop back procedure for each body part

Check the captured images
 • List the images
 • Transmit the images

Sterilize the portion of the detector that has been in contact with a patient

• Conduct the next examination

5-3. Ending use of the detector

1. Turn off the detector

2. Remove the battery pack

For details, refer to the operation manual or setup guide of the EConsole1

5.1. Preparing to Use the Detector

	<h3>CAUTION</h3>	<p>Be sure to use only the dedicated power supply for the EVS-2430Wi detector</p>
--	------------------	---

5.1.1. Standard Configuration

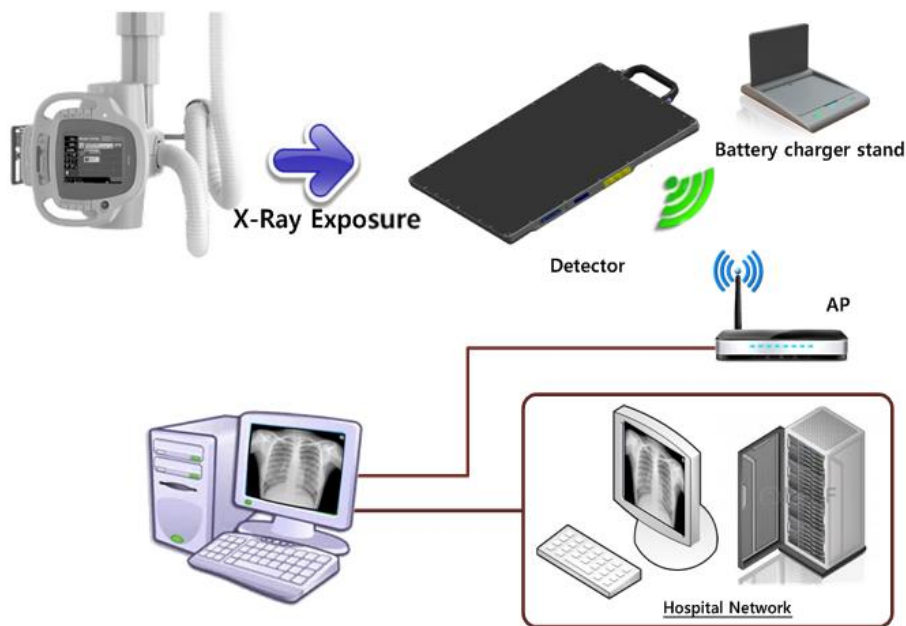

Figure 5.1 EVS 2430Wi System Configuration

A. Wireless Connection

- EVS 2430Wi transmits images and data by wireless communication.
- A battery pack should be installed in the detector to use it under the wireless configuration.
- Up to 2 battery packs can be charged simultaneously from a battery charger.



B. Wired Connection

- Connect EVS 2430Wi and PC with a tether interface & Functional cable to make a wired configuration.
- As the Functional cable supplies power, a battery pack is not needed to be installed in the detector.
- Data communications are faster than wireless connection.
- It is able to keep charging a battery pack while using the detector.

5.1.2. Battery Pack

**WARNING**

Securely attach the battery into the detector or charger. If contact failure occurs, or if dust or metal objects come into contact with the exposed connector pins of the detector or charger, fire or electrical shock may occur

5.1.2.1. How to Attach a Battery Pack

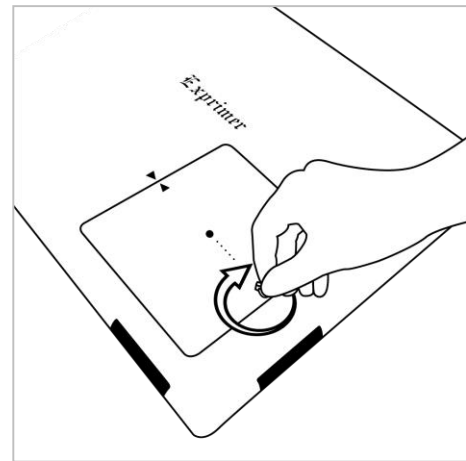
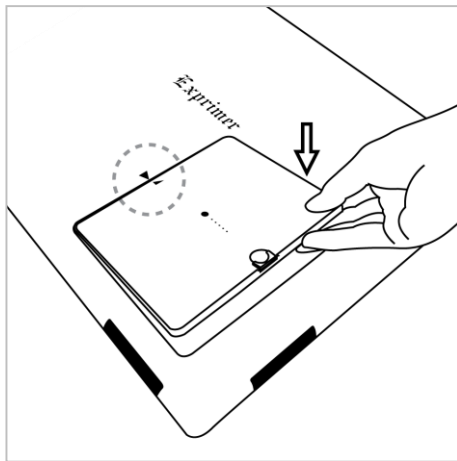

- 1) Align the arrows on the detector and battery pack.
- 2) Push down the battery pack.
- 3) Turn the battery lock knob 90 degrees clockwise.

5.1.2.2. How to Detach a Battery Pack

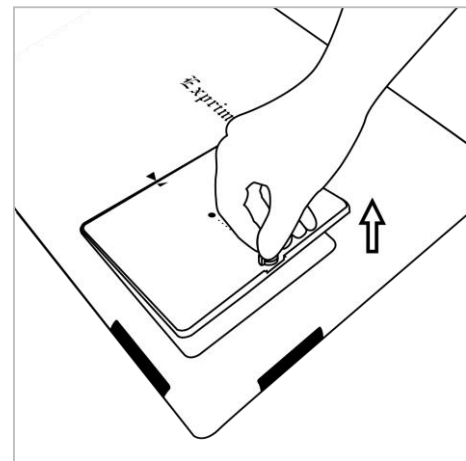
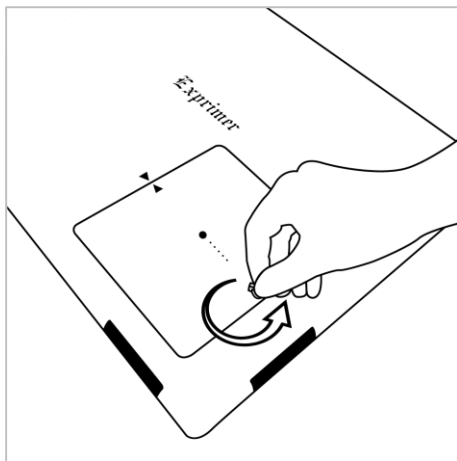

- 1) Turn the battery lock knob 90 degrees anti-clockwise.
- 2) Pull up the battery pack grabbing the knob.

**WARNING**

Make sure to turn off the detector before detaching a battery pack. Press and hold the **power** button for about 2 seconds. All status LED lamps turned off indicates the detector is turned off.

5.1.2.3. How to Charge Battery Packs

5.1.2.3.1. Horizontal Direction

5.1.2.3.1.1. Attachment

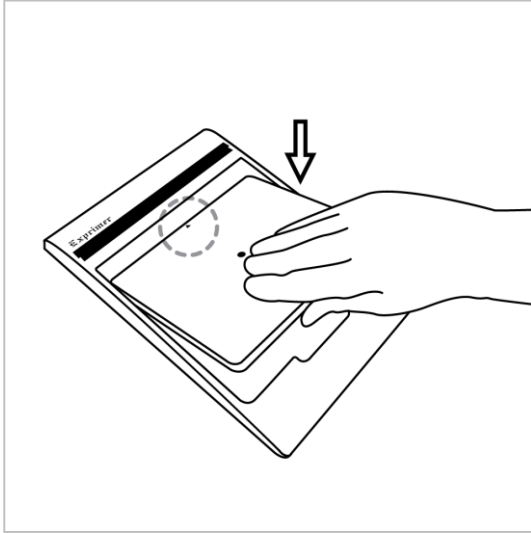

- 1) Align the arrows on the charger and battery pack.
- 2) Push down the battery pack.

5.1.2.3.1.2. Detachment

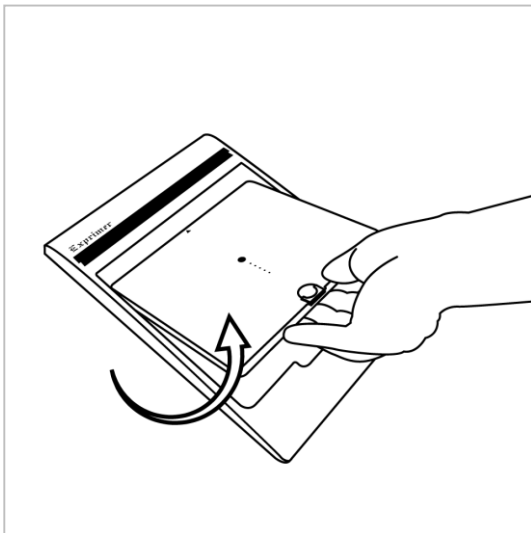

- 1) Put the finger into the groove on the charger and grab the battery pack.
- 2) Pull up the battery pack.

5.1.2.3.2. Vertical Direction

5.1.2.3.2.1. Attaching

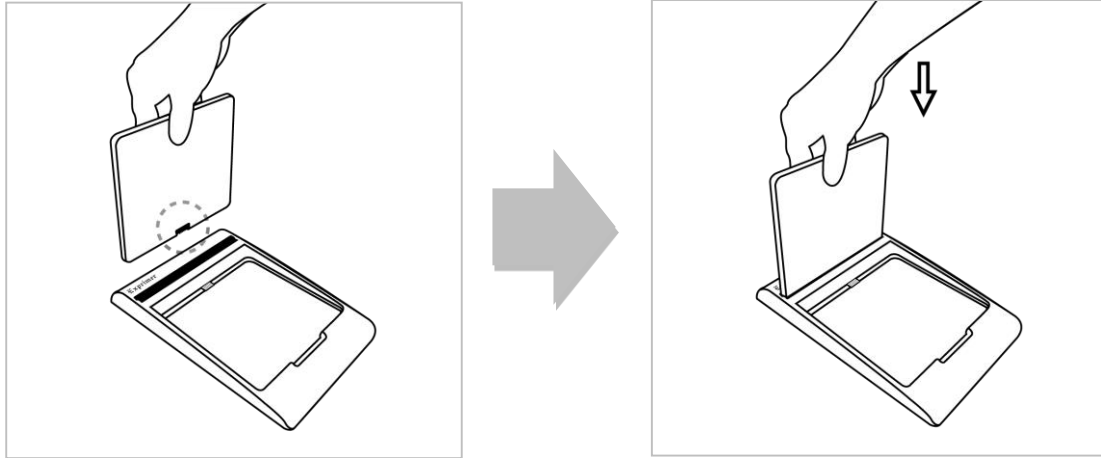

- 1) Stand the battery pack up to reveal the battery charged connector.
- 2) Align the left and right side of battery pack to the charger.
- 3) Push down the battery pack.

5.1.2.3.2.2. Detaching

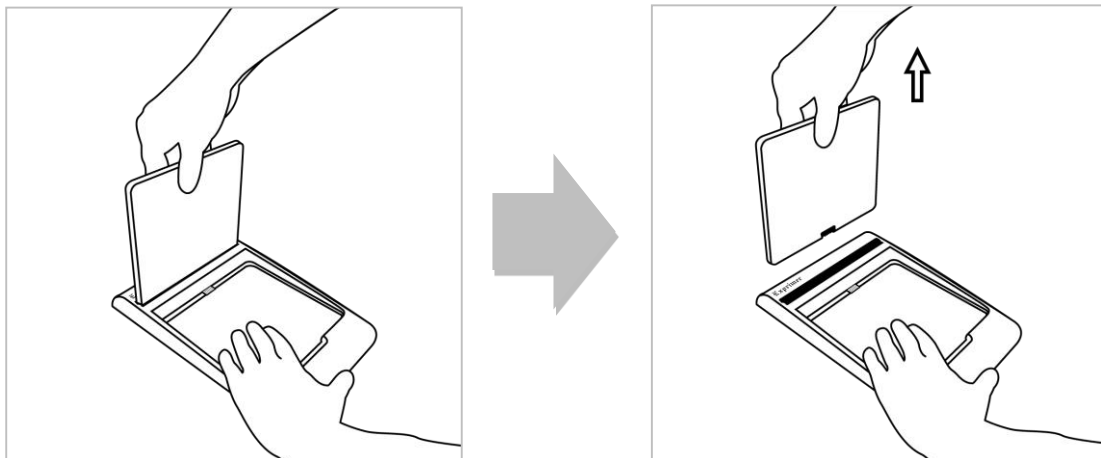

- 1) Grab the battery pack.
- 2) Pull up the battery pack and push down the charger.

5.2. Hardware Installation

5.2.1. Connecting Device

This section describes how to connect the EVS 2430Wi system (Detector)

5.2.1.1. Operating AP



- 1) Connect the LAN cable to **ethernet** port (not internet) of AP, and the other to the LAN Card connector of workstation assigned for the data transfer.

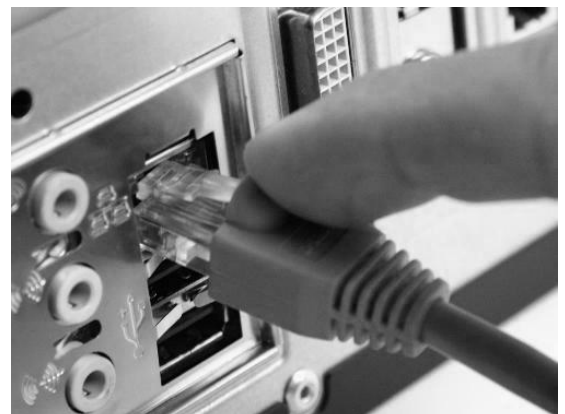

- 2) Connect the power cable to the **power** port of AP to supply power.



- 3) Turn on **Wireless On/Off** switch and push the **Power** button.



5.2.1.2. Functional Cable

This section describes how to connect the EVS 2430Wi system (Detector) without SSU by using functional cable.

	CAUTION	Installation of this equipment should be made by licensed and authorized personnel.
--	----------------	---

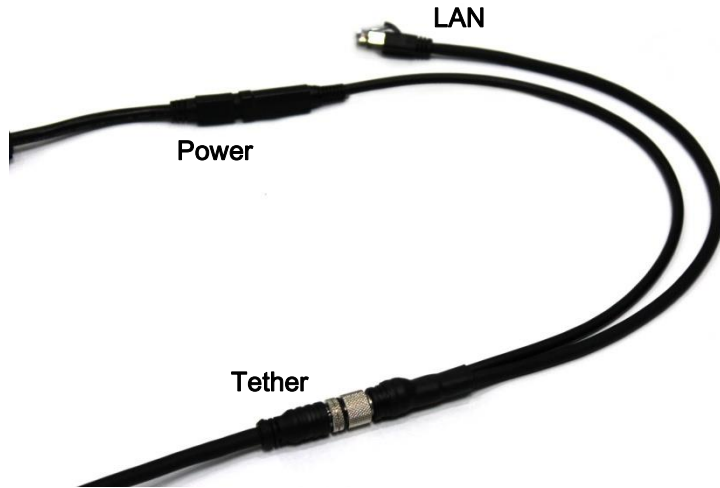

- 1) Connect the one of the functional cable to tether cable

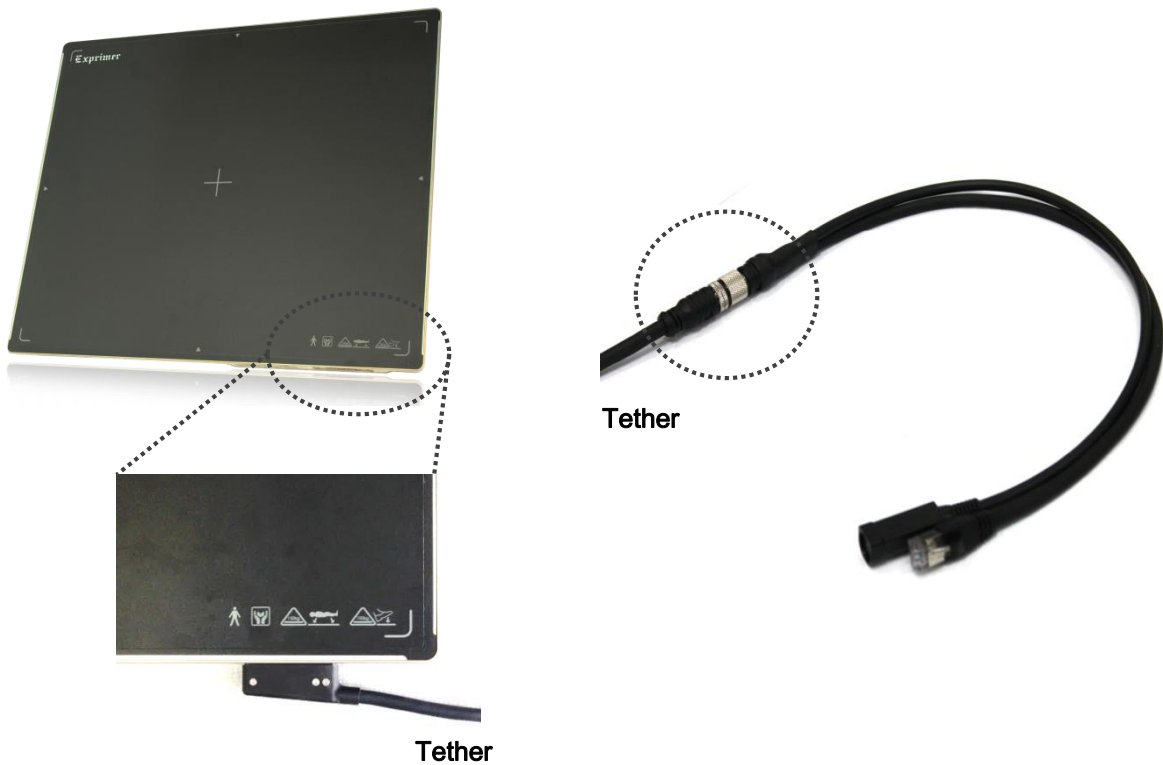

- 2) Connect the LAN cable to the LAN Card connector of workstation assigned for the data transfer

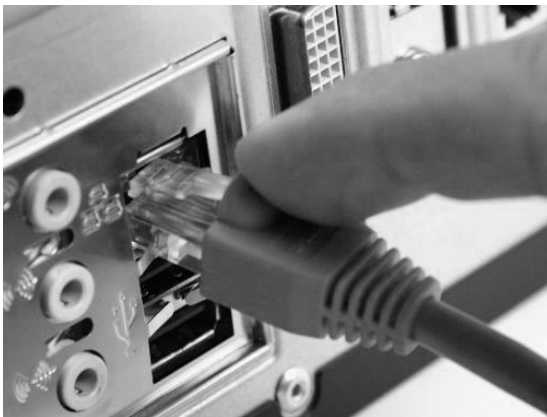

- 3) Connect the power cable to other side of functional cable to supply power

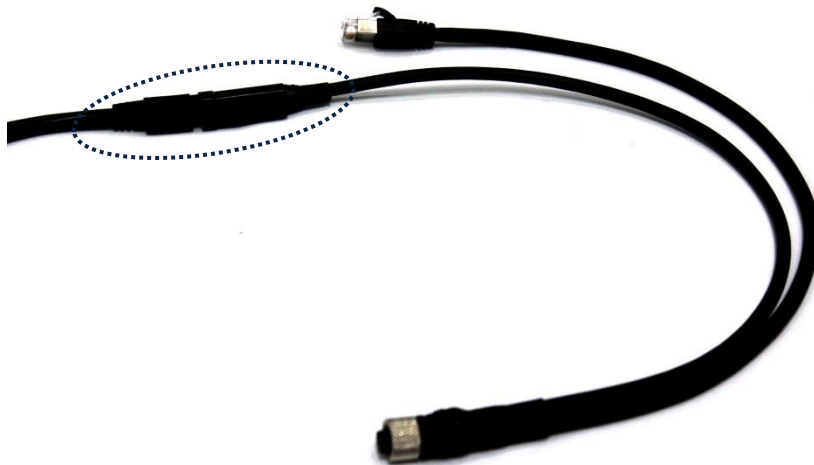

5.2.2. Operating Detector

1) Turn on the detector

- i** Before operating the detector, start up EConsole1

Press and hold the POWER button
(approx. 1 second)

Power lamp (Blue) lights up

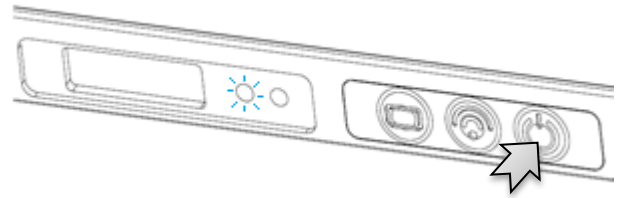

2) Register the detector and make connection to the EVS control system

i. Registration

AP lamp (Green) blinks

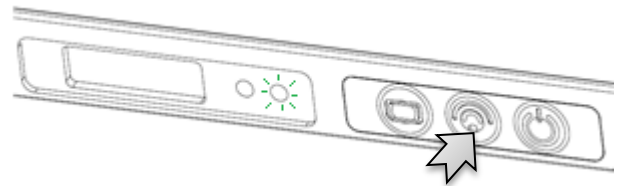

- i** When the AP lamp is blinking 1 time in 2seconds, system is in wired mode status.
- i** When the AP lamp is blinking 2 times in 2seconds, system is in wireless mode (AP_1) status.
- i** When the AP lamp is blinking 3 times in 2seconds, system is in wireless mode (AP_1) status.
- i** When the AP lamp is blinking 4 times in 2seconds, system is in wireless mode (detector AP) status.
- i** When the AP lamp is blinking 6 times in 2sec, system is in wireless mode (portable mode) status.

****User can set value of AP_1, AP_2, in Ecali Program. Please refer to Operation Manual for Ecali1 (Calibration tool).**

ii. Connection

Network connection between the internal wireless module of the detector and the wireless access point/EVS control system is secured automatically.
The link lamp lights up when the detector is registered and the communication connection is established.

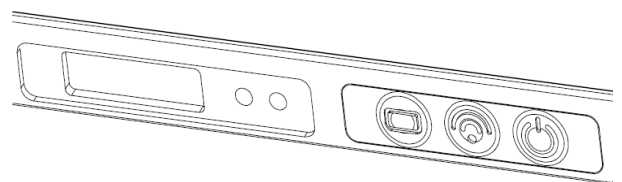

- i** The LINK lamp does not light up when the detector is not registered or the communication connection is not established.
- i** When the READY and AP lamp is blinking and LINK lamp does not light up, a communication error has occurred.
Please refer to troubleshooting.

3) Conducting Examination

For details about operation, refer to the **Operation Manual for the EConsole1**.

- i. **Select the patient information or protocols on the screen and start the examination.**



The READY lamp (green color) lights up after blinking 3 times when the detector and EConsole1 change to exposure ready status.

- Arrange the patient in the correct posture and position the detector aligning it with the target body part.
- Position the X-ray generator to adjust the exposure field.
- Check all conditions before exposure.

Make sure that two lamps (POWER and LINK) are lit and AP lamp is blinking. This means that the system is ready to start an examination.

- i** A communication error has occurred when LINK lamp lights are off.
- i** When the READY lamp (orange color) blinks slowly, the detector is in detector selection status (Sleep). The detector enters detector selection status automatically when it has not been used for a certain period of time.

ii. Press the exposure switch of the X-ray generator.

Images captured with the detector are transmitted to the ECali1 and appear on the monitor.

- Check the images on the monitor.
- If any uncompleted protocols remain, repeat procedure ii).

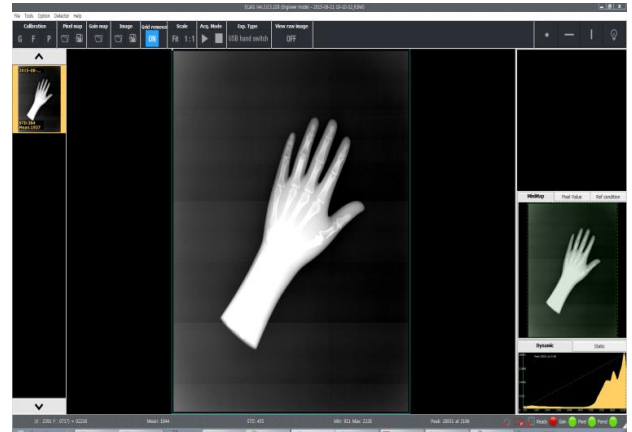



- Choose the exposure mode before the shooting.

Mode	Description
AED	Auto Trigger Mode.
USB hand switch	USB Switch Mode.

iii. Click the "Save Raw Image" button to store image.

- To conduct examination for another patient, repeat step iii).

	<p>IMPORTANT</p> <p>Sterilize the portion of the detector that has been in contact with a patient to prevent infection</p>
---	---

-  A signal strength indicator appears on the screen of the ECali1 computer. It shows the wireless communication level between the detector and ECali1.

Keep the wireless communication level stable on capturing or transmitting images.

Table 5.1. Signal Strength Indicator







Display	Signal Strength (communication stability)	Status	Required Actions
	Wireless, high (Stable)	Normal	
	Wireless, Normal (Stable)	Normal	
 	Wireless, Low (Unstable)	Unstable communication. Communication speed is lowered	Check whether there is any obstacle (e.q., your hands) between the wireless module and the wireless access point. If there is any obstacle, remove it. If the problem cannot be resolved, ask for consultation to your sales representative or local DRTECH dealer.
	No signal or No Link (Communication failed)	Disconnected communications	Confirms that detector and the access point are turned on. If the problem cannot be resolved, ask for consultation to your sales representative or local DRTECH dealer.
	Wired Link	Normal	External cable connected.

Table 5.2. Power Mode Indicator



















Display	Power Mode	Status	Required Actions
	Active		
	Sleep		Low power mode
	Deep sleep		Hibernation power mode only
	Power turned off or not linked	Disconnected communications	Power off

Table 5.3. Battery Remains Indicator

Display	Status	Ext. Pwr	Required Actions
	Charge complement	Ext. cable & battery	
	Ext. cable charging	Ext. cable & battery	
	100%	Only battery	
	90 to 99%	Only battery	
	80 to 89%	Only battery	
	70 to 79%	Only battery	
	60 to 69%	Only battery	
	50 to 59%	Only battery	
	40 to 49%	Only battery	
	30 to 39%	Only battery	
	20 to 29%	Only battery	
	10 to 19%	Only battery	Warning message is popped up at the bottom-right. Recommend to change the battery.
	0 to 9%	Only battery	Warning message is popped up at the bottom-right. Change the battery before the battery is discharged.
	No Battery or Error	Unkown	Change the battery. If the problem cannot be resolved, ask for consultation to your sales representative or local DRTECH dealer.

5.2.3. Image Data Retransmission

EVS 2430Wi can save the image data as file when detector is disconnected from AP during image data transmission. User can download the image file or receive the latest shot image data by using acquisition mode of EConsole1 after reconnection.

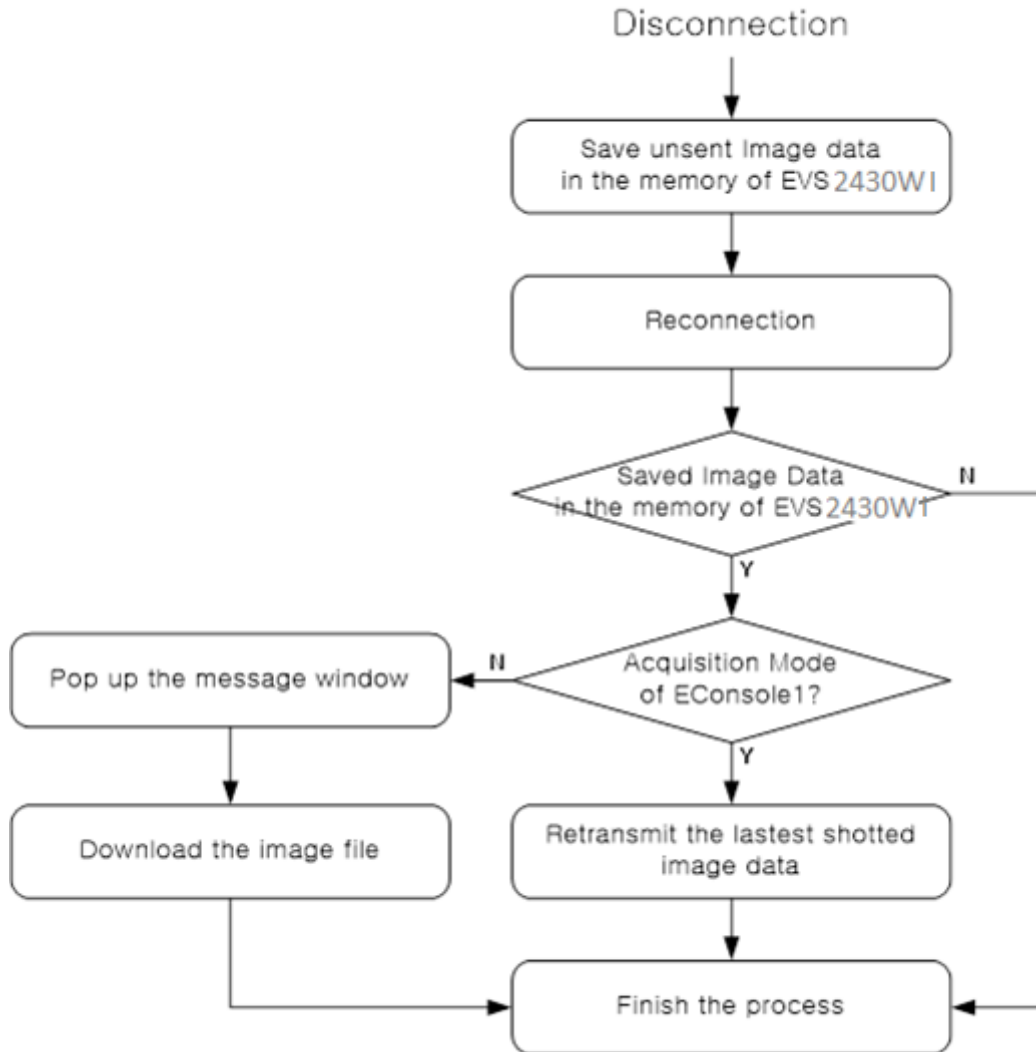

Figure 5.2. Flow Chart

If user does not use acquisition mode after reconnection, image data is saved as file. Image file cannot be retransmitted automatically even if acquisition mode is activated.

For details about operation, refer to the **Operation Manual for the EConsole1**.

5.3. Ending Use of the Detector

- **Turn off the detector**

Press the POWER button.

All the LED lamps should be off.

Table5.4. Detector Status List

Lamp type	Power Lamp	Ready Lamp		Link Lamp	AP Lamp
	■ Blue	■ Green	■ Orange	■ Green	■ Green
Power ON	○	X	X	X	X
During detector registration	○	X	X	X	X
Detector registration completed (1 Sec.)	○	X	X	○	★
Communication established	○	X	X	○	★
During exposure preparation	○	X	X	○	★
Ready status or performing an examination (Ready)	○	☆/○	X	○	★
During image data transmission	○	○	X	○	★
Sleep Mode	○	X	☆	○	★
Deep Sleep Mode	○	X	☆	○	★
Power OFF	X	X	X	X	X

○ : Light on

☆ : Blinking (On/Off status changes every second)

X : Lights off

★ : Blinking slowly (On/Off status changes every 2 seconds)

- : Unspecified status

5.4. Detector Initialization

- **Press the AP button for 20 to 25 seconds until AP LED lamp is blinking**
- **Detector will be connected again**
- **Setting the parameters of detector such as SSID, IP, etc.**

Refer to "7.2.1. Detector Configuration".

6. Extension Facility

6.1. X-ray Generator Interface

6.1.1. X-ray Exposure Mode

Table 6.1. Exposure Mode

Mode	Description
Auto Trigger Mode (AT)	<ol style="list-style-type: none"> 1. The detector detects actual amount of X-rays without any connection to the X-ray generator, and then performs image acquiring to the extent of image acquisition time and transmits the image data. 2. No signal used (No need of connector interface cable) <ul style="list-style-type: none"> • You can use AT mode without connecting the generator with USB SW Box or SSU physically.
Sync. Trigger Mode	<ol style="list-style-type: none"> 1. The detector receives EXP_REQ signal that X-ray generator is prepared to generate X-rays. 2. The detector prepares image acquiring and then responds EXP_OK signal to the X-ray generator. 3. The X-ray generator confirms EXP_OK signal and generates X-ray, then the detector performs image acquiring, according to image acquisition time and transmits the image data. <ul style="list-style-type: none"> • EXP_REQ (Generator→ Detector), EXP_OK (Detector →Generator)
USB SW Mode	<ol style="list-style-type: none"> 1. EXP_IN signal generates by USB SW Box then the detector receives Ready signal. And simultaneously, X-ray generator have ready status in 2. The detector prepares image acquiring 3. EXP_IN signal generates by USB SW Box and generates X-ray, then the detector performs image acquiring, according to image acquisition time and transmits the image data. <ul style="list-style-type: none"> • Ready_IN (USB SW Box -> PC -> Detector and X-ray Generator) • EXP_IN (USB SW Box -> PC -> Detector and X-ray Generator)

6.1.2. Auto Trigger(AT) Mode

AT Mode is available for acquiring images without any connection to X-ray generator. Generator interface cable is not required



Figure 6.1. AT Mode Configuration



- Make sure to follow operating environment requirements (Temp.:10 to 35 °C)
- If you use AT Mode out of operating environmental requirements, unwanted image can be acquired without x-ray image acquiring process.
- Do not hit or drop the equipment. Unwanted images can be acquired in the AT Mode if it receives a strong jolt.
- If you image a thick object in the AT Mode with low X-ray tube voltage, an image may not be acquired.
- AT performance is proportional to KV energy. Therefore, it is recommended to increase KV as much as possible and relatively decrease mA and ms.
- When you set x-ray exposure area towards the direction of the detector, the center block of the detector should be included in the X-ray exposure area. Otherwise, you may not acquire an image.
- The minimum X-ray exposure area should be wider than 4cm X 8cm on the center block of detector.

6.1.2.1. Recommendation of setting AT Sensing Area

6.1.2.1.1. Stand Environment

We suggest the collimated area on detector is wider than 4cm X 8cm, and keep along the vertical direction as shown in figure 6.2.

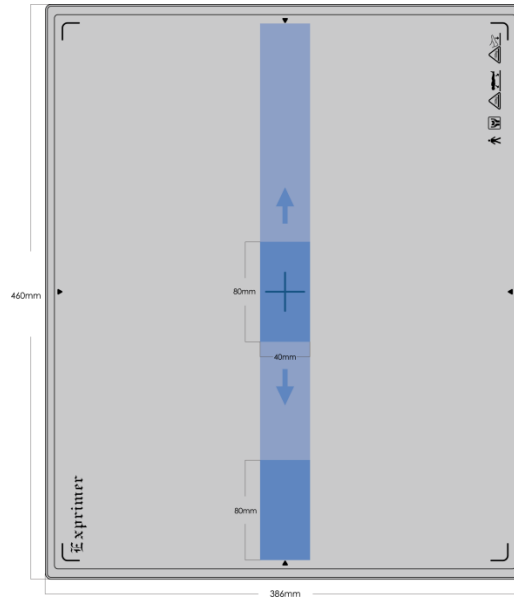

Figure 6.2 Stand Environment with AT Mode

6.1.2.1.2. Table Environment

We suggest the collimated area on detector is wider than 4cm X 8cm, and keep along the horizontal direction as shown in figure 6.3

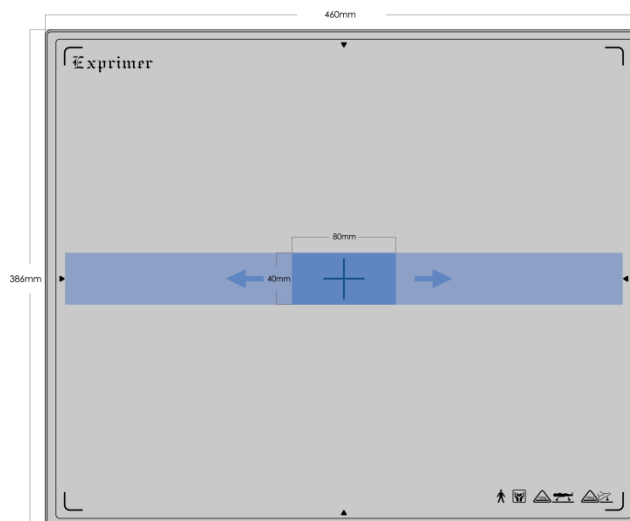

Figure 6.3. Stand Environment with AT Mode

6.1.3. USB SW Mode

USB SW Mode is the most common and recommended exposure mode at a retrofit scope. User can achieve high quality images with USB SW Mode.

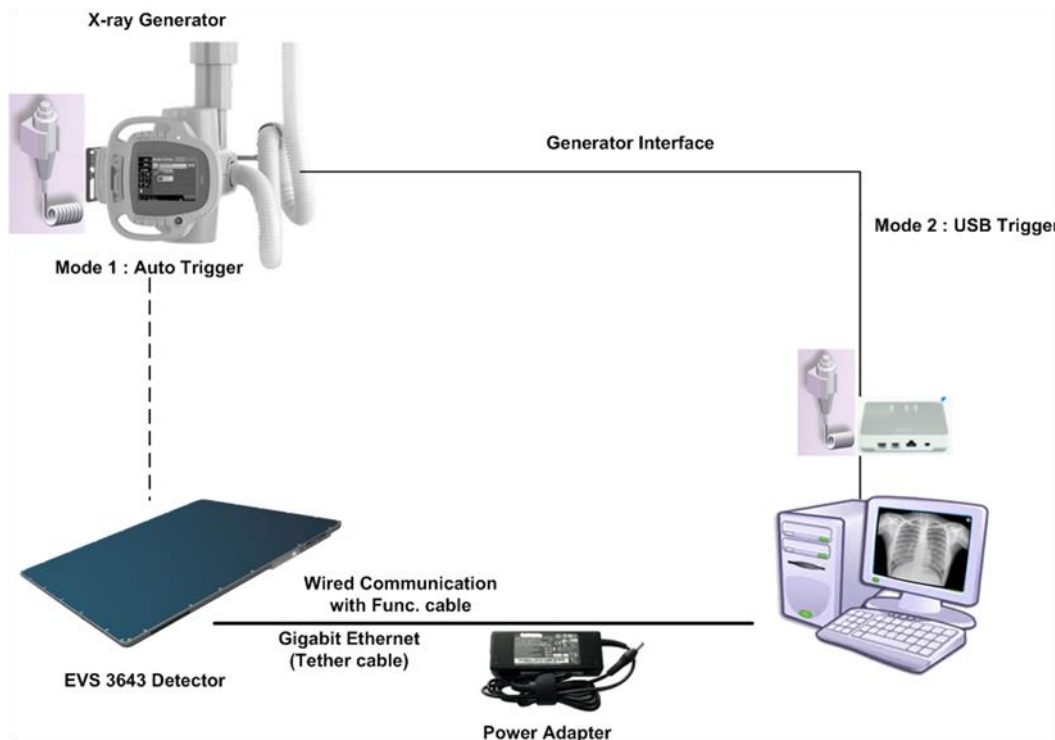

Figure 6.12. EVS 2430Wi USB Sw Mode Configuration



- The USB interface mode is a wired connection of wireless detector with SSU.
- PC and detector are connected by tether interface cable. (consistent power supplying by adoptor).
- It is used in case when faster image transmission is needed, compared to a wireless connection.
- A wireless module in the detector is deactivated. (The equipped battery is not consumed)
- Connect the generator with USB SW Box physically to make an exposure in USB SW mode.
- You can use AT mode without connecting the generator with USB SW Box physically.
- Multiple detectors can be configured with one USB Box.

6.1.3.1. Wiring USB SW Mode

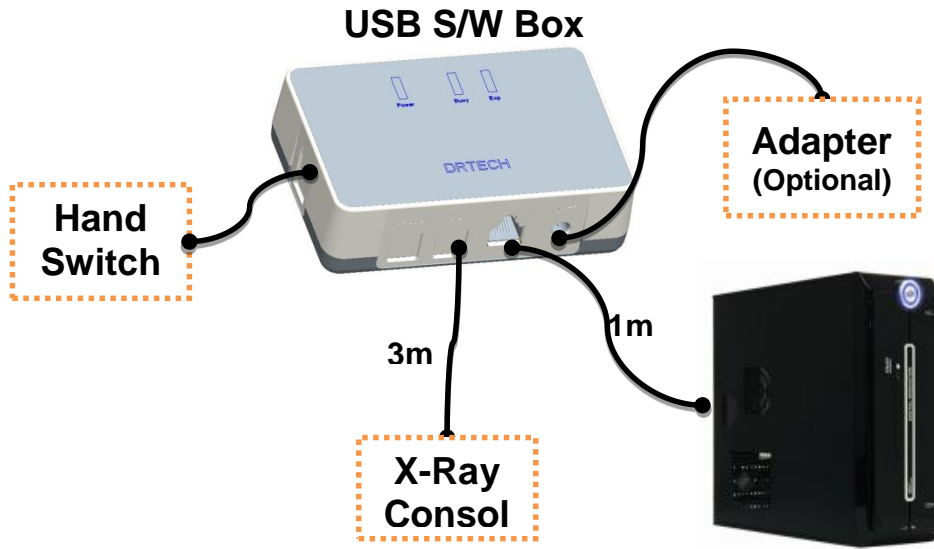

Figure 6.13. Wiring USB Switch box

6.1.3.2. Connector Description

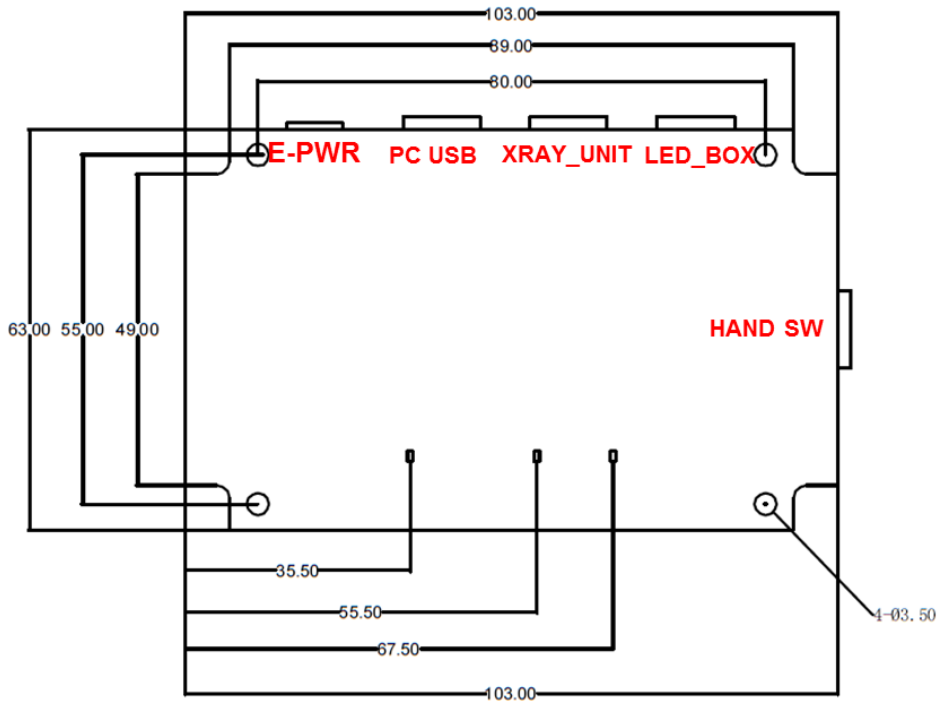

Figure 6.14. USB Switch box Connector

6.1.3.3. Connector Pin Assignment

Num.	Connector Name	Remark
1	PC USB	RJ45-8Pin
2	XRAY_UNIT	RJ11-4Pin
3	LED_BOX	RJ11-6Pin
4	HAND SWITCH	RJ11-4Pin
5	E-PWR	(Adapter CON) DC5V/2A

6.1.3.4. X-ray_UNIT

Pin Num.	Pin Name	Remark
1	XRAY_RDY_COM	* Dip SW Option
2	XRAY_EXP_GEN	
3	XRAY_RDY_GEN	
4	XRAY_EXP_COM	* Dip SW Option

* XRAY_RDY_COM and XRAY_EXP_COM can be connected using dip switch.
It depends on x-ray generator.

6.1.3.5. Hand Switch

Pin Num.	Pin Name	Remark
1	HAND_SW_RDY_COM	GND
2	HAND_SW_RDY	
3	HAND_SW_EXP	
4	HAND_SW_EXP_COM	GND

6.1.3.6. PC USB

Pin Num.	Pin Name	Remark
1	VCC (+5V)	-
2	RDY_IN	-
3	LED_SW_CONTROL	-
4	EXP_IN	-
5	EXP_OUT	-
6	GND	-
7	-	Not Connected
8	-	Not Connected

6.2. Software Installation

This section gives information about how to install the software on the workstation (PC) and how to configure the environment for software operation and communication.

6.2.1. Software Classification

DRTECH provides clients who purchase our detector system with software as shown below. User can choose and use one of the software below.

Software	Description
Econsole1	Image acquisition and adjustment software developed by DRTECH. There is no need to develop separate software.
Ecali1	A configuration and management software for the detector
Document	Econsole1 Operation Manual
EVS SDK	Software development kit for EVS 2430Wi detector only, provided by DRTECH You can develop your own software dedicated to EVS 2430Wi by using this kit.
Document	EVS 2430Wi SDK Developer's Manual

6.2.2. Software Installation

- For a client who uses Econsole1, Install Econsole1 program after reading Econsole1 Operation Manual carefully.
- For a client who uses EVS SDK, Install the Setup program after reading EVS SDK Developer's Manual

	<p>CAUTION</p> <p>Be sure to install the software first with perusing the manual, before configuring Windows environment.</p>
--	---

6.3. Windows Environment Setting

This section gives information about configuring Windows to communicate with the detector.



The contents in this chapter are made on the basis of Windows 7.

Configuration environment can be different depending on network adaptor manufacturers or models.

6.3.1. Network Communication



CAUTION

Communication disruption between the detector (Or SSU) and workstation occurs unless the network adaptor is set properly. It may cause serious repercussion to the product and image quality.

➤ Network Adaptor Selection

- 1) Click **Start** → **Control Panel** → **Network and Internet** → **Network and Sharing Center** → **Change Adapter Setting**.
- 2) Choose the networks adaptor for communicating with the detector and SSU, and then rename it.
- 3) Click the chosen network adaptor with the right mouse button and click Properties to display the Properties window.

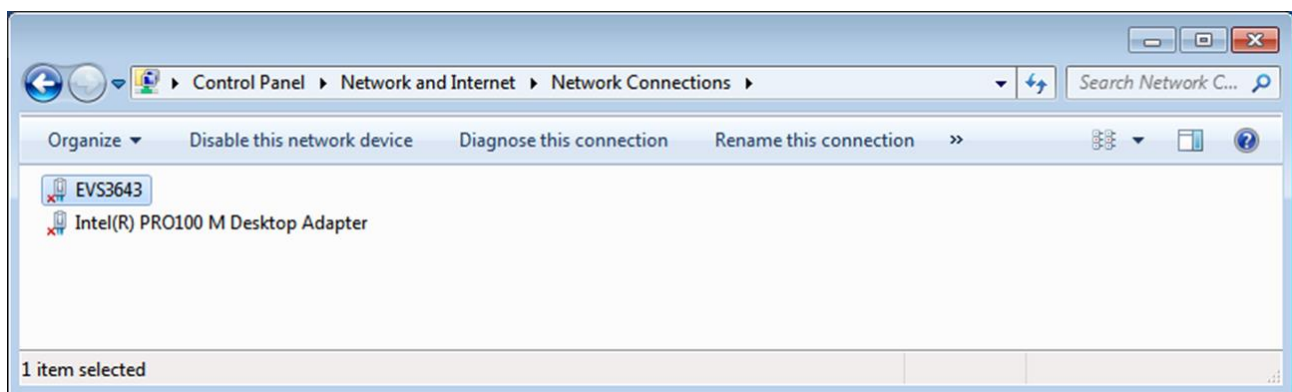

➤ **Network Adaptor Configuration**

- 1) Click **Configure** button to open the following dialog box, and then go to the **Advanced** tab.
- 2) Choose **Flow Control** in the list of **Properties** and click **Value** button on the right.

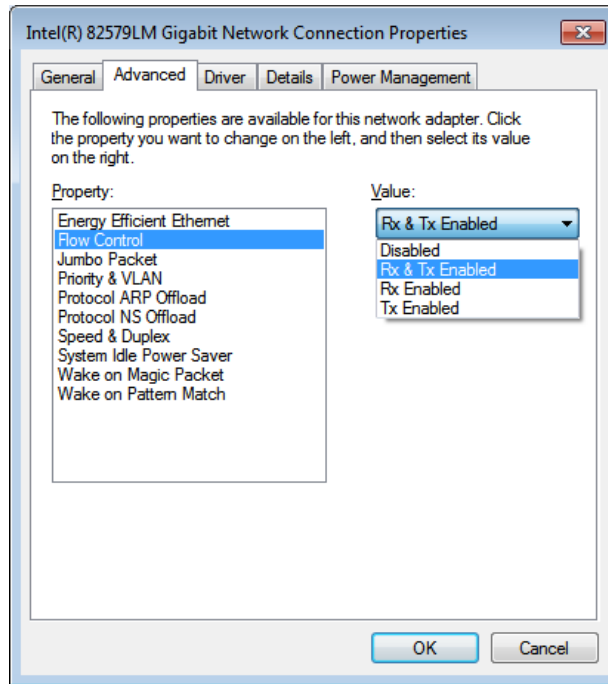

3) Power-saving Mode on Network adaptor

- Click the **Power Management** tab and check on **Allow the computer to turn off this device to save power**.
- Click **OK** button

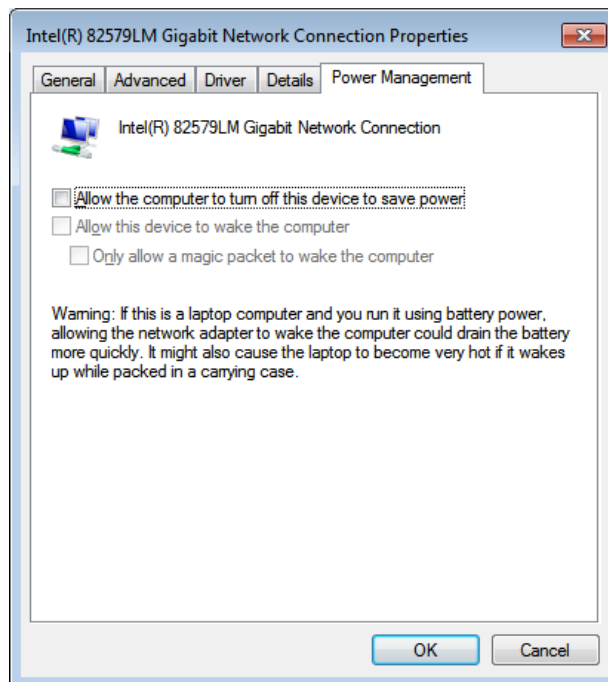

4) Protocol selection and IP address setting

- Click Properties button after selecting **Internet Protocol Version 4 (TCP/IPv4)**.
- Input the IP address and subnet mask as shown below, and then click **OK** button.

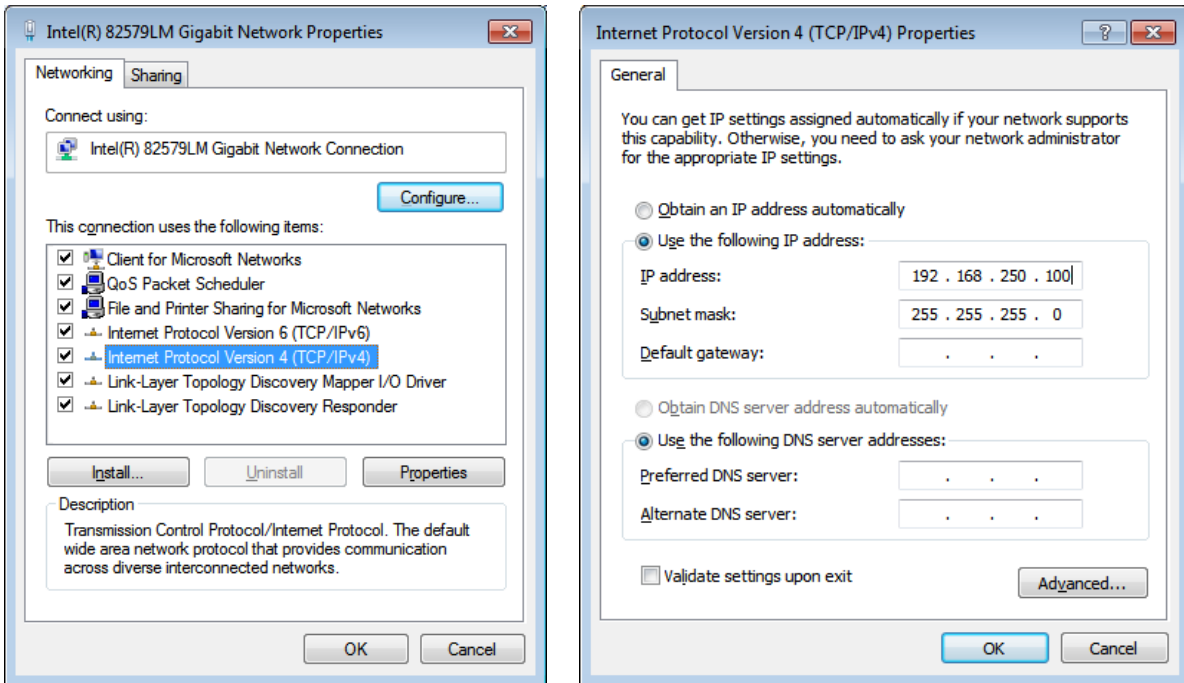

- It is recommended to set IP address and Subnet mask in the presented range of this document.
- If you use IP address and Subnet mask out of the presented range, it would be difficult to identify the cause or resolve in case of communication disorder.

6.3.2. Disabling Sleep Mode on Monitor

- 1) Click **Start** → **Control Panel** → **Power Options** and then move to the **Choose when to turn off the display** tab.
- 2) Set **Put the computer to sleep** to **Never** to disable the sleep mode.
- 3) Click **Save changes** button.

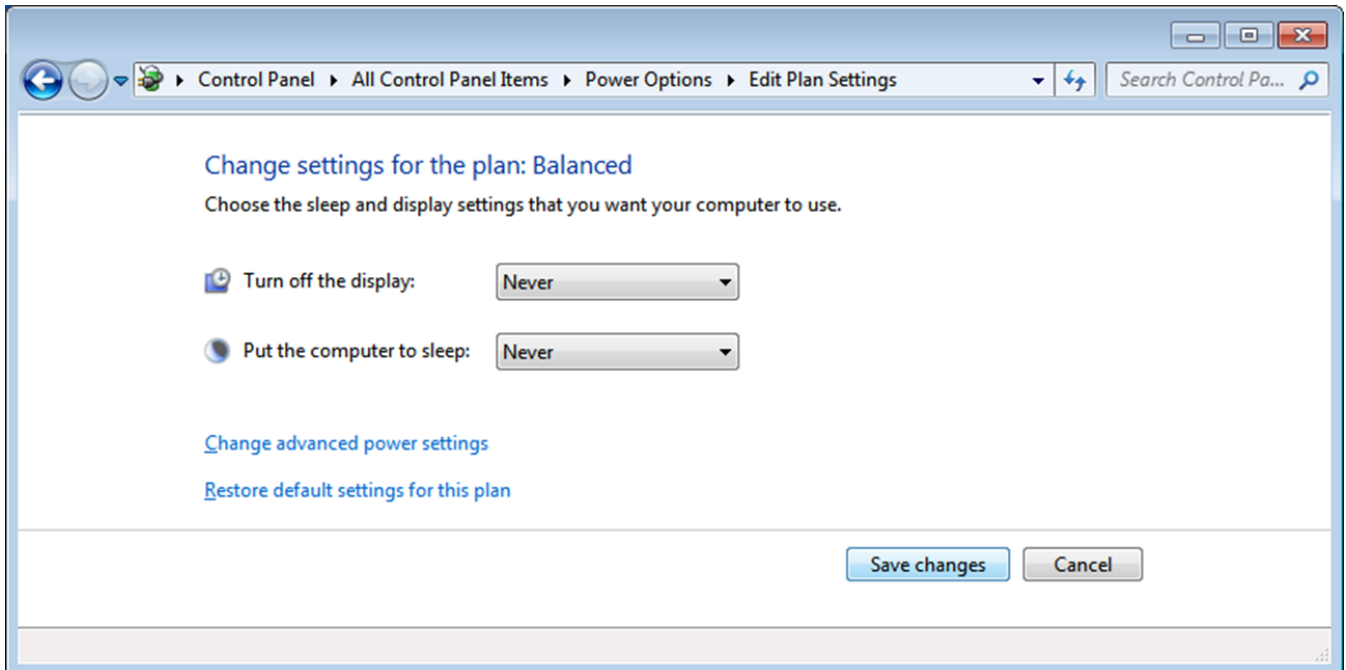

7. Device Setting

7.1. AP Setting

7.1.1. AP Configuration

Normally, AP setting does not need to be changed by user, because AP is set to match the use environment when the product is inspected for shipping.

- 1) Check IP address of AP
 - Enter the IP address of AP, as set in ECal1 (192.168.250.98).
 - Choose **Network tab** → **LAN**. IP address can be seen as stored.

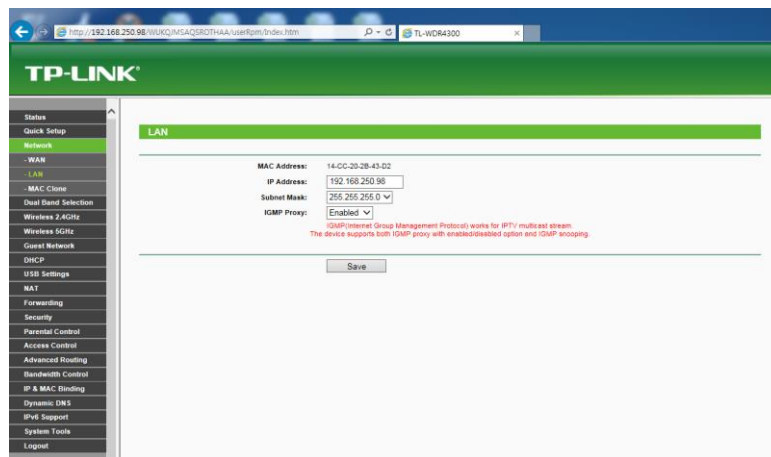

- 2) Setting wireless communication

- Choose **Wireless 5GHz or 2.4GHz** → **Wireless Setting**.
- Register wireless Network Name same with the detector, and select Region, Channel Width, Channel depending on the use environment.

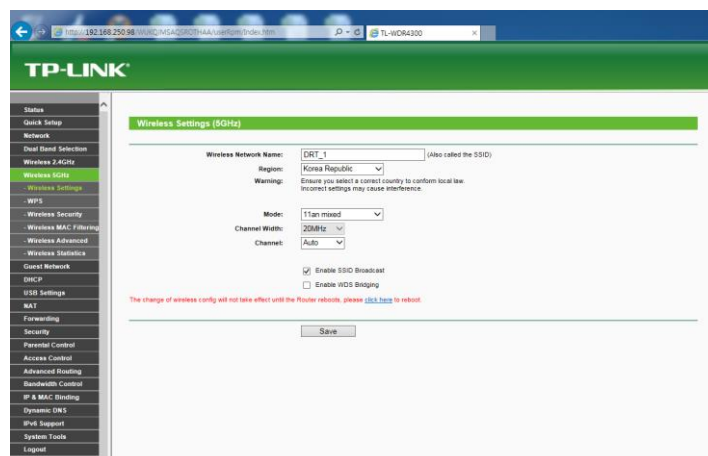

3) Setting wireless communication

- Choose **Wireless 5GHz or 2.4GHz** → **Wireless Security**
- Choose **Disable Security** and click the **Save** button
- Detector can not be connected to AP if security is enabled.

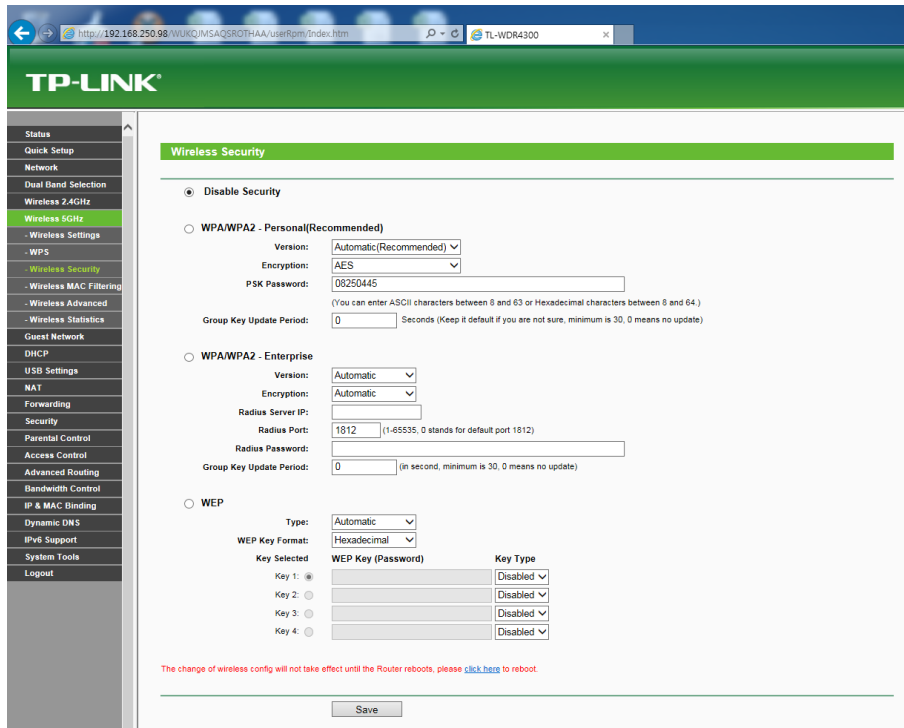

- Default IP Address of Detector is 192.168.250.135.
- 13 numbers of channel can be used in 2.4GHz Frequency.
- 8 numbers of channel can be used in 5GHz Frequency.
- Available channel will be limited according to country and region.
- Channel Bonding is for enhancing transmission speed. However, transmission speed may be decreased due to channel's interference, even if channel bonding has been done.
- Channel's (+/-) will be activated in case of using 40MHz Frequency bandwidth.
- The configuration whether bonding with above channel or below channel can be done.
- AP's SSID should be same as Detector's SSID, if user intends to use wireless communication.

7.2. Detecting Setting

7.2.1. Detector Configuration

For details about each parameter, refer to the **Operation Manual for ECali1**

Start up ECali1. Click **Option** → **Configuration** → **Detector** Tab.

Menu	Description
Path to save map files	Register each map file that corresponds to the product
Pre-processing	Value for pre-processing. Do not change it by yourself.
Serial number	Register the serial number of product.
Router IP	IP address of AP. The detector can not be connected to AP if router IP is changed.
Grid selection	Select type of the grid and register the path of grid filter.
Exposure mode	Choose exposure mode
Wired/Wireless	Choose communication mode
Image mode	Select image mode
Power management	Waiting time for sleep mode can be adjusted by setting parameters below. 1) Acquisition sleep time Mode is changed from acquisition mode to sleep mode, after the set waiting time. 2) Deep sleep time Mode is changed from sleep mode to deep sleep mode, after the set waiting time.
Hardware setting	AP button on detector is activated if Enable AP Button is checked.

➤ Image TimeOut

Set the time limit to prevent re-transmission request.

Item	Description
Time	The set waiting time for image to be transmitted.

After starting image transmission, the detector ignores received information of image transmission request, if the following conditions are all met.

- Image is being transmitted :
No interference is allowed during transmission.
- Transmission process is not completed :
After transmission, there is a slight waiting time for the transmission process to be finished.

➤ Deep Sleep Mode

Normal	Detector can be operated and take an exposure at any time.
Sleep	Detector can be operated and take an exposure at any time within 2 seconds.
Deep Sleep	Detector can not be operated. User can take an exposure only if Deep Sleep Mode is canceled.
Power Off	Detector has been turned off. User can take an exposure after detector is rebooted.

- You can prevent unnecessary battery consumption by using the Deep Sleep function.
- When SSU power is supplied to the detector by connecting a tether interface cable, the Deep Sleep function cannot be operated.
- When using the Deep Sleep function, be sure to check if the detector is in Deep Sleep mode before making an exposure. You cannot acquire images when the detector is in Deep Sleep mode.
- When the Deep Sleep mode is disabled, the detector needs maximum of 10seconds to wake up. It may not be available to acquire images during this time.

7.2.2. Detector Power Save Management

➤ Meaning

Normal	Detector can be operated and take an exposure at any time.
Sleep	Detector can be operated and take an exposure at any time within 2 seconds.
Deep Sleep	Detector can not be operated. User can take an exposure only if Deep Sleep Mode is canceled.
Power Off	Detector has been turned off. User can take an exposure after detector is rebooted.

➤ Entry Condition for Power Save Mode

Mode	Description
Normal	-
Sleep	Activates when the detector has not been used for a certain time.
Deep Sleep	Time can be set to automatically go into Deep Sleep mode, after a certain period of time passed under sleep mode.
Power Off	Detector is turned off if detector has not been used for a set period of time (Power off) from the entry time of Deep Sleep Mode. However, in case of not using Deep Sleep mode function, Detector is turned off if detector has not been used for certain time (Power Off After).

➤ Disabling Power Save Function

Mode	Description
Normal	-
Sleep	Detector is in sleep mode.
Deep Sleep	Turn off Sleep Mode After setting time. Call the function for turning off Deep Sleep Mode at SDK.
Power Off	Reboot the detector with pressing power button on the detector.

➤ Other Information

Mode	Initial Value	Turnaround Time
Normal	-	
Sleep	-	Approx. 2 sec.
Deep Sleep	OFF /10 min	Approx. 10 sec.
Power Off	OFF /60 min	Approx. 40 sec.

**CAUTION**

- When using the Sleep function, be sure to check if the detector is in Sleep mode before making an exposure. You cannot acquire images when the detector is in Sleep mode.
- When the Sleep mode is disabled, the detector needs max. 1 to 2 seconds to wake up. It may not be available to acquire images during this time.

8. Troubleshooting

8.1. Failed to Turn the Detector On

➤ Symptom

- Failed to turn on the power of the detector.

➤ Possible Causes

- Not installing battery pack well
- Dead battery pack
- Battery pack or Detector is broken

➤ Solutions

- 1) Install the battery pack.
- 2) Charge the battery pack.
- 3) Check the result after getting rid of the battery pack and connecting the tether interface cable.
- 4) Replace other battery packs and check the results.
- 5) Replace other Detectors and check the results.
- 6) Replace corresponding devices.

8.2. Errors in Detector LED

➤ Symptom

- Ready LED (Orange) lamps of detector are blinking 3 times/sec.

➤ Possible Cause

- Internal hardware errors of the detector

➤ Solutions

- 1) Consult with service engineers of DRTECH

8.3. The LINK LED does Not Turn on

➤ **Symptom**

- The LINK LED does not turn on when power LED is ON

➤ **Possible Cause**

- Detector registration error

➤ **Solutions**

- 1) Check if AP is turned on.
- 2) Check if network cable is plugged to ethernet port of AP.
- 3) Check the network cable connection between workstation and AP.
- 4) Check the windows and network environment again such as firewall and IP address setting.
- 5) Check if the SSID of Detector is same as SSID of AP by using tether interface cable.

8.4. Rapid Consumption of Battery

➤ **Symptom**

- Consumption of a fully charged battery pack is fast.

➤ **Possible Causes**

- Performance decrease caused by usage of long time.
- Usage of battery pack in low temperature environment

➤ **Solutions**

- 1) Replace to new battery pack if the battery pack has been used for a long time. (Battery pack is a consumable)
- 2) Use battery pack in normal room temperature environment. Charging capacity of battery pack in low temperature environment will decrease the capacity.

8.5. Battery Pack or Installation Part of Battery is Getting Hot

➤ Symptom

- Battery pack or compartment for installation of battery pack is getting hot.

➤ Possible Causes

- Battery pack failure
- Detector Failure

➤ Solutions

- 1) Do not use the battery pack
- 2) Consult with service engineers of DRTECH

8.6. The Power Switch of SSU or Status LED is not working

➤ Symptom

- The power switch of SSU is not working.
- The status LED of SSU is not responding.

➤ Possible Causes

- Power cable is broken down.
- Errors in the fuse
- Internal circuit is broken down.

➤ Solutions

- 1) Check the connection between AC power cable and SSU.
- 2) Replace the fuse.

9. Maintenance and Inspection

In order to ensure that the equipment is used safely and normally, be sure to inspect the equipment before use. If any problem is found during the inspection and cannot be corrected, please contact your sales representative or local DRTECH dealer.

➤ Daily Inspection



WARNING

For safety reasons, be sure to turn OFF the power to each piece of equipment before the following procedures. Otherwise, an electric shock may result.

✓ Cable

- 1) Ensure that cables are not damaged and cable jackets are not torn.
- 2) Ensure that the power cord plugs are securely connected to both the equipment AC inlet and the AC outlet.

✓ Detector

- 1) Ensure that there are no loose screws or broken parts.
- 2) Ensure that there is no dust or foreign substance on the external connector.
- 3) Ensure that there are no broken parts or short-circuits in the power supply connector.

✓ After turning on the power

Be sure to start ECal1 before performing the following inspection.

- 1) Perform test exposure.

➤ Monthly Inspection

- 1) Ensure that there are no loose screws or broken parts.
- 2) Ensure that there is no dust or foreign substance on the external connector.

➤ Yearly Inspection

- 1) Perform a Performance Test or Self-diagnosis using a phantom or resolution chart, etc.

➤ Irregular Inspection

✓ Calibration

- 1) Perform Calibration when exposure conditions have changed significantly.
For details, refer to the Setup Guide for ECal1.

10. Specification

10.1. Main Specifications

10.1.1. EVS 2430Wi / EVS 2430GWi X-ray Detector

[Dimensional Diagram]

(Unit mm)

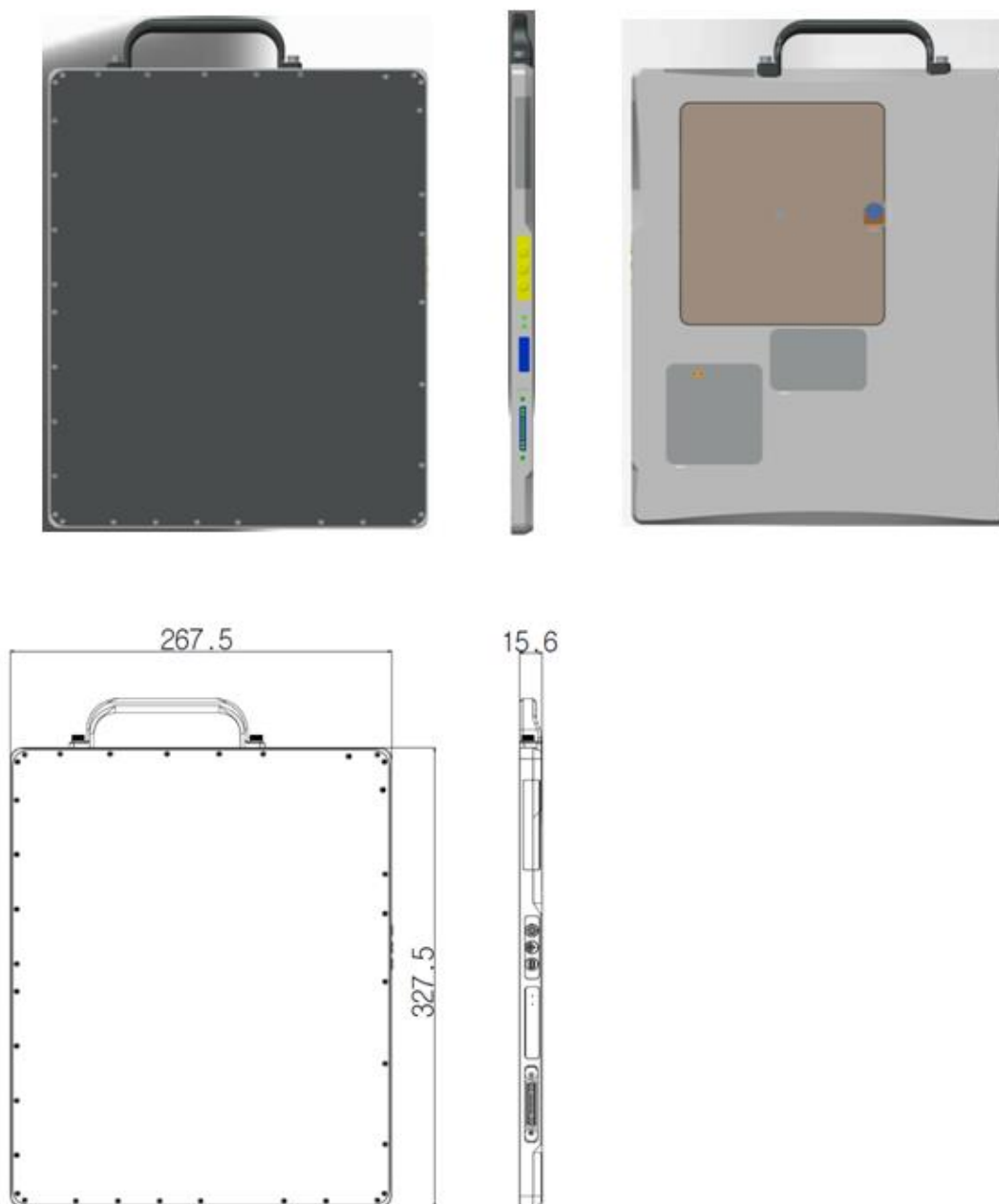

Figure 10.1 Detector Dimension

10.1.2. Battery Charger System

[Dimensional Diagram]

(Unit mm)

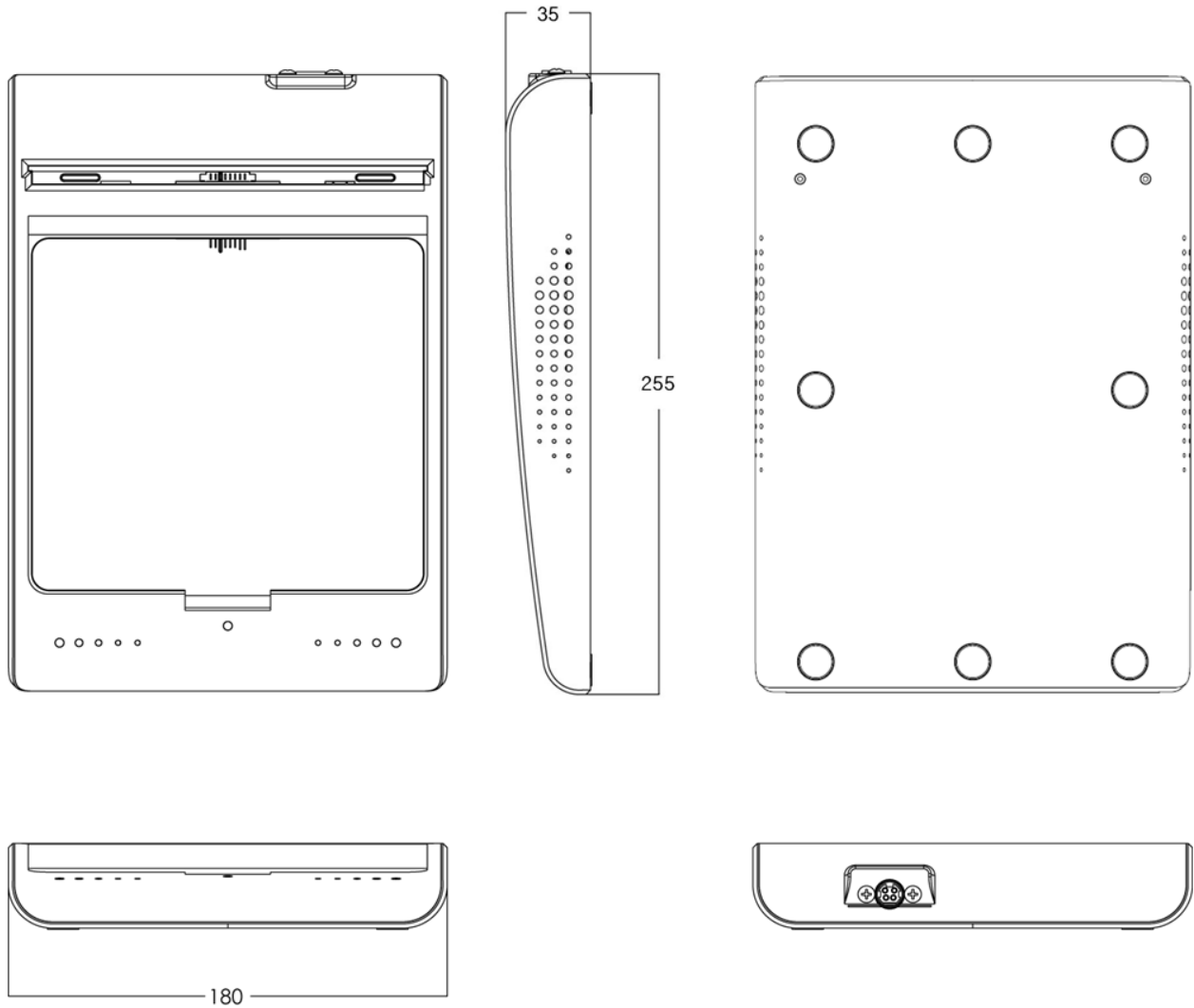

Figure 10.2 Battery Charger System Demension

10.1.3. Battery Pack

[Dimensional Diagram]

(Unit mm)

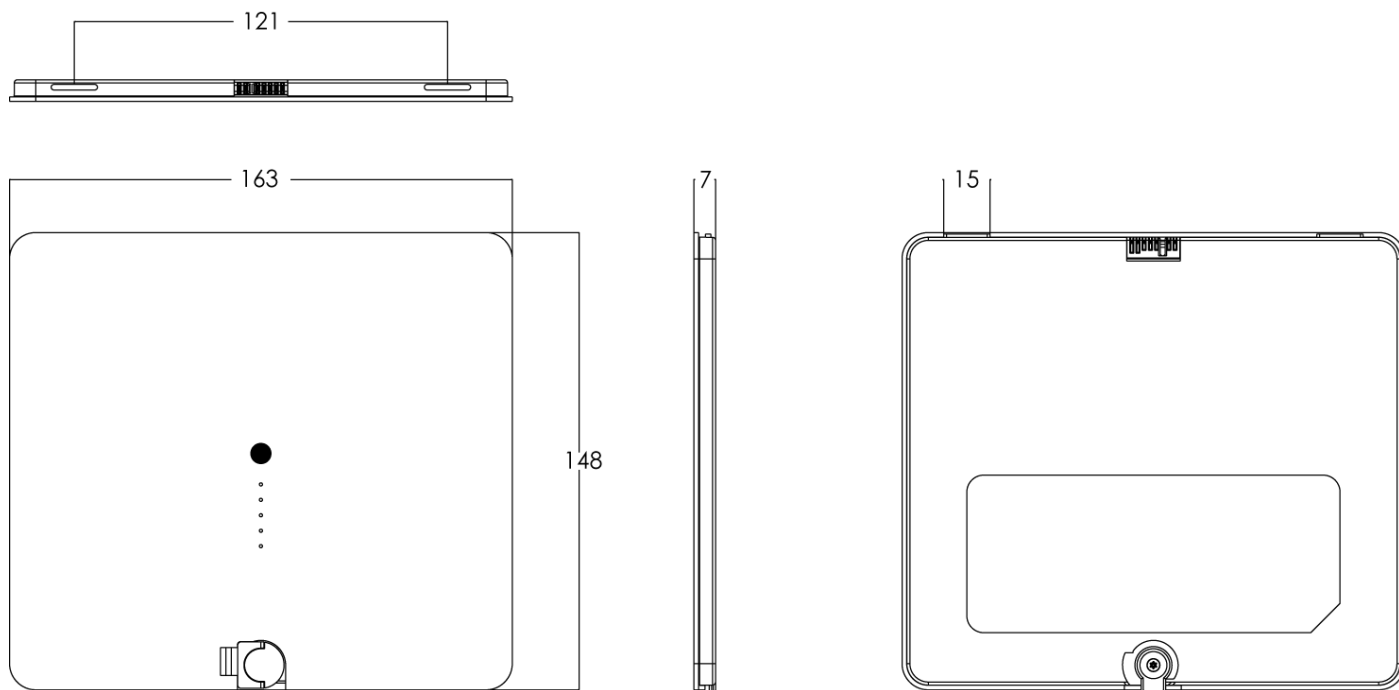

Figure 10.3 Battery Pack Demension

10.1.4. EVS-WPCS

[Dimensional Diagram]

(Unit mm)

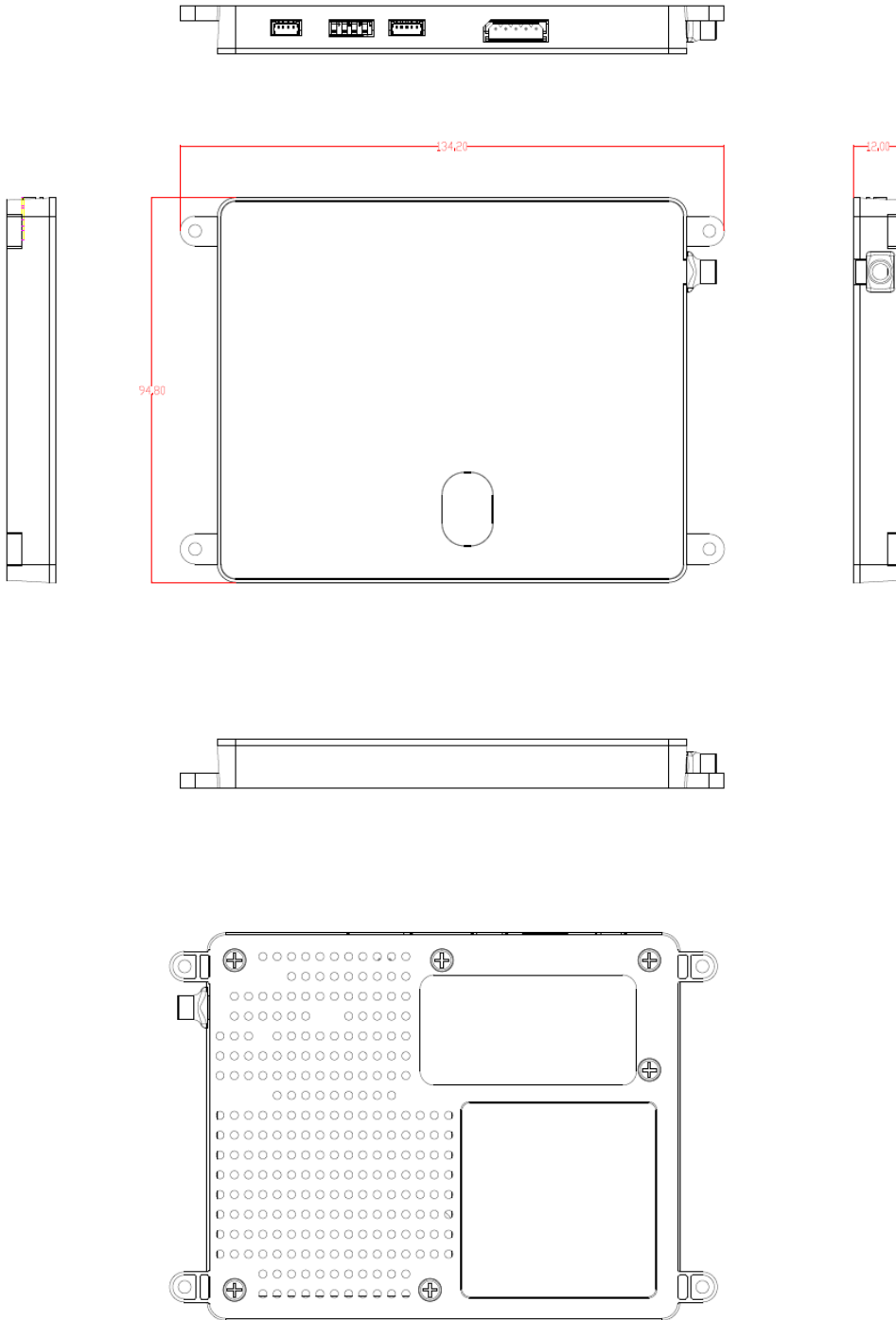

Figure 10.4 EVS-WPCS Demension

10.2. Characteristics

➤ Typical Patient Doses

- Typical patient doses are equivalent to 500-1000 speed film/screen systems.

➤ Sensitometric Characteristics and Dynamic Range

- EVS 2430Wi Wireless responds linearly against the exposure range for 500-1000 speed film/screen where it can depict the clinical information. It means that EVS 2430Wi fully covers a dynamic range of 0.2-20 μGy at least.

➤ Spatial Resolution Properties

- EVS 2430Wi
A typical MTF value at 2 lp/mm, than 40%.
- EVS 2430GWI
A typical MTF value at 2 lp/mm, than 25%.

➤ DQE

- EVS 2430Wi
A typical DQE value at 1 lp/mm is 55%.
- EVS 2430GWI
A typical DQE value at 1 lp/mm, than 50%.

The product safety standards that apply to the EVS 2430Wi, which includes the following equipments, are as below.

- Detector
- Battery Charger
- Battery Pack
- WPCS Module
- Wiring unit (sold separately, optional unit)

10.3. Packing

Note

Figures and Illustrations in this Technical Manual are provided for reference only and may differ from the actual product appearance.

10.3.1. Product Configuration List

Table 10.1. EVS 2430Wi (Wireless) Supply Part List

No.	Product Name	Q'ty	Remarks
1	TFT Detector Plate	1	
2	Battery Charger	1	
3	Battery Pack	2	
4	Power Adaptor	1	
5	AC Power Cable	1	
6	Tether Cable		
7	Functional Cable		
8	LAN Cable	1	
9	LAN Card	1	
10	Access Point	1	
11	Software CD	1	

Table 10.2. Optional Product List

No.	Product Name	Q'ty	Remarks
1	System Synchronization Unit (SSU)		
2	AC Power Cable		
3	Generator Interface Cable set		
4	Adaptor Cable		
5	USB Switch Box Set		
6	Protection Case		
7	Grid for Protection Case		
8	Surface Pro 3		
9	DROC S/W		
10	Workstation		

Note

If you find any items missing from the list above upon unpacking, please contact your dealer.

10.3.2. Assemble Package

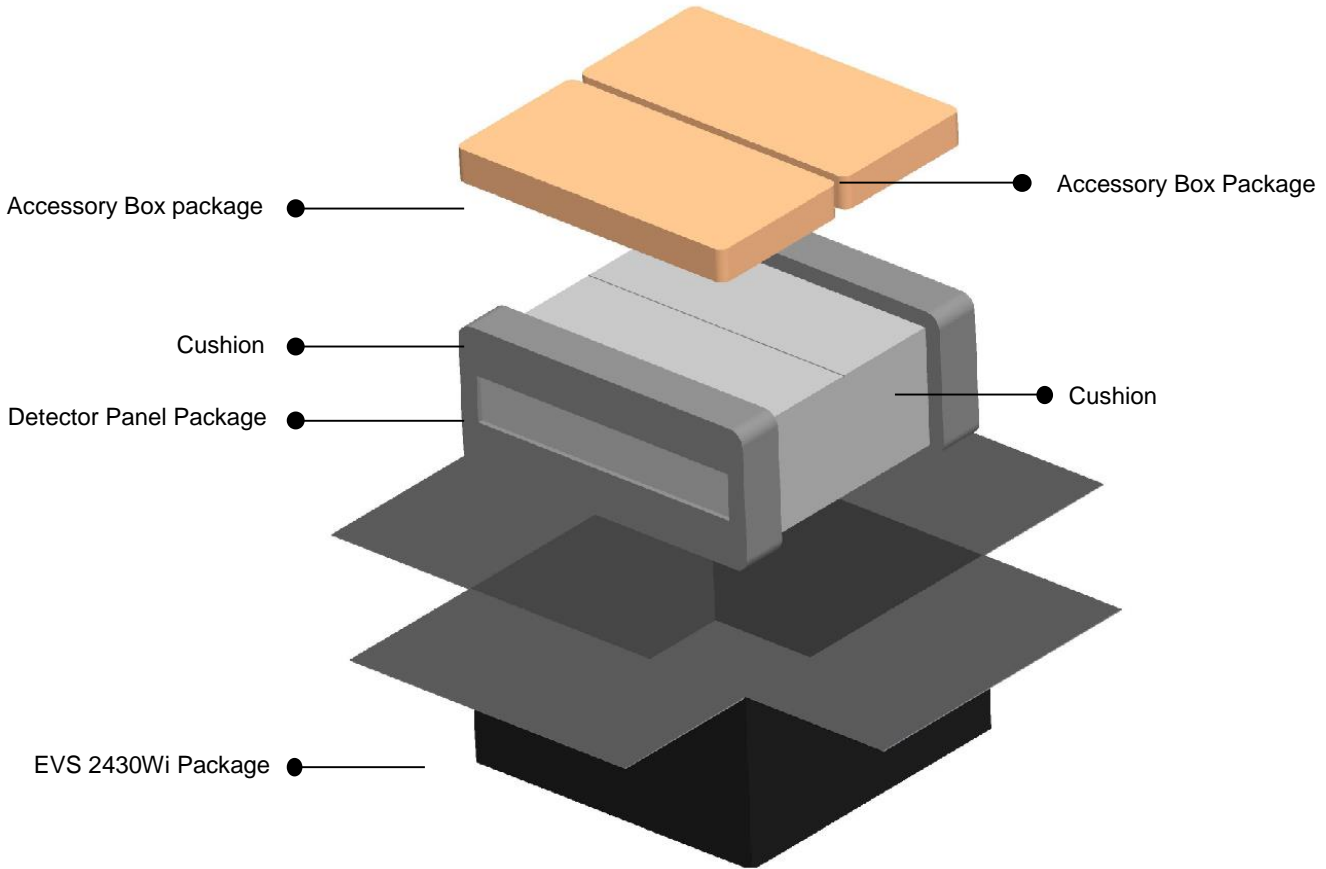

Warning

Operational issues may occur if inappropriate force is applied to the product during unboxing. Please handle the box containing the product with care.

Note

The packaging that came with the product should not be damaged or discarded as it is needed for after-sales service or for exchanging the product with a new product. If the packaging or any component is missing, the damaged product cannot be refunded or exchanged with a new product.

10.3.3. Detector Panel Package

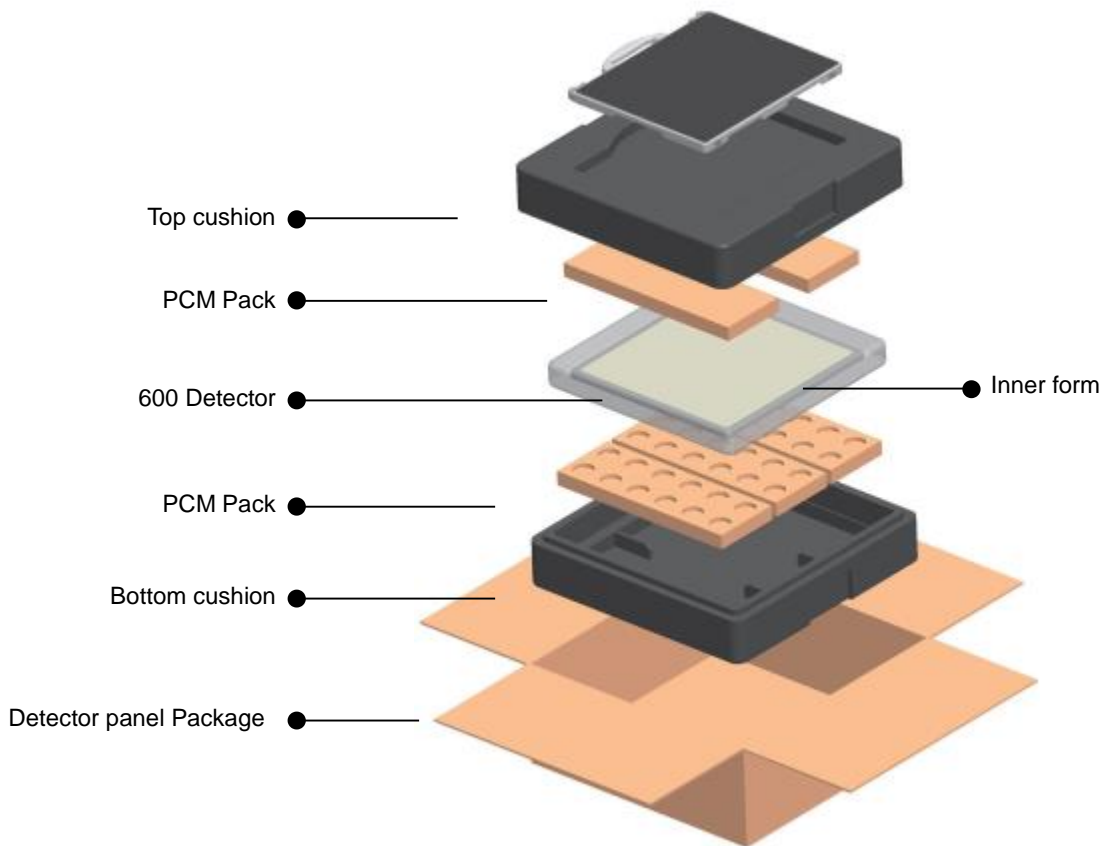

Note

- The PCM pack can explode from a hard impact or a contact with a sharp object.
- It is non-toxic and may not cause serious harm. However, please take extra precaution as it is a chemical substance, and remember to carefully follow the instructions.
- If the inner chemicals get on your body, immediately wash it off thoroughly with clean water.
- If the inner chemicals get in your eyes, wash your eyes with tap water for more than 15 minutes and consult your doctor.
- If the contents are accidentally ingested, drink two glasses of water (500ml) and consult your doctor.
- How to discard the content: Please discard used PCM packs using one of the following methods.
- Collect a certain number of packs and send them to the manufacturer.
- Treat them in a nearby chemical waste processing facility.

Note

- PCM Pack [Phase Change Material Pack]
- The PCM pack placed in the Bottom cushion is intended to maintain mild temperature over a certain period of time in order to protect Detector from cold weather.
- The PCM is originally a liquid, and it begins to emit heat when the box is left for a long period at low temperature below zero Celsius. Its phase changes to a solid state gradually during the heat radiation.
- The PCM is a reusable material, which means the solid state PCM returns to its liquid state within approximately 2 hours of heating over 35 degrees Celsius. Utilizing this method, the PCM can be used repeatedly.
- The liquid PCM should be stored around room temperature, and can be reused in the same way as the original packing when any transportation is needed.

10.3.4. Component Box Assemble Package**10.3.4.1. AP Box Component**

No	Product Name	Q'ty	Remarks
1	Access Point	1	Default
2	Tether Cable	1	
3	Functional Cable	1	
4	USB Switch Box	1	Optional
5	USB Cable	1	
6	Hand Switch	1	
7	X-Ray Cable	1	

10.3.4.2. Battery Box Component

No	Product Name	Q'ty	Remarks
1	Battery Pack	2	Default
2	Battery Charger	1	
3	Software CD	1	
4	Power Adaptor	1	
5	Power Code	1	
6	LAN Card	1	
7	LAN Cable	1	
8	Adaptor Cable	1	

11. Regulatory Information

11.1. Radio Frequency(RF) Compliance Information

➤ Declaration of Conformity

U.S.A.	FCC Part 15 Subpart B Class A and Part 15 Subpart C (RF Exposure)
Canada	RSS-210

1) For U.S.A. and Canada

• FCC/IC Compliance

This device complies with Part 15 of the FCC Rules and RSS-Gen of IC Rules.

Operation is subject to the following two conditions :

- i. This device may not cause harmful interference.
- ii. This device must accept any interference received, including interference that may cause undesired operations.

• FCC ID

EVS 2430Wi : RNH-EVS2430WI

EVS WPCS : RNH-EVSWPCS

Note :

This equipment has been tested and found to comply with the limits for a Class B digital device, pursuant to part 15 of the FCC Rules.

These limits are designed to provide reasonable protection against harmful interference in a residential installation. This equipment generates, uses, and can radiate radio frequency energy and, if not installed and used in accordance with the instructions, may cause harmful interference to radio communications.

However, there is no guarantee that interference will not occur in a particular Installation.

If this equipment does cause harmful interference to radio or television reception, which can be determined by turning the equipment off and on, the user is encouraged to try to correct the interference by one or more of the following measures:

- Reorient or relocate the receiving antenna.
- Increase the separation between the equipment and receiver.
- Connect the equipment into an outlet of a circuit different from that to which the receiver is connected.
- Consult the dealer or an experienced radio/TV technician for assistance.

- **FCC WARNING:**

Changes or modifications not expressly approved by the party responsible for compliance could void the user's authority to operate the equipment.

This transmitter must not be co-located or operated in conjunction with any other antennas or transmitters.

- **RF Exposure Compliance**

The available scientific evidence does not show that any health problems are associated with using low power wireless devices. There is no proof, however, that these low power wireless devices are absolutely safe. Low power wireless devices emit low levels radio frequency energy (RF) in the microwave range while being used. Whereas high levels of RF can produce health effects (by heating tissue), exposure of low-level RF that does not produce heating effects causes no known adverse health effects. Many studies of low-level RF exposures have not found any biological effects. Some studies have suggested that some biological effects might occur, but such findings have not been confirmed by additional research. EVS 2430Wi Wireless has been tested and found to comply with FCC/IC radiation exposure limits set forth for an uncontrolled equipment and meets the FCC radio frequency (RF) Exposure Guidelines in Supplement C to OET65 and RSS-102 of the IC radio frequency (RF) Exposure rules.

- **Disposal**

Disposal of this product in an unlawful manner may have negative effects on health and on the environment. When disposing this product, therefore, be absolutely sure to follow the procedure which is in conformity with the laws and regulations applicable in your area.



The expected life span of EVS 2430Wi system is about 3 years.



11.2. Labels and Marking on the Equipment

The EVS 2430Wi detector and other components have labels and markings on them.

Their contents and locations are indicated below.

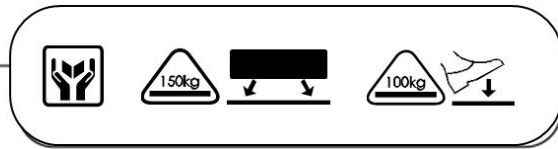
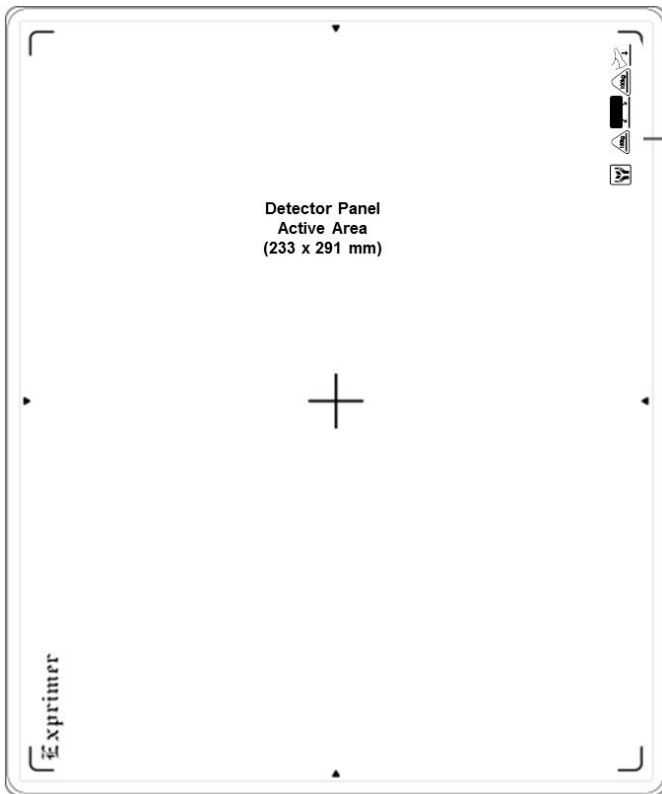
11.2.1. Detector



	This mark indicates that this equipment must be handled with care
	Do not jolt or excessive load to the equipment
	Do not jolt or excessive load to the equipment

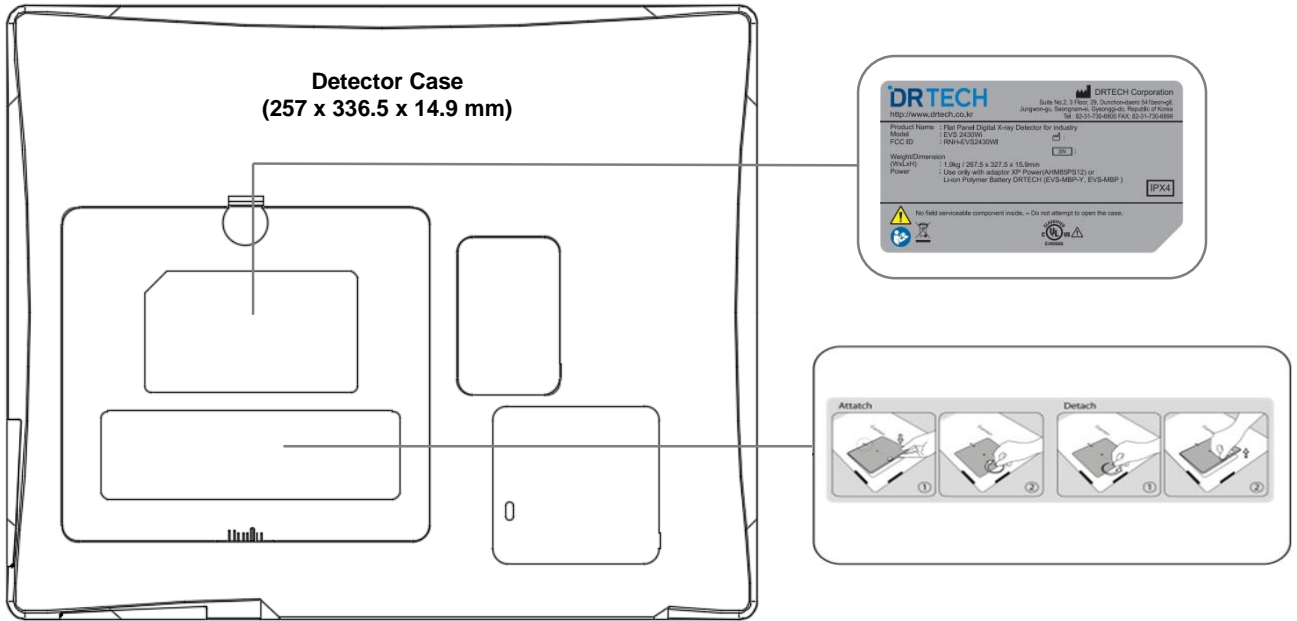

< EVS 2430Wi Standard >

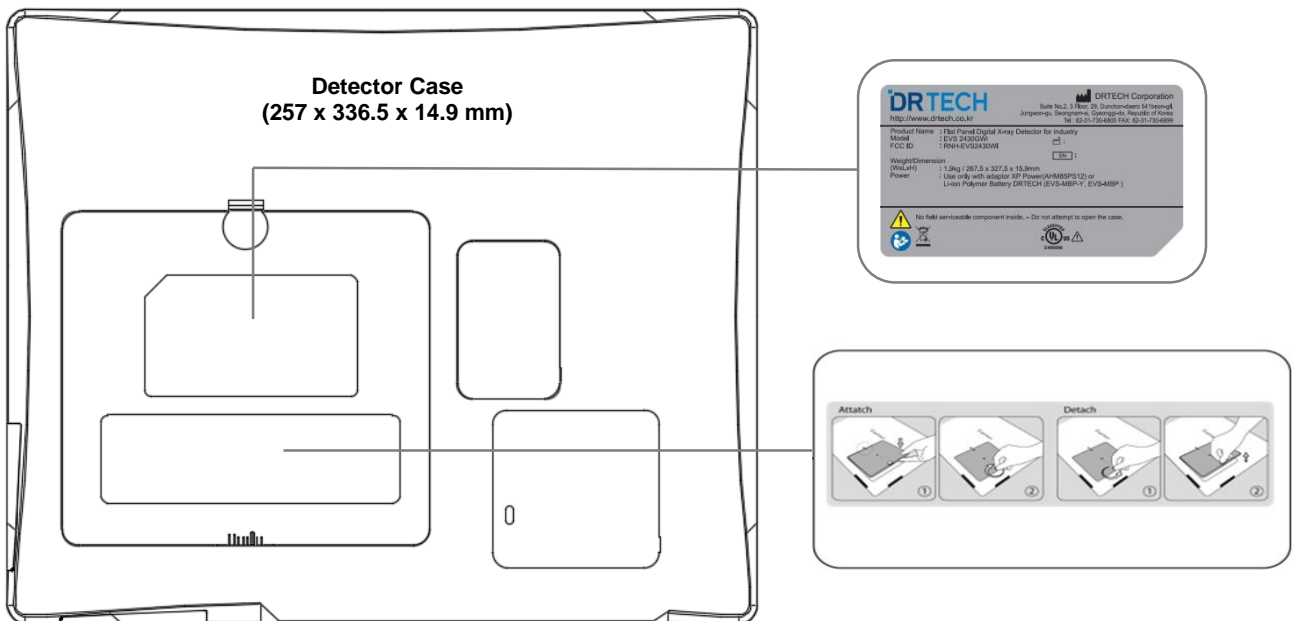

< EVS 2430Wi Gadox Version >

11.2.2. Battery Charger and Battery Pack

11.2.2.1. Battery Charger

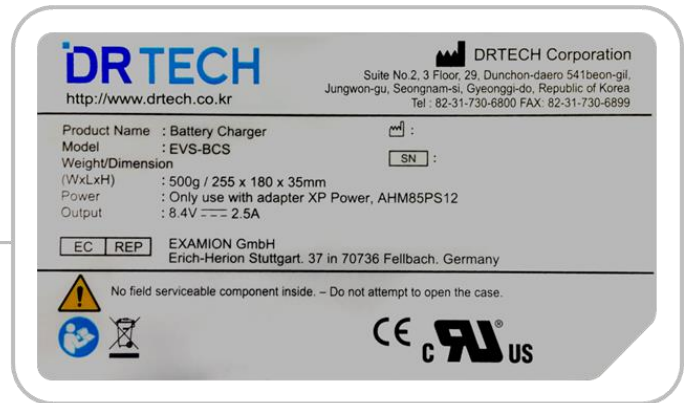
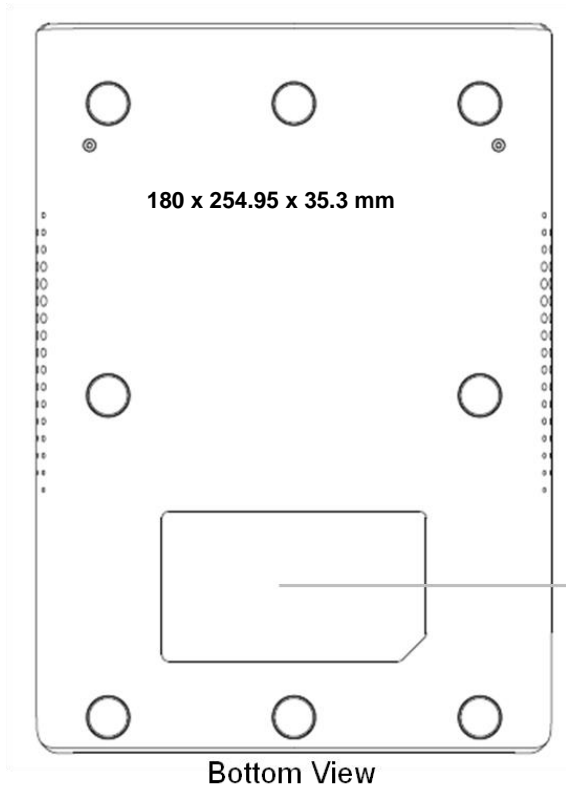



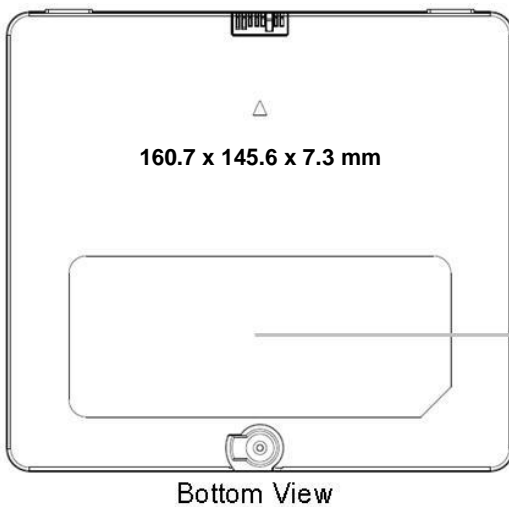



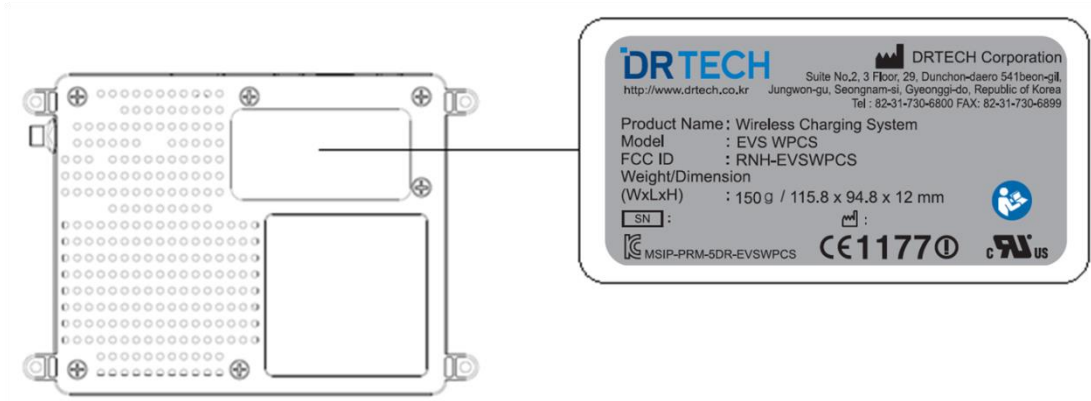









11.2.2.2. Battery Pack



11.2.3. EVS-WPCS



11.2.4. Symbol Description

	Caution : Do not jolt or apply excessive load.
	Non-ionized radiation
	The Waste Electrical and Electronic Equipment Regulations indicates separate collection for electrical and electronic equipments.
	Certification mark that indicates the product complies UL 61010-1 (2012), CSA C22.2 No. 61010-1-12-CAN/CSA (2012) that specifies protection against fire, electric shock, and mechanical hazards.
	
Rx Only	For U.S.A standards Caution : Federal law restricts this device to sale by or on the order of a licensed practitioner.
CE 0120	For European Union (EEC Countries) Hereby, DRTECH Corporation, declares that this EVS-2430WI Wireless is in compliance with the essential requirements and other relevant provisions of Directive 1999/5/EC and 93/42/EEC. "0120" shows the notified body number for MDD.
MANUFACTURED	Year and Month of production
(S/N)	Serial number in six digits
CE1177	This mark shows compliance with the equipment with R&TTE Directive 1999/5/EC
	Protective Earth (Ground)
	Direct Current
	Alternating Current
	Equipotentially.
	Attention, refer to accompanying documents.
	Stand-by
	Read and understand all instructions and warning labels in the product documentation before using the equipment. Keep manual for future reference.
	Product contains specific materials that are suitable for recycling.
	Should be treated with care because if mistreated it might explode.
	Keep away from fire and flames.
	Heavy loading is prohibited.
IPX4	Splashing of water This applies to EVS 2430Wi only.

11.3. Guidance and Manufacturer's Declaration for EMC

Guidelines and Manufacturers : Electromagnetic emission		
<p>The EVS 2430Wi System is used in the following electromagnetic settings. Users of the EVS 2430Wi System should check whether their systems are used in these settings.</p>		
Emission Test	Compliance	Electromagnetic Setting: Guidelines
<p>RF emission CISPR 11</p>	<p>Group 1</p>	<p>Since the EVS 2430Wi System only uses RF energy for internal functions, it has very low RF emissions and normally causes no interference to neighboring electronic devices.</p>
<p>RF emission CISPR 11</p>	<p>Class A</p>	<p>The EVS 2430Wi System is suitable not only in non-household facilities but can also be used by directly connecting to the common low-power network in a building.</p>
<p>Harmonic wave emission CISPR 11</p>	<p>Class A</p>	
<p>Voltage changes /flicker emission CISPR 11</p>	<p>Compliance</p>	

Full Compliance to the IEC 60601-1-2:2007 and the System's Tolerance to EM Waves

The EVS 2430Wi System is used in the following electromagnetic settings.

Users of the EVS 2430Wi System should check whether their systems are used in these settings.

Tolerance Test	IEC 60601 Test Level	Suitability Level	Electromagnetic Setting : Guidelines
Static electricity discharge (ESD) IEC 61000-4-2	+/- 6kV contact +/- 8kV in the air	+/- 6kV contact +/- 8kV in the air	The floor should be in wood, concrete or ceramic tiles. If the floor is in a synthetic material, the relative humidity should be at least 30%.
Suitability in electric over-sprays IEC 61000-4-4	+/- 2kV power supply unit line +/- 1kV input/output line	+/- 2kV power supply unit line +/- 1kV input/output line	The main power's quality should be equal to general commercial or user settings.
Surge IEC 61000-4-11	+/- 1kV line-line +/- 2kV line-earth	+/- 1kV line-line +/- 2kV line-earth	The main power's quality should be equal to general commercial or user settings.
Voltage loss in the power supply, short intermittence and voltage changes IEC 61000-4-11	<5% UT (<95%Dip at the UT), 0.5 cycles 40% UT (60% Dip at the UT), 5 cycles 70% UT (30% Dip at the UT), 25 cycles <5% UT (>95% Dip at the UT), 5 seconds	<5% UT (<95%Dip at the UT), 0.5 cycles 40% UT (60% Dip at the UT), 5 cycles 70% UT (30% Dip at the UT), 25 cycles <5% UT (>95% Dip at the UT), 5 seconds	The main power's quality should be equal to general commercial or user settings. Note : Most components in the EVS 2430Wi System have their power supplied from the uninterrupted power supply. The IEC61000-4-11 only applies to the EVS 2430WI System Power Box.
Magnetic field in the source frequency (50/60Hz) IEC 61000-4-8	3A/m	3A/m	The magnetic field in the source frequency should be equivalent to general commercial or user settings.



Note :

The UT is the main AC voltage before the test standards have been applied.

Guidelines and Manufacturers: Electromagnetic Tolerance

EVS 2430Wi System is used in the following electromagnetic settings.

Users of the EVS 2430Wi System should check whether their systems are used in these settings.

Tolerance Test	IEC 60601 Test Level	Suitability Level	Electromagnetic Setting: Guidelines
Conductive RF IEC61000-4-6 Radioactive RF IEC61000-4-3	3Vrms 150kHz-80MH 3v/m 80MHz-2.5GHz	3Vrms 3v/m	<p>When using a portable or a mobile RF communication equipment, the recommended intervals, which have been calculated using the equations, should be maintained. These calculations should be made in accordance with all of the EVS 2430Wi System's parts (including switches) and its transmitter-receiver's frequency.</p> <p>Recommended intervals :</p> $d = 1.17\sqrt{p}$ $d = 1.17\sqrt{p}80\text{MHz to }800\text{MHz}$ $d = 2.33\sqrt{p}800\text{MHz to }2.5\text{GHz},$ <p>where p is the transmitter-receiver's maximum power rating in watts (W) and d is the recommended interval.</p> <p>The magnetic field strength in the fixed RF receiver, which has been determined in the EM wave walkdown¹, should be lower than the compliance standards of each frequency range².</p> <p>Interference may occur around the equipment and is expressed as the symbol shown below.</p> <div style="text-align: center;">  </div>

Note 1 :

The high-frequency range is applied at 80MHz to 800MHz.

Note 2 :

This guideline does not apply in all situations. Electromagnetic waves may be affected through absorption and reflection from structures, objects and people.

Guidelines and Manufacturers: Electromagnetic Tolerance

It is very difficult to accurately predict the magnetic field strength of wireless (mobile/wireless) telephones, land mobile radio base stations, amateur wireless channels, AM, FM wireless and TV broadcasting systems. To assess electromagnetic settings using fixed RF receivers, area walk-down is needed. If the magnetic field strength measured at the point, where the EVS 2430Wi System is used, exceeds the applicable RF compliance level, you should check whether the EVS 2430Wi System is operating normally. If any performance abnormality is observed, additional action may be needed such as changing the EVS 2430Wi System's direction or location. At the frequency range between 150kHz and 80MHz, the magnetic field strength should be less than 3v/m.

Recommended Intervals between the EVS 2430Wi System and the Portable or Mobile RF Communications Equipment

The EVS 2430Wi System should be used in an electromagnetic setting where RF communication interferences are controlled. Users of the EVS 2430Wi System should maintain the minimum intervals between the System and the portable or mobile RF communications equipments to prevent electromagnetic interferences more effectively.

Maximum output power rating of the transceiver - receiver Watts	Interval depending on the transceiver-receiver's frequency meters		
	150kHz to 80MHz $d = 1.17\sqrt{p}$	80MHz to 800MHz $d = 1.17\sqrt{p}$	800MHz to 2.5GHz $d = 2.33\sqrt{p}$
0.01	0.117	0.117	0.233
0.1	0.37	0.37	0.737
1	1.17	1.17	2.33
10	3.7	3.7	7.36
100	11.7	11.7	23.3

For maximum power voltages of receivers are not shown in the above list, the recommended interval, d(m), can be calculated by using the equation used for the receiver's frequency. The p is the transmitter-receiver's maximum power rating in watts (W).

Note 1 :

The high-frequency range is applied at 80MHz to 800MHz.

Note 2 :

This guideline does not apply in all situations. Electromagnetic waves may be affected through absorption and reflection from structures, objects and people.

12. Warranty

DRTECH Corporation warrants that this product will be free from defects in materials and workmanship for a period of twelve (12) months from the date of delivery. If any such product proves to be defective during this warranty period, DRTECH Corporation at its options, will repair the defective product without charge for parts and labor, or will provide a replacement in exchange for the defective product. In order to obtain service under this warranty, customer must notify DRTECH Corporation of the defect before the expiration of the warranty period and make suitable arrangements for the performance of service. Customer shall be responsible for packaging and shipping the defective product to the service center designated by DRTECH Corporation with shipping charges prepaid. DRTECH Corporation shall pay for the return of the product to customer if the shipment is to a location within the country in which the DRTECH Corporation designated service center is located. Customer shall be responsible for paying all shipping charges, duties, taxes, and any other charges for products returned to any other locations.

This warranty shall not apply to any defect, failure, or damage caused by improper or inadequate maintenance and care. DRTECH Corporation shall not be obligated to furnish service under this warranty to repair damage resulting from attempts by personnel other than DRTECH Corporation or its representatives to install, repair, or service this product, to repair damage resulting from improper use or connection to incompatible equipment or power source; or to service a product that has been modified or integrated with other products when the effect of such modification or integration increases the time or difficulty of servicing the product.

THIS WARRANTY IS GIVEN BY DRTECH Corporation WITH RESPECT TO THIS PRODUCT IN LIEU OF ANY OTHER WARRANTIES, EXPRESS OR IMPLIED. DRTECH Corporation AND ITS VENDOR DISCLAIM ANY IMPLIED WARRANTIES OF MERCHANTABILITY OR FITNESS FOR A PARTICULAR PURPOSE. DRTECH Corporation RESPONSIBILITY TO REPAIR OR REPLACE DEFECTIVE PRODUCTS IS THE SOLE REMEDY PROVIDED TO THE CUSTOMER FOR BREACH OF THIS WARRANTY. DRTECH AND ITS VENDORS WILL NOT BE LIABLE FOR ANY INDIRECT, SPECIAL, INCIDENTAL, OR CONSEQUENTIAL DAMAGES IRRESPECTIVE OF WHETHER DRTECH Corporation OR THE VENDOR HAS ADVANCE NOTICE OF THE POSSIBILITY OF SUCH DAMAGES.

There are no warranties which extend beyond the description mentioned in this document.

➤ **Revision History**

Revision	Date	Descriptions
00	Feb.24.2017	Initial Release



DRTECH Corporation.

Suite No.2 3 Floor, 29

Dunchon-daero541beon -gil,

Jungwon-gu, Seongnam-si, Gyeonggi-do, Republic of Korea

Web Site : <http://www.drtech.co.kr>

Customer Support Team

E-mail : drtech@drtech.co.kr

Tel : +82 31 730 6805 / Fax : +82 31 730 6899



EXAMION GmbH

Erich-Hherion Stuttgart. 37 in 70736 Fellbach. Germany