

USER'S MANUAL

Home&MobileDVDPlayer



Precaution

IMPORTANT



The lightning flash with arrowhead symbol, within an equilateral triangle, is intended to alert the user to the presence of uninsulated dangerous voltage within the product's enclosure that may be of sufficient magnitude to constitute a risk of electric shock to persons.



CAUTION: TO PREVENT THE RISK OF ELECTRIC SHOCK DO NOT REMOVE COVER (OR BACK). NO USER SERVICEABLE PARTS INSIDE. REFER SERVICING TO QUALIFIED SERVICE PERSONNEL.



The exclamation point within an equilateral triangle is intended to alert the user to the presence of important operating and maintenance (servicing instructions in the literature accompanying the appliance).

Note : This equipment has been tested and found to comply with the limits for a Class B digital device, pursuant to Part 15 of the FCC Rules. These limits are designed to provide reasonable protection against harmful interference in a residential installation. This equipment generates, uses and can radiate radio frequency energy and, if not installed and used in accordance with the instructions, may cause harmful interference to radio communications. However, there is no guarantee that interference will not occur in a particular installation. If this equipment does cause harmful interference to radio or television reception, which can be determined by turning the equipment off and on, the user is encouraged to try to correct the interference by one or more of the following measures:

- Reorient or relocate the receiving antenna.
- Increase the separation between the equipment and receiver.
- Connect the equipment into an outlet on a circuit different from that to which the receiver is connected.
- Consult the dealer or an experienced radio/TV technician for help.

CAUTION

This product satisfies FCC regulations when shielded cables and connectors are used to connect the unit to other equipment. To prevent electromagnetic interference with electric appliances such as radios and televisions, use shielded cables and connectors for connections.

CAUTION

- Use of controls or adjustments or performance of procedures other than those specified here in may result in hazardous radiation exposure.
- The use of Optical instruments with this product will increase eye hazard

WARNING TO PREVENT FIRE OR SHOCK HAZARD, DO NOT EXPOSE THIS APPLIANCE TO RAIN OR MOISTURE.

CAUTION

This product contains a laser diode of higher class than 1. To ensure continued safety, do not remove any covers or attempt Refer all servicing to qualified personnel.

The following caution appears on rear of the unit.



CAUTION : LASER RADIATION WHEN OPEN. AVOID EXPOSURE TO BEAM.

VOICHT : SICHTBARE UND UNSICHTBARE LASERSTRAHLUNG. WENN ABDECKUNG GEÖFFNET. NICHT DEM STRAHL AUSETZEN.

ADVARSEL : LASERSTRÅLING VED ÅBNING UNGDÅ UDSÆTTELSE FOR STRÅLING.

WARNING : LASERSTRÅLING NÄR DENNA DEL ÄR ÖPPNAD BETRÄKTA EJ STRÅLEN.

VARO! : AVATTAESSA ALTISTUT LASERSÄTBL YLLE ÄLÄ KATSO SÄTEESIN

CAUTION VISIBLE AND INVISIBLE LASER RADIATION WHEN OPEN. AVOID DIRECT EXPOSURE TO BEAM (WARNING LOCATION: INSIDE ON LASER COVERSHEILD)



This product is in conformity with the EMC directive and low-voltage directive.

This product incorporates copyright protection technology that is protected by method claims of certain U. S. Patents and other intellectual property rights owned by Macrovision Corporation and other rights owners. Use of this copyright protection technology must be Authorized by Macrovision Corporation, and is intended for home and other limited viewing uses only unless otherwise authorized by Macrovision corporation. Reverse engineering or disassembly is prohibited.

Manufactured under license from Dolby Laboratories. "Dolby" and the double-D symbol are trademarks of Dolby Laboratories.

"DTS" and "DTS Digital Surround" are trademarks of Digital Theater Systems, Inc.

Important Safety Instruction

- **READ INSTRUCTIONS** - All the safety and operating instructions should be read before the product is operated.
- **RETAIN INSTRUCTIONS** - The safety and operating instructions should be retained for future reference.
- **HEED WARNINGS** - All warnings on the product and in the operating instructions should be adhered to.
- **FOLLOW INSTRUCTIONS** - All operating and use instructions should be followed.
- **CLEANING** - Unplug this product from the wall outlet before cleaning. The product should be cleaned only with a polishing cloth or a soft dry cloth. Never clean with furniture wax, benzene solvents or other volatile liquids since they may corrode the cabinet.
- **ATTACHMENTS** - Do not use attachments not recommended by the product manufacturer as they may cause hazards.
- **WATER AND MOISTURE** - Do not use this product near water - for example, near a bathtub, wash bowl, kitchen sink, or laundry tub; in a wet basement; or near a swimming pool; and the like.
- **ACCESSORIES** - Do not place this product on an unstable cart, stand, tripod, bracket, or table. The product may fall, causing serious injury to a child or adult, and serious damage to the product. Use only with a cart, stand, tripod, bracket, or table recommended by the manufacturer, or sold with the product. Any mounting of the product should follow the manufacturer's instructions, and should use a mounting accessory recommended by the manufacturer.
- **CART** - A product and cart combination should be moved with care. Quick stops, excessive force, and uneven surfaces may cause the product and cart combination to overturn.
- **VENTILATION** - Slots and openings in the cabinet are provided for ventilation and to ensure reliable operation of the product and to protect it from overheating, and these openings must not be blocked or covered. The openings should never be blocked by placing the product on a bed, sofa, rug, or other similar surface. This product should not be placed in a built-in installation such as a bookcase or rack unless proper ventilation is provided or the manufacturer's instructions have been adhered to.
- **POWER SOURCES** - This product should be operated only from the type of power source indicated on the marking label. If you are not sure of the type of power supply to your home, consult your product dealer or local power company.
- **LOCATION** - The appliance should be installed in a stable location.
- **NONUSE PERIODS** - The power cord of the appliance should be unplugged from the outlet when left unused for a long period of time.



- GROUNDING OR POLARIZATION

- If this product is equipped with a polarized alternating current line plug (a plug having one blade wider than the other), it will fit into the outlet only one way. This is a safety feature. If you are unable to insert the plug fully into the outlet, try reversing the plug. If the plug should still fail to fit, contact your electrician to replace your obsolete outlet. Do not defeat the safety purpose of the polarized plug.
- If this product is equipped with a three-wire grounding type plug, a plug having a third (grounding) pin, it will only fit into a grounding type power outlet. This is a safety feature. If you are unable to insert the plug into the outlet, contact your electrician to replace your obsolete outlet. Do not defeat the safety purpose of the grounding type plug.

- **POWER-CORD PROTECTION** - Power-supply cords should be routed so that they are not likely to be walked on or pinched by items placed upon or against them, paying particular attention to cords at plugs, convenience receptacles, and the point where they exit from the product.

- **OUTDOOR ANTENNA GROUNDING** - If an outside antenna or cable system is connected to the product, be sure the antenna or cable system is grounded so as to provide some protection against voltage surges and built-up static charges. Article 810 of the National Electrical Code, ANSI/NFPA 70, provides information with regard to proper grounding of the mast and supporting structure, grounding of the lead-in wire to an antenna discharge unit, size of grounding conductors, location of antenna-discharge unit, connection to grounding electrodes, and requirements for the grounding electrode. See Figure A.

- **LIGHTNING** - For added protection for this product during a lightning storm, or when it is left unattended and unused for long periods of time, unplug it from the wall outlet and disconnect the antenna or cable system. This will prevent damage to the product due to lightning and power-line surges.

- **POWER LINES** - An outside antenna system should not be located in the vicinity of overhead power lines or other electric light or power circuits, or where it can fall into such power lines or circuits. When installing an outside antenna system, extreme care should be taken to keep from touching such power lines or circuits as contact with them might be fatal.

- **OVERLOADING** - Do not overload wall outlets, extension cords, or integral convenience receptacles as this can result in a risk of fire or electric shock.

- **OBJECT AND LIQUID ENTRY** - Never push objects of any kind into this product through openings as they may touch dangerous voltage points or short-out parts that could result in a fire or electric shock. Never spill liquid of any kind on the product.

- **SERVICING** - Do not attempt to service this product yourself as opening or removing covers may expose you to dangerous voltage or other hazards. Refer all servicing to qualified service personnel.

- **DAMAGE REQUIRING SERVICE** - Unplug this product from the wall outlet and refer servicing to qualified service personnel under the following conditions:

- When the power-supply cord or plug is damaged.
- If liquid has been spilled, or objects have fallen into the product.
- If the product has been exposed to rain or water.
- If the product does not operate normally by following the operating instructions. Adjust only those controls that are covered by the operating instructions as an improper adjustment of other controls may result in damage and will often require extensive work by a qualified technician to restore the product to its normal operation.
- If the product has been dropped or damaged in any way.
- When the product exhibits a distinct change in performance - this indicates a need for service.

- **REPLACEMENT PARTS** - When replacement parts are required, be sure the service technician has used replacement parts specified by the manufacturer or have the same characteristics as the original part. Unauthorized substitutions may result in fire, electric shock, or other hazards.

- **SAFETY CHECK** - Upon completion of any service or repairs to this product, ask the service technician to perform safety checks to determine that the product is in proper operating condition.

- **WALL OR CEILING MOUNTING** - The product should not be mounted to a wall or ceiling.

- **HEAT** - The product should be situated away from heat sources such as radiators, heat registers, stoves, or other products (including amplifiers) that produce heat.



Warning

Watch out for using Mobile DVD Player while driving
(Watching TV while driving are prohibited)

Table of contents

Before You Start

Caution on Handling Discs	5
What's in the box	7
Preparing the Remote Control	7
Using the remote control	8
Compatible Discs	9

Control & Display

Front Panel	11
Display	12
Rear Panel	13
Remote Control Unit.....	14

Getting Started

Power Connection	16
Connecting to a TV	17
Connecting to a Car Audio System	18
Connecting External A/V Input	19
Connecting to a Dolby Digital.....	20
Connecting to Car Radio System	21
Connecting to Component Video Input	22

Basic Operation

Playing DVD Video disc	23
Playing MP3 discs	25
Playing Kodak CD and JPEG file play	26
Fast Forward/Backward	27
Skip Forward/Backward	27
Slow Forward/Backward	28
Frame by Frame Playback	28

Advanced Operation

OSD (On-Screen Display)	29
Selecting Audio Languages	29
Selecting Subtitles	30
Repeating a Title, Chapter, Track... ..	31
Repeating a specific section (A-B)	31
Program Play	31
Zooming a Picture	31
Switching the Camera Angle	32
Direct Search (GO TO)	33

Using the Setup Menu

Basic Operations	36
General Setup	37
Audio Setup	39
Video Setup	41
Preference Setup	42
Password Setup.....	44

Additional Information

Specifications	45
Troubleshooting	46

Cautions on handling discs

▶ Disc

Only the discs including the mark shown on page 7 can be played on the DVD player. Note, however, that discs with special shapes (heart-shaped discs, hexagonal discs, irregular discs, etc.) cannot be played on the DVD player. Do not attempt to play such discs, as they may damage the player.



▶ Holding Discs

Avoid touching the surface of discs when loading and unloading them.



Be careful not to get fingerprints on the signal surface (the side which shines in rainbow colors.)

▶ Cleaning Discs

- Fingerprints or dirt on the may lower sound and picture quality or cause breaks in playback. Wipe off fingerprints or dirt
- Use a commercially available disc cleaning set or a soft cloth to wipe off fingerprints or dirt.



Wipe gently from the middle outwards



Do not wipe with a circular motion



Note

- Do not use record spray or antistatic. Also do not use volatile chemicals such as benzene or thinner

Before You Start

▶ Cautions on handling discs

- Do not get fingerprints, grease or dirt on discs.
- Be especially careful not to scratch discs when removing them from their cases.
- Do not bend discs.
- Do not heat discs.
- Do not enlarge the center hole.
- Do not write on the labeled (printed) side with a ball-point pen or pencil.
- Water droplets may form on the surface if the disc is moved suddenly from a cold place to a warm one. Do not use hairdryer, etc., to dry the disc.

▶ Caution on Loading Discs

- Only load one disc at a time. Loading one disc on top of another may result in damage or scratch the discs.
- Do not load cracked or warped discs or discs that have been fixed with adhesive, etc.
- Do not use discs on which the adhesive part of cellophane tape or glue used to attach the label is exposed, or discs with traces of tape or labels that have been peeled, or discs with traces of tape or label that have been peeled off. Such discs may get stuck inside the player, resulting in damage

Before You Start

What's in the box

Thank you for buying this product. Please confirm that the following accessories are in the box when you open it.

▶ Accessories



Warning : DC cable must be connected to ACC power line

Preparing the Remote Control

Insert the batteries into the remote controller so you can use it to operate the DVD player

- 1 Open the battery cover.
- 2 Insert batteries. (AAA size)
- Make sure to match the + and - on the batteries to the marks inside the battery compartment.
- 3 Close the cover.



Before You Start



Warning

- Improper use of batteries may cause battery leakage and corrosion.
- To operate the remote control correctly, follow the instructions.
- Don't insert the batteries into the remote control in the wrong direction.
- Don't charge, heat, open, or short-circuit the batteries.
- Don't throw the batteries into fire.
- Don't leave dead or exhausted batteries in the remote control.
- Don't use different types of batteries together, or mix old and new batteries.
- If you do not use the remote control for a long period of time, remove the batteries to avoid possible damage from battery corrosion.
- If the remote control does not function correctly or if the operating range becomes reduced, replace all batteries with new ones.
- If battery leakage occurs, wipe the battery liquid from the battery compartment, then insert new batteries.
- The batteries should last about one year with normal use.

Using the remote control

The effective operating range of the remote control is 5~7m, and 30 left and right degrees from the IR receiver.

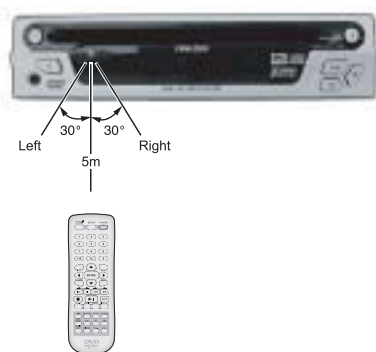

Note

- Direct the remote control at the remote sensor of the DVD player.
- Don't drop or give the remote control a shock.
- Don't leave the remote control near extremely hot or humid place.
- Don't spill water or put anything wet on the remote control.
- Don't open the remote control.

Before You Start

Compatible Discs

The types of discs listed on the table below can be used on the DVD player. The marks are indicated on the disc labels or jackets.

Digital Video discs



- Single sided or double sided discs.
- Single layer or dual layer discs.
- Dolby Digital, DTS, MPEG or Linear PCM digital audio.
- MPEG-2 digital video Discs are generally divided into one or more title. Titles may be further subdivided into chapters.

DVD-R, DVD-RW, DVD+R, DVD+RW



- This unit can play DVD-R/ RW/ +R/ +RW discs recorded as DVD video format.

DVD-R, DVD-RW, DVD+R, DVD+RW



- 12cm or 8cm discs.
- Linear PCM digital audio
- CD-Audio, CD-R and CD-RW formatted CDs are divided into tracks.
(This unit can play CD-R and CD-RW discs recorded on CD Audio or Video CD format, or with MP3 audio files)

Video CD



- 12cm or 8cm discs.
- MPEG-1 digital audio.
- MPEG-1 digital video.
- Video CDs are divided into tracks.

Picture CD



- Picture 12cm discs

Before You Start

▶ MP3 compatibility information

- The CD-ROM must be ISO 9660 compatible.
- Mono or stereo MPEG-1 Audio Layer 3 format, 32 or 44.1 or 48kHz fixed bit-rate. Incompatible files will not play.
- Compatible with variable bit-rate (VBR) files.
- This player is compatible with multi-session discs.
- Audio encoded at 128Kbps should sound close to regular audio CD quality. Although this player will play 48K to 320k bit-rate.
- MP3 tracks, the sound quality becomes. Noticeably worse at lower bit rates.

▶ Region code

Your DVD player is designed and manufactured to respond to the region management information that is recorded on a DVD disc.

All DVD Video discs carry a region mark on the case somewhere that indicates which region of the world the disc is compatible with. Your DVD player also has a region mark, which you can find on the rear panel. Discs from incompatible regions will not play in this player. Discs marked ALL will play in any player.

Front Panel Control



- 1 POWER**
Turns the power on/off.
- 2 DISC IN / OUT HOLE**
Discs are inserted and ejected here.
- 3 EJECT**
Press EJECT to eject the discs.
- 4 PLAY/PAUSE**
Starts disc play and pause
- 5 SKIP Forward/Reverse**
Plays skip forward/reverse.
- 6 REMOTE SENSOR**
Receives a IR signal from the remote control
- 7 DISPLAY WINDOW**
Display information about the current state of the player and the disc.
(See next page.)
- 8 STEREO JACK FOR CAR PACK / AV IN**
Plug in car pack jack for stereo audio output.
Plug in video and stereo audio input.
- 9 MUTE**
Turns the audio outputs on/off.

Control & Display

Display

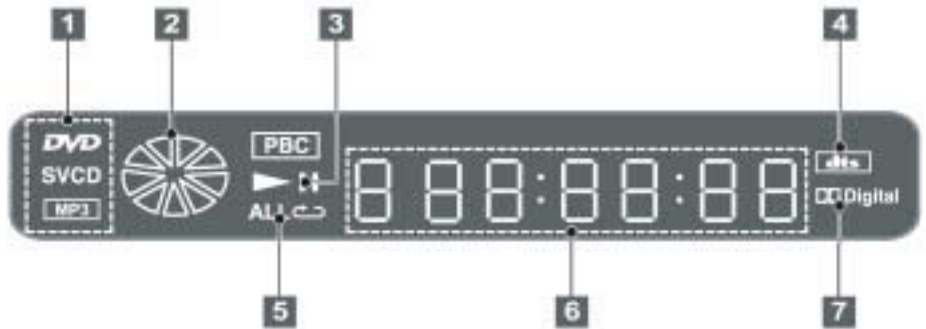

- 1 DVD/SVCD/MP3/PBC**
Illuminates the type of the disc loaded.
- 2 ROTATION**
Rotates when the disc is spinning.
- 3 PLAY/PAUSE**
Indicates the current operation mode.
- 4 DTS**
Indicates that the audio type of the disc under play is DTS.
- 5 Repeat/ALL**
Indicates the current repeat play mode.
- 6 TIME**
Indicates time information and displays information about operation such as PLAY, STOP, LOAD, NO DISC, etc.
- 7 Dolby**
Indicates that the audio format of the disc under play is Dolby digital.

Rear Panel

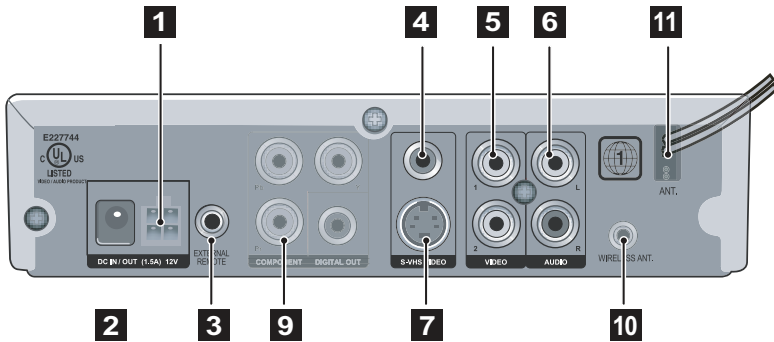

1 DC INPUT

Use the DC cable to connect the only 12V battery

2 DC INPUT

Use the cigar cable to connect the cigar jack.
Use the AC adapter to connect the AC Power. (optional)

3 EXTERNAL REMOTE CONNECTOR

Use the External Remote Control to Connect the Irmodule

4 DIGITAL AUDIO OUT (Coaxial)

Use coaxial digital cable to connect to a compatible Dolby Digital receiver

5 VIDEO OUT

Use a video cable to connect one of these jacks to the Video input on your TV.

6 AUDIO OUT (L/R)

Connect to the Audio input jacks of your TV, audio/video receiver

7 S-VIDEO OUT

Use the S-VIDEO cable to connect this jack to the S-VIDEO.

8 VGA CONNECTOR (VGA option)

Connect the VGA monitor to this connector. In VGA mode you can see progressive scan video.

9 COMPONENT VIDEO OUT

Connect the component video input of TV system. It can out Y/Pb/Pr or RGB video output. At this video mode progressive scan is also possible.

10 ANTENNA CONNECTOR (Wireless FM Transmitter model)

To connect antenna for internal wireless FM transmitter. It can out DVD player's audio signal to your car radio system. At this mode not necessary to connect any wiring for DVD player's audio signal













11 ANTENNA CABLE (Wired FM Transmitter model)

To connect car radio's antenna and car radio antenna input for use wired FM transmitter. It can switching car antenna signal during DVD player's operation, so radio noise will decrease.













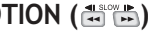





Control & Display

Remote Control



- 1 OPEN / CLOSE** ()
Ejects the disc
- 2 SETUP** ()
Use to set various functions according to individual preference
- 3 POWER** ()
Turns on or off the DVD player.
- 4 NUMBER**
Press the number button. Use the +10 button to input numbers of 10 or over.
- 5 TITLE** ()
Use the TITLE button to display the title screen included on DVD discs.
- 6 MENU** ()
Use the MENU button to display the menu screen included on a DVD discs.
- 7 RETURN** ()
Use the RETURN button to return to the previous menu screen.
- 8 MUTE** ()
Turns on/off audio outputs.
- 9 ARROW BUTTONS** ()
Use to move to the desired menu.
- 10 CL(CLEAR)** ()
Press this to clear numbers that you have input.
- 11 ENTER** ()
Selects menu items and begins disc play.
- 12 STOP** ()
Stop video playback in DVD video and video CD mode.
- 13 PLAY/PAUSE** ()
Play or pause video and audio media.

Control & Display

- 14 STEP** ()
Play one frame at a time during pause.
- 15 SKIP** ()
Select previous track, title, chapter, and index or beginning of current track, title, chapter, index.
Select next track, title, chapter, index.
- 16 SEARCH** ()
Press for fast backward scanning during playback.
Press for fast forward scanning during playback.
- 17 SLOW MOTION** ()
Press for slow backward scanning during pause.
Press for slow forward scanning during pause
- 18 GOTO** ()
Used to go to the chapter, track or song of the disc you want
- 19 SUB-T** ()
Changes the subtitle language to another available language or sets OFF (if the disc supports multiple subtitle languages).
- 20 AUDIO** ()
Changes the audio language to another available language (if the disc supports multiple audio languages).
- 21 ANGLE** ()
View with a different frame angle. (This button is available only on multiple angle DVDs.)
- 22 DISPLAY** ()
Shows the information about time, play state.
- 23 A-B** ()
Repeating a specific section.
- 24 PROGRAM** ()
Programs the desired titles and tracks of DVD and CD-DA.
- 25 ZOOM** ()
Press this to enlarge the image.
- 26 TV MODE** ()
Changes the NTSC/PAL/MULTI /GA (option) mode.
- 27 PLAY MODE** ()
Repeats part or all of a chapter, title, track, or an entire disc
- 28 PBC** ()
Turn on and off the PBC function in video CD mode
- 29 3D** ()
Virtual 3D Sound Control
- 30 AUX** ()
Changes the DVD mode and external AV input mode
- 31 AUDIO ONLY** ()
Turns off the screen for audio only mode
- 32 DIMMER** ()
Set the display brightness (HALF, FULL, OFF).
- 33 VOL+ / VOL -** ()
Increases and decreases the volume.

Getting Started

Power Connections

- 1 When using the Cigar cable
 - Make sure that input voltage is 12-24V
 - Connect to DC INPUT using the include cigar cable.

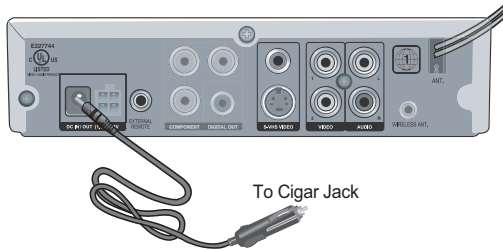

- 2 When connecting the DC power cable.
 - DC cable - This installation should be made by a qualified service person and should confirm to all local codes.
 - Connect the terminal of red cable to DC 12-24V, and the terminal of black cable to ground.
- 3 When using the DVD player at home
 - Connect to DC INPUT using the AC adapter.(optional)



Note

- When you connect the DVD player to your TV, be sure to turn off the power and unplug both units from the wall outlet before making any connections.
- Connect the DVD player to your TV directly. If you connect the DVD player to a VCR, the playback picture will be distorted because DVD video discs are copy protected.
- Fuse Replacement Marking - Replace only with same type (3 A, 250 V) and ratings of fuse. For continued protection against fire hazard.

Connecting to a TV

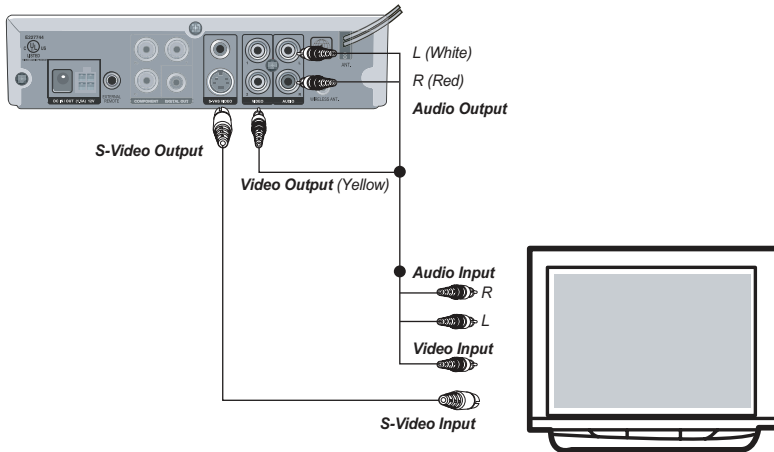

▶ Connect the DVD player to your TV.

- 1 VConnect the AUDIO CABLES between the AUDIO OUT L and R jacks on the back of your DVD player and the corresponding AUDIO INPUT jacks on your TV.
- 2 Connect the VIDEO CABLE between the VIDEO OUT jack on the back of your DVD player and the corresponding VIDEO INPUT jack on your TV. (if you have S-VIDEO jack on your TV, connect to the S-VIDEO jack on your DVD player. You will watch a better picture.



Warning

- Do not set the Digital Audio Output of this DVD player to "SPDIF/PCM" unless you are connecting the DIGITAL AUDIO jack of this DVD player to an AV decoder that has Dolby Digital decoding function. High volume sound may damage your hearing as well as speakers.

Getting Started

Connecting to a Car Audio System

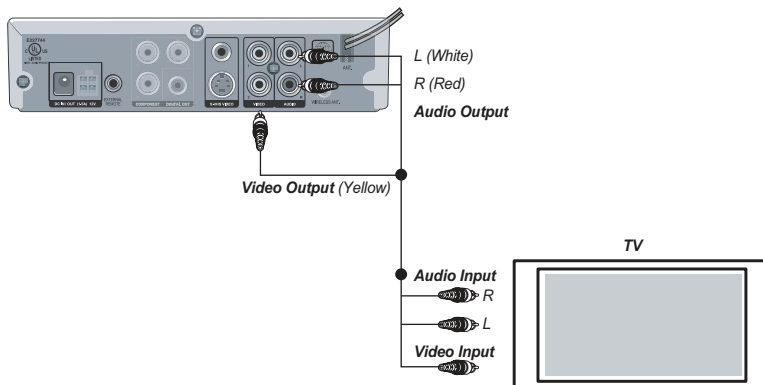

▶ Connecting to a Car Audio System.

- 1 Connect the AUDIO CABLES between the AUDIO OUT L and R jacks on the back of your DVD player and the corresponding AUDIO INPUT jacks on your audio system.
- 2 Connect the VIDEO CABLE between the VIDEO OUT jack on the back of your DVD player and the corresponding VIDEO INPUT jack on your TV.



Note

- When you connect the DVD player to other equipment, be sure to turn off the power and unplug all of the equipment from the power source before making any connections.
- If you place the DVD player near a tuner or radio, the radio broadcast sound might be distorted. In this case, move the DVD player away from the tuner and radio.
- Be sure to adjust the receiver's volume to a moderate listening level. Otherwise, the speakers may be damaged by a sudden high volume sound.
- Turn off the receiver before you connect or disconnect the DVD player's power cord. If you leave the receiver power on the speakers may be damaged.

Connecting External A/V Input

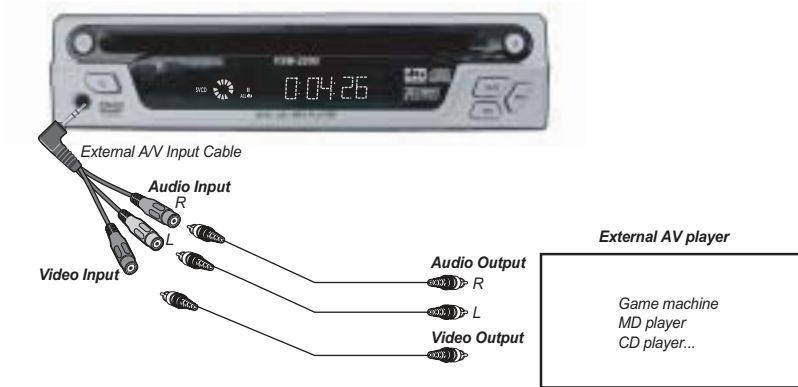

▶ Connecting External A/V Input

1 This function can connect your another A/V (Game machine, MD...) to monitor and car audio system. Only connect A/V input cable to your DVD player's AUDIO OUT/AV IN socket than DVD player changes to external A/V input mode. If A/V has only audio signals cannot change to external A/V input mode. You can change the mode by remote controller's AUX key.

Caution : This function cannot operate in VGA mode (VGA option)

Getting Started

Connecting to a Dolby Digital System

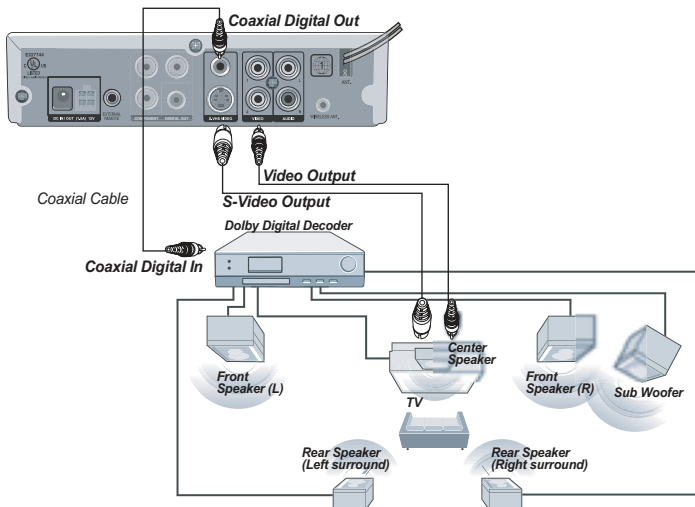

▶ Dolby Digital

Dolby Digital is the surround sound technology used in theaters showing the latest movies, and is now available to reproduce this realistic effect in the home. You can enjoy motion picture and live concert DVD video discs with this dynamic realistic sound by connecting the DVD player to a 6 channel receiver equipped with a Dolby Digital decoder or Dolby Digital processor.

- 1 Connect the COAXIAL DIGITAL OUT (black) jack on the back of your DVD player to the DIGITAL IN jack for the Decoder or AV amplifier.
- 2 Page 17-18 for details on video connection to TV



Note

- When you connect the DVD player to other equipment, be sure to turn off the power and unplug all of the equipment from the wall outlet before making any connections.
- Turn off the receiver before you connect or disconnect the DVD player's power cord. If you leave the receiver power on, the speakers may be damaged.