

Use & Care Installation Instructions

Microwave with Built-in Kit

Models: **DMT2420B / DMT2420R / DMT2420S**



IMPORTANT INFORMATION

- ◆ Installation Instructions
- ◆ Operation Instructions
- ◆ Cooking Guides
- ◆ Specifications

Please Read Before Using Your Microwave Oven

dacor®

The life of the kitchen™

FOR CUSTOMER ASSISTANCE

To aid in reporting this microwave oven in case of loss or theft, please record below the model number and serial number located on the unit. We also suggest you record all the information listed and retain for future reference.

| | |
|------------------------|---------------------|
| MODEL NUMBER _____ | SERIAL NUMBER _____ |
| DATE OF PURCHASE _____ | |
| DEALER _____ | TELEPHONE _____ |
| SERVICER _____ | TELEPHONE _____ |

TO PHONE: **1(800)793-0093**

TO WRITE: **DACOR INC.
1440 Bridge Gate Drive
Diamond Bar, CA 91765**

Please provide the following information when you write or call: model number, serial number, date of purchase, your complete mailing address (including zip code), your daytime telephone number (including area code) and description of the problem.

TO ACCESS INTERNET: www.dacor.com

PRECAUTIONS TO AVOID POSSIBLE EXPOSURE TO EXCESSIVE MICROWAVE ENERGY

- (a) Do not attempt to operate this oven with the door open since open-door operation can result in harmful exposure to microwave energy. It is important not to defeat or tamper with the safety interlocks.
- (b) Do not place any object between the oven front face and the door or allow soil or cleaner residue to accumulate on sealing surfaces.
- (c) Do not operate the oven if it is damaged. It is particularly important that the oven door close properly and that there is no damage to the: (1) door (bent), (2) hinges and latches (broken or loosened), (3) door seals and sealing surfaces.
- (d) The oven should not be adjusted or repaired by anyone except properly qualified service personnel.

CONTENTS

- 2 For Customer Assistance
- 2 Precautions to Avoid Possible Exposure to Excessive Microwave Energy
- 3 Contents
- 4 Product Warranty
- 5 Important Safety Instructions
- 6-7 Installation Instructions
- 7 Grounding Instructions
- 8-10 Information You Need to Know
 - 8 About Your Oven
 - 8 About Food
 - 9 About Utensils and Coverings
 - 9 About Children and the Microwave
 - 10 About Microwave Cooking
 - 10 About Safety
- 11 Part Names
- 12 Control Panel
- 13-14 Introduction to Touch Screen
- 14-15 Before Operating
 - 14 To Set The Clock
 - 15 Stop/Clear
- 15-16 Manual Operation
 - 15 High Power Cooking
 - 16 Variable Power Cooking
 - 16 Multiple Sequence Cooking
- 17 SENSOR MODES
 - 17 REHEAT - POPCORN - BAKED POTATOES
 - 17 SENSOR MODES Cooking Chart
- 18-19 NEW WAVE COOKBOOK
 - 18 VEGETABLES
 - 18 MEATS - POULTRY - FISH/SEAFOOD - FROZEN FOOD - PASTA/GRAINS
 - 19 NEW WAVE COOKBOOK Chart
- 20-25 MICROWAVE RECIPES AND INSTRUCTIONS
 - 20 Breakfast Bar / Lunch On The Run
 - 20 Breakfast Bar / Lunch On The Run Chart
 - 21 One Dish Dinners - Low Calorie Entrees
 - Supper Soups And Sauces - Delicious Desserts
 - 22 Recipes for One Dish Dinners
 - 23 Recipes for Low Calorie Entrees
 - 24 Recipes for Supper Soups And Sauces
 - 25 Recipes for Delicious Desserts
- 26-28 DEFROST
 - 26 Super Defrost
 - 26 Super Defrost Chart
 - 27 Auto Defrost
 - 27 Auto Defrost Chart
 - 28 Manual Defrost
- 28 BEVERAGES
- 29-30 SET UP
 - 29 1. Clock
 - 29 2. Auto Start
 - 30 3. Sound Adjustment
 - 30 4. Child Lock
 - 30 5. Video Demo
 - 30 6. Screen Contrast
- 30-32 Other Convenient Features
 - 30 Easy Minute
 - 31 Time Select
 - 31 Kitchen Timer
 - 32 More or Less Time Adjustment
- 33 Cleaning and Care
- 34 Specifications
- 34 Service Call Check
- 35-36 Quick Reference
 - 35 SENSOR MODES
 - 35 NEW WAVE COOKBOOK
 - 35 MICROWAVE RECIPES AND INSTRUCTIONS
 - 35 DEFROST
 - 35 BEVERAGES
 - 35 SET UP
- 36 Quick Reference

PRODUCT WARRANTY

WHAT IS COVERED

CERTIFICATE OF WARRANTIES

DACOR MICROWAVE OVEN

WITHIN THE FIFTY STATES OF THE U.S.A. , THE DISTRICT OF COLUMBIA AND CANADA*:

FULL ONE YEAR WARRANTY

If your DACOR product fails to function within one year of the original date of purchase, due to a defect in material or workmanship, DACOR will remedy the defect without charge to you or subsequent users. The owner must provide proof of purchase upon request and have the appliance accessible for service.

* Warranty is null and void if non-CSA approved product is transported from the U.S.

OUTSIDE THE FIFTY STATES OF THE U.S.A. , THE DISTRICT OF COLUMBIA AND CANADA:

LIMITED FIRST YEAR WARRANTY

If your DACOR product fails to function within one year of the original date of purchase, due to a defect in material or workmanship, DACOR will furnish a new part, F.O.B. factory, to replace the defective part. All delivery, installation and labor costs are the responsibility of the purchaser. The owner must provide proof of purchase upon request and have the appliance accessible for service.

WHAT IS NOT COVERED

- Failure of the product caused by faulty installation, improper usage, or neglect of required maintenance.
- Service calls to educate the customer in the proper use and care of the product.
- Failure of the product when used for commercial, business, rental or any application other than for residential consumer use.
- Replacement of house fuses or fuse boxes, or resetting of circuit breakers.
- Damage to the product caused by accident, fire, flood or other acts of God.
- Breakage, discoloration or damage to glass, metal surfaces, plastic components, trim, paint, porcelain or other cosmetic finish, caused by improper usage or care, abuse, or neglect.

THE REMEDIES PROVIDED FOR IN THE ABOVE EXPRESS WARRANTIES ARE THE SOLE AND EXCLUSIVE REMEDIES THEREFORE NO OTHER EXPRESS WARRANTIES ARE MADE, AND OUTSIDE THE FIFTY STATES OF THE UNITED STATES AND THE DISTRICT OF COLUMBIA, ALL IMPLIED WARRANTIES, INCLUDING BUT NOT LIMITED TO, ANY IMPLIED WARRANTY OF MERCHANTABILITY OR FITNESS FOR A PURCHASE. IN NO EVENT SHALL DACOR BE LIABLE FOR INCIDENTAL EXPENSE OR CONSEQUENTIAL DAMAGES NO WARRANTIES, EXPRESS OR IMPLIED, ARE MADE TO ANY BUYER FOR RESALE.

Some states do not allow limitations on how long an implied warranty lasts or do not allow the exclusion or limitation of incidental or consequential damages, so the above limitations or exclusions may not apply to you. This warranty gives you specific legal rights, and you may also have other rights that vary from state to state.

IMPORTANT SAFETY INSTRUCTIONS

When using electrical appliances, basic safety precautions should be followed, including the following:

WARNING - To reduce the risk of burns, electric shock, fire, injury to persons or exposure to excessive microwave energy:

1. **Read all instructions before using the appliance.**
2. Read and follow the specific **“PRECAUTIONS TO AVOID POSSIBLE EXPOSURE TO EXCESSIVE MICROWAVE ENERGY”** on page 2.
3. This appliance must be grounded. Connect only to properly grounded outlet. See **“GROUNDING INSTRUCTIONS”** on page 7 and **INSTALLATION INSTRUCTIONS**.
4. Install or locate this appliance only in accordance with the provided installation instructions.
5. Some products such as whole eggs and sealed containers — for example, closed glass jars — may explode and should not be heated in this oven.
6. Use this appliance only for its intended use as described in this manual. Do not use corrosive chemicals or vapors in this appliance. This type of oven is specifically designed to heat, cook or dry food. It is not designed for industrial or laboratory use.
7. As with any appliance, close supervision is necessary when used by children.
8. Do not operate this appliance if it has a damaged cord or plug, if it is not working properly or if it has been damaged or dropped.
9. This appliance should be serviced only by qualified service personnel. Contact nearest Dacor Authorized Servicer for examination, repair or adjustment.
10. Do not cover or block any openings on the appliance.
11. Do not store or use this appliance outdoors. Do not use this product near water—for example, near a kitchen sink, in a wet basement or near a swimming pool, and the like.
12. Do not immerse cord or plug in water.
13. Keep cord away from heated surfaces.
14. Do not let cord hang over edge of table or counter.
15. See door surface cleaning instructions on page 33.
16. To reduce the risk of fire in the oven cavity:
 - a. Do not overcook food. Carefully attend appliance if paper, plastic or other combustible materials are placed inside the oven to facilitate cooking.
 - b. Remove wire twist-ties from paper or plastic bags before placing bag in oven.
 - c. **If materials inside the oven should ignite, keep oven door closed, turn oven off, and disconnect the power cord or shut off power at the fuse or circuit breaker panel.**
 - d. Do not use the cavity for storage purposes. Do not leave paper products, cooking utensils or food in the cavity when not in use.
17. If the oven is installed as a built-in, observe the following instructions:
 - a. Do not mount over a sink.
 - b. Do not store anything directly on top of the appliance surface when the appliance is in operation.

SAVE THESE INSTRUCTIONS

INSTALLATION INSTRUCTIONS

Unpacking and Examining Your Oven

Remove: all packing materials from inside the oven cavity; however, **DO NOT REMOVE THE WAVEGUIDE COVER**, which is located on the right cavity wall. Read enclosures and **SAVE** the Use and Care Installation Instructions.

Check the oven for any damage, such as misaligned or bent door, damaged door seals and sealing surfaces, broken or loose door hinges and latches inside the cavity or on the door. If there is any damage, do not operate the oven and contact your dealer or **DACOR AUTHORIZED SERVICER**.

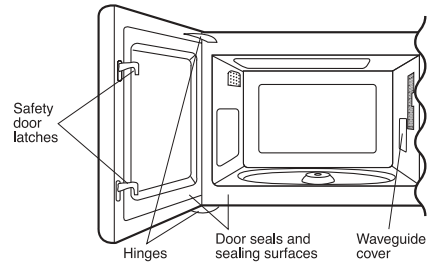

Choosing a Location for Your Oven on the counter

You will use the oven frequently so plan its location for ease of use. It's wise, if possible, to have counter space on at least one side of the oven. Allow at least 2 inches on the sides, top and at the rear of the oven for air circulation.

Choosing a Location for Your Oven if built-in

Your oven can be built into a cabinet or wall by itself or above any DACOR wall oven listed below using DACOR's Built-in Kits, either the AMTK27 or the AMTK30. The AMTK27 is for a 27" wall oven, while the AMTK30 accommodates installation above 30" wall ovens.

The applicable wall ovens and warming ovens are as follows:

OVENS - ECS127, ECS130, MCS127, MCS130, PCS127, PCS130

WARMING OVENS - EWO24, EWO27, EWO30, MWO27, MWO30, PWO24, PWO27, PWO30, IWO24, IWO27

Do not built-in above any other gas or electric wall oven.

See Built-in Kit Installation Instructions for proper location when building in above the specified wall ovens. Carefully follow both the wall oven installation instructions and Built-in Kit instructions.

The opening in the wall or cabinet must be within the following dimensions:

- A HEIGHT** : 16 ³/₄" to 17"
- B WIDTH** : 24 ³/₈" to 24 ¹¹/₁₆"
- C DEPTH** : minimum 20"

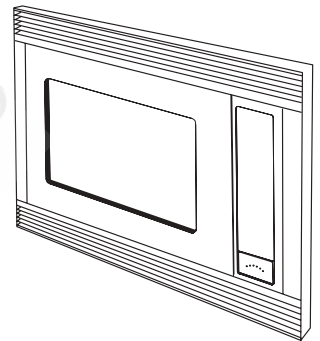

OVER OVEN INSTALLATION

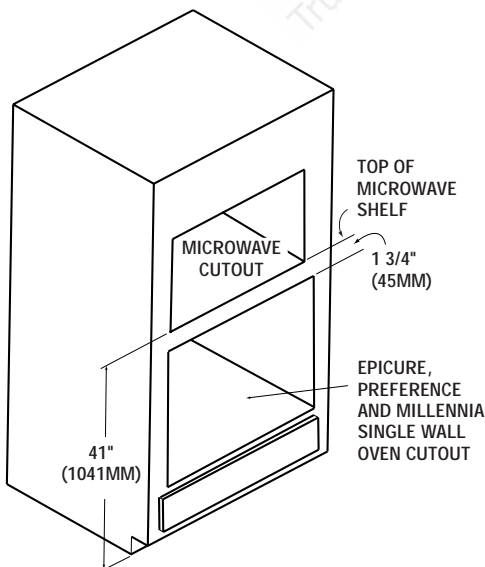

OVER WARMING OVEN INSTALLATION

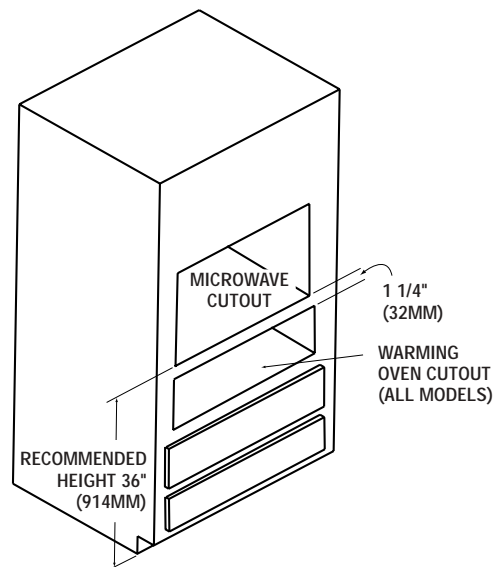

INSTALLATION INSTRUCTIONS

Outlet should NOT be in the shaded area as indicated.

1. If the dimension of DEPTH (C) is more than 21", the outlet location may be any area on the rear wall.
2. The floor of the opening should be constructed of plywood strong enough to support the weight of the oven and floor load (about 100 pounds). The floor should be level for proper operation of the oven. Be sure to check the local building code as it may require that the opening be enclosed with sides, ceiling and rear partition. The proper functioning of the oven does not require the enclosure.

Call toll-free: 1-800-793-0093 for ordering the kit to be sent to your address.

The kit includes all the necessary parts and easy-to-follow instructions for installation as well as location of the power supply. The AMTK27 (27") and AMTK30 (30") kits include simulated frames, which match the DMT2420 microwave oven.

The ease of assembly for these kits will allow installation into an existing wall opening in less than an hour (if power outlet is already properly located).

All it takes are four steps and a Phillips screw driver.

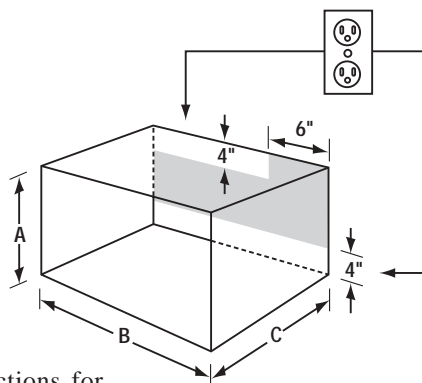

GROUNDING INSTRUCTIONS

This appliance must be grounded. This oven is equipped with a cord having a grounding wire with a grounding plug. It must be plugged into a wall receptacle that is properly installed and grounded in accordance with the National Electrical Code and local codes and ordinances. In the event of an electrical short circuit, grounding reduces risk of electric shock by providing an escape wire for the electric current.

WARNING – Improper use of the grounding plug can result in a risk of electric shock.

Electrical Requirements

The electrical requirements are a 120 volt 60 Hz, AC only, 15 amp. or more protected electrical supply. It is recommended that a separate circuit serving only this appliance be provided.

The oven is equipped with a 3-prong grounding plug. It must be plugged into a wall receptacle that is properly installed and grounded. Should you only have a 2-prong outlet, have a qualified electrician install a correct wall receptacle.

A 3-prong adapter may be purchased and used temporarily if local codes allow. Follow package directions.

A short power-supply cord is provided to reduce risk of becoming entangled in or tripping over a longer cord.

Extension Cord

If it is necessary to use an extension cord, use only a 3-wire extension cord that has a 3-blade grounding plug and a 3-slot receptacle that will accept the plug on the microwave oven. The marked rating of the extension cord should be AC 115-120 volt, 15 amp. or more.

Be careful not to drape the cord over the countertop or table where it can be pulled on by children or tripped over accidentally.

- Notes:**
1. If you have any questions about the grounding or electrical instructions, consult a qualified electrician or service person.
 2. Neither DACOR nor the dealer can accept any liability for damage to the oven or personal injury resulting from failure to observe the correct electrical connection procedures.

Radio or TV Interference

Should there be any interference caused by the microwave oven to your radio or TV, check that the microwave oven is on a different electrical circuit, relocate the radio or TV as far away from the oven as feasible or check position and signal of receiving antenna.

Permanent and Correct Installation

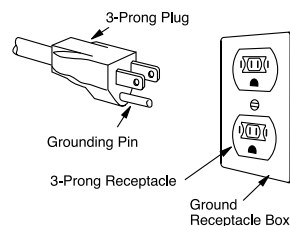

Temporary Use

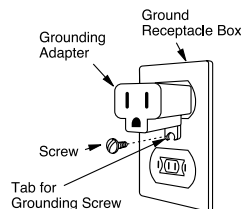

INFORMATION YOU NEED TO KNOW

ABOUT YOUR OVEN

This Operation Manual is valuable: read it carefully and always save it for reference.

A good microwave cookbook is a valuable asset. Check it for microwave cooking principles, techniques, hints and recipes.

NEVER use the oven without the turntable and support nor turn the turntable over so that a large dish could be placed in the oven. The turntable will turn both clockwise and counterclockwise.

ALWAYS have food in the oven when it is on to absorb the microwave energy.

When using the oven at power levels below 100%, you may hear the magnetron cycling on and off.

Condensation is a normal part of microwave cooking. Room humidity and the moisture in food will influence the amount of moisture that condenses in the oven. Generally, covered foods will not cause as much condensation as uncovered ones. Vents on the oven back must not be blocked.

The oven is for food preparation only. It should not be used to dry clothes or newspapers.

Your oven is rated 1200 watts by using the IEC Test Procedure. In using recipes or package directions, check food a minute or two before the minimum time and add time accordingly.

ABOUT FOOD

| FOOD | DO | DON'T |
|--|---|--|
| Eggs, sausages, nuts, seeds, fruits & vegetables | <ul style="list-style-type: none">• Puncture egg yolks before cooking to prevent “explosion”.• Pierce skins of potatoes, apples, squash, hot dogs and sausages so that steam escapes. | <ul style="list-style-type: none">• Cook eggs in shells.• Reheat whole eggs.• Dry nuts or seeds in shells. |
| Popcorn | <ul style="list-style-type: none">• Use specially bagged popcorn for the microwave oven.• Listen while popping corn for the popping to slow to 1 or 2 seconds or use special Popcorn pad. | <ul style="list-style-type: none">• Pop popcorn in regular brown bags or glass bowls.• Exceed maximum time on popcorn package. |
| Baby food | <ul style="list-style-type: none">• Transfer baby food to small dish and heat carefully, stirring often. Check temperature before serving.• Put nipples on bottles after heating and shake thoroughly. “Wrist” test before feeding. | <ul style="list-style-type: none">• Heat baby food in original jars.• Heat disposable bottles.• Heat bottles with nipples on. |
| General | <ul style="list-style-type: none">• Cut baked goods with filling after heating to release steam and avoid burns.• Stir liquids briskly before and after heating to avoid “eruption”.• Use deep bowl, when cooking liquids or cereals, to prevent boilovers. | <ul style="list-style-type: none">• Heat or cook in closed glass jars or air tight containers.• Can in the microwave as harmful bacteria may not be destroyed.• Deep fat fry.• Dry wood, gourds, herbs or wet papers.• Operate the oven empty. |

INFORMATION YOU NEED TO KNOW

ABOUT UTENSILS AND COVERINGS

It is not necessary to buy all new cookware. Many pieces already in your kitchen can be used successfully in your new microwave oven.

Use these utensils for safe microwave cooking and reheating:

- glass ceramic (Pyroceram®), such as Corningware®.
- heat-resistant glass (Pyrex®)
- microwave-safe plastics (some microwave-safe plastics are not suitable for cooking foods with high fat and sugar content.)
- paper plates
- microwave-safe pottery, stoneware and porcelain
- browning dish (Do not exceed recommended preheating time. Follow manufacturer's directions.)

These items can be used for short time reheating of foods that have little fat or sugar in them:

- wood, straw, wicker

DO NOT USE

- metal pans and bakeware
- dishes with metallic trim
- non-heat-resistant glass
- non-microwave-safe plastics (margarine tubs)
- recycled paper products
- brown paper bags
- food storage bags
- metal twist-ties

Should you wish to check if a dish is safe for microwaving, place the empty dish in the oven and microwave on 100% power for 30 seconds. A dish which becomes very hot should not be used.

ABOUT CHILDREN AND THE MICROWAVE

Children below the age of 7 should use the microwave oven with a supervising person very near to them. Between the ages of 7 and 12, the supervising person should be in the same room.

The child must be able to reach the oven comfortably; if not, he/she should stand on a sturdy stool.

At no time should anyone be allowed to lean or swing on the oven door.

The following coverings are ideal:

- Paper towels are good for covering foods for reheating and absorbing fat while cooking bacon.
- Wax paper can be used for cooking and reheating.
- Plastic wrap that is specially marked for microwave use can be used for cooking and reheating. **DO NOT** allow plastic wrap to touch food. Vent so steam can escape.
- Lids that are microwave-safe are a good choice because heat is kept near the food to hasten cooking.
- Oven cooking bags are good for large meats or foods that need tenderizing. **DO NOT** use metal twist ties. Remember to slit bag so steam can escape.

How to use aluminum foil in your microwave oven:

- Small flat pieces of aluminum foil placed smoothly on the food can be used to shield areas that are either defrosting or cooking too quickly.
- Foil should not come closer than one inch to any surface of the oven.

Should you have questions about utensils or coverings, check a good microwave cookbook or follow recipe suggestions.

ACCESSORIES There are many microwave accessories available for purchase. Evaluate carefully before you purchase so that they meet your needs. A microwave-safe thermometer will assist you in determining correct doneness and assure you that foods have been cooked to safe temperatures. Dacor is not responsible for any damage to the oven when accessories are used.

Children should be taught all safety precautions: use potholders, remove coverings carefully, pay special attention to packages that crisp food because they may be extra hot.

Don't assume that because a child has mastered one cooking skill he/she can cook everything.

Children need to learn that the microwave oven is not a toy. See page 30 for Child Lock feature.

INFORMATION YOU NEED TO KNOW

ABOUT MICROWAVE COOKING

- Arrange food carefully. Place thickest areas toward outside of dish.
- Watch cooking time. Cook for the shortest amount of time indicated and add more as needed. Foods severely overcooked can smoke or ignite.
- Cover foods while cooking. Check recipe or cookbook for suggestions: paper towels, wax paper, microwave plastic wrap or a lid. Covers prevent splattering and help foods to cook evenly.
- Shield with small flat pieces of aluminum foil any thin areas of meats or poultry to prevent overcooking before dense, thick areas are cooked thoroughly.
- Stir foods from outside to center of dish once or twice during cooking, if possible.
- Turn foods over once during microwaving to speed cooking of such foods as chicken and hamburgers. Large items like roasts must be turned over at least once.
- Rearrange foods like meatballs halfway through cooking both from top to bottom and from the center of the dish to the outside.
- Add standing time. Remove food from oven and stir, if possible. Cover for standing time which allows the food to finish cooking without overcooking.
- Check for doneness. Look for signs indicating that cooking temperatures have been reached.

Doneness signs include:

- Food steams throughout, not just at edge.
- Center bottom of dish is very hot to the touch.
- Poultry thigh joints move easily.
- Meats and poultry show no pinkness.
- Fish is opaque and flakes easily with a fork.

ABOUT SAFETY

- Check foods to see that they are cooked to the United States Department of Agriculture's recommended temperatures:
- Always use potholders to prevent burns when handling utensils that are in contact with hot food. Enough heat from the food can transfer through utensils to cause skin burns.
- Avoid steam burns by directing steam away from the face and hands. Slowly lift the farthest edge of a dish's covering and carefully open popcorn and oven cooking bags away from the face.
- Stay near the oven while it's in use and check cooking progress frequently so that there is no chance of overcooking food.
- NEVER use the cavity for storing cookbooks or other items.
- Select, store and handle food carefully to preserve its high quality and minimize the spread of foodborne bacteria.
- Keep waveguide cover clean. Food residue can cause arcing and/or fires.
- Use care when removing items from the oven so that the utensil, your clothes or accessories do not touch the safety door latches.

| TEMP | FOOD |
|-------|--|
| 160°F | ... for fresh pork, ground meat, boneless white poultry, fish, seafood, egg dishes and frozen prepared food. |
| 165°F | ... for leftover, ready-to-reheat refrigerated, and deli and carry-out "fresh" food. |
| 170°F | ... white meat of poultry. |
| 180°F | ... dark meat of poultry. |

To test for doneness, insert a meat thermometer in a thick or dense area away from fat or bone. NEVER leave the thermometer in food during cooking, unless it is approved for microwave oven use.

PART NAMES

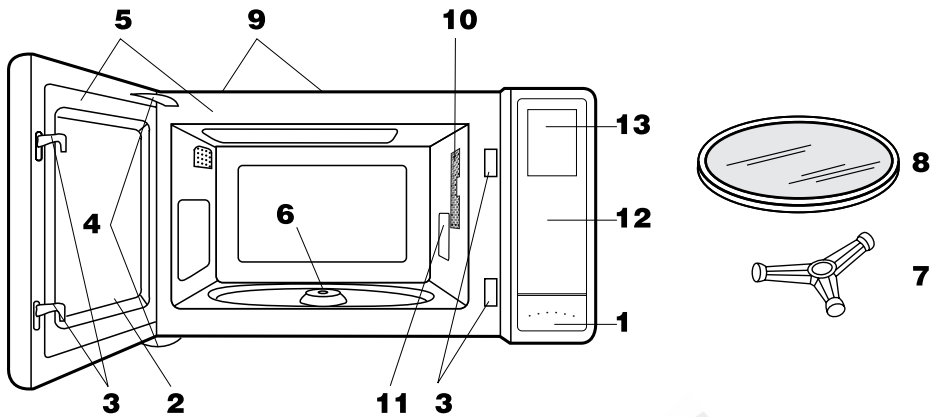

- 1 One touch door open button Push to open door.
- 2 Oven door with see-through window
- 3 Safety door latches
The oven will not operate unless the door is securely closed.
- 4 Door hinges
- 5 Door seals and sealing surfaces
- 6 Turntable motor shaft
- 7 Removable turntable support
Carefully place the turntable support in the center of the oven floor.
- 8 Removable turntable
Place the turntable on the turntable support securely. The turntable will rotate clockwise or counterclockwise. Only remove for cleaning.
- 9 Ventilation openings (Rear)
- 10 Oven light
It will light when oven is operating or door is open.
- 11 Waveguide cover: DO NOT REMOVE.
- 12 Control panel
- 13 Touch Screen

CONTROL PANEL

NEW WAVE TOUCH SCREEN : 13-14

The Home Page is for entering time for cooking or kitchen timer. The TOUCH SCREEN shows cooking information and recipes and lets the user enter chosen options by simply touching directly on the screen.

Time Select : 31

Touch to access screen where 12 common cooking times are shown that simply require one touch to start.

STOP/CLEAR : 15

During programming, press once to return to the Home Page. During cooking, press once to stop cooking or twice to cancel the cooking program.

EASY MINUTE : 30

Press once to cook for one minute at 100% or press repeatedly to extend cooking time in multiples of one minute.

NEW WAVE COOKBOOK : 18-19

Press each pad to show six selections on the TOUCH SCREEN.

DEFROST : 26-27

Press to select one of three Super Defrost or one of six Auto Defrost options.

BEVERAGES : 28

Press to prepare or reheat coffee or tea.

Kitchen Timer : 31

Touch Kitchen Timer, enter desired time and press START.

START

Press to start oven after programming.

SENSOR MODES : 17

Select pad to bake potatoes, pop popcorn or reheat previously prepared foods.

MICROWAVE RECIPES AND INSTRUCTIONS : 20-25

Press pad to show six categories, each with six foods. Breakfast Bar, Lunch on the Run, One Dish Dinners, Low Calorie Entrees, Supper Soups and Sauces and Delicious Desserts are the options.

SET UP : 29-30

Press to show Clock, Child Lock, Sound Adjustment, Auto Start, Video Demo or Screen Contrast.

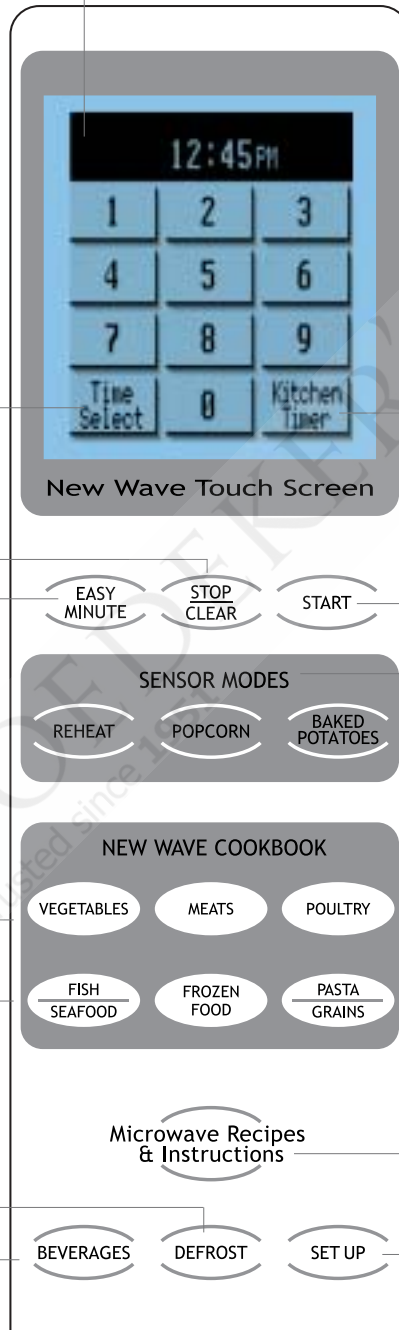

INTRODUCTION TO TOUCH SCREEN

Your new Microwave Oven features a large screen on the Control Panel which, not only provides much information to make using the oven easy, but also, is used to input information directly about the food being cooked, quantity or desired doneness.

Example 1: Home Page



The Home Page is the beginning. It shows the time of day, if the clock has been set. It also shows Time Select, where by touching the screen the next screen appears, making it easy to select one of twelve commonly used times. Touching Kitchen Timer tells the oven that the time set is only for timing, not for cooking.

Note that if cooking time is touched on the screen, that Time Select and Kitchen Timer disappear and Power Level appears. Touching Power Level leads to the next screen for selecting the desired Power Level.

Example 2: Suppose you want to cook meat loaf in NEW WAVE COOKBOOK:

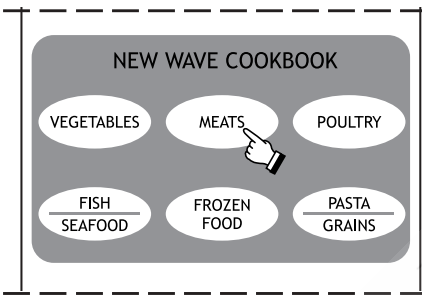

1 Press MEATS on the Control Panel in NEW WAVE COOKBOOK.



2 Note that six meat selections appear on the TOUCH SCREEN. Touch Meat Loaf.



3 Follow directions on the TOUCH SCREEN.

Example 3: Suppose you want to cook Spicy Couscous in MICROWAVE RECIPES AND INSTRUCTIONS:

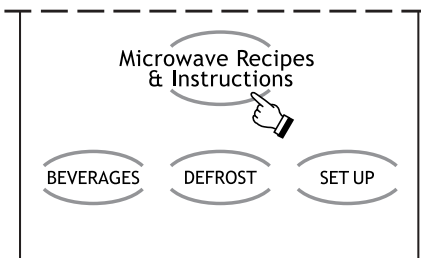

1 Press Microwave Recipes & Instructions on the Control Panel.



2 Touch One Dish Dinners on the TOUCH SCREEN.

INTRODUCTION TO TOUCH SCREEN



3 Touch Spicy Couscous.

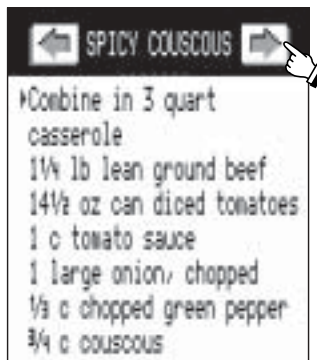

4 Note Preparation steps. Note arrows*.

* Forward  and Back  Arrows:

On all recipe screens and some preparation screens, there will be forward and back arrows, located in the upper corners of the TOUCH SCREEN. Touch to read the entire recipe before beginning any cooking.

BEFORE OPERATING

Before operating your microwave oven, be sure to read and understand this operation manual.

Before the oven can be used, follow the steps:

1. Plug in the oven. Close the door. You can select either: Video Demo or Set Clock.
2. Touch Set Clock and follow the instructions below.

NOTE:

If no choice is made for 30 seconds, the Video Demo will begin automatically. To cancel the Video Demo, press the STOP/CLEAR pad and the display will return to the Home Page. To set the clock, press the Set Up pad, touch Clock and follow the directions on the Touch Screen.

TO SET THE CLOCK

- Suppose you want to enter the correct time of day: 12:30 PM.

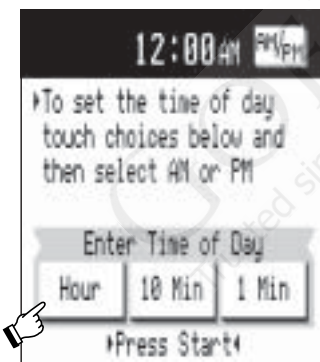

1 After touching Set Clock, enter the time of day (hour) by touching Hour 11 times.

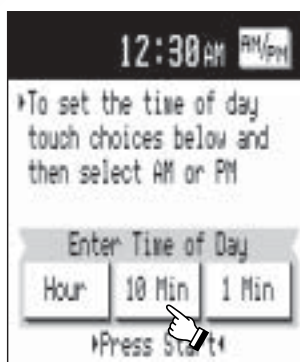

2 Enter the time of day (minutes) by touching 10 Min. 3 times.

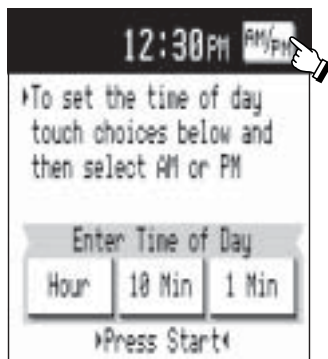

3 Select AM or PM and then press the START pad.



4 The clock will start. The display will return to the Home Page.

BEFORE OPERATING

NOTE :

1. If you make a mistake while setting the clock, touch STOP/CLEAR pad. The Home Page will appear. To set clock again, press Set Up pad on the control panel and Clock. Keep touching the screen until the desired time of day appears.
2. If you want to change the setting of the time of day, press Set Up pad and follow the directions.
3. If the electrical power supply to your microwave oven should be interrupted, the screen will intermittently show Video Demo or Set Clock after the power is reinstated. If this occurs during cooking, the program will be erased. Simply touch Set Clock and follow the directions.
4. If you touch continuously the Hour, 10 Min or 1 Min on the Touch Screen, the time will count up automatically.

STOP/CLEAR

Touch the STOP/CLEAR pad to:

1. Return the Home Page to the display, if you make a mistake during programming.
2. Stop the oven temporarily during cooking.
3. Cancel Kitchen Timer/Auto Start.
4. Cancel a program during cooking, touch twice.

MANUAL OPERATION

TIME COOKING

Your oven can be programmed for 99 minutes and 99 seconds (99.99). Always enter the seconds after the minutes, even if they are both zeros.

HIGH POWER COOKING

- Suppose you want to cook for five minutes at 100% power:

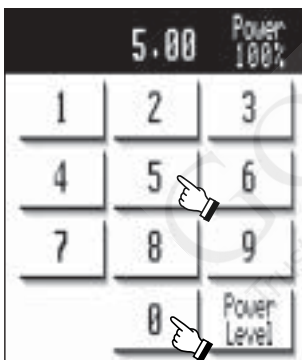

- 1 Enter cooking time, 5, 0, 0 by touching numbers. Note the top line of the display. Press the START pad.

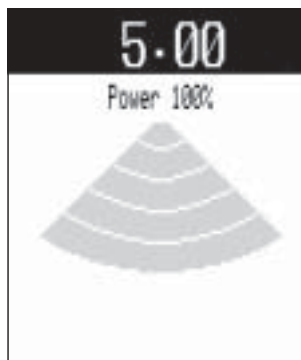

- 2 The display will begin counting down the cooking time. During the cooking, the power level will appear in the display.

NOTE:

If the door is opened or STOP/CLEAR pad is pressed once during cooking process, the cooking time in the display automatically stops. The cooking time starts

to count down again when the door is closed and the START pad is pressed.

MANUAL OPERATION

VARIABLE POWER COOKING

There are eleven preset power levels. To change the power level, touch Power Level after entering the cooking time. Using lower power levels increases the cooking time which is recommended for foods such as cheese, milk and long slow cooking of meats. Consult cookbook or recipes for specific recommendations.

- Suppose you want to cook for 5 minutes at 30% power:

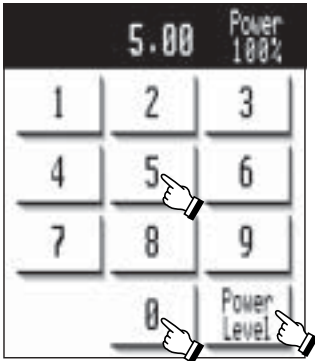

- 1 Enter cooking time, 5, 0, 0 by touching numbers. Touch Power Level.

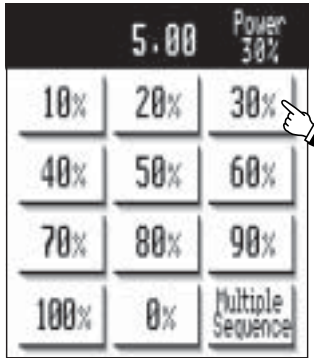

- 2 Touch 30%. The top line of the display will show time and chosen power level. Press START pad.

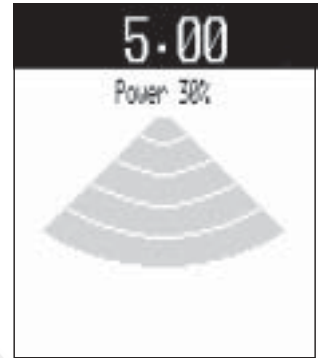

- 3 The display will begin counting down the cooking time. During the cooking, the power level will appear in the display.

MULTIPLE SEQUENCE COOKING

The oven can be programmed for up to four automatic cooking sequences, switching from one power level setting to another automatically. Sometimes cooking directions tell you to start on one power level and then change to a different power level. Your oven can do this automatically.

- Suppose you want to cook roast beef for 5 minutes at 70% power and then continue to cook for 30 minutes at 50% power:

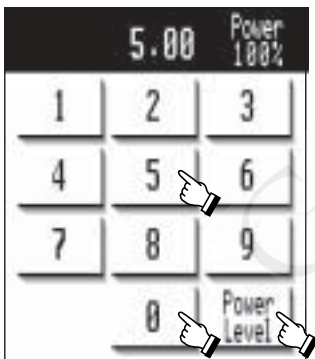

- 1 Enter cooking time, 5, 0, 0 by touching numbers. Touch Power Level.

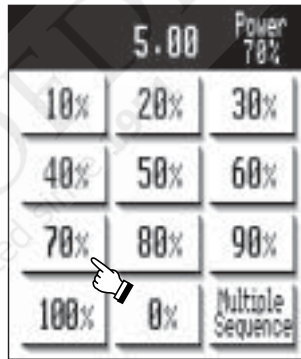

- 2 Touch 70%. You can omit this step when you set 100% power.

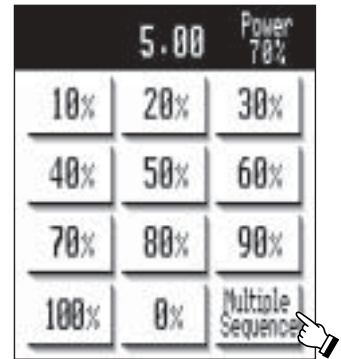

- 3 Touch Multiple Sequence.

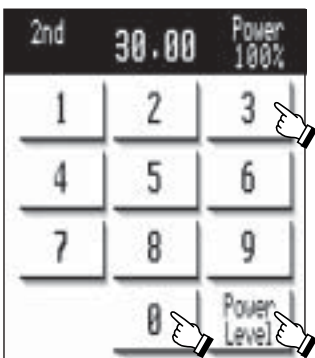

- 4 Touch second cooking time 3, 0, 0, 0. Touch Power Level.

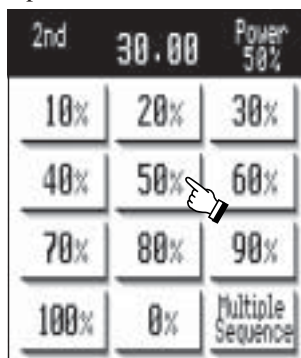

- 5 Touch 50%. Then press the START pad.

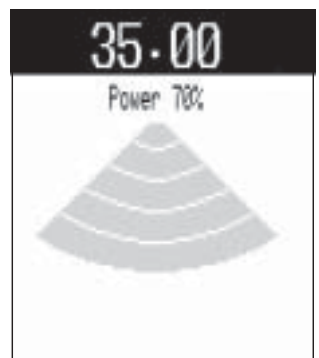

- 6 The display will begin counting down the total cooking time. During the cooking, the power level will appear in the display.

SENSOR MODES

The Sensor is a semi-conductor device that detects the vapor (moisture and humidity) emitted from the food as it heats. The sensor adjusts the cooking times and power level for various foods and quantities.

Using Sensor Settings

1. After oven is plugged in, wait two minutes before using any Sensor setting.
2. Be sure the exterior of the cooking container and the interior of the oven are dry. Wipe off any moisture with a dry cloth or paper towel.
3. The oven works with foods at normal storage temperature. For example, popcorn would be at room temperature.
4. Any Sensor Cooking or Reheating selection can be programmed with More or Less Time Adjustment. See page 32.
5. More or less food than the quantity listed in the chart should be cooked following the guidelines in any microwave cookbook.
6. During the first part of Sensor Cooking or Reheating, SENSING will appear on the display. Do not open the oven door or press STOP/CLEAR pad during this part of the cooking cycle. The measurement of vapor will be interrupted. If this occurs, an error message will appear. To continue cooking, touch the STOP/CLEAR pad and cook manually.
When the sensor detects the vapor emitted from the food, remainder of cooking or reheating time will appear. The door may be opened when remaining cooking time appears on the display. At this time, you may stir or season food, as desired.
7. If the sensor does not detect vapor properly when cooking or reheating foods, error messages will be displayed, and the oven will turn off.
8. Check food for correct temperature after cooking. If additional time is needed, continue to cook manually.

SENSOR MODES COOKING CHART

| FOOD | AMOUNT | PROCEDURE |
|----------------|-----------------------|---|
| REHEAT | 4 - 36 oz | Place in dish or casserole slightly larger than amount to be reheated. Flatten, if possible. Cover with lid, plastic wrap or wax paper. Use covers such as plastic wrap or lids with larger quantities of more dense foods such as stews. After reheating, stir well, if possible. Re-cover and allow to stand 2 to 3 minutes. Foods should be very hot. If not, continue to heat with variable power and time. |
| POPCORN | 1 pkg 1.5 - 3.5 oz | Use only popcorn packaged for microwave oven use. Try several brands to decide which you like the best. Do not try to pop unpopped kernels. |
| BAKED POTATOES | 1 - 8 | Pierce. Place on paper-towel-lined turntable. After cooking, remove from oven, wrap in aluminum foil and let stand 5 to 10 minutes. |

Covering Foods

Some foods work best when covered. Use the cover recommended in the procedure for these foods.

1. Casserole lid.
 2. Plastic wrap: Use plastic wrap recommended for microwave cooking. Cover dish loosely; allow approximately 1/2 inch to remain uncovered to allow steam to escape. Plastic wrap should not touch food.
 3. Wax paper: Cover dish completely; fold excess wrap under dish to secure. If dish is wider than paper, overlap two pieces at least one inch to cover.
- Be careful when removing any covering to allow steam to escape away from you.

REHEAT - POPCORN - BAKED POTATOES

You can cook or reheat many foods by pressing just one pad. You don't need to calculate cooking time or power level.

- Suppose you want to cook two baked potatoes:



Press BAKED POTATOES pad and the oven will start automatically.

When the sensor detects the vapor emitted from the food, remainder of cooking time will appear, during which the oven door can be opened to add ingredients or check foods.

NOTE:

1. After pressing any SENSOR MODES pad, cooking hints will appear for about 7 seconds, during which the door may be opened or STOP/CLEAR pressed. To restart the oven, close the door and press the START pad.
2. All SENSOR MODES pads can be pressed within 3 minutes after cooking, opening and closing the door or pressing the STOP/CLEAR pad.

NEW WAVE COOKBOOK

Your oven has six food pads and each pad has six selections. Many sensor cooked foods are included in NEW WAVE COOKBOOK. See the sensor cooking information on page 17. For foods not using the sensor, follow the directions on the Touch Screen

to enter quantity. When cooking foods with the sensor, it is not necessary to enter quantity or weight. The foods using the sensor are indicated with “*” in the chart on page 19.

VEGETABLES

The desired doneness can be selected for any vegetables choice.

- Suppose you want to cook broccoli (normal):

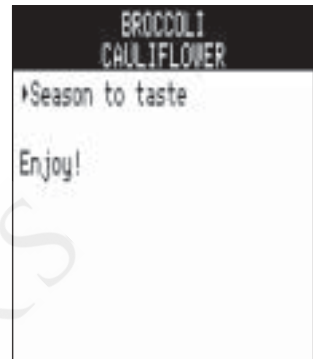
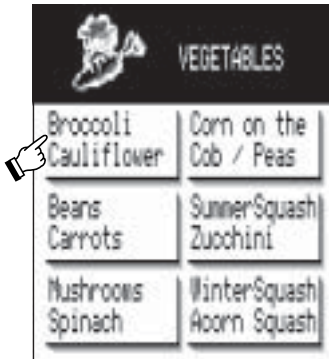

- 1 Press the VEGETABLES pad and then touch the desired vegetable: Broccoli.
- 2 Touch the desired doneness, and the oven will start automatically. When the sensor detects the vapor emitted from the food, remaining cooking time will appear. The oven door can be opened whenever the count down time is displayed on the Touch Screen.
- 3 After cooking, follow instructions.

NOTE:

You can also start the cooking by pressing the START pad at step 2. At that time “normal” is selected automatically. The doneness can be changed after pressing the START pad by touching the desired doneness on the display within seven seconds.

MEATS - POULTRY - FISH/SEAFOOD FROZEN FOODS - PASTA/GRAINS

- Suppose you want to cook 2.0 lb boneless pork loin:



- 1 Press MEATS pad and then touch the desired meat: Boneless Pork Loin.
- 2 Enter desired weight by touching the screen. Then press the START pad.
- 3 After cooking, follow instructions.

NEW WAVE COOKBOOK

NEW WAVE COOKBOOK COOKING CHART

| FOOD | AMOUNT |
|----------------------------------|--------------|
| VEGETABLES | |
| BROCCOLI / CAULIFLOWER* | .25 - 2.0 lb |
| BEANS / CARROTS* | .25 - 1.5 lb |
| MUSHROOMS / SPINACH* | .25 - 2.0 lb |
| CORN ON THE COB / PEAS* | .25 - 1.5 lb |
| SUMMER SQUASH / ZUCCHINI* | .25 - 2.0 lb |
| WINTER SQUASH / ACORN SQUASH* | .25 - 2.0 lb |

| MEATS | |
|--------------------|--------------|
| GROUND BEEF* | .25 - 2.0 lb |
| BONELESS PORK LOIN | 2.0 - 3.5 lb |
| MEAT LOAF | 1.0 - 2.0 lb |
| POT ROAST | 2.0 - 3.5 lb |
| STEW | 1.0 - 2.0 lb |
| SPARERIBS | 1.0 - 3.0 lb |

| POULTRY | |
|------------------------------|--------------|
| BONELESS CHICKEN BREASTS* | .5 - 2.0 lb |
| BONE-IN CHICKEN PIECES* | .5 - 3.0 lb |
| WHOLE CHICKEN | 2.5 - 6.0 lb |
| TURKEY BREAST | 3.0 - 6.0 lb |
| TURKEY DRUMSTICK | 1.0 - 3.0 lb |
| GROUND POULTRY* | .25 - 2.0 lb |

| FOOD | AMOUNT |
|-----------------------------|-------------------|
| FISH / SEAFOOD | |
| FISH FILLETS* | .25 - 2.0 lb |
| FISH STEAKS* | .25 - 2.0 lb |
| SHRIMP* | .25 - 2.0 lb |
| SCALLOPS* | .25 - 2.0 lb |
| CLAMS & MUSSELS* | up to 1 1/2 dozen |
| FISH KABOBS* weight of fish | .25 - 1.5 lb |

| FROZEN FOOD | |
|------------------------|-----------------------------|
| VEGETABLES* | .25 - 1.25 lb |
| ENTREES* | 6 - 17 oz |
| MAIN DISHES* | 24 - 40 oz |
| SNACKS* | 3 - 8 oz |
| SOFTEN ICE CREAM | Pint, Quart, Half Gallon |
| THAW JUICE CONCENTRATE | 6, 12, 16 oz |

| PASTA / GRAINS | |
|----------------|---------------|
| WHITE RICE* | .5 - 2.0 cups |
| BROWN RICE* | .5 - 2.0 cups |
| FRESH PASTA | 8 - 9 oz |
| DRY PASTA | 2 - 8 oz |
| GRITS | .3 - 2.0 cups |
| COUSCOUS | .5 - 2.0 cups |

NOTE:

1. You can enter the amount only within the range of the NEW WAVE COOKBOOK COOKING CHART.

* It is not necessary to enter quantity with these foods because they are cooked by the sensor.

2. NEW WAVE COOKBOOK can be programmed with More or Less Time Adjustment. See page 32.

MICROWAVE RECIPES AND INSTRUCTIONS

Microwave Recipes and Instructions has six cooking categories to assist with meal preparation. There are some foods in the Breakfast Bar and Lunch on the Run

Run that use the sensor. See sensor cooking information on page 17. For foods not using the sensor, follow the directions on the screen to enter quantity.

BREAKFAST BAR - LUNCH ON THE RUN

- Suppose you want to use Breakfast Bar to cook two servings of hot cereal.

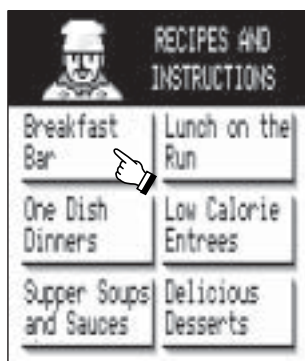

1 Press Microwave Recipes & Instructions pad and then touch the desired category: Breakfast Bar.

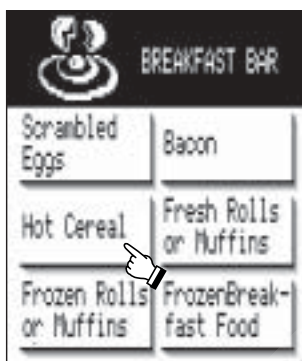

2 Select the desired food: Hot Cereal.

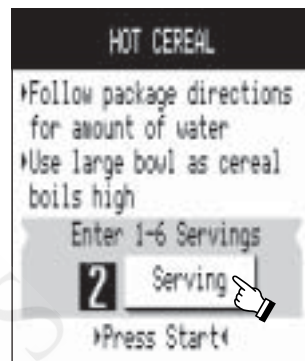

3 Enter desired quantity by touching the screen. Then press START pad. When the oven stops, follow instructions.

BREAKFAST BAR CHART

| FOOD | AMOUNT |
|-------------------------|----------------|
| Scrambled Eggs | 1 - 9 eggs |
| Bacon* | 2 - 6 slices |
| Hot Cereal | 1 - 6 servings |
| Fresh Rolls or Muffins | 1 - 10 |
| Frozen Rolls or Muffins | 1 - 10 |
| Frozen Breakfast Food* | 1 (3 - 6 oz) |

* It is not necessary to enter quantity with these foods because they are cooked by the sensor.

LUNCH ON THE RUN CHART

| FOOD | AMOUNT |
|-------------------|------------------|
| Meal in a Cup* | 1 cup (6 - 8 oz) |
| Hot Dogs in Buns* | 1 - 4 |
| Soup* | 1 - 8 cups |
| Microwave Pizza* | 1 (6 - 8 oz) |
| Pizza Reheat** | 1 - 6 slices |
| Frozen Sandwich* | 1 (3 - 6 oz) |

** Must enter number of slices on Touch Screen. Other foods in chart do not require quantity input. See Touch Screen for directions.

NOTE:

1. You can program with More or Less Time Adjustment. See page 32.
2. More or less than the quantity listed in the chart should be cooked following the guidelines in any microwave book.
3. The final cooking result will vary according to the food condition (e.g. initial temperature, shape, quality, covering). Check food for correct temperature after cooking. If additional time is needed, continue to cook manually.

MICROWAVE RECIPES AND INSTRUCTIONS

ONE DISH DINNERS - LOW CALORIE ENTREES - SUPPER SOUPS AND SAUCES - DELICIOUS DESSERTS

- Suppose you want to use One Dish Dinners to cook Spicy Couscous.

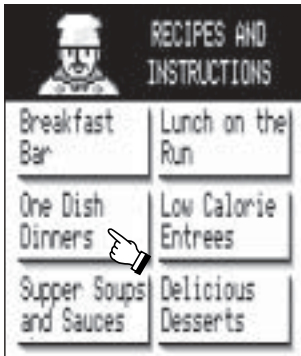

- 1 Press Microwave Recipes & Instructions pad and then touch the desired category: One Dish Dinners.



- 2 Select the desired food: Spicy Couscous.

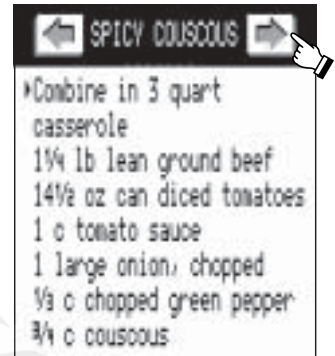

- 3 All ingredients for the recipe and step-by step procedures are shown. Touch the arrow marks on the screen to read the recipe through before cooking. The forward and back arrows allow one to check all steps BEFORE beginning any cooking.



- 4 When ready to cook, press START pad. The oven has the cooking instructions in it so it is not necessary for you to make any decisions!



- 5 When the oven stops, read the instructions on the Touch Screen, open the door, complete the steps and close door. Press START pad.



- 6 After cooking, follow instructions.

MICROWAVE RECIPES AND INSTRUCTIONS

RECIPES FOR ONE DISH DINNERS

(Recipes serve 6)

Spicy Couscous

- 1¹/₄ lb lean ground beef
 - 14¹/₂ oz can diced tomatoes
 - 1 c tomato sauce
 - 1 large onion, chopped
 - 1¹/₃ c chopped green pepper
 - 3³/₄ c couscous
 - 1 clove garlic, minced
 - 1¹/₂ tbsp chili powder
 - 1 tsp ground cumin
 - 1 tsp dried oregano leaves
 - 1 c raisins
- Garnish: yogurt and chopped fresh parsley

Salsa Chicken

- 1¹/₄ oz dry taco seasoning
- 1 lb boneless chicken breast thin strips
- 6 oz pkg yellow rice mix with seasoning packet
- 2¹/₂ c hot water
- 2¹/₂ c frozen peas
- 1 c canned corn
- 1¹/₂ c apricot preserves
- 14¹/₂ oz can diced tomatoes

Seafood Pasta

- 8 - 9 oz fresh tortellini
 - 2 c water
 - 1³/₄ c creamy Alfredo sauce
 - 1¹/₄ lb raw shellfish like shrimp, scallops, crab
 - 3 c thinly sliced fresh vegetables like carrots, mushrooms, green beans
- Garnish: 1¹/₃ c grated Parmesan cheese

Beef Burgundy

- 1¹/₂ lb 3³/₄-inch beef rump or chuck cubes
- 3 tbsp flour
- 2 slices of bacon, minced
- 1 large onion, chopped
- 3 cloves garlic, minced
- 2¹/₂ c carrots
- 1 tsp salt
- 1¹/₂ tsp pepper
- 1 tsp thyme
- 2 tsp rosemary
- 1 c red wine
- 1 c beef bouillon
- 2 c sliced mushrooms
- 2 c pearl onions

Sweet & Sour Pork

- 1 c long grain rice
 - 2 c pineapple juice
 - 1¹/₂ c water
 - 1¹/₄ c sweet & sour sauce
 - 2 tbsp soy sauce
 - 1 tbsp minced fresh ginger
 - 1¹/₄ c honey
 - 1¹/₄ lb boneless pork loin, cut into thin strips
 - 20 oz can pineapple chunks, drained
 - 3 c fresh or frozen stir-fry vegetables
- Garnish: toasted sliced almonds

Vegetarian Orzo

- 1 c orzo
 - 3¹/₂ c vegetable bouillon
 - 1¹/₄ c pesto sauce
 - 1¹/₂ c small pieces of sundried tomatoes
 - 1 tbsp minced garlic
 - 1 tbsp Italian seasoning
 - 3 c chopped green, red, orange & yellow peppers
 - 1 large onion, thinly sliced
 - 14 oz can artichoke hearts, drain & quarter
 - 3 oz pitted ripe olives, cut in half
- Garnish:
- 1¹/₂ c Parmesan cheese, freshly grated
 - 1¹/₄ c pinenuts

MICROWAVE RECIPES AND INSTRUCTIONS

RECIPES FOR LOW CALORIE ENTREES

(Recipes serve 6)

Stuffed Acorn Squash

- 3 acorn squash each weighing $\frac{3}{4}$ lb
- $1\frac{1}{4}$ lb ground turkey
- $\frac{1}{2}$ onion, chopped
- 2 carrots, shredded
- 1 green pepper, chopped
- 1 tbspcatsup
- $\frac{1}{2}$ tsp salt
- $\frac{1}{4}$ tsp pepper
- $\frac{1}{2}$ c instant rice
- 20 oz can crushed pineapple, drained
save juice
- $\frac{1}{2}$ c teriyaki sauce
- $\frac{1}{4}$ c sweet and sour sauce

Thai Chicken Kabobs

- 2 tbsplime juice
- 1 tsp cooking oil
- 1 tsp soy sauce
- $\frac{1}{8}$ tsp red pepper
- $1\frac{1}{4}$ lb boneless chicken, cut into 1-inch cubes
- 4 onions, quartered
- 2 red peppers, cut into 1-inch squares
- 2 tsp light peanut butter

Salmon Romanoff

- 12 oz dry egg noodles
- 2 c skim milk
- 1 c water
- 1 pint fat free sour cream
- $1\frac{1}{2}$ oz package dry ranch salad dressing mix
- 15 oz can salmon, drained and flaked
- 8 oz can sliced mushrooms, drained
- $\frac{1}{3}$ c chopped green onions
- 1 tsp dill weed

Steak Fajitas

- 1 lb beef flank steak, cut in diagonal inch
strips
- $\frac{1}{2}$ c orange juice
- 3 tbsplime juice
- 2 tbsp minced garlic
- 1 tbsp Worcestershire sauce
- $1\frac{1}{2}$ tbspchili powder
- 1 tsp cumin
- 2 c red, green and yellow pepper strips
- 1 large onion, chopped
- 1 c black beans, rinsed and drained
- 6 10-inch warm flour tortillas
- 1 large tomato, chopped
- $\frac{1}{2}$ c salsa
- $\frac{1}{2}$ c fat free sour cream

Glazed Roast Pork Tenderloin

- $1\frac{1}{2}$ lb whole pork tenderloin
 - 2 tsp rosemary, salt and pepper
 - $1\frac{1}{4}$ lb sweet potatoes, 2-inch cubes
 - 1 orange, thinly sliced
- Glaze:
- 8 oz whole cranberry sauce
 - $\frac{1}{2}$ c red wine
 - 2 tbsp steak sauce
 - 3 tbsp flour

Ratatouille

- $\frac{1}{4}$ c olive oil
- 1 medium eggplant, peeled and cut in 1-inch
cubes
- 1 large onion, sliced thinly
- 4 small new potatoes, cut in $\frac{3}{4}$ -inch cubes
- 1 clove garlic, minced
- 1 zucchini, sliced thinly
- 1 green pepper, cut into thin strips
- 2 c sliced fresh mushrooms
- $14\frac{1}{2}$ oz can seasoned, diced tomatoes
- $1\frac{1}{2}$ tsp dried basil
- $1\frac{1}{2}$ tsp marjoram leaves
- salt and pepper to taste

MICROWAVE RECIPES AND INSTRUCTIONS

RECIPES FOR SUPPER SOUPS AND SAUCES

(Recipes serve 6)

Chicken Noodle

- 1 tsp oil
- 1 medium onion, sliced thinly
- 1 c thin sliced celery
- 2 c thin sliced carrots
- 5 c chicken broth
- 1 1/2 lb bone-in chicken pieces
- 1 c fine egg noodles
- 1/2 c chopped parsley
- salt and pepper

Curried Vegetable

- 2 tbs oil
- 2 c 1/2-inch sweet potato cubes
- 2 c 1/2-inch white potato cubes
- 1 medium zucchini, cut into 1-inch cubes
- 1 medium red pepper, cut into 1/2-inch cubes
- 1 medium green pepper, cut into 1/2-inch cubes
- 1 medium onion, cut into 1/2-inch cubes
- 2 tbs curry powder
- 1 tsp ground cumin
- 15 oz can garbanzo beans, rinsed and drained
- 1 1/2 oz can diced tomatoes
- 15 oz can crushed tomatoes
- 1 tsp salt
- 4 c vegetable or chicken broth

Meat Sauce

- 1 lb ground beef
- 1/2 lb sweet Italian sausage
- 8 oz chopped, canned mushrooms, drained
- 1 medium onion, minced
- 2 cloves garlic, minced
- 1 stalk celery, minced
- 1 carrot, minced
- 1/2 c red wine
- 1/2 c water
- 28 oz can tomato puree
- 6 oz can tomato paste
- 1 tsp sugar
- 1 tsp dried basil
- 1 tsp oregano
- 1/4 tsp crushed red pepper
- 1 tsp salt
- 1/4 tsp pepper

Bouillabaisse

- 2 tbs olive oil
- 2 large onions, chopped finely
- 3 cloves garlic, minced
- 8 oz bottle clam juice
- 2 1/2 c dry white wine
- 1 1/2 oz can diced tomatoes
- 2 1/2 c finely chopped fennel
- 3/4 c instant rice
- 3 tbs chopped parsley
- 1 bay leaf
- 1 tsp dried thyme
- 1/2 tsp ground pepper
- 8 oz boneless white fish, cut into 4 pieces
- 8 oz scallops
- 8 oz shrimp, peeled and deveined

Split Pea

- 3 c water
- 3 c vegetable bouillon
- 1 c dried split peas
- 1/2 c chopped onion
- 1 clove garlic, minced
- 1/2 tsp dried marjoram
- 1/2 tsp dried thyme leaves
- 1 bay leaf
- 1/8 tsp cayenne pepper
- 1 c sliced carrots
- 1 c diced potatoes
- 1/2 c sliced celery

Vegetarian Chili

- 1 c sliced carrots
- 1 c sliced celery
- 1/2 c chopped red pepper
- 1/2 c chopped green pepper
- 1/2 c sliced green beans
- 1 large onion, minced
- 2 cloves garlic, minced
- 28 oz can crushed tomatoes
- 19 oz can kidney beans, rinsed and drained
- 19 oz can black beans, rinsed and drained
- 1 1/2 c water
- 1/2 c barley
- 2 tbs chili powder
- 1 tsp cumin
- 2 tsp Italian seasoning
- 1 tsp salt
- 1/4 tsp pepper

Garnish: Parmesan cheese or sour cream

MICROWAVE RECIPES AND INSTRUCTIONS

RECIPES FOR DELICIOUS DESSERTS

(Recipes serve 6)

Almond Bread Pudding

- 2 c half and half
- 2 tbsp unsalted butter, melted
- 2 large eggs, beaten
- $\frac{3}{4}$ c sugar
- 1 tsp almond extract
- $\frac{1}{2}$ c golden raisins
- $\frac{1}{2}$ c slivered, blanched almonds, toasted
- 6 c 2-inch cubed French or Challah bread

Sauce:

- $\frac{1}{4}$ c unsalted butter, melted
- $\frac{1}{2}$ c sifted confectioners' sugar
- 1 large egg
- 2 tbsp bourbon

Chocolate Zucchini Cake

- $\frac{1}{4}$ c soft butter
- $\frac{1}{2}$ c sugar
- 1 c all-purpose flour
- 2 tbsp cocoa
- $\frac{1}{4}$ tsp baking soda
- 1 tsp baking powder
- $\frac{1}{4}$ tsp cinnamon
- 1 c shredded zucchini
- $\frac{1}{2}$ c buttermilk
- 1 egg
- 1 tsp vanilla
- $\frac{1}{2}$ c chopped pecans
- $\frac{1}{2}$ c semisweet chocolate chips
- confectioners' sugar

Pumpkin Pie

- 10 $\frac{1}{2}$ oz bag marshmallows
- 1 $\frac{1}{2}$ c canned pumpkin
- $\frac{1}{2}$ tsp pumpkin pie spice
- $\frac{1}{4}$ tsp salt
- 1 tsp grated orange rind
- 8 oz thawed, non-dairy whipped topping
- 9-inch prepared graham cracker crust

Caribbean Cake

- 2 tbsp butter, melted
- $\frac{1}{4}$ c brown sugar
- $\frac{1}{4}$ c apricot preserves
- 8 oz can crushed pineapple drained well
- 2 tbsp sliced, blanched almonds
- $\frac{1}{3}$ c dried, sweetened cranberries (Craisins)
- 1 9 oz pkg yellow cake mix or $\frac{1}{2}$ box regular size
- 1 egg
- 2 tbsp rum
- 6 tbsp pineapple juice and/or water

Cherry Pie Pudding

- 21 oz cherry pie filling
- 4 c sponge or angel food cake cubes
- 2 c milk
- 4 eggs
- 1 tbsp sugar
- $\frac{1}{2}$ tsp almond extract
- 1 16 oz can drained, Bing cherries

Turtle Bars

- 1 $\frac{1}{2}$ c quick oatmeal
- $\frac{1}{2}$ c light brown sugar
- $\frac{1}{2}$ c all-purpose flour
- $\frac{1}{2}$ c melted butter
- 20 caramel candies
- 1 tbsp milk
- $\frac{1}{2}$ c milk chocolate chips
- $\frac{1}{2}$ c pecan pieces

DEFROST

DEFROST pad has two special defrosting methods.

SUPER DEFROST

Super Defrost rapidly defrosts specific foods and weights found in the SUPER DEFROST CHART.

- Suppose you want to defrost 1.0 pound boneless chicken.

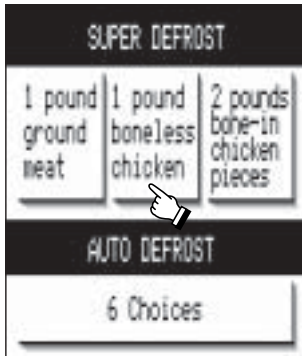

- 1 Press DEFROST pad and then touch desired food: 1 pound boneless chicken. The oven will start automatically.

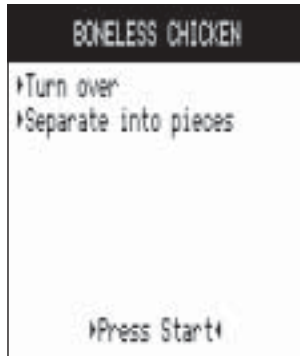

- 2 When the oven stops, read instructions on the screen, open the door, complete the instructions and close the door. Press START pad.

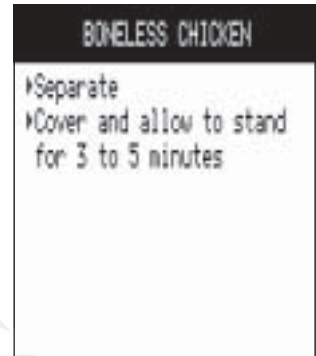

- 3 After the defrost cycle ends, read the screen. Remove the food from oven, cover and let stand for the suggested time to allow defrosting to be completed.

NOTE:

1. To defrost foods above or below the weights allowed on the SUPER DEFROST CHART, use Auto Defrost or Manual Defrost. See Auto Defrost on page 27 and Manual Defrost on page 28.
2. Super Defrost can be programmed with More or Less Time Adjustment. See page 32.

SUPER DEFROST CHART

| FOOD | AMOUNT | PROCEDURE |
|------------------------|--------|--|
| Ground meat | 1.0 lb | At pause, turn over, remove any thawed pieces and break remainder apart. At end, let stand, covered, for 3 to 5 minutes. |
| Boneless Chicken | 1.0 lb | At pause, turn over and separate into pieces. At end, let stand, covered, for 3 to 5 minutes. |
| Bone-in Chicken Pieces | 2.0 lb | At pause, turn over and separate into pieces. At end, let stand, covered, for 3 to 5 minutes. |

NOTE:

Super Defrost provides just enough defrosting that the foods can be used in recipes or for cooking. There will be some ice crystals remaining.

DEFROST

AUTO DEFROST

Auto Defrost automatically defrosts all the foods found in the AUTO DEFROST CHART below.

- Suppose you want to defrost a 2.0 pound steak.



- 1 Press DEFROST pad and then touch AUTO DEFROST 6 Choices.



- 2 Touch the desired food: Steaks.



- 3 Enter desired weight by touching the screen. Then press START pad.

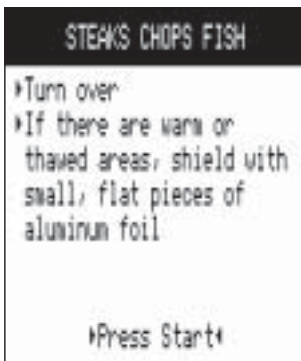

- 4 When the oven stops, read instructions on the screen, open the door, complete the instructions and close the door. Press START pad.

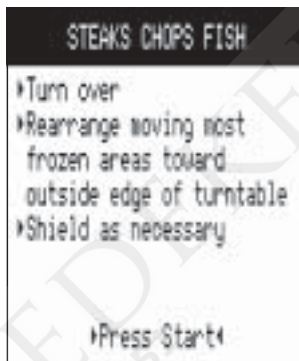

- 5 When the oven stops, read instructions on the screen, open the door, complete the instructions and close the door. Press START pad.



- 6 After the defrost cycle ends, read the screen. Remove the food from oven, cover and let stand for the suggested time to allow defrosting to be completed.

AUTO DEFROST CHART

| FOOD | AMOUNT | STANDING TIME |
|----------------------|--------------|---------------|
| Ground Meat | .5 - 3.0 lb | 5 - 10 min. |
| Steaks, Chops / Fish | .5 - 4.0 lb | 10 - 20 min. |
| Chicken Pieces | .5 - 3.0 lb | 10 - 20 min. |
| Roasts | 2.0 - 4.0 lb | 30 - 45 min. |
| Casserole | 2 - 8 cups | 5 - 15 min. |
| Soup | 1 - 8 cups | 5 - 15 min. |

NOTE:

1. You can input the amount only within the range of the AUTO DEFROST CHART.
2. Auto Defrost can be programmed with More or Less Time Adjustment. See page 32.
3. To defrost other foods or foods above or below the weights allowed on AUTO DEFROST CHART, use time and 30% power. See Manual Defrost on page 28.

DEFROST

MANUAL DEFROST

If the food that you wish to defrost is not listed on the AUTO DEFROST or SUPER DEFROST CHARTS is above or below the limits in the AMOUNT column on the AUTO DEFROST or SUPER DEFROST CHARTS, you need to defrost manually.

You can defrost any frozen food, either raw or previously cooked, by using 30% power. Follow the exact procedure found on page 16. Estimate defrosting time, enter it. Then touch Power Level on the Touch Screen and select 30%.

For either raw or previously cooked frozen food the

rule of thumb is approximately four minutes per pound. For example, defrost four minutes for one pound of frozen spaghetti sauce.

Always stop the oven periodically to remove or separate the portions that are defrosted. If food is not defrosted at the end of the estimated defrosting time, program the oven in one minute increments on 30% power until totally defrosted.

When using plastic containers from the freezer, defrost only long enough to remove from the plastic in order to place in a microwave-safe dish.

BEVERAGES

Beverages enables you to restore coffee or tea to a more suitable drinking temperature or to prepare instant coffee or tea.

- Suppose you want to make two cups of coffee.



- 1 Press BEVERAGES pad and then touch Prepare.

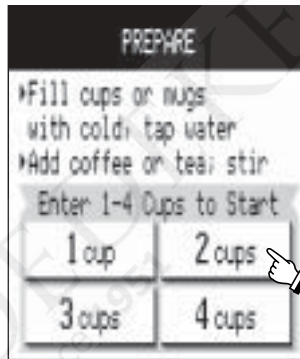

- 2 Touch desired number on the screen. The oven will start automatically.



- 3 When oven stops, follow instructions on the screen.

BEVERAGES CHART

| FOOD | AMOUNT |
|--------------------|--------------|
| Prepare coffee/tea | 1 - 4 cups |
| Reheat | 1/2 - 2 cups |

SET UP

SET UP has six functions.

1. Clock
2. Auto Start
3. Sound Adjustment
4. Child Lock
5. Video Demo
6. Screen Contrast

To use any function, press SET UP, touch desired function and follow directions on the screen.

1. CLOCK

Press the SET UP pad, touch Clock and follow the directions on the screen. See page 14.

2. AUTO START

The Auto Start function allows you to set your oven to start automatically at a later time.

- Suppose you want to start cooking a stew for 20 minutes on 50% power at 4:30 P.M. Before setting, check to make sure the clock is showing the correct time of day.

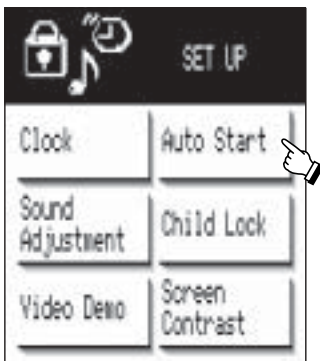

- 1 Press SET UP pad and then touch the desired function: Auto Start.

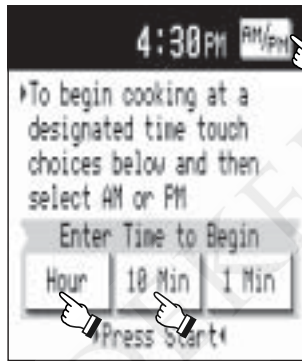

- 2 Enter start time (4:30) using the screen choices and then touch PM. Press START pad.



- 3 Enter cooking time, 2, 0, 0, 0 by using numbers on the screen. Touch Power Level.

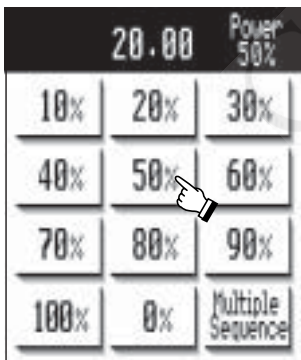

- 4 Touch 50%. The top line of the display will show time and chosen power level. Press START pad.



- 5 Auto Start time will appear.

NOTE:

1. Auto Start can be used for manual cooking only, if clock is set.
2. Be sure to choose foods that can be left in the oven safely until the Auto Start time. Acorn or butternut squash are often a good choice.

SET UP

3. SOUND ADJUSTMENT

The oven offers a choice of Simple Beep, Melody or No Sound. The oven comes set for Melody. Touch your choice on the screen and then press START. The selected sound does not change even if the electrical power supply is interrupted. Note that even when No Sound is chosen, there will be a sound for the Kitchen Timer, if it was set.

Reminder:

An audible signal reminds you that cooking, defrosting or reheating has finished. The sound will repeat every 60 seconds and continue for 30 minutes unless you touch STOP/CLEAR or open the door. To set the Reminder, touch On on the End of Cooking Reminder screen. The setting does not change even if the electrical power supply is interrupted. The Reminder cannot be set if “No Sound” was selected.

4. CHILD LOCK

The Child Lock prevents unwanted oven operation such as by small children. The oven can be set so that the control panel is deactivated or locked.

5. VIDEO DEMO

The Video Demo is an automated “tour” through many of the features of the microwave oven. You may wish to observe it when the oven is new or when you are teaching family members how to use the oven. There are five short segments in the Video Demo.

6. SCREEN CONTRAST

Normally there is no need to change the display contrast; however, should you wish to do so, touch Lighter or Darker until the contrast is as desired. And then press START pad. Be cautious when touching Lighter so that the display is always readable. The selected contrast will not change even if the electrical power supply is interrupted.

OTHER CONVENIENT FEATURES

EASY MINUTE

EASY MINUTE allows you to cook for a minute at 100% power by simply touching the EASY MINUTE pad. You can also extend cooking time in multiples of one minute by repeatedly touching the EASY MINUTE pad during manual cooking.

- Suppose you want to heat a cup of soup for one minute using 100% power.

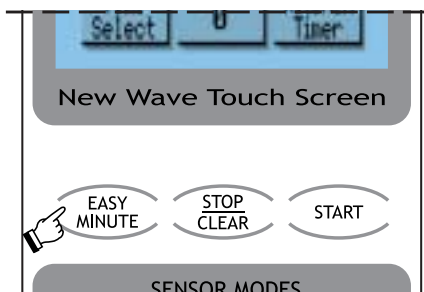

Touch EASY MINUTE pad on control panel.

NOTE:

To use EASY MINUTE, touch pad within three minutes after cooking, closing the door, touching the STOP/CLEAR pad or during cooking.

OTHER CONVENIENT FEATURES

TIME SELECT

Touch Time Select on the screen to access a new screen with 12 common cooking times at 100% power. Touch desired time and the oven starts automatically.

- Suppose you want to melt butter for 30 seconds.



1 Touch Time Select.

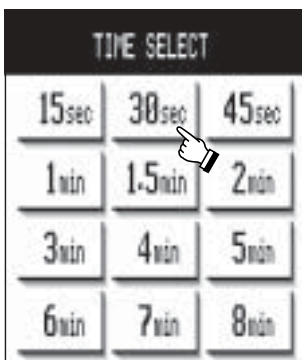

2 Touch desired time: 30 seconds.

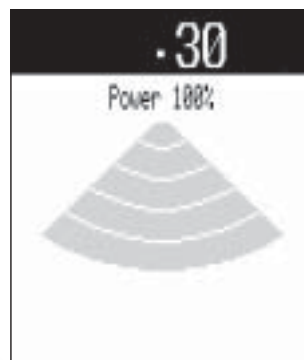

3 The oven will start automatically.

KITCHEN TIMER

Use this feature as a general purpose timer. You can enter any time up to 99 minutes and 99 seconds. If you want to cancel the timer during the count down phase, simply press STOP/CLEAR and the display will return to the Home Page.

- Suppose you want to time a three minute long distance phone call:



1 Touch Kitchen Timer.



2 Enter desired time by touching numbers : 3, 0, 0. Press START pad.



3 The Kitchen Timer will start counting down.

NOTE:

Even if all sound is off, the oven will beep when the Kitchen Timer ends.

OTHER CONVENIENT FEATURES

MORE OR LESS TIME ADJUSTMENT

The programmed cooking times are tailored to the most popular tastes. To adjust the cooking time to your individual preference use the “more” or “less” feature to either add or reduce cooking time.

- Suppose you want to cook Ground Beef for more time:

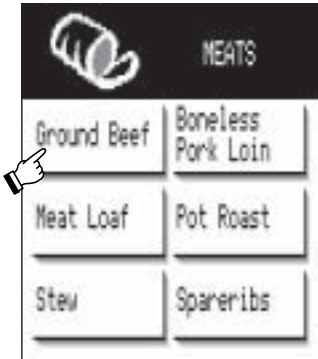

- 1 Press Meats pad in the NEW WAVE COOKBOOK and then touch Ground Beef.



- 2 Prepare the food following the information on the screen. And press START pad.

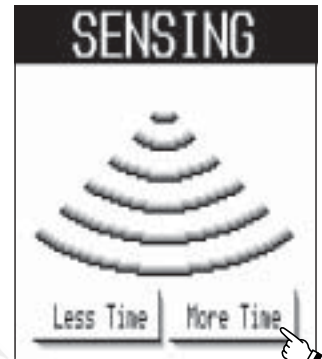

- 3 After pressing the START pad, Less Time and More Time will appear. Touch desired choice, if any.

NOTE:

1. Once you have selected either More Time or Less Time, it cannot be changed.
2. Choosing More Time or Less Time must be done within seven seconds after touching START.

GOEDEKER'S
Trusted since 1951

CLEANING AND CARE

DOOR

Wipe the window on both sides with a damp cloth to remove any spills or splatters. Metal parts will be easier to maintain if wiped frequently with a damp cloth. **Avoid the use of harsh abrasives.**

EXTERIOR

The outside surface is painted. Clean the outside with mild soap and water; rinse and dry with a soft cloth. **Do not use any type of household or abrasive cleaner.**

INTERIOR

Cleaning is easy because no heat is generated to the interior surfaces; therefore, there is no baking and setting of spills or spattering. To clean the interior surfaces, wipe with a soft cloth and warm water. **DO NOT USE ABRASIVE OR HARSH CLEANERS OR SCOURING PADS.** For heavier soil, use baking soda or a mild soap; rinse thoroughly with hot water. **NEVER SPRAY OVEN CLEANERS DIRECTLY ONTO ANY PART OF THE OVEN.**

ODOR REMOVAL

Occasionally, a cooking odor may remain in the oven. To remove, combine 1 cup water, grated peel and juice of 1 lemon and several whole cloves in a 2 cup glass measuring cup. Boil for several minutes using 100% power. Allow to set in oven until cool. Wipe interior with a soft cloth.

WAVEGUIDE COVER

Carefully wash any food particles from the waveguide cover located on the right side in the oven cavity. Do not remove the waveguide cover.

CONTROL PANEL

Care should be taken in cleaning the control panel. If the control panel becomes soiled, open the oven door before cleaning. Wipe the panel with a cloth dampened slightly with water only. Dry with a soft cloth. Do not scrub or use any sort of chemical cleaners. Close door and touch STOP/CLEAR.

TOUCH SCREEN

Wipe the touch screen with a damp cloth and then dry with a soft cloth. Do not allow soil to accumulate on the touch screen.

TURNTABLE / TURNTABLE SUPPORT

The turntable and turntable support can be removed for easy cleaning. Wash them in mild, sudsy water; for stubborn stains use a mild cleanser and scouring sponge as described above. They are also dishwasher-proof. Use upper rack of dishwasher. The turntable motor shaft is not sealed, so excess water or spills should be wiped up immediately.

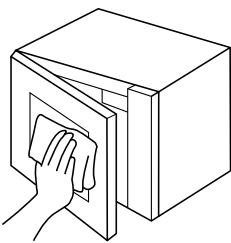

Exterior

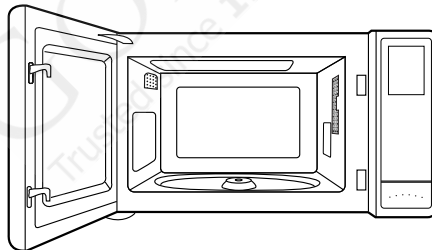

Interior



Turntable

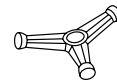

Turntable Support

SPECIFICATIONS

DMT2420S, DMT2420B, DMT2420R

| | |
|---------------------|---|
| AC Line Voltage: | Single phase 120V, 60Hz, AC only |
| AC Power Required: | 1700 watts, 14.3 amps. |
| Output Power: | 1200 watts* (IEC Test Procedure) |
| Frequency: | 2450 MHz |
| Outside Dimensions: | 24"(W) x 13 ³ / ₈ "(H) x 19 ¹ / ₈ "(D) |
| Cavity Dimensions: | 17 ³ / ₈ "(W) x 10 ¹ / ₂ "(H) x 18 ⁵ / ₈ "(D) |
| Oven Capacity: | 2.0 Cu. Ft. |
| Cooking Uniformity: | Turntable system |
| Weight: | Approx. 46 lb |

* The International Electrotechnical Commission's standardized method for measuring output wattage. This test method is widely recognized.

In compliance with standards set by:

FCC – Federal Communications Commission Authorized.

DHHS – Complies with Department of Health and Human Services (DHHS) rule, CFR, Title 21, Chapter I, Subchapter J.



– This symbol on the nameplate means the product is listed by Underwriters Laboratories, Inc.



SERVICE CALL CHECK

Please check the following before calling for service:

Place one cup of water in a glass measuring cup in the oven and close the door securely.

Operate the oven for one minute at HIGH 100%.

- A Does the oven light come on? YES _____ NO _____
- B Does the cooling fan work? YES _____ NO _____
(Put your hand over the rear ventilating openings.)
- C Does the turntable rotate? YES _____ NO _____
It is normal for the turntable to turn in either direction.
- D Is the water in the oven warm? YES _____ NO _____

If "NO" is the answer to any of the above questions, please check electrical outlet, fuse and/or circuit breaker. If they are functioning properly, CONTACT YOUR NEAREST DACOR AUTHORIZED SERVICER. A microwave oven should never be serviced by a "do-it-yourself" repair person.

NOTE: If count-down time is appearing on the screen and counting down very rapidly, follow directions below to cancel Hidden Demo.

Press STOP/CLEAR pad and hold for four seconds until an audible signal is heard.

Quickly press STOP/CLEAR key four times within the next two seconds.

QUICK REFERENCE

SENSOR MODES 17

| | |
|----------------------|----|
| REHEAT | 17 |
| POPCORN | 17 |
| BAKED POTATOES | 17 |

NEW WAVE COOKBOOK 18 - 19

VEGETABLES 18

- Broccoli/Cauliflower
- Beans/Carrots
- Mushrooms/Spinach
- Corn on the Cob/Peas
- Summer Squash/Zucchini
- Winter Squash/Acorn Squash

MEATS 18

- Ground Beef
- Boneless Pork Loin
- Meat Loaf
- Pot Roast
- Stew
- Spareribs

POULTRY 18

- Boneless Chicken Breast
- Bone-in Chicken Pieces
- Whole Chicken
- Turkey Breast
- Turkey Drumstick
- Ground Poultry

FISH/SEAFOOD 18

- Fish Fillets
- Fish Steaks
- Shrimp
- Scallops
- Clams & Mussels
- Fish Kabobs

FROZEN FOOD 18

- Vegetables
- Entrees
- Main Dishes
- Snacks
- Soft Ice Cream
- Thaw Juice Concentrate

PASTA/GRAINS 18

- White Rice
- Brown Rice
- Fresh Pasta
- Dry Pasta
- Grits
- Couscous

MICROWAVE RECIPES AND INSTRUCTIONS 20 - 25

Breakfast Bar 20

- Scrambled Eggs
- Bacon
- Hot Cereal
- Fresh Rolls or Muffins
- Frozen Rolls or Muffins
- Frozen Breakfast Food

Lunch On The Run 20

- Meal in a Cup
- Hot Dogs in Buns
- Soup
- Microwave Pizza
- Pizza Reheat
- Frozen Sandwich

One Dish Dinners 22

- Spicy Couscous
- Beef Burgundy
- Salsa Chicken
- Sweet and Sour Pork
- Seafood Pasta
- Vegetarian Orzo

Low Calorie Entrees 23

- Stuffed Acorn Squash
- Steak Fajitas
- Thai Chicken Kabobs
- Glazed Pork Tenderloin
- Salmon Romanoff
- Ratatouille

Supper Soups and Sauces 24

- Chicken Noodle
- Bouillabaisse
- Curried Vegetable
- Split Pea
- Meat Sauce
- Vegetarian Chili

Delicious Desserts 25

- Almond Bread Pudding
- Caribbean Cake
- Chocolate Zucchini Cake
- Cherry Pie Pudding
- Pumpkin Pie
- Turtle Bars

DEFROST 26 - 28

SUPER DEFROST 26

- 1 pound Ground Meat
- 1 pound Boneless Chicken
- 2 pounds Bone-in Chicken Pieces

AUTO DEFROST 27

- Ground Meat
- Steaks, Chops / Fish
- Chicken Pieces
- Roasts
- Casserole
- Soup

BEVERAGES 28

Prepare 28

Reheat 28

SET UP 29 - 30

Clock 29

Auto Start 29

Child Lock 30

Sound Adjustment 30

Video Demo 30

Screen Contrast 30

QUICK REFERENCE

For more complete information and safety precautions, refer to your Operation Manual.

SET CLOCK

If the oven has just been plugged in, touch Set Clock on the screen and follow the directions. To reset the clock, press Set Up pad on the control panel. Then touch Clock on screen.

- 1 Enter the time of day (hour).
- 2 Enter the time of day (minutes).
- 3 Select AM or PM and then press **START** pad.



MANUAL OPERATION

High Power Cooking

- 1 Enter cooking time by touching numbers on the home page.
- 2 Press **START** pad.



Variable Power Cooking

- 1 After Step 1 above, touch Power Level on the screen.
- 2 Touch desired Power Level (Ex: 30%).
- 3 Press **START** pad.



SENSOR MODES: REHEAT

Press **REHEAT** pad. Follow the directions on the TOUCH SCREEN. The oven will start automatically. When sensor detects the vapor emitted from the food, remainder of cooking time will appear.



NEW WAVE COOKBOOK

For foods not using the sensor, follow the directions on the screen to enter quantity. When cooking foods with the sensor, it is not necessary to enter quantity or weight.

- 1 Press the **VEGETABLES** pad and then touch the desired vegetable.
- 2 Touch the desired doneness and the oven will start automatically.
- 3 After cooking, follow instructions.



MICROWAVE RECIPES AND INSTRUCTIONS

- 1 Press the **Microwave Recipes and Instructions** pad and then touch the desired category.
- 2 Select the desired food from the screen.
- 3 Follow directions on the screen.
- 4 When the oven stops, follow instructions.



DEFROST: AUTO DEFROST

- 1 Press the **DEFROST** pad and then touch AUTO DEFROST 6 Choices.
- 2 Select the desired food and weight by touching the screen.
- 3 Press **START** pad.
- 4 Follow instructions.
- 5 After the defrost cycle ends, read the screen. Remove the food from oven, cover and let stand for the suggested time to allow defrosting to be completed.



SET UP: AUTO START

The Auto Start function allows you to set the oven to start automatically at a later time.

- 1 Press the **SET UP** pad and then touch Auto Start on the screen.
- 2 Follow instructions.



EASY MINUTE

Easy Minute allows you to cook for one minute at 100% power by simply touching the **EASY MINUTE** pad on the control panel.



TIME SELECT

Touch Time Select on the screen to access a new screen with 12 common cooking times at 100% power. Touch desired time and the oven starts automatically.

dacor[®]

The life of the kitchen™

DACOR INC. • 1440 Bridge Gate Drive, Diamond Bar, CA 91765
1-800-793-0093 • www.dacor.com



TINSEB323MRR0