



QuickScan® QS6500/QS6500BT



Product Reference Guide

Datalogic Scanning, Inc.
959 Terry Street
Eugene, Oregon 97402
Telephone: (541) 683-5700
Fax: (541) 345-7140

An Unpublished Work - All rights reserved. No part of the contents of this documentation or the procedures described therein may be reproduced or transmitted in any form or by any means without prior written permission of Datalogic Scanning, Inc. or its subsidiaries or affiliates ("Datalogic" or "Datalogic Scanning"). Owners of Datalogic products are hereby granted a non-exclusive, revocable license to reproduce and transmit this documentation for the purchaser's own internal business purposes. Purchaser shall not remove or alter any proprietary notices, including copyright notices, contained in this documentation and shall ensure that all notices appear on any reproductions of the documentation.

Should future revisions of this manual be published, you can acquire printed versions by contacting your Datalogic representative. Electronic versions may either be downloadable from the Datalogic website (www.scanning.datalogic.com) or provided on appropriate media. If you visit our website and would like to make comments or suggestions about this or other Datalogic publications, please let us know via the "Contact Datalogic" page.

Disclaimer

Datalogic has taken reasonable measures to provide information in this manual that is complete and accurate, however, Datalogic reserves the right to change any specification at any time without prior notice. Datalogic is a registered trademark of Datalogic S.p.A. in many countries and the Datalogic logo is a trademark of Datalogic S.p.A. All other brand and product names referred to herein may be trademarks of their respective owners.

This product may be covered by one or more of the following patents: 6,293,467 • 6,612,495 • 6,705,527 •
Other Patents Pending

Table of Contents

Chapter 1 Getting Started	1-1
About This Manual	1-1
Manual Conventions	1-2
Default Information	1-2
Nomenclature	1-2
Symbologies	1-3
Linear Imager Settings	1-3
Return to Factory Defaults	1-3
Chapter 2 Bluetooth Models	2-1
Linking an Imager with a Base Station	2-1
Unlinking	2-2
Battery Charging	2-3
Paging the Imager	2-3
Chapter 3 General Features	3-1
Double Read Timeout	3-1
Imager Timeout	3-3
Read Verification	3-4
LED and Beeper Indicators	3-6
Power On Alert	3-6
LED Idle State	3-6
Good Read: When to Indicate	3-7
Good Read Beep Control	3-8
Good Read Beep Frequency	3-8
Good Read Beep Length	3-9
Good Read Beep Volume	3-11
Scanning/Imaging Features	3-12
Scan Mode	3-12
Stand Mode LED	3-14
Scan Illumination LED Timeout	3-14
Inverted Image Scan	3-15
Global Features	3-16
Global Minimum Code Length	3-16
Global Maximum Code Length.....	3-17
Chapter 4 Interface Related Features	4-1
Interface Selection	4-4
Interface Features	4-8
Global Interface Features	4-8
RS-232 Interface Features	4-9
Hardware Flow Control.....	4-11
Intercharacter Delay.....	4-11
Software Flow Control.....	4-11

Host Echo	4-14
Host Echo Quiet Interval	4-14
Signal Voltage: Normal/TTL.....	4-14
RS-232 Invert	4-14
Beep on ASCII BEL.....	4-16
Beep on Not on File.....	4-16
ACK NAK Options.....	4-16
ACK Character.....	4-18
NAK Character.....	4-19
Retry on ACK NAK Timeout	4-20
ACK NAK Timeout Value	4-21
ACK NAK Retry Count.....	4-22
ACK NAK Error Handling	4-23
Transmission Failure Indication	4-24
IBM-USB Interface Features	4-25
IBM-USB Device usage	4-25
IBM	4-26
IBM Transmit Labels in Code 39 Format	4-26
Keyboard Wedge/USB Keyboard	4-27
Wand Emulation	4-34
Supported Symbologies	4-34
Wand Emulation Bar Code Format	4-34
Bar/Space Polarity	4-35
Initial Polarity.....	4-35
Signal Speed.....	4-36
Transmit Trailing Noise.....	4-36
Transmit Leading Noise	4-37
Symbology Conversion	4-37
Chapter 5 Data Editing	5-1
Data Editing Overview	5-1
Please Keep In Mind... ..	5-2
Prefix/Suffix.....	5-2
Preamble/Postamble	5-5
Symbology, I.D. and Code Length	5-8
Data Group Characters	5-11
Case Conversion	5-14
Chapter 6 Symbologies	6-1
UPC-A	6-2
Disable/Enable UPC-A	6-2
Checksum Transmission	6-2
Expand UPC-A to EAN-13	6-2
Truncate Leading/Ending	6-4
Code I.D. Selection	6-5
Example: Setting the UPC-A Code I.D.....	6-5
UPC-A Data Group Characters	6-7
UPC-A — continued	6-9
Add-ons	6-9
UPC-E	6-11
Disable/Enable UPC-E	6-11

Checksum Transmission	6-11
Truncate/Expand	6-11
Truncate Leading/Ending	6-13
Code I.D. Selection	6-14
Example: Setting the UPC-E Code I.D.	6-14
UPC-E Data Group Characters	6-16
Add-ons	6-18
EAN-13	6-20
Disable/Enable EAN-13	6-20
Checksum Transmission	6-20
ISBN/ISSN	6-20
EAN-13 — continued	6-22
ISBN ID Setting	6-22
Example: Setting the ISBN ID.....	6-22
Truncate Leading/Ending	6-24
Code I.D. Selection	6-25
Example: Setting the EAN-13 Code I.D.	6-25
EAN-13 Data Group Characters	6-27
Add-ons	6-29
EAN-8	6-31
Disable/Enable EAN-8	6-31
Checksum Transmission	6-31
Truncate/Expand	6-32
Truncate Leading/Ending	6-33
Code I.D. Selection	6-34
Example: Setting the EAN-8 Code I.D.	6-34
EAN-8 Data Group Characters	6-36
Add-ons	6-38
GTIN	6-40
Disable/Enable GTIN	6-40
Code I.D. Selection	6-40
Example: Setting the GTIN Code I.D.....	6-40
RSS-14	6-42
Disable/Enable RSS-14	6-42
Checksum Transmission	6-42
UCC/EAN 128 Emulation	6-42
Truncate Leading/Ending	6-44
Code I.D. Selection	6-45
Example: Setting the RSS-14 Code I.D.	6-45
RSS-14 Data Group Characters	6-47
RSS Expanded	6-49
Disable/Enable RSS Expanded	6-49
UCC/EAN 128 Emulation	6-49
Minimum/Maximum Code Length	6-50
Truncate Leading/Ending	6-51
Code I.D. Selection	6-52
Example: Setting the RSS Expanded Code I.D.....	6-52
RSS Expanded Data Group Characters	6-54
RSS Limited	6-56
Disable/Enable RSS Limited	6-56
Checksum Transmission	6-56
UCC/EAN 128 Emulation	6-56

Truncate Leading/Ending	6-58
Code I.D. Selection	6-59
Example: Setting the RSS Limited Code I.D.....	6-59
RSS Limited Data Group Characters	6-61
Code 39	6-63
Disable/Enable Code 39	6-63
Checksum Verification	6-63
Checksum Transmit	6-63
Minimum/Maximum Code Length	6-65
Truncate Leading/Ending	6-66
Code I.D. Selection	6-67
Example: Setting the Code 39 Code I.D.	6-67
Code 39 Data Group Characters	6-69
Format	6-71
Append	6-71
Start/End Transmission	6-71
Pharmacode 39	6-73
Disable/Enable Pharmacode 39	6-73
Leading 'A'	6-73
Minimum/Maximum Code Length	6-74
Truncate Leading/Ending	6-75
Code I.D. Selection	6-76
Example: Setting the Pharmacode 39 Code I.D.	6-76
Pharmacode 39 Data Group Characters	6-78
Code 128	6-80
Disable/Enable Code 128	6-80
Checksum Verification	6-80
Checksum Transmit	6-80
Function Code Transmission	6-80
Minimum/Maximum Code Length	6-82
Truncate Leading/Ending	6-83
Code I.D. Selection	6-84
Example: Setting the Code 128 Code I.D.	6-84
Code 128 Data Group Characters	6-86
EAN-128	6-88
Format as EAN-128	6-88
Append	6-88
UCC/EAN-128 ID setting	6-89
Interleaved 2 of 5	6-90
Disable/Enable Interleaved 2 of 5	6-90
Checksum Verification	6-90
Checksum Transmit	6-90
Fixed Length Control	6-92
Minimum/Maximum Code Length	6-94
Truncate Leading/Ending	6-95
Code I.D. Selection	6-96
Example: Setting the Interleaved 2 of 5 Code I.D.....	6-96
Interleaved 2 of 5 Data Group Characters	6-98
Industrial 2 of 5	6-100
Disable/Enable Industrial 2 of 5	6-100
Minimum/Maximum Code Length	6-101
Truncate Leading/Ending	6-102

Code I.D. Selection	6-103
Example: Setting the Industrial 2 of 5 Code I.D.....	6-103
Industrial 2 of 5 Data Group Characters	6-105
Matrix 2 of 5 (Eur)	6-107
Disable/Enable Matrix 2 of 5	6-107
Checksum Verification	6-107
Checksum Transmit	6-107
Minimum/Maximum Code Length	6-109
Truncate Leading/Ending	6-110
Code I.D. Selection	6-111
Example: Setting the Matrix 2 of 5 Code I.D.	6-111
Matrix 2 of 5 Data Group Characters	6-113
Codabar	6-115
Disable/Enable Codabar	6-115
Checksum Verification	6-115
Checksum Transmit	6-115
Minimum/Maximum Code Length	6-117
Truncate Leading/Ending	6-118
Code I.D. Selection	6-119
Example: Setting the Codabar Code I.D.	6-119
Codabar Data Group Characters	6-121
Start/End Type	6-123
Start/End Transmission	6-123
Code 93	6-124
Disable/Enable Code 93	6-124
Checksum Verification	6-124
Checksum Transmit	6-124
Minimum/Maximum Code Length	6-126
Truncate Leading/Ending	6-127
Code I.D. Selection	6-128
Example: Setting the Code 93 Code I.D.	6-128
Code 93 Data Group Characters	6-130
Code 11	6-132
Disable/Enable Code 11	6-132
Checksum Verification	6-132
Checksum Transmit	6-132
Minimum/Maximum Code Length	6-134
Truncate Leading/Ending	6-135
Code I.D. Selection	6-136
Example: Setting the Code 11 Code I.D.	6-136
Code 11 Data Group Characters	6-138
MSI/Plessey	6-140
Disable/Enable MSI/Plessey	6-140
Checksum Verification	6-140
Checksum Transmit	6-140
Minimum/Maximum Code Length	6-142
Truncate Leading/Ending	6-143
Code I.D. Selection	6-144
Example: Setting the MSI/Plessey Code I.D.	6-144
MSI/Plessey Data Group Characters	6-146
UK-Plessey	6-148
Disable/Enable UK/Plessey	6-148

Checksum Verification	6-148
Checksum Transmit	6-148
Minimum/Maximum Code Length	6-150
Truncate Leading/Ending	6-151
Code I.D. Selection	6-152
Example: Setting the UK/Plessey Code I.D.	6-152
UK-Plessey Data Group Characters	6-154
Telepen	6-156
Disable/Enable Telepen	6-156
Checksum Verification	6-156
Checksum Transmit	6-156
Format	6-156
Minimum/Maximum Code Length	6-158
Truncate Leading/Ending	6-159
Code I.D. Selection	6-160
Example: Setting the Telepen Code I.D.	6-160
Telepen Data Group Characters	6-162
Standard 2 of 5	6-164
Disable/Enable Standard 2 of 5	6-164
Checksum Verification	6-164
Checksum Transmit	6-164
Minimum/Maximum Code Length	6-166
Truncate Leading/Ending	6-167
Code I.D. Selection	6-168
Example: Setting the Standard 2 of 5 Code I.D.	6-168
Standard 2 of 5 Data Group Characters	6-170
Code 16K	6-172
Disable/Enable Code 16K	6-172
Truncate Leading/Ending	6-173
Code I.D. Selection	6-174
Example: Setting the Code 16K Code I.D.	6-174
Code 16K Data Group Characters	6-176
China Post	6-178
Disable/Enable China Post	6-178
Minimum/Maximum Code Length	6-179
Truncate Leading/Ending	6-180
Code I.D. Selection	6-181
Example: Setting the China Post Code I.D.	6-181
China Post Data Group Characters	6-183
PDF 417	6-185
Disable/Enable PDF 417	6-185
Escape Sequence Transmit	6-185
Truncate Leading/Ending	6-186
Code I.D. Selection	6-187
Example: Setting the PDF 417 Code I.D.	6-187
PDF 417 Data Group Characters	6-189
Micro PDF 417	6-191
Disable/Enable Micro PDF 417	6-191
Escape Sequence Transmit	6-191
Truncate Leading/Ending	6-192
Code I.D. Selection	6-193
Example: Setting the Micro PDF 417 Code I.D.	6-193

Micro PDF 417 Data Group Characters	6-195
EAN UCC Composite	6-197
Disable/Enable EAN UCC Composite	6-197
UCC/EAN 128 Emulation	6-197
Truncate Leading/Ending	6-198
Code I.D. Selection	6-199
Example: Setting the EAN UCC Composite Code I.D.	6-199
EAN UCC Composite Data Group Characters	6-201
Code 4/5	6-203
Disable/Enable Code 4 and Code 5	6-203
Data Transmission Format	6-203
Code I.D. Selection	6-204
Example: Setting the Code 4/5 Code I.D.	6-204
Code 4/5 Data Group Characters	6-206
Chapter 7 Bluetooth Features	7-1
Auto Update	7-1
Deep Sleep Mode	7-3
Leash Alarm	7-4
Bluetooth Connectivity Mode	7-6
Inquiry Beep Control	7-8
Chapter 8 Product Specifications	8-1
Imager Product Specifications	8-1
Standard Cable Pinouts (Primary Interface Cables)	8-2
RS-232	8-2
Keyboard Wedge	8-2
USB	8-3
IBM Port 5B/9B/17	8-3
Appendix A ASCII Conversion Chart	A-1
Appendix B Alpha-Numeric Pad	B-1
Appendix C Keyboard Function Key Mappings.....	C-1
Keyboard Model Cross Reference	C-1
Appendix D Default Settings	D-1
Defaults by Symbology	D-1
Interface Default Exceptions	D-2
IBM Interfaces	D-2
RS-232 Wincor/Nixdorf	D-3
Keyboards	D-4
Wand Emulation	D-4
Appendix E List Commands.....	E-1
Parameter Settings List	E-1
Chapter F LED & Beeper Indications	F-1

Bluetooth Imager Indications	F-1
Bluetooth Base Station Indications	F-3
Appendix G Sample Symbols.....	G-1
Sample Symbols for PDF Models ONLY	G-2

Chapter 1

Getting Started

The linear imager uses a 16-bit processor and enhanced image processing algorithms to attain industry-leading speeds of 450 scans per second. Depth of field performance allows scanning of a low resolution shipping label at a distance of 1.5 meters. Even poor quality bar codes are readable with this scanner. Bright environments such as direct sunlight or well-lighted retail environments are not a problem; the linear imager provides accurate scans in strong ambient light up to 75,000 LUX.

The unit is built to withstand tough industrial environments with a durable rubber overmolding to protect all contact points and an IP52 protection rating. The linear imager is lightweight at 5.64 ounces (160 grams) and has an ergonomic comfort grip for ease of use.

About This Manual

This Product Reference Guide (PRG) contains the information listed below. For installation, maintenance, troubleshooting and warranty information, see the Quick Reference Guide (QRG). Copies of other publications for this product are downloadable free of charge from the website listed on the back cover of this manual.

[Chapter 1, Getting Started](#), presents this manual's contents, describes features and specifications, and lists the bar code symbologies the linear imager will read.

[Chapter 3, General Features](#), [Chapter 4, Interface Related Features](#), [Chapter 5, Data Editing](#), and [Chapter 6, Symbologies](#) all provide programming instructions and bar code labels allowing custom configuration of your imager.

[Chapter 8, Product Specifications](#), lists product data such as dimensions, electrical, environmental, etc.

The appendices contain references and tables needed with this manual.

Manual Conventions

The symbols listed below are used in this manual to notify the reader of key issues or procedures that must be observed when using the linear imager:



Notes contain information necessary for properly diagnosing, repairing and operating the linear imager.

NOTE



The **CAUTION** symbol advises you of actions that could damage equipment or property.

CAUTION

Default Information

The highlighted and bold text configuration item values marked throughout the programming sections are for the RS-232 Standard interface. Default exceptions for other interfaces are listed in [Appendix D](#).

Nomenclature

[Figure 1-1a](#) illustrates the features of the corded version of the linear imager and [Figure 1-1b](#) represents the BlueTooth version.

Figure 1-1

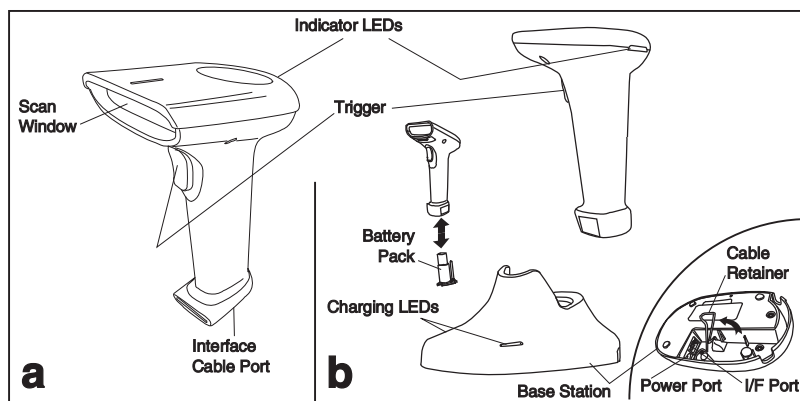

Symbologies

In addition to standard linear bar code symbologies, the PDF model of the linear imager also reads 2-Dimensional stacked bar code symbologies such as PDF417, Micro PDF 417 and EAN UCC Composite.

For more information plus a complete listing of available symbology types, turn to the [Symbologies](#) chapter of this manual.

Linear Imager Settings

The linear imager is factory programmed for the most common terminal and communications settings. If you need to change these settings, programming is accomplished by scanning the bar codes in this guide.

In the programming chapters, factory default settings are indicated with bold text and yellow highlighting. These defaults represent the settings for the RS-232 standard interface. For a listing of defaults for other interfaces, reference [Chapter D, Default Settings](#), in the section titled [Interface Default Exceptions](#).

Return to Factory Defaults

Scan the two bar codes below to reset the imager (handheld) and Base Station to factory settings. These bar codes can be used to return the imager to a “known” working state when the present programming status is not known, faulty, or suspect.

Return handheld to
factory defaults



Return Base Station to
factory defaults



NOTES

Chapter 2

Bluetooth Models

The following features and descriptions apply only to Bluetooth (BT) models of the imager.

Linking an Imager with a Base Station

Follow these instructions to link the two devices:

1. Connect power to the Base Station. The radio LED (marked with an antenna symbol) will blink amber and the Base Station will beep.
2. To ensure the Base Station is unlinked from any other imagers, press the button located on its bottom side for three seconds.
3. Place the imager in the Base Station for one minute to get a small charge in the battery.
4. Read the label on the Base Station with the imager. The imager will sound a good read beep and the LED will flash amber.
5. Replace the imager in the Base Station to continue the charge.

Once an imager is linked to a Base Station, they will remain linked until specific action is taken to unlink them (see [Unlinking](#)). They will remain linked if the Base Station is unplugged, if the battery is removed from the imager or if the entire charge is used up, and if the imager is taken out of range of the Base Station. Under normal operation, scanning of the link label will only be required once in the life of the product.

Unlinking

There are three ways to unlink an imager from a Base Station:



1. **Scan the “Unlink and Sleep” bar code** — Reading the unlink bar code above while the imager is in range of the Base Station will break the link between the two devices and allow another imager to link to the Base Station. It will also place the imager in Sleep Mode. If the bar code is read when the imager is out of range of its linked Base Station, the imager will unlink, but the Base Station will remain linked to the imager and will not allow another imager to be linked to it until the unlink button is pressed, the original imager is brought in range, linked, and then unlinked again.
2. **Push the button on the bottom of the Base Station** — Pushing the button on the Base Station while the imager is in range will break the link between the devices. If the button is pushed while the imager is out of range, the Base Station will unlink and make itself available to other imagers. The imager will not automatically break its link with the Base Station, but can be linked to any other Base Station by reading its link label .
3. **Scan the link label on an alternate Base Station** — Scanning the link label on a Base Station with an imager that is linked with another Base Station will drop the link between the original pair and establish a link between the imager and the new Base Station. If the new link is performed within range of the old Base Station, it is free to establish a link to the next imager that reads its link label. If it is done outside the range of the old Base Station, it retains its old link and will not allow a new imager to link to it until its unlink button is pressed.

Battery Charging

The imager contains a 1000mAh Lithium-Ion rechargeable battery. A fully charged battery will provide up to 12,000 scans over a 12 hour period. Actual charge life on the imager will depend on the configuration of the how the imager is configured via the programable features in this manual; in particular, **Deep Sleep Mode** and **Leash Alarm** settings can impact battery life.

When the imager is placed in the Base Station, the battery will automatically charge. While charging is taking place, the charging LED (marked with a battery symbol) will blink green. When the battery is fully charged, the charging LED will stay on a solid green.

If there is an error in charging either with a failure in the charging circuit or with a failure of the battery, the charging LED will flash red. When this happens, the battery should be replaced

Paging the Imager

If the imager is misplaced in the area around the Base Station, it can be located by momentarily pressing the button on the bottom of the Base Station. When the button is momentarily pressed, a message is sent to the imager instructing it to sound a series of six short beeps. If the imager is out of range of the Base Station or in Deep Sleep Mode, paging will not work.









NOTES

Chapter 3





General Features

Double Read Timeout

The Double Read Timeout feature sets a time limit that determines how much time must pass before reading the same label again (e.g. two identical items in succession).













START	
DURATION	BARCODE
0.1 Second	
0.2 Second	
0.3 Second	
0.4 Second	
0.5 Second	
0.6 Second	
0.7 Second	
0.8 Second	

General Features





START	
DURATION	BARCODE
0.9 Second	
1 Second	
END	

Imager Timeout

The Imager Timeout feature sets the time for automatically switching the unit off when the imager is not in use.





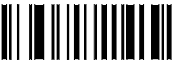

START	
DURATION	BARCODE
1 Second	
2 Seconds	
3 Seconds	
4 Seconds	
5 Seconds	
6 Seconds	
7 Seconds	
8 Seconds	
9 Seconds	
10 Seconds	
11 Seconds	
12 Seconds	

General Features





START	
DURATION	BARCODE
13 Seconds	
14 Seconds	
15 Seconds	
END	

Read Verification

Sets the number of times a bar code must be read before it is transmitted.

START	
# of TIMES	BARCODE
None	
1	
2	
3	
4	
5	



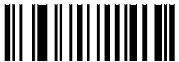

Read Verification

START	
# of TIMES	BARCODE
6	
7	
8	
9	
END	

LED and Beeper Indicators

Power On Alert





Disables or enables the indication (LED and/or Beeper) that the imager is receiving power.

START	
STATE	BARCODE
Disable	
Enable	
END	

LED Idle State

This feature specifies the state of the green scanner LED when the scanner is idle and ready to read a label. Options are:

- Off
- On dim

START	
STATE	BARCODE
LED OFF	
LED ON	
END	

Good Read: When to Indicate





This feature specifies when the imager will provide indication (beep and/or flash its green LED) upon successfully reading a bar code. Choices are:

- Good Read = Indicate after decode
- Good Read = Indicate after transmit
- Good Read = Indicate after CTS goes inactive, then active



This option, which uses CTS, is only valid for RS-232 interfaces.



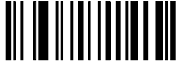

NOTE

START	
INDICATE	BARCODE
After decode	
After transmit	
After CTS goes inactive, then active	
END	

General Features







Good Read Beep Control

This feature enables/disables the imager's ability to beep upon a successful decode of a label.







START	
STATE	BARCODE
Disable	
Enable	
END	

Good Read Beep Frequency

Adjusts the good read beep to sound at a selectable low, medium or high frequency, selectable from the list below. (Controls the beeper's pitch/ tone.)



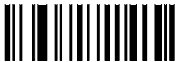

START	
FREQUENCY	BARCODE
2000 Hz	
2100 Hz	
2200 Hz	
2300 Hz	
2400 Hz	

LED and Beeper Indicators







START	
FREQUENCY	BARCODE
2500 Hz	
2600 Hz	
2700 Hz	
2800 Hz	
2900 Hz	
END	

Good Read Beep Length

Specifies the duration of a good read beep.











START	
LENGTH	BARCODE
60msec	
80msec	
100msec	
120msec	

General Features

START	
LENGTH	BARCODE
140msec	
160msec	
180msec	
200msec	
END	

Good Read Beeper Volume

Selects the beeper volume (loudness) upon a good read beep. There are five selectable volumes, with each volume increment adding approximately five decibels to the previous level.

START	
VOLUME	BARCODE
Off	
Level 1	
Level 2	
Level 3	
Level 4	
Level 5	
Level 6	
Level 7	
END	







Scanning/Imaging Features

Scan Mode

Selects the scan operating mode for the imager. Selections are:

- **Good read off** — The trigger must be pressed to activate scanning. The light source stops scanning when there is a successful read or no bar code is decoded after the "[Imager Timeout](#)" has elapsed.
- **Momentary** — The trigger acts as a switch. Pressing the trigger activates scanning; releasing it stops scanning.
- **Alternate** — The trigger acts as a toggle switch. Pressing the trigger activates scanning; pressing it a second time stops scanning.
- **Timeout off** — The trigger must be pressed to activate scanning. The imager stops scanning if no barcode is decoded within the time duration set for the "[Imager Timeout](#)" period.
- **Stand Mode** — The imager continuously reads regardless of whether the trigger is pressed or "[Imager Timeout](#)" has elapsed.





Scan Mode – continued

START	
MODE	BARCODE
Good read off	
Momentary	
Alternate	
Timeout off	
Stand mode	
END	

General Features





Stand Mode LED

When this feature is set to ON while in stand mode, the illumination LEDs go to a dim state after a timeout of reading no labels. When set to OFF in stand mode, the illumination LEDs go off after a timeout of reading no labels. In both cases, the illumination LEDs come back on when something passes in front of the imager.





START	
STATE	BARCODE
LED OFF	
LED ON	
END	

Scan Illumination LED Timeout

Limits the time following pressing the trigger that the illumination LED (aiming light) is lit. Disabling this feature turns the illumination off. Selecting “Continue” means the imager always keeps reading regardless of whether the trigger button is pressed or the standby duration has elapsed.





START	
DURATION	BARCODE
Disable	
30 Seconds	
60 Seconds	

Scanning/Imaging Features

START	
DURATION	BARCODE
90 Seconds	
120 Seconds	
150 Seconds	
180 Seconds	
Continue	
END	

Inverted Image Scan





With this option enabled, the imager will scan black/white bar codes with a white/black background.

START	
MODE	BARCODE
Disable	
Enable	
END	

Global Features





Global Minimum Code Length

Global minimum length can be set to qualify data entry. The length is defined as the actual bar code data length to be sent. bar code labels with lengths exceeding these limits will be rejected. Ensure that the minimum-length setting is no greater than the maximum-length setting; otherwise, the labels of the symbology will not be readable. In particular, you can set the same value for both minimum and maximum lengths to force decoding of only fixed-length bar codes. This setting has no effect on certain symbologies of fixed length.

START	
MODE	BARCODE
	<p>Global Minimum length can be set from 0 to 255. To set this feature, scan the “START” bar code above to place the unit in Programming Mode, then the “Set Global Minimum Length,” followed by the digits from the Alphanumeric table in Appendix B. Alpha-Numeric Pad representing your desired minimum length. Accept your selection by scanning the “SET” bar code below and finally, exit programming mode by scanning the “END” barcode below.</p> <p>DEFAULT SETTING FOR THIS FEATURE: 4</p>
Set Global Minimum Length	
SET	
END	

Global Maximum Code Length

Global maximum length can be set to qualify data entry. The length is defined as the actual bar code data length to be sent. bar code labels with lengths exceeding these limits will be rejected. Ensure that the minimum-length setting is no greater than the maximum-length setting; otherwise, the labels of the symbology will not be readable. In particular, you can set the same value for both minimum and maximum lengths to force decoding of only fixed-length bar codes. This setting has no effect on certain symbologies of fixed length.

START	
MODE	BARCODE
	<p>Global Maximum length can be set from 0 to 255. To set this feature, scan the “START” bar code above to place the unit in Programming Mode, then the “Set Global Maximum Length,” followed by the digits from the Alphanumeric table in Appendix B, Alpha-Numeric Pad representing your desired maximum length. Accept your selection by scanning the “SET” bar code below and finally, exit programming mode by scanning the “END” barcode below.</p> <p>DEFAULT SETTING FOR THIS FEATURE: 64</p>
Set Global Maximum Length	
SET	
END	

NOTES

Chapter 4

Interface Related Features

At the time of this writing, the Imager supports the interfaces listed in [Table 4-1](#). Select the desired interface type from the table, then reference the page number given for the customizable features section associated with each interface. See [Table 4-2](#) for a description of each Keyboard Wedge interface type (A through Y as listed).

Interface Related Features

Table 4-1. Interfaces Supported

RS-232	Page	Keyboard Wedge	Page
RS-232 Standard	4-9	Keyboard Wedge I ^a	4-27
RS-232 Wincor-Nixdorf	4-9	Keyboard Wedge J ^a	4-27
IBM		Keyboard Wedge K ^a	4-27
IBM 4683 Port 5B	4-25	Keyboard Wedge L ^a	4-27
IBM 4683 Port 9B	4-25	Keyboard Wedge M ^a	4-27
IBM 4683 Port 17	4-25	Keyboard Wedge N ^a	4-27
USB		Keyboard Wedge O ^a	4-27
IBM USB	4-25	Keyboard Wedge P ^a	4-27
USB Keyboard	4-25	Keyboard Wedge Q ^a	4-27
Keyboard Wedge		Keyboard Wedge R ^a	4-27
Keyboard Wedge A ^a	4-27	Keyboard Wedge S ^a	4-27
Keyboard Wedge B ^a	4-27	Keyboard Wedge T ^a	4-27
Keyboard Wedge C ^a	4-27	Keyboard Wedge U ^a	4-27
Keyboard Wedge D ^a	4-27	Keyboard Wedge V ^a	4-27
Keyboard Wedge E ^a	4-27	Keyboard Wedge W ^a	4-27
Keyboard Wedge F ^a	4-27	Keyboard Wedge X ^a	4-27
Keyboard Wedge G ^a	4-27	Keyboard Wedge Y ^a	4-27
Keyboard Wedge H ^a	4-27	Wand Emulation	4-34

a. Consult Table 4-2 for more information regarding keyboard wedge interface types.



NOTE

The correct interface cable is included for the imager interface type you ordered.

Table 4-2. Keyboard Wedge Interface Reference











I/F Type	PCs Supported
A	PC/XT w/Alternate Key Encoding
B	AT, PS/2 25-286, 30-286, 50, 50Z, 60, 70, 80, 90 & 95 w/Alternate Key Encoding
C	PS/2 25 and 30 w/Alternate Key Encoding
D	PC/XT w/Standard Key Encoding
E	AT, PS/2 25-286, 30-286, 50, 50Z, 60, 70, 80, 90 & 95 w/Standard Key Encoding
F	PS/2 25 and 30 w/Standard Key Encoding
G	IBM 3xxx w/122 keyboard
H	IBM 3xxx w/102 keyboard
I	PS/55 5530T w/104 keyboard
J	NEC 9801
K	WYSE 30/30+ WY-30 Keyboard 83 Keys
L	WYSE 60/85/99 GT/150/160/285 Style IBM Enhanced PC, 520/520ES Style IBM Enhanced PC FR WYSE 55/65/65 ES/120/185/325 Style IBM Enhanced PC
M	WYSE 60/85/99 GT/150/160/285 ANSI Keyboard 105 Keys, 520/520 ES ANSI Keyboard 105 Keys WYSE 55/65/65 ES/120/185/325 ANSI Keyboard 105 Keys
N	WYSE 60/85/99 GT/150/160/285 ASCII Kbd, 520/520 ES ASCII Kbd WYSE 55/65/65 ES/120/185/325 ASCII Keyboard
O	WYSE 60/85/99 GT/150/160/285 ANSI W285 Keyboard 105 Keys, 520/520 ES ANSI W285 Keyboard 105 Keys WYSE 55/65/65 ES/120/185/325 ANSI W285 Keyboard 105 Keys
P	WYSE WINTERM 3320 SE
Q	IBM 3153 IBM 316X, 3179/3180/319X/3270
R	IBM 3151/3152-010, 347X/348X
S	DIGITAL VT 220/320/330/340/350/382
T	DIGITAL VT420
U	DIGITAL VT 510/520 IBM ANSI Style Keyboard
V	DIGITAL VT 510/520 IBM PC Style Keyboard
W	SUN SPARC 5/10
X	SUN 420/440, ITX
Y	WYSE 370/355 Style Enhanced IBM PC













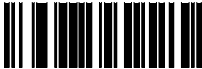

Reference [Appendix C, Keyboard Function Key Mappings](#) for more information about keyboards.

NOTE









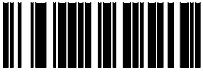

Interface Selection

START	
STATE	BARCODE
RS-232 Standard	
RS-232 Wincor-Nixdorf	
IBM 4683 Port 5B	
IBM 4683 Port 9B	
IBM 4683 Port 17	
IBM USB	
USB Keyboard	
Keyboard Wedge A	
Keyboard Wedge B	
Keyboard Wedge C	





Interface Selection

START	
STATE	BARCODE
Keyboard Wedge D	
Keyboard Wedge E	
Keyboard Wedge F	
Keyboard Wedge G	
Keyboard Wedge H	
Keyboard Wedge I	
Keyboard Wedge J	
Keyboard Wedge K	
Keyboard Wedge L	
Keyboard Wedge M	
Keyboard Wedge N	

Interface Related Features









START	
STATE	BARCODE
Keyboard Wedge O	
Keyboard Wedge P	
Keyboard Wedge Q	
Keyboard Wedge R	
Keyboard Wedge S	
Keyboard Wedge T	
Keyboard Wedge U	
Keyboard Wedge V	
Keyboard Wedge W	
Keyboard Wedge X	

Interface Selection









START	
STATE	BARCODE
Keyboard Wedge Y	
Wand Emulation	
END	

Interface Features

Global Interface Features

START	
STATE	BARCODE
Obey Host Commands	
Ignore Host Commands	
Disable Debug Mode	
Enable Debug Mode	
Host Transmission Buffers = 1	
Host Transmission Buffers = 2	
END	

RS-232 Interface Features

START	
STATE	BARCODE
1200 Baud	
2400 Baud	
4800 Baud	
9600 Baud	
19200 Baud	
38400 Baud	
57600 Baud	
115200 Baud	

RS-232 Interface Features – cont.

START	
STATE	BARCODE
7 Data Bits	
8 Data Bits	
1 Stop Bit	
2 Stop Bits	
Parity = None	
Parity = Even	
Parity = Odd	
END	

RS-232 Interface Features — cont.

Hardware Flow Control

Disable Hardware Control — The imager transmits to the host regardless of any activity on the CTS line.

Enable CTS Flow Control — The CTS signal controls transmission of data to the host.

Enable CTS Scan Control — The CTS line must be active for the imager to read and transmit data. While the CTS line is inactive, the imager remains in a host-disabled state; following a successful label transmission, the CTS signal must transition to inactive and then to active to enable scanning for the next label.















Intercharacter Delay

This delay is inserted after each data character transmitted. If the transmission speed is too high, the system may not be able to receive all characters. You may need to adjust the delay to make the system work properly.





Software Flow Control

Disables/Enables software control using XON/XOFF characters.

RS-232 Interface Features – cont.

START	
STATE	BARCODE
Disable Hardware Control	
Enable CTS Flow Control	
Enable CTS Scan Control	
Inter-Char Delay = No Delay	
Interchar Delay = 10 msec	
Interchar Delay = 20 msec	
Interchar Delay = 30 msec	
Interchar Delay = 40 msec	
Interchar Delay = 50 msec	
Interchar Delay = 60 msec	
Interchar Delay = 70 msec	
Interchar Delay = 80 msec	
Interchar Delay = 90 msec	

RS-232 Interface Features – cont.

START	
STATE	BARCODE
Disable Software Flow Control	
Enable Software Flow Control	
END	

RS-232 Interface Features – cont.

Host Echo

When enabled, this feature passes all data through the imager to the host as it comes in. This feature is used for applications where “daisy chaining” of RS-232 devices onto the same cable is necessary. If, for example, one of the devices in the chain is a terminal where someone is entering data while another person is simultaneously scanning a bar code requiring transmission to the host, the scanner will wait for the RS-232 channel to be quiet for a specified period of time (set via *RS-232 Host Echo Quiet Interval*). The scanner can be set to observe this delay before sending its data in order to avoid RS-232 transmission conflicts.

Host Echo Quiet Interval

This setting specifies the time interval of RS-232 channel inactivity which must transpire before the imager will break the host echo loop to transmit the bar code data that has just been scanned to the host.

Signal Voltage: Normal/TTL

Specifies whether the RS-232 interface provides TTL levels on the output pins TxD and RTS.

RS-232 Invert







Enables/disables inversion of RS-232 TXD and RXD signals.

RS-232 Interface Features – cont.

START	
STATE	BARCODE
Disable Host Echo	
Enable Host Echo	
Host Echo Quiet Interval = 0msec	
Host Echo Quiet Interval = 10msec	
Host Echo Quiet Interval = 20msec	
Host Echo Quiet Interval = 30msec	
Host Echo Quiet Interval = 40msec	
Host Echo Quiet Interval = 50msec	
Host Echo Quiet Interval = 60msec	
Host Echo Quiet Interval = 70msec	
Host Echo Quiet Interval = 80msec	
Host Echo Quiet Interval = 90msec	

Interface Related Features

RS-232 Interface Features – cont.

START	
STATE	BARCODE
Host Echo Quiet Interval = 100msec	
Signal Voltage: Normal RS-232	
Signal Voltage: TTL	
No TTL Inversion	
Invert TTL	
END	

Beep on ASCII BEL

Enables/disables ability of imager to beep (sound a good read tone) on receiving an ASCII BEL (07 hex).

Beep on Not on File

Select for the host to beep (or not) when a not-on-file (host command) condition is detected by the host.

ACK NAK Options

This enables/disables the ability of the imager to support the RS-232 ACK/NAK protocol. When configured, the imager and/or host sends an “ACK” when it receives data properly, and sends “NAK” when the data is in error. Selections for this option are:

- Disable





Interface Features

- Enable for label transmission — the imager expects an ACK/NAK response from the host when a label is sent
- Enable for host-command acknowledge — the imager will respond with ACK/NAK when the host sends a command
- Enable for label transmission and host-command acknowledge



START	
STATE	BARCODE
Disable Beep on ASCII BEL	
Enable Beep on ASCII BEL	
Disable Beep on Not On File	
Enable Beep on Not On File	
Disable ACK NAK	
Enable ACK NAK for Transmission	
Enable ACK NAK for host-command acknowledge	
Enable ACK NAK for transmission and host-command	
END	

RS-232 Interface Features – cont.

ACK Character

START	
MODE	BARCODE
	<p>Sets the ACK character from the set of ASCII characters or any hex value from 0 to FF. To configure this feature, scan the “START” bar code above to place the unit in Programming Mode, then the “Set ACK Character,” followed by the digits from the Alphanumeric table in Appendix B, Alpha-Numeric Pad representing your desired character. Accept your selection by scanning the “SET” bar code below and finally, exit programming mode by scanning the “END” barcode below.</p> <p>DEFAULT SETTING FOR THIS FEATURE: 06 (0x06)</p>
Set ACK Character	
SET	
END	



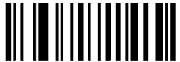

RS-232 Interface Features – cont.
NAK Character

START	
MODE	BARCODE
	<p>Sets the NAK character from the set of ASCII characters or any hex value from 0 to FF. To configure this feature, scan the “START” bar code above to place the unit in Programming Mode, then the “Set NAK Character,” followed by the digits from the Alphanumeric table in Appendix B, Alpha-Numeric Pad representing your desired character. Accept your selection by scanning the “SET” bar code below and finally, exit programming mode by scanning the “END” barcode below.</p> <p>DEFAULT SETTING FOR THIS FEATURE: 21 (0x15)</p>
Set NAK Character	
SET	
END	

RS-232 Interface Features – cont.





Retry on ACK NAK Timeout

Enables/disables retry after the configurable ACK NAK Timeout Value (set in the following feature) has expired.

START	
STATE	BARCODE
Disable Retry on ACK NAK Timeout	
Enable Retry on ACK NAK Timeout	
END	





RS-232 Interface Features – cont.

ACK NAK Timeout Value

START	
MODE	BARCODE
	<p>This item specifies the time the imager will wait for an ACK character from the host following a label transmission.</p> <p>0 = Infinite timeout 1 - 75 = Timeout in 200-millisecond increments</p> <p>To configure this feature, scan the “START” bar code above to place the unit in Programming Mode, then the “Set ACK NAK Timeout Value,” followed by the digits from the Alphanumeric table in Appendix B, Alpha-Numeric Pad representing your desired value. Accept your selection by scanning the “SET” bar code below and finally, exit programming mode by scanning the “END” barcode below</p> <p>DEFAULT SETTING FOR THIS FEATURE: 01</p>
Set ACK NAK Timeout Value	
SET	
END	

RS-232 Interface Features – cont.

ACK NAK Retry Count

START	
MODE	BARCODE
	<p>This feature sets the number of times for the imager to retry a label transmission under a retry condition. 0 = No retry 1 - 254 = Retry for the specified number of times 255 = Retry forever</p> <p>To configure this feature, scan the “START” bar code above to place the unit in Programming Mode, then the “Set ACK NAK Retry Count,” followed by the digits from the Alphanumeric table in Appendix B, Alpha-Numeric Pad representing your desired retry count. Accept your selection by scanning the “SET” bar code below and finally, exit programming mode by scanning the “END” barcode below</p> <p>DEFAULT SETTING FOR THIS FEATURE: 03</p>
Set ACK Nak Retry Count	
SET	
END	

RS-232 Interface Features – cont.





ACK NAK Error Handling

This item specifies the method the imager will use to handle errors detected while waiting to receive the ACK character from the host. Errors include unrecognized host commands and communication errors such as parity or framing errors. Choices are:

00 = Ignore errors detected (recommended setting)

01 = Process error as valid ACK character (risk of lost label data)





02 = Process error as valid NAK character (risk of duplicate label data)

START	
STATE	BARCODE
Ignore Errors Detected	
Process error as valid ACK character	
Process error as valid NAK character	
END	

RS-232 Interface Features – cont.

Transmission Failure Indication

Enables/disables bad-label indication upon transmission failure.





START	
STATE	BARCODE
Disable Transmission Error Indication	
Enable Transmission Error Indication	
END	

IBM-USB Interface Features

IBM-USB Device usage

The IBM-USB protocol allows for the imager to be identified as one of two different types of bar code scanners. Depending on what other scanners you may already have connected to a IBM-USB POS, you may need to change this setting to enable all devices to communicate. Options are:

- Table Top Scanner
- Handheld Scanner

START	
STATE	BARCODE
Configure as Table Top Scanner	
Configure as Handheld Scanner	
END	

IBM

IBM Transmit Labels in Code 39 Format

This feature enables/disables imager's ability to set a symbology identifier for a specified label to Code 39 before transmitting that label data to an IBM host. This applies to: Code 128, Codabar, and Code 93 for IBM USB; Code 128, Codabar, and Code 93 for IBM Port 5B; and Codabar and Code 93 for IBM Port 9B.

START	
STATE	BARCODE
Disable Convert to Code 39	
Enable Convert to Code 39	
END	

Keyboard Wedge/USB Keyboard

As a keyboard interface, the imager supports most popular PCs and IBM terminals. The installation of the wedge is a fairly simple process that doesn't require any changes of software or hardware.











NOTE

All of the options in this section apply to the Keyboard Wedge, however, only Keyboard Layout, Caps Lock State and Control Characters apply to USB Keyboard.

Keyboard Layout

The Keyboard Layout option supports many countries. For details about Keyboard Layout, please refer to your operating system manual.

START	
STATE	BARCODE
USA	
Belgium	
Britain	
Denmark	
France	
Germany	
Italy	
Norway	





Interface Related Features

START	
STATE	BARCODE
Portugal	
Spain	
Sweden	
Switzerland	
Japan 106 Key	
Hungary	
Czech	
Slovakia	
Romania	
END	

Keyboard Wedge/USB Keyboard – cont.

Caps Lock State

Specifies which format the imager sends character data.

START	
STATE	BARCODE
Disable Caps Lock	
Caps Lock "ON"	
Shift Lock "ON"	
END	

Keyboard Wedge/USB Keyboard – cont.

Power-On Simulation



This feature does not apply to the USB Keyboard interface.

NOTE



All PCs check the keyboard status during the power-on Selftest. It is recommended that you enable this function if you are working without a keyboard installation. It simulates keyboard timing and passes the keyboard status to the PC during power-on.

Control Characters

Specifies how the imager transmits ASCII control characters to the host. Choices are:

- Disable Control Characters
- Enable transmission of control characters to host
- Send characters between 00H and 1FH according to a special function-key mapping table. (This is used to send keys that are not in the normal ASCII set; a unique set is provided for each available scancode set. Reference [Appendix C, Keyboard Function Key Mappings.](#))

Keyboard Wedge/USB Keyboard – cont.

START	
STATE	BARCODE
Disable Power-on Simulation	
Enable Power-on Simulation	
Disable Control Characters	
Enable Transmission of Control Characters	
Enable Function Key Mapping	
END	

Keyboard Wedge/USB Keyboard – cont.

Wedge Quiet Interval



This feature does not apply to the USB Keyboard interface.

NOTE

Quiet Interval is the amount of time to look for keyboard activity before the imager breaks the keyboard connection in order to transmit data to the host..

START	
MODE	BARCODE
	Selectable from 00 (no interval) to 255 in 10 msec increments. Use hexadecimal (range: 00 to FF hexadecimal) to set the interval. To configure this feature, scan the "START" bar code above to place the unit in Programming Mode, then the Set Wedge Quiet Interval bar code followed by the digits from the Alphanumeric table in Appendix B, Alpha-Numeric Pad representing your desired length. Accept your selection by scanning the "SET" bar code below and finally, exit programming mode by scanning the "END" barcode below DEFAULT SETTING FOR THIS FEATURE: 01 (10 msec)
Set Wedge Quiet Interval	
SET	
END	





Keyboard Wedge/USB Keyboard – cont.

Intercharacter Delay



This feature does not apply to the USB Keyboard interface.

NOTE

START	
MODE	BARCODE
	<p>This delay is inserted after each data character transmitted. If the transmission speed is too high, the system may not be able to receive all characters. You may need to adjust the delay to make the system work properly. Selectable from 00 to 255 in 10msec increments. Use hexadecimal (range: 00 to FF hexadecimal) to set the delay.</p> <p>To configure this feature, scan the “START” bar code above to place the unit in Programming Mode, then the “Set Intercharacter Delay,” followed by the digits from the Alphanumeric table in Appendix B, Alpha-Numeric Pad representing your desired length. Accept your selection by scanning the “SET” bar code below and finally, exit programming mode by scanning the “END” barcode below</p> <p style="text-align: center;">DEFAULT SETTING FOR THIS FEATURE: 00 (No Delay)</p>
Set Intercharacter Delay	
SET	
END	

Wand Emulation

Supported Symbologies

The Wand Emulation interface will transmit bar code data as a wand device would. This interface will transmit the following bar code symbologies:

- UPC/EAN
- UPC/EAN with add-ons
- Code 39
- Full ASCII Code 39
- Interleaved 2 of 5
- Codabar
- Code 128

All other bar code symbology types read by the scanner will be transmitted as Code 128.

Wand Emulation Bar Code Format

The following format settings are required for the wand emulation interface. These settings have been pre-configured at the factory for Wand Emulation scanners.

- UPC-A bar codes must include all 12 digits.
- UPC-E bar codes must contain 8 digits, including a system digit, 6 data digits, and the check digit.
- EAN-13 bar codes must have all 13 digits.
- EAN-8 bar codes must include all 8 digits.
- Code 39, Code 39 Full ASCII, and Pharmacode 39 bar codes must NOT contain start / stop characters.
- Codabar bar codes must include the start / stop characters, presented in the ABCD format.
- Interleaved 2 of 5 bar codes must have an even number of digits.
- The Prefix, Suffix, and Code ID must be disabled for all symbologies

Wand Emulation – cont.

Bar/Space Polarity

Low/High — Black will be transmitted as a low voltage level (0V) and space as high level (+5).





High/Low — Black will be transmitted as a high voltage level (+5) and space as low level (0V).

Initial Polarity

The idle polarity of the wand decode device can be set with the following options:

High voltage level (+5)

Low voltage level (0V).

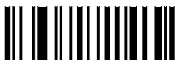
START	
STATE	BARCODE
Bar/Space = Low/High	
Bar/Space = High/Low	
Initial Polarity = High Voltage (+5V)	
Initial Polarity = Low Voltage (0V)	
END	

Wand Emulation – cont.

Signal Speed







The speed of the transmission can be set. This selects the width of the minimum narrow bar.

330 microseconds

660 microseconds

Transmit Trailing Noise

The transmission of noise pulses after the label may be enabled or disabled.

START	
STATE	BARCODE
Signal Speed = 330mS	
Signal Speed = 660mS	
Disable Trailing Noise	
Enable Trailing Noise	
END	

Wand Emulation – cont.

Transmit Leading Noise

The transmission of noise pulses before the bar code may be enabled or disabled.







Symbology Conversion

Wand Emulation can convert all bar codes to a single symbology. Choices are:

No Conversion

Convert to Code 39 / Code 39 Full ASCII

Convert to Code 128

START	
STATE	BARCODE
Disable Leading Noise	
Enable Leading Noise	
No Symbology Conversion	
Convert to C39/ C39 Full ASCII	
Convert to C128	
END	

NOTES

Chapter 5

Data Editing

Data Editing Overview



It is not recommended to use these features with IBM 46xx or IBM interfaces.

CAUTION

When a bar code is scanned, additional information can be sent to the host computer along with the bar code data. This combination of bar code data and supplementary user-defined data is called a “message string.” The features in this chapter can be used to build specific user-defined data into a message string.

There are several types of selectable data characters that can be sent before, after, and even between scanned data. You can specify if they should be sent with all symbologies, or only with specific symbologies. [Figure 5-1](#) shows the available elements you can add to a message string:

Figure 5-1. Breakdown of a Message String

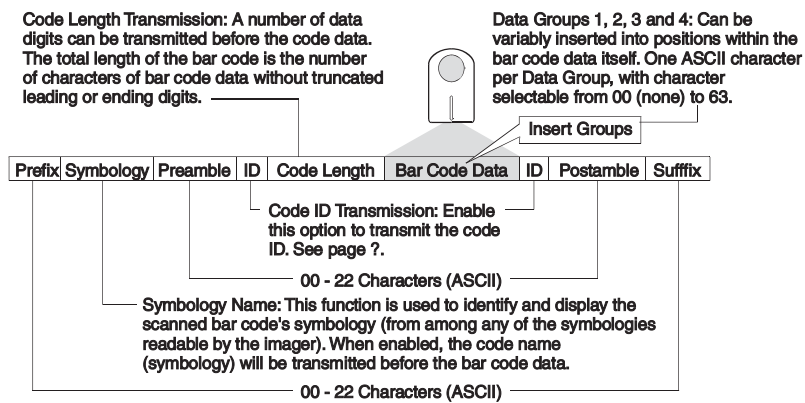

Data Editing

Please Keep In Mind...

- Modifying a message string is not a mandatory requirement. Data editing is sophisticated feature allowing highly customizable output for advanced users. Factory default settings for data editing is typically set to NONE.
- A prefix or suffix may be applied to one symbology (reference the [Symbologies](#) chapter for these settings) or across all symbologies (set via the features in this chapter).
- You can add any prefix or suffix from [Appendix A, ASCII Conversion Chart](#), plus Code I.D./AIM I.D.
- Several entries for several symbologies can be strung together at one time.
- Enter prefixes and suffixes in the order in which you want them to appear on the output.

Prefix/Suffix

Up to 22 ASCII characters may be added as a prefix (in a position before the bar code data) and/or as a suffix (in a position following the bar code data) as indicated in [Figure 5-2](#).

Figure 5-2. Prefix and Suffix Positions

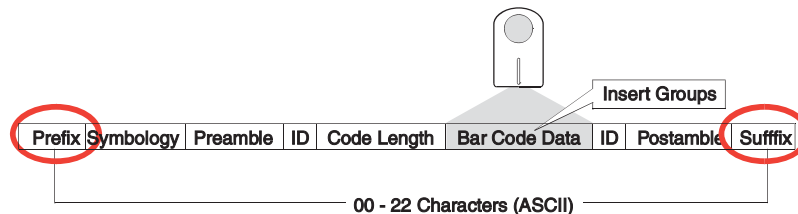

Prefix/Suffix – continued





Example: Setting a Prefix

In this example, we'll set a prefix for all symbologies.

1. Determine which ASCII character(s) are to be added to scanned bar code data. In this example, we'll add a dollar sign ('\$') as a prefix.
2. Scan the START bar code.
3. Scan the SET PREFIX CHARACTER(S) bar code.
4. Reference [Appendix A, ASCII Conversion Chart](#), to find the hex value assigned to the desired character. The corresponding hex number for the '\$' character is 24. To enter this selection code, scan the '2' and '4' bar codes from [Appendix B, Alpha-Numeric Pad](#).
5. Scan the SET bar code to accept the digits scanned.
6. Scan the END bar code to exit Programming Mode.
7. The resulting message string would appear as follows:

Scanned bar code data: 12345
Resulting message string output: \$12345

Prefix/Suffix – continued

START	
MODE	BARCODE
	<p>Sets up to 22 characters each from the set of ASCII characters or any hex value from 0 to FF. To configure this feature, scan the “START” bar code above to place the unit in Programming Mode, then the “Set Prefix” or “Set Suffix,” followed by the digits from the Alphanumeric table in Appendix B, Alpha-Numeric Pad representing your desired character(s). Reference the section, Example: Setting a Prefix, for more information. Accept your selection by scanning the “SET” bar code below and finally, exit programming mode by scanning the “END” barcode below. DEFAULT SETTING FOR THIS FEATURE: 00 (None)</p>
Set Prefix	
Set Suffix	
SET	
END	

Preamble/Postamble

Similar to the Prefix/Suffix, up to 22 ASCII characters may be added as a preamble (in a position before the bar code data) and/or as a postamble (in a position following the bar code data) as indicated in [Figure 5-3](#).

Figure 5-3. Preamble and Postamble Positions

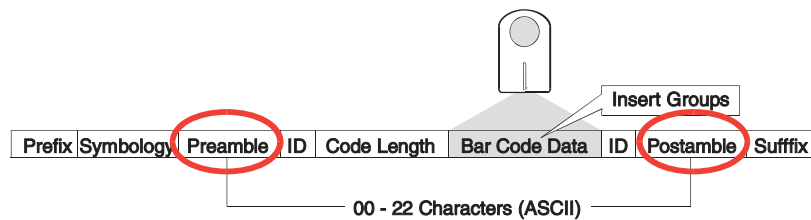







Example: Setting a Postamble

In this example, we'll set a postamble for all symbologies.

1. Determine which ASCII character(s) are to be added to scanned bar code data. In this example, we'll add the percent character ('%') as a postamble.
2. Scan the START bar code.
3. Scan the SET POSTAMBLE CHARACTER(S) bar code.
4. Reference [Appendix A, ASCII Conversion Chart](#), to find the hex value assigned to the desired character. The corresponding hex number for the '%' character is 25. To enter this selection code, scan the '2' and '5' bar codes from [Appendix B, Alpha-Numeric Pad](#).
5. Scan the SET bar code to accept the digits scanned.
6. Scan the TRANSMIT POSTAMBLE bar code to allow transmission of the postamble.
7. Scan the END bar code to exit Programming Mode.
8. The resulting message string would appear as follows:

Scanned bar code data: 12345
 Resulting message string output: 12345%

Preamble/Postamble – continued

START	
MODE	BARCODE
	<p>Sets up to 22 characters each from the set of ASCII characters or any hex value from 0 to FF. To configure this feature, scan the “START” bar code above to place the unit in Programming Mode, then the “SET PREAMBLE” or “SET POSTAMBLE,” followed by the digits from the Alphanumeric table in Appendix B, Alpha-Numeric Pad representing your desired character(s). Reference the section, Example: Setting a Postamble, for more information. Accept your selection by scanning the “SET” bar code below, scan the “TRANSMIT PREAMBLE” (or “TRANSMIT POSTAMBLE” as applicable) bar code, then finally, exit programming mode by scanning the “END” bar code below.</p> <p>DEFAULT SETTING FOR THIS FEATURE: 00 (None)</p>
Set Preamble	
Disable Preamble	
Transmit Preamble	
Set Postamble	
Disable Postamble	

Data Editing Overview

START	
MODE	BARCODE
Transmit Postamble	
SET	
END	

Symbology, I.D. and Code Length

Useful information, such as the scanned bar code's symbology type, code I.D. and character length can all be variously added to the message string. The following are descriptions for each of these elements:

Symbology — This function is used to identify and display the scanned bar code's symbology name (from among any of the symbologies readable by the imager). When enabled, the code name (symbology) will be transmitted in a position before the bar code data.

Code I.D. — The Code I.D. is an alpha-numeric code representing the bar code (symbology) type. It can be appended previous to and/or following the transmitted bar code data depending upon how this feature is enabled.



NOTE

An extra step is required in enabling this feature. Selection of Code I.D. Position (either before or after bar code data) must be made PRIOR to selecting either Proprietary or AIM I.D.

In addition to message string positioning (before or after bar code data), options for this feature include:

- Disable
- Proprietary I.D. — Symbologies are identified by an associated alpha-numeric code developed by the manufacturer.
- AIM I.D. — Symbologies are identified by a standardized alpha-numeric code list established by AIM (Association for Automatic Identification and Mobility).





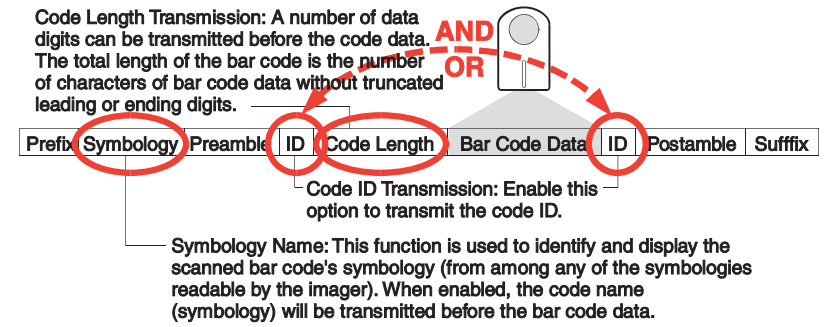





Code Length — When enabled, this feature will calculate the total character length of the scanned bar code (minus truncated leading or ending digits) and transmit this information just previous to the actual scanned data.

Figure 5-4. Code Data Elements



Data Editing

Symbology, I.D. and Code Length – continued

START	
MODE	BARCODE
Disable Symbology Name	
Enable Symbology Name	
Code I.D. Position: Before Bar Code Data	
Code I.D. Position: After Bar Code Data	
Code I.D. Transmission: Disable	
Code I.D. Transmission: Proprietary I.D.	
Code I.D. Transmission: AIM I.D.	
Disable Code Length Transmission	
Enable Code Length Transmission	
END	

Data Group Characters

Options are available to insert characters in up to four positions between the scanned bar code data. This is accomplished by selecting the position and up to 22 ASCII characters for each for Data Group 1, Data Group 2, Data Group 3 and Data Group 4 settings.



NOTE

The options in this chapter set **Data Group Characters** globally for all symbologies. If you wish to enable this feature only for a single symbology, turn to the options for that symbology in the [Symbologies](#) chapter.

Example: Setting Position and Characters for Data Group 1

In this example, we'll set a position and select two characters for Data Group 1.

Select Data Group 1 Position

1. Determine which position in the bar code data you wish to insert character(s). In this example, we'll select a position three characters from the left within the bar code data.



NOTE

Make sure the insertion position you select is not greater than the total number of bar code characters scanned; otherwise, the Data Group character(s) will not be inserted.

2. Scan the START bar code.
3. Scan the SET DATA GROUP 1 POSITION bar code.
4. In this step, we select the three-spaces-from-the-left position in which to place the characters we'll select later. Scan first the 0 (zero) bar code, then the 3 bar code from the numeric digit bar codes provided in [Appendix B, Alpha-Numeric Pad](#).
5. Scan the SET bar code to accept the digits scanned.
6. Scan the END bar code to exit Programming Mode.

Select Data Group 1 Character(s)

1. Determine which ASCII character(s) is/are to be added to scanned bar code data. In this example, we'll add two characters: + (the plus sign) and # (the pound, or number sign).





Data Editing

2. Scan the START bar code.
3. Next, scan the SET DATA GROUP 1 CHARACTER bar code.
4. Reference [Appendix A, ASCII Conversion Chart](#), to find the hex value assigned to each desired character. The corresponding hex number for the '+' character is 2B; for the '#' sign, the hex equivalent is 23. To enter the selection code, scan first the '2' and 'B' bar codes from [Appendix B, Alpha-Numeric Pad](#), then the '2' and '3' bar codes.
5. Scan the SET bar code to accept the digits scanned.
6. Scan the END bar code to exit Programming Mode.
7. Data Group Characters are configured individually for each symbology type, enabling or disabling the Data Groups you've created using the options provided in the [Symbologies](#) chapter.









The resulting message string after completing the steps above would appear as follows:

Scanned bar code data: 12345
 Resulting message string output: 12+#345

Data Group Characters – continued

START	
MODE	BARCODE
	Sets position and up to 22 ASCII characters each or any hex value from 0 to 64. To configure this feature, reference the section, Example: Setting Position and Characters for Data Group 1 for more information. DEFAULT SETTING FOR THIS FEATURE: 00 (None)
Set Group 1 Position	
Set Group 1 Character(s)	
Set Group 2 Position	

Data Group Characters – continued

START	
MODE	BARCODE
Set Group 2 Character(s)	
Set Group 3 Position	
Set Group 3 Character(s)	
Set Group 4 Position	
Set Group 4 Character(s)	
SET	
END	

Data Editing





Case Conversion

This feature can convert scanned bar code data to either all lower case or all upper case characters.



Case conversion affects ONLY scanned bar code data, and does not affect Code I.D., Preamble, Postamble, or other appended data.

NOTE

START	
MODE	BARCODE
Disable	
Convert to Upper Case	
Convert to Lower Case	
END	

Chapter 6

Symbologies

The imager supports the following symbologies (bar code types). Options for each symbology are included in this chapter.

- UPC-A
- UPC-E
- EAN-13
- EAN-8
- GTIN
- RSS-14
- RSS Expanded
- RSS Limited
- Code 39
- Pharmacode 39
- Code 128
- EAN-128
- Interleaved 2 of 5
- Industrial 2 of 5
- Matrix 2 of 5 (Eur)
- Codabar
- Code 93
- Code 11
- MSI/Plessey
- UK-Plessey
- Telepen
- Standard 2 of 5
- Code 16K
- China Post

The PDF417 version of the imager will additionally support these symbologies.:

- PDF 417
- Micro PDF 417
- EAN UCC Composite

Factory Defaults — are indicated in bold text and are highlighted with yellow throughout this section.

UPC-A

The following options apply to the UPC-A symbology.

Disable/Enable UPC-A

When disabled, the imager will not read UPC-A bar codes.









Checksum Transmission

Enable this option to transmit the checksum along with UPC-A bar code data.

Expand UPC-A to EAN-13

Enable this option to add a leading zero to a UPC-A bar code which 'expands' the data to the EAN-13 data format. Selecting this feature also changes the symbology ID to match those required for EAN-13.

UPC-A – continued

START	
STATE	BARCODE
Disable UPC-A	
Enable UPC-A	
Don't Send Checksum	
Send Checksum	
No Expansion	
Expand UPC-A to EAN-13	
END	

UPC-A — continued

Truncate Leading/Ending

The leading or ending digits of bar code data characters can be truncated. Select from 00 (no truncation) to 15.



NOTE

The imager will beep instead of reading anything when the truncate value is more than the bar code data digits or the truncate leading value overlaps the truncate ending value.

START	
MODE	BARCODE
<p>Sets from 00 to 15 characters to truncate from either the leading or ending characters of scanned bar code data. To configure this feature, scan the “START” bar code above to place the unit in Programming Mode, then the SET TRUNCATION: LEADING or SET TRUNCATION: ENDING, followed by the digits from the Alphanumeric table in Appendix B, Alpha-Numeric Pad representing the desired quantity of digits to truncate from the message string. Accept your selection by scanning the “SET” bar code below and finally, exit programming mode by scanning the “END” barcode below.</p> <p>DEFAULT SETTING FOR THIS FEATURE: 00 (None)</p>	
Set Truncation: Leading	
Set Truncation: Ending	
SET	
END	

UPC-A – continued

Code I.D. Selection

The Code I.D. for this symbology consists of one or two user-selectable ASCII characters. It can be appended previous to or following the transmitted UPC-A bar code data depending on how this feature is enabled.

Example: Setting the UPC-A Code I.D.

To configure this feature:

1. Determine which character(s) you would like to use to represent the UPC-A symbology. Reference [Appendix A, ASCII Conversion Chart](#), to find the corresponding hex values for your chosen character(s). In this example we'll set a Code I.D. of "A" to represent UPC-A. The value from the table corresponding to 'A' is 41. This value will be used in a step to follow.
2. Scan the START bar code
3. Scan the SET UPC-A CODE I.D. bar code.
4. Turn to [Appendix B, Alpha-Numeric Pad](#) and scan the bar codes '4' and '1' (the value 41 determined in an earlier step to represent a Code I.D. of 'A').
5. Scan the SET bar code to accept the digits scanned.
6. Turn to the [Data Editing](#) chapter and scan the CODE ID POSITION: BEFORE BAR CODE DATA label.

**NOTE**





Features configured using the [Data Editing](#) chapter are universal and will affect all symbologies.

7. Scan the END bar code to exit Programming Mode.
8. The resulting message string for scanned UPC-A labels would appear as follows:

Scanned bar code data: 0123456789123

Resulting message string output: A0123456789123

UPC-A — continued

START	
STATE	BARCODE
Set UPC-A Code I.D. Character(s)	 <p>DEFAULT SETTING FOR THIS FEATURE: A (41 hex)</p> <p>Select 0000 to disable Code ID for this symbology only.</p>
SET	
END	

UPC-A — continued

UPC-A Data Group Characters

Once you've pre-set your desired Data Group Characters¹ using the [Data Group Characters](#) feature found in [Chapter 5, Data Editing](#), you can choose to output up to two of those pre-sets whenever a UPC-A bar code is scanned.

**NOTE**

The options in this section set Data Group Characters for the UPC-A symbology ONLY. If you wish to enable this feature for additional symbologies, turn to the options in the section specific to the other symbology(s).

To set this feature:

1. Determine which Data Group pre-set(s) to output. You can select up to two from the following:

Data Group 1 * Data Group 2 * Data Group 3 * Data Group 4





For example, your choice might be Data Group 2 only; Data Groups 1 and 3; Data Groups 3 and 4; or no Data Groups.

2. Scan the START bar code to place the imager in Programming Mode.
3. Scan the SET UPC-A DATA GROUP CHARACTERS bar code.
4. Turn to [Appendix B, Alpha-Numeric Pad](#) and scan the digits representing the Data Group designation(s) chosen in the first step above. A digit of value zero (0) selects “no group.” For example, scanning 3 and 0 would output only the character(s) set for Data Group 3 whenever a UPC-A bar code was scanned. Scanning digits 1 and 2 would output both Data Groups 2 and 3. To select no Data Groups at all, scan 0, then 0 again.
5. Scan the SET bar code to accept the digits scanned.
6. Scan the END bar code to exit Programming Mode.

1. In that chapter, you can select which character(s) and position(s) to place Data Characters within scanned data output.

Symbologies

UPC-A — continued

START	
STATE	BARCODE
Set UPC-A Data Group(s)	 DEFAULT SETTING FOR THIS FEATURE: None (00)
SET	
END	

UPC-A — continued

Add-ons

Add-ons (or supplemental characters) are commonly added to the end of UPC-A bar codes. The imager will read the add-ons if they are enabled and in the field of view. Three add-on types are supported: 2-digit, 5-digit and UCC/EAN 128. Supported options are:

None — This option directs the imager to ignore add-on portion of a UPC-A bar code but still read the main portion of the bar code.

2 Digits — The imager will read 2-digit add-ons with the UPC-A label.

5 Digits — The imager will read 5-digit add-ons with the UPC-A label.

2 and 5 Digits — The imager will read 2- and 5-digit add-ons with the UPC-A label.











UCC/EAN 128 — The imager will read UCC/EAN 128 add-ons with the UPC-A label.

2-Digit & UCC/EAN 128 — The imager will read 2-digit and UCC/EAN 128 add-ons with the UPC-A label.

5-Digit & UCC/EAN 128 — The imager will read 5-digit and UCC/EAN 128 add-ons with the UPC-A label.

All — The imager will read 2-digit, 5-digit and UCC/EAN 128 add-ons with the UPC-A label.

UPC-A — continued

START	
STATE	BARCODE
None	
2-Digits	
5-Digits	
2 & 5-Digits	
UCC/EAN 128	
2-Digit & UCC/ EAN 128	
5-Digit & UCC/ EAN 128	
All	
END	

UPC-E

The following options apply to the UPC-E symbology.

Disable/Enable UPC-E

When disabled, the imager will not read UPC-E bar codes.

Checksum Transmission

Enable this option to transmit the checksum along with UPC-E bar code data.

Truncate/Expand

None — Turns off the truncation/expansion features listed below.



NOTE











Has no affect on the [Truncate Leading/Ending](#) feature. To turn it off, set leading/ending values to 00.

Truncate NSD — The Number System Digit (NSD) which is usually a zero (0) in the leading position can be truncated (excluded) from scanned bar code data.

Expand UPC-E to EAN13 — Adds a leading zero to a UPC-E bar code which 'expands' the data to the EAN-13 data format. Selecting this feature also changes the symbology ID to match those required for EAN-13.

Expand to UPC-E to UPC-A — Adds a leading zero to a UPC-E bar code which 'expands' the data to the EAN-13 data format. Selecting this feature also changes the symbology ID to match those required for EAN-13.

UPC-E — continued

START	
STATE	BARCODE
Disable UPC-E	
Enable UPC-E	
Don't Send Checksum	
Send Checksum	
Truncate NSD/ Expand to EAN-13: NONE	
Truncate NSD	
Expand UPC-E to EAN-13	
Expand UPC-E to UPC-A	
END	

UPC-E – continued

Truncate Leading/Ending

The leading or ending digits of bar code data characters can be truncated. Select from 00 (no truncation) to 15.



NOTE

The imager will beep instead of reading anything when the truncate value is more than the bar code data digits or the truncate leading value overlaps the truncate ending value.

START	
MODE	BARCODE
<p>Sets from 00 to 15 characters to truncate from either the leading or ending characters of scanned bar code data. To configure this feature, scan the “START” bar code above to place the unit in Programming Mode, then the SET TRUNCATION: LEADING or SET TRUNCATION: ENDING, followed by the digits from the Alpha-numeric table in Appendix B, Alpha-Numeric Pad representing the desired quantity of digits to truncate from the message string. Accept your selection by scanning the “SET” bar code below and finally, exit programming mode by scanning the “END” barcode below.</p> <p>DEFAULT SETTING FOR THIS FEATURE: 00 (None)</p>	
Set Truncation: Leading	
Set Truncation: Ending	
SET	
END	

UPC-E — continued

Code I.D. Selection

The Code I.D. for this symbology consists of one or two user-selectable ASCII characters. It can be appended previous to or following the transmitted UPC-E bar code data depending on how this feature is enabled.

Example: Setting the UPC-E Code I.D.

To configure this feature:

1. Determine which character(s) you would like to use to represent the UPC-E symbology. Reference [Appendix A, ASCII Conversion Chart](#), to find the corresponding hex values for your chosen character(s). In this example we'll set a Code I.D. of "E" to represent UPC-E. The value from the table corresponding to 'E' is 45. This value will be used in a step to follow.
2. Scan the START bar code
3. Scan the SET UPC-E CODE I.D. bar code.
4. Turn to [Appendix B, Alpha-Numeric Pad](#) and scan the bar codes '4' and '5' (the value 45 determined in an earlier step to represent a Code I.D. of 'E').
5. Scan the SET bar code to accept the digits scanned.
6. Turn to the [Data Editing](#) chapter and scan the CODE ID POSITION: BEFORE BAR CODE DATA label.



NOTE



Features configured using the [Data Editing](#) chapter are universal and will affect all symbologies.

7. Scan the END bar code to exit Programming Mode.
8. The resulting message string for scanned UPC-E labels would appear as follows:

Scanned bar code data: 01234565

Resulting message string output: E01234565

UPC-E — continued

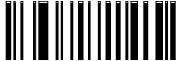
START	
STATE	BARCODE
Set UPC-E Code I.D. Character(s)	 DEFAULT SETTING FOR THIS FEATURE: E (45 hex) Select 0000 to disable Code ID for this symbology only.
SET	
END	

UPC-E — continued

UPC-E Data Group Characters

Once you've pre-set your desired Data Group Characters¹ using the [Data Group Characters](#) feature found in [Chapter 5, Data Editing](#), you can choose to output up to two of those pre-sets whenever a UPC-E bar code is scanned.



NOTE





The options in this section set Data Group Characters for the UPC-E symbology ONLY. If you wish to enable this feature for additional symbologies, turn to the options in the section specific to the other symbology(s).

To set this feature:

1. Determine which Data Group pre-set(s) to output. You can select up to two from the following:
Data Group 1 * Data Group 2 * Data Group 3 * Data Group 4
For example, your choice might be Data Group 2 only; Data Groups 1 and 3; Data Groups 3 and 4; or no Data Groups.
2. Scan the START bar code to place the imager in Programming Mode.
3. Scan the SET UPC-E DATA GROUP CHARACTERS bar code.
4. Turn to [Appendix B, Alpha-Numeric Pad](#) and scan the digits representing the Data Group designation(s) chosen in the first step above. A digit of value zero (0) selects “no group.” For example, scanning 3 and 0 would output only the character(s) set for Data Group 3 whenever a UPC-E bar code was scanned. Scanning digits 1 and 2 would output both Data Groups 2 and 3. To select no Data Groups at all, scan 0, then 0 again.
5. Scan the SET bar code to accept the digits scanned.
6. Scan the END bar code to exit Programming Mode.

1. In that chapter, you can select which character(s) and position(s) to place Data Characters within scanned data output.

UPC-E — continued

START	
STATE	BARCODE
Set UPC-E Data Group(s)	 DEFAULT SETTING FOR THIS FEATURE: None (00)
SET	
END	

UPC-E — continued

Add-ons

Add-ons (or supplemental characters) are commonly added to the end of UPC-E bar codes. The imager will read the add-ons if they are enabled and in the field of view. Three add-on types are supported: 2-digit, 5-digit and UCC/EAN 128. Supported options are:

None — This option directs the imager to ignore add-on portion of a UPC-E bar code but still read the main portion of the bar code.

2 Digits — The imager will read 2-digit add-ons with the UPC-E label.

5 Digits — The imager will read 5-digit add-ons with the UPC-E label.

2 and 5 Digits — The imager will read 2- and 5-digit add-ons with the UPC-E label.











UCC/EAN 128 — The imager will read UCC/EAN 128 add-ons with the UPC-E label.

2-Digit & UCC/EAN 128 — The imager will read 2-digit and UCC/EAN 128 add-ons with the UPC-E label.

5-Digit & UCC/EAN 128 — The imager will read 5-digit and UCC/EAN 128 add-ons with the UPC-E label.

All — The imager will read 2-digit, 5-digit and UCC/EAN 128 add-ons with the UPC-E label.

UPC-E — continued

START	
STATE	BARCODE
None	
2-Digits	
5-Digits	
2 & 5-Digits	
UCC/EAN 128	
2-Digit & UCC/ EAN 128	
5-Digit & UCC/ EAN 128	
All	
END	

Symbologies

EAN-13

The following options apply to the EAN-13 symbology.

Disable/Enable EAN-13

When disabled, the imager will not read EAN-13 bar codes.

Checksum Transmission

Enable this option to transmit the checksum along with EAN-13 bar code data.









ISBN/ISSN

When enabled, this feature truncates the leading three digits from labels that contain ISBN (International Standard Book Number) and ISSN (International Standard Serial Number) numbers. These two codes are used for books and magazines. Labels with ISBN codes start with "978" and those with ISSN codes start with a leading "977".

Examples:

Bar code data:	"9789572222720"
Output:	"9572222724"
Bar code data:	"97710192480"
Output:	"10192480"

EAN-13 — continued

START	
STATE	BARCODE
Disable EAN-13	
Enable EAN-13	
Don't Send Checksum	
Send Checksum	
Disable ISBN/ISSN	
Enable ISBN/ISSN	
END	

EAN-13 — continued

ISBN ID Setting

Sets the Code ID used for labels that are translated to ISBN/ISSN numbers. The Code I.D. for this symbology consists of one or two user-selectable ASCII characters. It can be appended previous to or following the transmitted bar code data depending on how this feature is enabled.

Example: Setting the ISBN ID

To configure this feature:

1. Determine which character(s) you would like to use to represent ISBN/ISSN translated labels. Reference [Appendix A, ASCII Conversion Chart](#), to find the corresponding hex values for your chosen character(s). In this example we'll set a Code I.D. of "I" to represent ISBN/ISSN. The value from the table corresponding to 'I' is 49. This value will be used in a step to follow.
2. Scan the START bar code
3. Scan the SET ISBN CODE I.D. bar code.
4. Turn to [Appendix B, Alpha-Numeric Pad](#) and scan the bar codes '4' and '9' (the value 49 determined in an earlier step to represent a Code I.D. of 'I').
5. Scan the SET bar code to accept the digits scanned.
6. Turn to the [Data Editing](#) chapter and scan the CODE ID POSITION: BEFORE BAR CODE DATA label.



NOTE





Features configured using the [Data Editing](#) chapter are universal and will affect all symbologies.

7. Scan the END bar code to exit Programming Mode.
8. The resulting message string for converted ISBN/ISSN labels would appear as follows:

Scanned bar code data: 97801234565

Resulting message string output: I97801234565

EAN-13 — continued

START	
STATE	BARCODE
Set ISBN Code I.D. Character(s)	 <p>DEFAULT SETTING FOR THIS FEATURE: I (49 hex)</p> <p>Select 0000 to disable Code ID for this symbology only.</p>
SET	
END	

EAN-13 — continued





Truncate Leading/Ending

The leading or ending digits of bar code data characters can be truncated. Select from 00 (no truncation) to 15.



NOTE

The imager will beep instead of reading anything when the truncate value is more than the bar code data digits or the truncate leading value overlaps the truncate ending value.

START	
MODE	BARCODE
<p>Sets from 00 to 15 characters to truncate from either the leading or ending characters of scanned bar code data. To configure this feature, scan the “START” bar code above to place the unit in Programming Mode, then the SET TRUNCATION: LEADING or SET TRUNCATION: ENDING, followed by the digits from the Alpha-numeric table in Appendix B, Alpha-Numeric Pad representing the desired quantity of digits to truncate from the message string. Accept your selection by scanning the “SET” bar code below and finally, exit programming mode by scanning the “END” barcode below.</p> <p>DEFAULT SETTING FOR THIS FEATURE: 00 (None)</p>	
Set Truncation: Leading	
Set Truncation: Ending	
SET	
END	

EAN-13 — continued

Code I.D. Selection

The Code I.D. for this symbology consists of one or two user-selectable ASCII characters. It can be appended previous to or following the transmitted EAN-13 bar code data depending on how this feature is enabled.

Example: Setting the EAN-13 Code I.D.

To configure this feature:

1. Determine which character(s) you would like to use to represent the EAN-13 symbology. Reference [Appendix A, ASCII Conversion Chart](#) to find the corresponding hex values for your chosen character(s). In this example we'll set a Code I.D. of "F" to represent EAN-13. The hex value from the table corresponding to 'F' is 46. This value will be used in a step to follow.
2. Scan the START bar code
3. Scan the SET EAN-13 CODE I.D. bar code.
4. Turn to [Appendix B, Alpha-Numeric Pad](#) and scan the bar codes '4' and '6' (the value determined in an earlier step).
5. Scan the SET bar code to accept the digits scanned.
6. Turn to the [Data Editing](#) chapter and scan the CODE ID POSITION: BEFORE BAR CODE DATA label.

**NOTE**





Features configured using the [Data Editing](#) chapter are universal and will affect all symbologies.

7. Scan the END bar code to exit Programming Mode.
8. The resulting message string for scanned EAN-13 labels would appear as follows:

Scanned bar code data: 023456788122

Resulting message string output: F023456788122

EAN-13 – continued

START	
STATE	BARCODE
Set EAN-13 Code I.D. Character(s)	 DEFAULT SETTING FOR THIS FEATURE: F (46 hex) Select 0000 to disable Code ID for this symbology only.
SET	
END	

EAN-13 – continued

EAN-13 Data Group Characters

Once you've pre-set your desired Data Group Characters¹ using the [Data Group Characters](#) feature found in [Chapter 5, Data Editing](#), you can choose to output up to two of those pre-sets whenever an EAN-13 bar code is scanned.



NOTE

The options in this section set Data Group Characters for the EAN-13 symbology ONLY. If you wish to enable this feature for additional symbologies, turn to the options in the section specific to the other symbology(s).





To set this feature:

1. Determine which Data Group pre-set(s) to output. You can select up to two from the following:
 Data Group 1 * Data Group 2 * Data Group 3 * Data Group 4
 For example, your choice might be Data Group 2 only; Data Groups 1 and 3; Data Groups 3 and 4; or no Data Groups.
2. Scan the START bar code to place the imager in Programming Mode.
3. Scan the SET EAN-13 DATA GROUP CHARACTERS bar code.
4. Turn to [Appendix B, Alpha-Numeric Pad](#) and scan the digits representing the Data Group designation(s) chosen in the first step above. A digit of value zero (0) selects “no group.” For example, scanning 3 and 0 would output only the character(s) set for Data Group 3 whenever an EAN-13 bar code was scanned. Scanning digits 1 and 2 would output both Data Groups 2 and 3. To select no Data Groups at all, scan 0, then 0 again.
5. Scan the SET bar code to accept the digits scanned.
6. Scan the END bar code to exit Programming Mode.

1. In that chapter, you can select which character(s) and position(s) to place Data Characters within scanned data output.

Symbologies

EAN-13 – continued

START	
STATE	BARCODE
Set EAN-13 Data Group(s)	 DEFAULT SETTING FOR THIS FEATURE: None (00)
SET	
END	

EAN-13 — continued

Add-ons

Add-ons (or supplemental characters) are commonly added to the end of EAN-13 bar codes. The imager will read the add-ons if they are enabled and in the field of view. Three add-on types are supported: 2-digit, 5-digit and UCC/EAN 128. Supported options are:

None — This option directs the imager to ignore add-on portion of a EAN-13 bar code but still read the main portion of the bar code.

2 Digits — The imager will read 2-digit add-ons with the EAN-13 label.

5 Digits — The imager will read 5-digit add-ons with the EAN-13 label.

2 and 5 Digits — The imager will read 2- and 5-digit add-ons with the EAN-13 label.











UCC/EAN 128 — The imager will read UCC/EAN 128 add-ons with the EAN-13 label.

2-Digit & UCC/EAN 128 — The imager will read 2-digit and UCC/EAN 128 add-ons with the EAN-13 label.

5-Digit & UCC/EAN 128 — The imager will read 5-digit and UCC/EAN 128 add-ons with the EAN-13 label.

All — The imager will read 2-digit, 5-digit and UCC/EAN 128 add-ons with the EAN-13 label.

EAN-13 – continued

START	
STATE	BARCODE
None	
2-Digits	
5-Digits	
2 & 5-Digits	
UCC/EAN 128	
2-Digit & UCC/ EAN 128	
5-Digit & UCC/ EAN 128	
All	
END	

EAN-8







The following options apply to the EAN-8 symbology.

Disable/Enable EAN-8

When disabled, the imager will not read EAN-8 bar codes.

Checksum Transmission

Enable this option to transmit the checksum along with EAN-8 bar code data.

START	
STATE	BARCODE
Disable EAN-8	
Enable EAN-8	
Don't Send Checksum	
Send Checksum	
END	

EAN-8 — continued

Truncate/Expand

None — Turns off the truncation/expansion features listed below.







NOTE

Has no affect on the **Truncate Leading/Ending** feature. To turn it off, set leading/ending values to 00.

Truncate NSD — The Number System Digit (NSD) which is usually a zero (0) in the leading position can be truncated (excluded) from scanned bar code data.

Expand EAN-8 to EAN-13 — Expands EAN-8 data to the EAN-13 data format. Selecting this feature also changes the symbology ID to match those required for EAN-13.

START	
STATE	BARCODE
Truncate NSD/ Expand to EAN-13: NONE	
Truncate NSD	
Expand to EAN-13	
END	

EAN-8 – continued

Truncate Leading/Ending

The leading or ending digits of bar code data characters can be truncated. Select from 00 (no truncation) to 15.



NOTE

The imager will beep instead of reading anything when the truncate value is more than the bar code data digits or the truncate leading value overlaps the truncate ending value.

START	
MODE	BARCODE
<p>Sets from 00 to 15 characters to truncate from either the leading or ending characters of scanned bar code data. To configure this feature, scan the “START” bar code above to place the unit in Programming Mode, then the SET TRUNCATION: LEADING or SET TRUNCATION: ENDING, followed by the digits from the Alpha-numeric table in Appendix B, Alpha-Numeric Pad representing the desired quantity of digits to truncate from the message string. Accept your selection by scanning the “SET” bar code below and finally, exit programming mode by scanning the “END” barcode below.</p> <p>DEFAULT SETTING FOR THIS FEATURE: 00 (None)</p>	
Set Truncation: Leading	
Set Truncation: Ending	
SET	
END	

EAN-8 — continued

Code I.D. Selection

The Code I.D. for this symbology consists of one or two user-selectable ASCII characters. It can be appended previous to or following the transmitted EAN-8 bar code data depending on how this feature is enabled.

Example: Setting the EAN-8 Code I.D.

To configure this feature:

1. Determine which character(s) you would like to use to represent the EAN-8 symbology. Reference [Appendix A, ASCII Conversion Chart](#) to find the corresponding hex values for your chosen character(s). In this example we'll set a Code I.D. of "FF" to represent EAN-8. The hex value from the table corresponding to 'F' is 46. This value will be used in a step to follow.
2. Scan the START bar code
3. Scan the SET EAN-8 CODE I.D. bar code.
4. Turn to [Appendix B, Alpha-Numeric Pad](#) and scan the bar codes '4' and '6' (the value determined in an earlier step). Scan the bar codes '4' and '6' a second time to represent the second 'F' needed to identify the Code I.D.
5. Scan the SET bar code to accept the digits scanned.
6. Turn to the [Data Editing](#) chapter and scan the CODE ID POSITION: BEFORE BAR CODE DATA label.



NOTE



Features configured using the [Data Editing](#) chapter are universal and will affect all symbologies.

7. Scan the END bar code to exit Programming Mode.
8. The resulting message string for scanned EAN-8 labels would appear as follows:

Scanned bar code data: 02345673

Resulting message string output: FF02345673

EAN-8 – continued

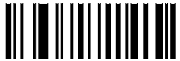
START	
STATE	BARCODE
Set EAN-8 Code I.D. Character(s)	 DEFAULT SETTING FOR THIS FEATURE: FF (4646 hex) Select 0000 to disable Code ID for this symbology only.
SET	
END	

EAN-8 — continued

EAN-8 Data Group Characters

Once you've pre-set your desired Data Group Characters¹ using the [Data Group Characters](#) feature found in [Chapter 5, Data Editing](#), you can choose to output up to two of those pre-sets whenever an EAN-8 bar code is scanned.



NOTE





The options in this section set Data Group Characters for the EAN-8 symbology ONLY. If you wish to enable this feature for additional symbologies, turn to the options in the section specific to the other symbology(s).

To set this feature:

1. Determine which Data Group pre-set(s) to output. You can select up to two from the following:
Data Group 1 * Data Group 2 * Data Group 3 * Data Group 4
For example, your choice might be Data Group 2 only; Data Groups 1 and 3; Data Groups 3 and 4; or no Data Groups.
2. Scan the START bar code to place the imager in Programming Mode.
3. Scan the SET EAN-8 DATA GROUP CHARACTERS bar code.
4. Turn to [Appendix B, Alpha-Numeric Pad](#) and scan the digits representing the Data Group designation(s) chosen in the first step above. A digit of value zero (0) selects “no group.” For example, scanning 3 and 0 would output only the character(s) set for Data Group 3 whenever an EAN-8 bar code was scanned. Scanning digits 1 and 2 would output both Data Groups 2 and 3. To select no Data Groups at all, scan 0, then 0 again.
5. Scan the SET bar code to accept the digits scanned.
6. Scan the END bar code to exit Programming Mode.

1. In that chapter, you can select which character(s) and position(s) to place Data Characters within scanned data output.

EAN-8 – continued

START	
STATE	BARCODE
Set EAN-8 Data Group(s)	 DEFAULT SETTING FOR THIS FEATURE: None (00)
SET	
END	

EAN-8 — continued

Add-ons

Add-ons (or supplemental characters) are commonly added to the end of EAN-8 bar codes. The imager will read the add-ons if they are enabled and in the field of view. Three add-on types are supported: 2-digit, 5-digit and UCC/EAN 128. Supported options are:

None — This option directs the imager to ignore add-on portion of a EAN-8 bar code but still read the main portion of the bar code.

2 Digits — The imager will read 2-digit add-ons with the EAN-8 label.

5 Digits — The imager will read 5-digit add-ons with the EAN-8 label.

2 and 5 Digits — The imager will read 2- and 5-digit add-ons with the EAN-8 label.











UCC/EAN 128 — The imager will read UCC/EAN 128 add-ons with the EAN-8 label.

2-Digit & UCC/EAN 128 — The imager will read 2-digit and UCC/EAN 128 add-ons with the EAN-8 label.

5-Digit & UCC/EAN 128 — The imager will read 5-digit and UCC/EAN 128 add-ons with the EAN-8 label.

All — The imager will read 2-digit, 5-digit and UCC/EAN 128 add-ons with the EAN-8 label.

EAN-8 — continued

START	
STATE	BARCODE
None	
2-Digits	
5-Digits	
2 & 5-Digits	
UCC/EAN 128	
2-Digit & UCC/ EAN 128	
5-Digit & UCC/ EAN 128	
All	
END	

GTIN

The following options apply to the GTIN label data format.

Disable/Enable GTIN

When this feature is enabled, the imager will translate UPC/EAN labels to the 14 digit GTIN format.

Code I.D. Selection

The Code I.D. for this symbology consists of one or two user-selectable ASCII characters. It can be appended previous to or following the transmitted GTIN bar code data depending on how this feature is enabled.

Example: Setting the GTIN Code I.D.

To configure this feature:

1. Determine which character(s) you would like to use to represent the GTIN symbology. Reference [Appendix A, ASCII Conversion Chart](#) to find the corresponding hex values for your chosen character(s). In this example we'll set a Code I.D. of "G" to represent GTIN. The value from the table corresponding to 'G' is 47. This value will be used in a step to follow.
2. Scan the START bar code
3. Scan the SET UPC-A CODE I.D. bar code.
4. Turn to [Appendix B, Alpha-Numeric Pad](#) and scan the bar codes '4' and '7' (the value 47 determined in an earlier step to represent a Code I.D. of 'G').
5. Scan the SET bar code to accept the digits scanned.
6. Turn to the [Data Editing](#) chapter and scan the CODE ID POSITION: BEFORE BAR CODE DATA label.



NOTE

Features configured using the [Data Editing](#) chapter are universal and will affect all symbologies.







7. Scan the END bar code to exit Programming Mode.

8. The resulting message string for scanned GTIN labels would appear as follows:

Scanned bar code data: 0123456789123

Resulting message string output: G0123456789123

GTIN – continued

START	
STATE	BARCODE
Disable GTIN	
Enable GTIN	
Set GTIN Code I.D. Character(s)	 DEFAULT SETTING FOR THIS FEATURE: G (47 hex) Select 0000 to disable Code ID for this symbology only.
SET	
END	

Symbologies

RSS-14

The following options apply to the RSS-14 symbology.

Disable/Enable RSS-14

When this feature is disabled, the imager will not read RSS-14 bar codes.









Checksum Transmission

Enable this option to transmit the checksum along with RSS-14 bar code data.

UCC/EAN 128 Emulation

When enabled, RSS-14 bar codes will be translated to the UCC/EAN 128 label data format.

RSS-14 — continued

START	
STATE	BARCODE
Disable RSS-14	
Enable RSS-14	
Don't Send Checksum	
Send Checksum	
Disable UCC/EAN 128 Emulation	
Enable UCC/EAN 128 Emulation	
END	

RSS-14 — continued

Truncate Leading/Ending

The leading or ending digits of bar code data characters can be truncated. Select from 00 (no truncation) to 15.



NOTE

The imager will beep instead of reading anything when the truncate value is more than the bar code data digits or the truncate leading value overlaps the truncate ending value.

START	
MODE	BARCODE
<p>Sets from 00 to 15 characters to truncate from either the leading or ending characters of scanned bar code data. To configure this feature, scan the “START” bar code above to place the unit in Programming Mode, then the SET TRUNCATION: LEADING or SET TRUNCATION: ENDING, followed by the digits from the Alpha-numeric table in Appendix B, Alpha-Numeric Pad representing the desired quantity of digits to truncate from the message string. Accept your selection by scanning the “SET” bar code below and finally, exit programming mode by scanning the “END” barcode below.</p> <p>DEFAULT SETTING FOR THIS FEATURE: 00 (None)</p>	
Set Truncation: Leading	
Set Truncation: Ending	
SET	
END	

RSS-14 — continued

Code I.D. Selection

The Code I.D. for this symbology consists of one or two user-selectable ASCII characters. It can be appended previous to or following the transmitted RSS-14 bar code data depending on how this feature is enabled.

Example: Setting the RSS-14 Code I.D.

To configure this feature:

1. Determine which character(s) you would like to use to represent the RSS-14 symbology. Reference [Appendix A, ASCII Conversion Chart](#) to find the corresponding hex values for your chosen character(s). In this example we'll set a Code I.D. of "R4" to represent RSS-14. The value from the table corresponding to "R" is 52 and the value for '4' is 34. These values will be used in a step to follow.
2. Scan the START bar code
3. Scan the SET RSS-14 CODE I.D. bar code.
4. Turn to [Appendix B, Alpha-Numeric Pad](#) and scan the bar codes '5' and '2' (the value determined in an earlier step to represent 'R'). Then scan the bar codes '3' and '4' (hex equivalent for '4').
5. Scan the SET bar code to accept the digits scanned.
6. Turn to the [Data Editing](#) chapter and scan the CODE ID POSITION: BEFORE BAR CODE DATA label.

**NOTE**

Features configured using the [Data Editing](#) chapter are universal and will affect all symbologies.





7. Scan the END bar code to exit Programming Mode.
8. The resulting message string for scanned RSS-14 labels would appear as follows:

Scanned bar code data: 0123456789123

Resulting message string output: R40123456789123

Symbologies

RSS-14 — continued

START	
STATE	BARCODE
Set RSS-14 Code I.D. Character(s)	 DEFAULT SETTING FOR THIS FEATURE: R4 (52hex, 34 hex) Select 0000 to disable Code ID for this symbology only.
SET	
END	

RSS-14 — continued

RSS-14 Data Group Characters

Once you've pre-set your desired Data Group Characters¹ using the [Data Group Characters](#) feature found in [Chapter 5, Data Editing](#), you can choose to output up to two of those pre-sets whenever an RSS-14 bar code is scanned.



NOTE

The options in this section set Data Group Characters for the RSS-14 symbology ONLY. If you wish to enable this feature for additional symbologies, turn to the options in the section specific to the other symbology(s).





To set this feature:

1. Determine which Data Group pre-set(s) to output. You can select up to two from the following:
 Data Group 1 * Data Group 2 * Data Group 3 * Data Group 4
 For example, your choice might be Data Group 2 only; Data Groups 1 and 3; Data Groups 3 and 4; or no Data Groups.
2. Scan the START bar code to place the imager in Programming Mode.
3. Scan the SET RSS-14 DATA GROUP CHARACTERS bar code.
4. Turn to [Appendix B, Alpha-Numeric Pad](#) and scan the digits representing the Data Group designation(s) chosen in the first step above. A digit of value zero (0) selects “no group.” For example, scanning 3 and 0 would output only the character(s) set for Data Group 3 whenever an RSS-14 bar code was scanned. Scanning digits 1 and 2 would output both Data Groups 2 and 3. To select no Data Groups at all, scan 0, then 0 again.
5. Scan the SET bar code to accept the digits scanned.
6. Scan the END bar code to exit Programming Mode.

1. In that chapter, you can select which character(s) and position(s) to place Data Characters within scanned data output.

Symbologies

RSS-14 — continued

START	
STATE	BARCODE
Set RSS-14 Data Group(s)	 DEFAULT SETTING FOR THIS FEATURE: None (00)
SET	
END	

RSS Expanded







The following options apply to the RSS Expanded symbology.

Disable/Enable RSS Expanded

When this feature is disabled, the imager will not read RSS Expanded bar codes.

UCC/EAN 128 Emulation

When enabled, RSS Expanded bar codes will be translated to the UCC/EAN 128 label data format.

START	
STATE	BARCODE
Disable RSS Expanded	
Enable RSS Expanded	
Disable UCC/EAN 128 Emulation	
Enable UCC/EAN 128 Emulation	
END	

Minimum/Maximum Code Length





Many symbologies have their own maximum and minimum code length, which can be set to qualify data entry. The length is defined as the actual bar code data length to be sent. Labels with lengths below the minimum or above the maximum will be rejected. If the maximum code length is set to zero, the global maximum is in effect. If the minimum code length is set to zero, the global minimum is in effect.



NOTE

Ensure that the minimum length setting is not greater than the maximum length setting; otherwise, all the labels of the symbology will be unreadable. You can set the same value for both minimum and maximum length to force decoding of only bar codes of a certain length.

RSS Expanded – continued

START	
MODE	BARCODE
Set Maximum Length	 DEFAULT SETTING FOR THIS FEATURE: 74
Set Minimum Length	 DEFAULT SETTING FOR THIS FEATURE: 1
SET	
END	

RSS Expanded – continued

Truncate Leading/Ending

The leading or ending digits of bar code data characters can be truncated. Select from 00 (no truncation) to 15.



NOTE

The imager will beep instead of reading anything when the truncate value is more than the bar code data digits or the truncate leading value overlaps the truncate ending value.

START	
MODE	BARCODE
<p>Sets from 00 to 15 characters to truncate from either the leading or ending characters of scanned bar code data. To configure this feature, scan the “START” bar code above to place the unit in Programming Mode, then the SET TRUNCATION: LEADING or SET TRUNCATION: ENDING, followed by the digits from the Alpha-numeric table in Appendix B, Alpha-Numeric Pad representing the desired quantity of digits to truncate from the message string. Accept your selection by scanning the “SET” bar code below and finally, exit programming mode by scanning the “END” barcode below.</p> <p>DEFAULT SETTING FOR THIS FEATURE: 00 (None)</p>	
Set Truncation: Leading	
Set Truncation: Ending	
SET	
END	

RSS Expanded – continued

Code I.D. Selection

The Code I.D. for this symbology consists of one or two user-selectable ASCII characters. It can be appended previous to or following the transmitted RSS Expanded bar code data depending on how this feature is enabled.

Example: Setting the RSS Expanded Code I.D.

To configure this feature:

1. Determine which character(s) you would like to use to represent the RSS Expanded symbology. Reference [Appendix A, ASCII Conversion Chart](#) to find the corresponding hex values for your chosen character(s). In this example we'll set a Code I.D. of "RX" to represent RSS Expanded. The value from the table corresponding to "R" is 52 and the value for "X" is 58. These values will be used in a step to follow.
2. Scan the START bar code
3. Scan the SET RSS Expanded CODE I.D. bar code.
4. Turn to [Appendix B, Alpha-Numeric Pad](#) and scan the bar codes '5' and '2' (the value determined in an earlier step to represent 'R'). Then scan the bar codes '5' and '8' (hex equivalent for 'X').
5. Scan the SET bar code to accept the digits scanned.
6. Turn to the [Data Editing](#) chapter and scan the CODE ID POSITION: BEFORE BAR CODE DATA label.



Features configured using the [Data Editing](#) chapter are universal and will affect all symbologies.



NOTE

7. Scan the END bar code to exit Programming Mode.
8. The resulting message string for scanned RSS Expanded labels would appear as follows:

Scanned bar code data: 0123456789123

Resulting message string output: RX0123456789123

RSS Expanded – continued

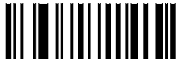
START	
STATE	BARCODE
Set RSS Expanded Code I.D. Character(s)	 DEFAULT SETTING FOR THIS FEATURE: RX (52 hex 58 hex) Select 0000 to disable Code ID for this symbology only.
SET	
END	

RSS Expanded – continued

RSS Expanded Data Group Characters

Once you've pre-set your desired Data Group Characters¹ using the [Data Group Characters](#) feature found in [Chapter 5, Data Editing](#), you can choose to output up to two of those pre-sets whenever an RSS Expanded bar code is scanned.



NOTE



The options in this section set Data Group Characters for the RSS Expanded symbology ONLY. If you wish to enable this feature for additional symbologies, turn to the options in the section specific to the other symbology(s).

To set this feature:

1. Determine which Data Group pre-set(s) to output. You can select up to two from the following:
Data Group 1 * Data Group 2 * Data Group 3 * Data Group 4
For example, your choice might be Data Group 2 only; Data Groups 1 and 3; Data Groups 3 and 4; or no Data Groups.
2. Scan the START bar code to place the imager in Programming Mode.
3. Scan the SET RSS Expanded DATA GROUP CHARACTERS bar code.
4. Turn to [Appendix B, Alpha-Numeric Pad](#) and scan the digits representing the Data Group designation(s) chosen in the first step above. A digit of value zero (0) selects “no group.” For example, scanning 3 and 0 would output only the character(s) set for Data Group 3 whenever an RSS Expanded bar code was scanned. Scanning digits 1 and 2 would output both Data Groups 2 and 3. To select no Data Groups at all, scan 0, then 0 again.
5. Scan the SET bar code to accept the digits scanned.
6. Scan the END bar code to exit Programming Mode.

1. In that chapter, you can select which character(s) and position(s) to place Data Characters within scanned data output.

RSS Expanded – continued

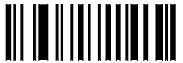
START	
STATE	BARCODE
Set RSS Expanded Data Group(s)	 DEFAULT SETTING FOR THIS FEATURE: None (00)
SET	
END	

RSS Limited

The following options apply to the RSS Limited symbology.

Disable/Enable RSS Limited

When this feature is disabled, the imager will not read RSS Limited bar codes.









Checksum Transmission

Enable this option to transmit the checksum along with RSS Limited bar code data.

UCC/EAN 128 Emulation

When enabled, RSS Limited bar codes will be translated to the UCC/EAN 128 label data format.

RSS Limited – continued

START	
STATE	BARCODE
Disable RSS Limited	
Enable Limited	
Don't Send Checksum	
Send Checksum	
Disable UCC/EAN 128 Emulation	
Enable UCC/EAN 128 Emulation	
END	

RSS Limited – continued

Truncate Leading/Ending

The leading or ending digits of bar code data characters can be truncated. Select from 00 (no truncation) to 15.



NOTE

The imager will beep instead of reading anything when the truncate value is more than the bar code data digits or the truncate leading value overlaps the truncate ending value.

START	
MODE	BARCODE
<p>Sets from 00 to 15 characters to truncate from either the leading or ending characters of scanned bar code data. To configure this feature, scan the “START” bar code above to place the unit in Programming Mode, then the SET TRUNCATION: LEADING or SET TRUNCATION: ENDING, followed by the digits from the Alpha-numeric table in Appendix B, Alpha-Numeric Pad representing the desired quantity of digits to truncate from the message string. Accept your selection by scanning the “SET” bar code below and finally, exit programming mode by scanning the “END” barcode below.</p> <p>DEFAULT SETTING FOR THIS FEATURE: 00 (None)</p>	
Set Truncation: Leading	
Set Truncation: Ending	
SET	
END	

RSS Limited – continued

Code I.D. Selection

The Code I.D. for this symbology consists of one or two user-selectable ASCII characters. It can be appended previous to or following the transmitted RSS Limited bar code data depending on how this feature is enabled.

Example: Setting the RSS Limited Code I.D.

To configure this feature:

1. Determine which character(s) you would like to use to represent the RSS Limited symbology. Reference [Appendix A, ASCII Conversion Chart](#) to find the corresponding hex values for your chosen character(s). In this example we'll set a Code I.D. of "RL" to represent RSS Limited. The value from the table corresponding to "R" is 52 and the value for "L" is 4C. These values will be used in a step to follow.
2. Scan the START bar code
3. Scan the SET RSS Limited CODE I.D. bar code.
4. Turn to [Appendix B, Alpha-Numeric Pad](#) and scan the bar codes '5' and '2' (the value determined in an earlier step to represent 'R'). Then scan the bar codes '4' and 'C' (hex equivalent for 'L').
5. Scan the SET bar code to accept the digits scanned.
6. Turn to the [Data Editing](#) chapter and scan the CODE ID POSITION: BEFORE BAR CODE DATA label.



Features configured using the [Data Editing](#) chapter are universal and will affect all symbologies.

NOTE





7. Scan the END bar code to exit Programming Mode.
8. The resulting message string for scanned RSS Limited labels would appear as follows:

Scanned bar code data: 0123456789123

Symbologies

Resulting message string output: RL0123456789123

RSS Limited – continued

START	
STATE	BARCODE
Set RSS Limited Code I.D. Character(s)	 DEFAULT SETTING FOR THIS FEATURE: RL (52hex, 4C hex) Select 0000 to disable Code ID for this symbology only.
SET	
END	

RSS Limited – continued

RSS Limited Data Group Characters

Once you've pre-set your desired Data Group Characters¹ using the [Data Group Characters](#) feature found in [Chapter 5, Data Editing](#), you can choose to output up to two of those pre-sets whenever an RSS Limited bar code is scanned.

**NOTE**

The options in this section set Data Group Characters for the RSS Limited symbology ONLY. If you wish to enable this feature for additional symbologies, turn to the options in the section specific to the other symbology(s).

To set this feature:

1. Determine which Data Group pre-set(s) to output. You can select up to two from the following:

Data Group 1 * Data Group 2 * Data Group 3 * Data Group 4





For example, your choice might be Data Group 2 only; Data Groups 1 and 3; Data Groups 3 and 4; or no Data Groups.

2. Scan the START bar code to place the imager in Programming Mode.
3. Scan the SET RSS Limited DATA GROUP CHARACTERS bar code.
4. Turn to [Appendix B, Alpha-Numeric Pad](#) and scan the digits representing the Data Group designation(s) chosen in the first step above. A digit of value zero (0) selects “no group.” For example, scanning 3 and 0 would output only the character(s) set for Data Group 3 whenever an RSS Limited bar code was scanned. Scanning digits 1 and 2 would output both Data Groups 2 and 3. To select no Data Groups at all, scan 0, then 0 again.
5. Scan the SET bar code to accept the digits scanned.
6. Scan the END bar code to exit Programming Mode.

1. In that chapter, you can select which character(s) and position(s) to place Data Characters within scanned data output.

Symbologies

RSS Limited – continued

START	
STATE	BARCODE
Set RSS Limited Data Group(s)	 DEFAULT SETTING FOR THIS FEATURE: None (00)
SET	
END	

Code 39

The following options apply to the Code 39 symbology.

Disable/Enable Code 39

When this feature is disabled, the imager will not read Code 39 bar codes.









Checksum Verification

When enabled, the imager will verify the checksum of the labels. Turn this option on only when a checksum is present in the Code 39 labels.

Checksum Transmit

Enable this option to transmit the checksum with scanned bar code data.

Code 39 – continued

START	
STATE	BARCODE
Disable Code 39	
Enable Code 39	
Disable Checksum Verification	
Enable Checksum Verification	
Disable Checksum Transmission	
Enable Checksum Transmission	
END	

Code 39 — continued





Minimum/Maximum Code Length

Many symbologies have their own maximum and minimum code length, which can be set to qualify data entry. The length is defined as the actual bar code data length to be sent. Labels with lengths below the minimum or above the maximum will be rejected. If the maximum code length is set to zero, the global maximum is in effect. If the minimum code length is set to zero, the global minimum is in effect.



NOTE

Ensure that the minimum length setting is not greater than the maximum length setting; otherwise, all the labels of the symbology will be unreadable. You can set the same value for both minimum and maximum length to force decoding of only bar codes of a certain length.

START	
MODE	BARCODE
Set Maximum Length	 DEFAULT SETTING FOR THIS FEATURE: 0
Set Minimum Length	 DEFAULT SETTING FOR THIS FEATURE:0
SET	
END	

Code 39 – continued

Truncate Leading/Ending

The leading or ending digits of bar code data characters can be truncated. Select from 00 (no truncation) to 15.



NOTE

The imager will beep instead of reading anything when the truncate value is more than the bar code data digits or the truncate leading value overlaps the truncate ending value.

START	
MODE	BARCODE
<p>Sets from 00 to 15 characters to truncate from either the leading or ending characters of scanned bar code data. To configure this feature, scan the “START” bar code above to place the unit in Programming Mode, then the SET TRUNCATION: LEADING or SET TRUNCATION: ENDING, followed by the digits from the Alpha-numeric table in Appendix B, Alpha-Numeric Pad representing the desired quantity of digits to truncate from the message string. Accept your selection by scanning the “SET” bar code below and finally, exit programming mode by scanning the “END” barcode below.</p> <p>DEFAULT SETTING FOR THIS FEATURE: 00 (None)</p>	
Set Truncation: Leading	
Set Truncation: Ending	
SET	
END	

Code 39 — continued

Code I.D. Selection

The Code I.D. for this symbology consists of one or two user-selectable ASCII characters. It can be appended previous to or following the transmitted Code 39 bar code data depending on how this feature is enabled.

Example: Setting the Code 39 Code I.D.

To configure this feature:

1. Determine which character(s) you would like to use to represent the Code 39 symbology. Reference [Appendix A, ASCII Conversion Chart](#) to find the corresponding hex values for your chosen character(s). In this example we'll set a Code I.D. of "*" (the asterisk symbol) to represent Code 39. The value from the table corresponding to "*" is 2A. This value will be used in a step to follow.
2. Scan the START bar code
3. Scan the SET Code 39 CODE I.D. bar code.
4. Turn to [Appendix B, Alpha-Numeric Pad](#) and scan the bar codes '2' and 'A' (the value determined in an earlier step to represent "*").
5. Scan the SET bar code to accept the digits scanned.
6. Turn to the [Data Editing](#) chapter and scan the CODE ID POSITION: BEFORE BAR CODE DATA label.

**NOTE**





Features configured using the [Data Editing](#) chapter are universal and will affect all symbologies.

7. Scan the END bar code to exit Programming Mode.
8. The resulting message string for scanned Code 39 labels would appear as follows:

Scanned bar code data: 0123456789123

Resulting message string output: *0123456789123

Code 39 — continued

START	
STATE	BARCODE
Set Code 39 Code I.D. Character(s)	 DEFAULT SETTING FOR THIS FEATURE: * (2A hex) Select 0000 to disable Code ID for this symbology only.
SET	
END	

Code 39 — continued

Code 39 Data Group Characters

Once you've pre-set your desired Data Group Characters¹ using the [Data Group Characters](#) feature found in [Chapter 5, Data Editing](#), you can choose to output up to two of those pre-sets whenever a Code 39 bar code is scanned.



NOTE

The options in this section set Data Group Characters for the Code 39 symbology **ONLY**. If you wish to enable this feature for additional symbologies, turn to the options in the section specific to the other symbology(s).





To set this feature:

1. Determine which Data Group pre-set(s) to output. You can select up to two from the following:
 Data Group 1 * Data Group 2 * Data Group 3 * Data Group 4
 For example, your choice might be Data Group 2 only; Data Groups 1 and 3; Data Groups 3 and 4; or no Data Groups.
2. Scan the START bar code to place the imager in Programming Mode.
3. Scan the SET Code 39 DATA GROUP CHARACTERS bar code.
4. Turn to [Appendix B, Alpha-Numeric Pad](#) and scan the digits representing the Data Group designation(s) chosen in the first step above. A digit of value zero (0) selects "no group." For example, scanning 3 and 0 would output only the character(s) set for Data Group 3 whenever a Code 39 bar code was scanned. Scanning digits 1 and 2 would output both Data Groups 2 and 3. To select no Data Groups at all, scan 0, then 0 again.
5. Scan the SET bar code to accept the digits scanned.
6. Scan the END bar code to exit Programming Mode.

1. In that chapter, you can select which character(s) and position(s) to place Data Characters within scanned data output.

Symbologies

Code 39 — continued

START	
STATE	BARCODE
Set Code 39 Data Group(s)	 DEFAULT SETTING FOR THIS FEATURE: None (00)
SET	
END	

Code 39 — continued

Format

Use this feature to select standard or Full ASCII Code 39, which is an enhanced set of Code 39 and uses a total of 128 characters to represent Full ASCII code. Each Full ASCII Code 39 character is a combination of one of the characters +, %, \$ and / with an uppercase alphabetical character (A to Z).









Append

This function allows several symbols to be concatenated and be treated as a single entry. The imager will not transmit the embedded appending code (for Code-39, a space). If the append function is enabled and other symbols are read again with the appended code, then the codes are transmitted without the code ID, preamble, or prefix. When a symbol was decoded without the appended code, the data is transmitted without the code ID and prefix, but the postamble suffix codes are appended. This function is used when the first character of Code 39 data is a space.

Start/End Transmission

The start and end characters of Code 39 are asterisks (*). You can transmit all data digits, including the two asterisks.

Code 39 — continued

START	
STATE	BARCODE
Standard Code 39	
Full ASCII Code 39	
Disable Append	
Enable Append	
Disable Start/End Transmission	
Enable Start/End Transmission	
END	

Pharmacode 39

The following options apply to the Pharmacode 39 symbology.

Disable/Enable Pharmacode 39







When this feature is disabled, the imager will not read Pharmacode 39 bar codes.

Leading 'A'

When this option is enabled, a letter A is appended to the leading end of Pharmacode 39 bar code data.

Scanned bar code data: 0123456789123

Resulting message string output: A0123456789123

START	
STATE	BARCODE
Disable Pharmacode 39	
Enable Pharmacode 39	
Disable Leading 'A'	
Enable Leading 'A'	
END	

Pharmacode 39 – continued





Minimum/Maximum Code Length

Many symbologies have their own maximum and minimum code length, which can be set to qualify data entry. The length is defined as the actual bar code data length to be sent. Labels with lengths below the minimum or above the maximum will be rejected. If the maximum code length is set to zero, the global maximum is in effect. If the minimum code length is set to zero, the global minimum is in effect.



NOTE

Ensure that the minimum length setting is not greater than the maximum length setting; otherwise, all the labels of the symbology will be unreadable. You can set the same value for both minimum and maximum length to force decoding of only bar codes of a certain length.

START	
MODE	BARCODE
Set Maximum Length	 DEFAULT SETTING FOR THIS FEATURE:12 (0C hex)
Set Minimum Length	 DEFAULT SETTING FOR THIS FEATURE:9 (09 hex)
SET	
END	

Pharmacode 39 – continued

Truncate Leading/Ending

The leading or ending digits of bar code data characters can be truncated. Select from 00 (no truncation) to 15.



NOTE

The imager will beep instead of reading anything when the truncate value is more than the bar code data digits or the truncate leading value overlaps the truncate ending value.

START	
MODE	BARCODE
<p>Sets from 00 to 15 characters to truncate from either the leading or ending characters of scanned bar code data. To configure this feature, scan the “START” bar code above to place the unit in Programming Mode, then the SET TRUNCATION: LEADING or SET TRUNCATION: ENDING, followed by the digits from the Alpha-numeric table in Appendix B, Alpha-Numeric Pad representing the desired quantity of digits to truncate from the message string. Accept your selection by scanning the “SET” bar code below and finally, exit programming mode by scanning the “END” barcode below.</p> <p>DEFAULT SETTING FOR THIS FEATURE: 00 (None)</p>	
Set Truncation: Leading	
Set Truncation: Ending	
SET	
END	

Pharmacode 39 — continued

Code I.D. Selection

The Code I.D. for this symbology consists of one or two user-selectable ASCII characters. It can be appended previous to or following the transmitted Pharmacode 39 bar code data depending on how this feature is enabled.

Example: Setting the Pharmacode 39 Code I.D.

To configure this feature:

1. Determine which character(s) you would like to use to represent the Pharmacode 39 symbology. Reference [Appendix A, ASCII Conversion Chart](#) to find the corresponding hex values for your chosen character(s). In this example we'll set a Code I.D. of "A" to represent Pharmacode 39. The value from the table corresponding to "A" is 41. This value will be used in a step to follow.
2. Scan the START bar code
3. Scan the SET PHARMACODE 39 CODE I.D. bar code.
4. Turn to [Appendix B, Alpha-Numeric Pad](#) and scan the bar codes '4' and '1' (the value determined in an earlier step to represent 'A').
5. Scan the SET bar code to accept the digits scanned.
6. Turn to the [Data Editing](#) chapter and scan the CODE ID POSITION: BEFORE BAR CODE DATA label.



NOTE





Features configured using the [Data Editing](#) chapter are universal and will affect all symbologies.

7. Scan the END bar code to exit Programming Mode.
8. The resulting message string for scanned Pharmacode 39 labels would appear as follows:

Scanned bar code data: 0123456789123

Resulting message string output: A0123456789123

Pharmacode 39 — continued

START	
STATE	BARCODE
Set Pharmacode 39 Code I.D. Character(s)	 <p>DEFAULT SETTING FOR THIS FEATURE: A (41 hex)</p> <p>Select 0000 to disable Code ID for this symbology only.</p>
SET	
END	

Pharmacode 39 – continued

Pharmacode 39 Data Group Characters

Once you've pre-set your desired Data Group Characters¹ using the [Data Group Characters](#) feature found in [Chapter 5, Data Editing](#), you can choose to output up to two of those pre-sets whenever a Pharmacode 39 bar code is scanned.



NOTE





The options in this section set Data Group Characters for the Pharmacode 39 symbology **ONLY**. If you wish to enable this feature for additional symbologies, turn to the options in the section specific to the other symbology(s).

To set this feature:

1. Determine which Data Group pre-set(s) to output. You can select up to two from the following:
Data Group 1 * Data Group 2 * Data Group 3 * Data Group 4
For example, your choice might be Data Group 2 only; Data Groups 1 and 3; Data Groups 3 and 4; or no Data Groups.
2. Scan the START bar code to place the imager in Programming Mode.
3. Scan the SET PHARMACODE 39 DATA GROUP CHARACTERS bar code.
4. Turn to [Appendix B, Alpha-Numeric Pad](#) and scan the digits representing the Data Group designation(s) chosen in the first step above. A digit of value zero (0) selects “no group.” For example, scanning 3 and 0 would output only the character(s) set for Data Group 3 whenever a Pharmacode 39 bar code was scanned. Scanning digits 1 and 2 would output both Data Groups 2 and 3. To select no Data Groups at all, scan 0, then 0 again.
5. Scan the SET bar code to accept the digits scanned.
6. Scan the END bar code to exit Programming Mode.

1. In that chapter, you can select which character(s) and position(s) to place Data Characters within scanned data output.

Pharmacode 39 – continued

START	
STATE	BARCODE
Set Pharmacode 39 Data Group(s)	 DEFAULT SETTING FOR THIS FEATURE: None (00)
SET	
END	

Code 128

The following options apply to the Code 128 symbology.

Disable/Enable Code 128

When this feature is disabled, the imager will not read Code 128 bar codes.

Checksum Verification

When enabled, the imager will verify the checksum of the labels.











Checksum Transmit

Enable this option to transmit the checksum with scanned bar code data.

Function Code Transmission

Enable this option to transmit the Code 128 function characters 1,2,3 and 4 as hexadecimal values 80,81, 82 and 83 respectively. This feature is disabled from the factory for all interfaces except Wand Emulation.

Code 128 – continued

START	
STATE	BARCODE
Disable Code 128	
Enable Code 128	
Disable Checksum Verification	
Enable Checksum Verification	
Disable Checksum Transmission	
Enable Checksum Transmission	
Disable Function Code Transmission	
Enable Function Code Transmission	
END	

Code 128 – continued





Minimum/Maximum Code Length

Many symbologies have their own maximum and minimum code length, which can be set to qualify data entry. The length is defined as the actual bar code data length to be sent. Labels with lengths below the minimum or above the maximum will be rejected. If the maximum code length is set to zero, the global maximum is in effect. If the minimum code length is set to zero, the global minimum is in effect.



NOTE

Ensure that the minimum length setting is not greater than the maximum length setting; otherwise, all the labels of the symbology will be unreadable. You can set the same value for both minimum and maximum length to force decoding of only bar codes of a certain length.

START	
MODE	BARCODE
Set Maximum Length	 DEFAULT SETTING FOR THIS FEATURE: 0
Set Minimum Length	 DEFAULT SETTING FOR THIS FEATURE:0
SET	
END	

Code 128 – continued

Truncate Leading/Ending

The leading or ending digits of bar code data characters can be truncated. Select from 00 (no truncation) to 15.



NOTE

The imager will beep instead of reading anything when the truncate value is more than the bar code data digits or the truncate leading value overlaps the truncate ending value.

START	
MODE	BARCODE
<p>Sets from 00 to 15 characters to truncate from either the leading or ending characters of scanned bar code data. To configure this feature, scan the “START” bar code above to place the unit in Programming Mode, then the SET TRUNCATION: LEADING or SET TRUNCATION: ENDING, followed by the digits from the Alpha-numeric table in Appendix B, Alpha-Numeric Pad representing the desired quantity of digits to truncate from the message string. Accept your selection by scanning the “SET” bar code below and finally, exit programming mode by scanning the “END” barcode below.</p> <p>DEFAULT SETTING FOR THIS FEATURE: 00 (None)</p>	
Set Truncation: Leading	
Set Truncation: Ending	
SET	
END	

Code 128 – continued

Code I.D. Selection

The Code I.D. for this symbology consists of one or two user-selectable ASCII characters. It can be appended previous to or following the transmitted Code 128 bar code data depending on how this feature is enabled.

Example: Setting the Code 128 Code I.D.

To configure this feature:

1. Determine which character(s) you would like to use to represent the Code 128 symbology. Reference [Appendix A, ASCII Conversion Chart](#) to find the corresponding hex values for your chosen character(s). In this example we'll set a Code I.D. of “#” (the pound sign) to represent Code 128. The value from the table corresponding to “#” is 23. This value will be used in a step to follow.
2. Scan the START bar code
3. Scan the SET CODE 128 CODE I.D. bar code.
4. Turn to [Appendix B, Alpha-Numeric Pad](#) and scan the bar codes ‘2’ and ‘3’ (the value determined in an earlier step to represent ‘#’).
5. Scan the SET bar code to accept the digits scanned.
6. Turn to the [Data Editing](#) chapter and scan the CODE ID POSITION: BEFORE BAR CODE DATA label.



NOTE





Features configured using the [Data Editing](#) chapter are universal and will affect all symbologies.

7. Scan the END bar code to exit Programming Mode.
8. The resulting message string for scanned Code 128 labels would appear as follows:

Scanned bar code data: 0123456789123

Resulting message string output: #0123456789123

Code 128 – continued

START	
STATE	BARCODE
Set Code 128 Code I.D. Character(s)	 DEFAULT SETTING FOR THIS FEATURE: # (23 hex) Select 0000 to disable Code ID for this symbology only.
SET	
END	

Code 128 – continued

Code 128 Data Group Characters

Once you've pre-set your desired Data Group Characters¹ using the [Data Group Characters](#) feature found in [Chapter 5, Data Editing](#), you can choose to output up to two of those pre-sets whenever a Code 128 bar code is scanned.



NOTE





The options in this section set Data Group Characters for the Code 128 symbology ONLY. If you wish to enable this feature for additional symbologies, turn to the options in the section specific to the other symbology(s).

To set this feature:

1. Determine which Data Group pre-set(s) to output. You can select up to two from the following:
Data Group 1 * Data Group 2 * Data Group 3 * Data Group 4
For example, your choice might be Data Group 2 only; Data Groups 1 and 3; Data Groups 3 and 4; or no Data Groups.
2. Scan the START bar code to place the imager in Programming Mode.
3. Scan the SET CODE 128 DATA GROUP CHARACTERS bar code.
4. Turn to [Appendix B, Alpha-Numeric Pad](#) and scan the digits representing the Data Group designation(s) chosen in the first step above. A digit of value zero (0) selects “no group.” For example, scanning 3 and 0 would output only the character(s) set for Data Group 3 whenever a Code 128 bar code was scanned. Scanning digits 1 and 2 would output both Data Groups 2 and 3. To select no Data Groups at all, scan 0, then 0 again.
5. Scan the SET bar code to accept the digits scanned.
6. Scan the END bar code to exit Programming Mode.

1. In that chapter, you can select which character(s) and position(s) to place Data Characters within scanned data output.

Code 128 – continued

START	
STATE	BARCODE
Set Code 128 Data Group(s)	 DEFAULT SETTING FOR THIS FEATURE: None (00)
SET	
END	







EAN-128

Format as EAN-128

When this feature is enabled, the imager will translate Code 128 data strings starting with "FNC1" character to the UCC/EAN-128 data format. The first "FNC1" character will be translated to "]C1", and any following "FNC1" characters will be translated to "<GS>(1Dhex)".





Append

When the function is enabled, the imager will store, but not immediately show data read as long as bar codes include the FNC2 code. This stored data will be displayed when a bar code is encountered which doesn't include the FNC2 code.

START	
STATE	BARCODE
Format as Standard Code 128	
Format as UCC/EAN 128	
Disable Append	
Enable Append	
END	

EAN-128 — continued**UCC/EAN-128 ID setting**

Specifies UCC/EAN-128 label ID (2 bytes) to be added to label data.

START	
MODE	BARCODE
UCC/EAN-128 ID Setting	 DEFAULT SETTING FOR THIS FEATURE: None
SET	
END	

Interleaved 2 of 5

The following options apply to the Interleaved 2 of 5 (I 2 of 5) symbology.

Disable/Enable Interleaved 2 of 5

When this feature is disabled, the imager will not read Interleaved 2 of 5 bar codes.









Checksum Verification

When enabled, the imager will verify the checksum of the labels.

Checksum Transmit

Enable this option to transmit the checksum with scanned bar code data.

Interleaved 2 of 5 – continued

START	
STATE	BARCODE
Disable Interleaved 2 of 5	
Enable Interleaved 2 of 5	
Disable Checksum Verification	
Enable Checksum Verification	
Disable Checksum Transmission	
Enable Checksum Transmission	
END	

Interleaved 2 of 5 – continued





Fixed Length Control

One or two fixed lengths may be configured for Interleaved 2 of 5. Lengths must be even and must include any check digit that may be in the bar code. If Length 1 or Length 2 are set to non-zero values, the minimum and maximum length settings are ignored. To disable fixed lengths, set Length 1 and Length 2 to a value of 00.

To configure this feature:

1. Determine the length settings needed for Fixed Length 1 and Fixed Length 2, then reference [Appendix A, ASCII Conversion Chart](#) to find the corresponding hex values for your chosen lengths. Selectable lengths are from 0x00 to 0x64 (from 0 to 100 decimal).
2. Scan the START bar code below.
3. Scan either the [Set Fixed Length 1](#) or [Set Fixed Length 2](#) bar code.
4. Turn to [Appendix B, Alpha-Numeric Pad](#) and scan the hex digits representing the desired length. For example, scan 00 to disable the feature, or 0A to set the length to 10.
5. Scan the SET bar code to accept the digits scanned.
6. Scan the END bar code to exit Programming Mode.

Interleaved 2 of 5 – continued

START	
MODE	BARCODE
DEFAULT SETTINGS FOR THIS FEATURE: 00 (None)	
Set Fixed Length 1	 <p>Scan the bar code above, then two digits from Appendix B, Alpha-Numeric Pad representing the desired length.</p>
Set Fixed Length 2	 <p>Scan the bar code above, then two digits from Appendix B, Alpha-Numeric Pad representing the desired length.</p>
SET	
END	

Interleaved 2 of 5 – continued

Minimum/Maximum Code Length

Many symbologies have their own maximum and minimum code length, which can be set to qualify data entry. The length is defined as the actual bar code data length to be sent. Labels with lengths below the minimum or above the maximum will be rejected. If the maximum code length is set to zero, the global maximum is in effect. If the minimum code length is set to zero, the global minimum is in effect.



NOTE

Ensure that the minimum length setting is not greater than the maximum length setting; otherwise, all the labels of the symbology will be unreadable. You can set the same value for both minimum and maximum length to force decoding of only bar codes of a certain length.

START	
MODE	BARCODE
Set Maximum Length	 DEFAULT SETTING FOR THIS FEATURE: 0 (00 Hex)
Set Minimum Length	 DEFAULT SETTING FOR THIS FEATURE: 6 (06 Hex)
SET	
END	

Interleaved 2 of 5 – continued

Truncate Leading/Ending

The leading or ending digits of bar code data characters can be truncated. Select from 00 (no truncation) to 15.



NOTE

The imager will beep instead of reading anything when the truncate value is more than the bar code data digits or the truncate leading value overlaps the truncate ending value.

START	
MODE	BARCODE
<p>Sets from 00 to 15 characters to truncate from either the leading or ending characters of scanned bar code data. To configure this feature, scan the "START" bar code above to place the unit in Programming Mode, then the SET TRUNCATION: LEADING or SET TRUNCATION: ENDING, followed by the digits from the Alpha-numeric table in Appendix B, Alpha-Numeric Pad representing the desired quantity of digits to truncate from the message string. Accept your selection by scanning the "SET" bar code below and finally, exit programming mode by scanning the "END" barcode below.</p> <p>DEFAULT SETTING FOR THIS FEATURE: 00 (None)</p>	
Set Truncation: Leading	
Set Truncation: Ending	
SET	
END	

Interleaved 2 of 5 – continued

Code I.D. Selection

The Code I.D. for this symbology consists of one or two user-selectable ASCII characters. It can be appended previous to or following the transmitted Interleaved 2 of 5 bar code data depending on how this feature is enabled.

Example: Setting the Interleaved 2 of 5 Code I.D.

To configure this feature:

1. Determine which character(s) you would like to use to represent the Interleaved 2 of 5 symbology. Reference [Appendix A, ASCII Conversion Chart](#) to find the corresponding hex values for your chosen character(s). In this example we'll set a Code I.D. of "i" to represent Interleaved 2 of 5. The value from the table corresponding to "i" is 69. This value will be used in a step to follow.
2. Scan the START bar code
3. Scan the SET INTERLEAVED 2 of 5 CODE I.D. bar code.
4. Turn to [Appendix B, Alpha-Numeric Pad](#) and scan the bar codes '6' and '9' (the value determined in an earlier step to represent 'i').
5. Scan the SET bar code to accept the digits scanned.
6. Turn to the [Data Editing](#) chapter and scan the CODE ID POSITION: BEFORE BAR CODE DATA label.



NOTE





Features configured using the [Data Editing](#) chapter are universal and will affect all symbologies.

7. Scan the END bar code to exit Programming Mode.
8. The resulting message string for scanned Interleaved 2 of 5 labels would appear as follows:

Scanned bar code data: 0123456789123

Resulting message string output: i0123456789123

Interleaved 2 of 5 – continued

START	
STATE	BARCODE
Set 1 2 of 5 Code I.D. Character(s)	 DEFAULT SETTING FOR THIS FEATURE: i (69 hex) Select 0000 to disable Code ID for this symbology only.
SET	
END	

Interleaved 2 of 5 – continued

Interleaved 2 of 5 Data Group Characters

Once you've pre-set your desired Data Group Characters¹ using the [Data Group Characters](#) feature found in [Chapter 5, Data Editing](#), you can choose to output up to two of those pre-sets whenever an Interleaved 2 of 5 bar code is scanned.



NOTE





The options in this section set Data Group Characters for the Interleaved 2 of 5 symbology **ONLY**. If you wish to enable this feature for additional symbologies, turn to the options in the section specific to the other symbology(s).

To set this feature:

1. Determine which Data Group pre-set(s) to output. You can select up to two from the following:
Data Group 1 * Data Group 2 * Data Group 3 * Data Group 4
For example, your choice might be Data Group 2 only; Data Groups 1 and 3; Data Groups 3 and 4; or no Data Groups.
2. Scan the START bar code to place the imager in Programming Mode.
3. Scan the SET INTERLEAVED 2 OF 5 DATA GROUP CHARACTERS bar code.
4. Turn to [Appendix B, Alpha-Numeric Pad](#) and scan the digits representing the Data Group designation(s) chosen in the first step above. A digit of value zero (0) selects “no group.” For example, scanning 3 and 0 would output only the character(s) set for Data Group 3 whenever an Interleaved 2 of 5 bar code was scanned. Scanning digits 1 and 2 would output both Data Groups 2 and 3. To select no Data Groups at all, scan 0, then 0 again.
5. Scan the SET bar code to accept the digits scanned.
6. Scan the END bar code to exit Programming Mode.

1. In that chapter, you can select which character(s) and position(s) to place Data Characters within scanned data output.

Interleaved 2 of 5 – continued

START	
STATE	BARCODE
Set Interleaved 2 of 5 Data Group(s)	 DEFAULT SETTING FOR THIS FEATURE: None (00)
SET	
END	





Symbologies

Industrial 2 of 5

The following options apply to the Industrial 2 of 5 (I 2 of 5) symbology.

Disable/Enable Industrial 2 of 5

When this feature is disabled, the imager will not read Industrial 2 of 5 bar codes.

START	
STATE	BARCODE
Disable Industrial 2 of 5	
Enable Industrial 2 of 5	
END	





Industrial 2 of 5 – continued

Minimum/Maximum Code Length

Many symbologies have their own maximum and minimum code length, which can be set to qualify data entry. The length is defined as the actual bar code data length to be sent. Labels with lengths below the minimum or above the maximum will be rejected. If the maximum code length is set to zero, the global maximum is in effect. If the minimum code length is set to zero, the global minimum is in effect.



NOTE Ensure that the minimum length setting is not greater than the maximum length setting; otherwise, all the labels of the symbology will be unreadable. You can set the same value for both minimum and maximum length to force decoding of only bar codes of a certain length.

START	
MODE	BARCODE
Set Maximum Length	 DEFAULT SETTING FOR THIS FEATURE: 0 (00 Hex)
Set Minimum Length	 DEFAULT SETTING FOR THIS FEATURE: 0 (00 Hex)
SET	
END	

Industrial 2 of 5 – continued





Truncate Leading/Ending

The leading or ending digits of bar code data characters can be truncated. Select from 00 (no truncation) to 15.



NOTE

The imager will beep instead of reading anything when the truncate value is more than the bar code data digits or the truncate leading value overlaps the truncate ending value.

START	
MODE	BARCODE
<p>Sets from 00 to 15 characters to truncate from either the leading or ending characters of scanned bar code data. To configure this feature, scan the “START” bar code above to place the unit in Programming Mode, then the SET TRUNCATION: LEADING or SET TRUNCATION: ENDING, followed by the digits from the Alpha-numeric table in Appendix B, Alpha-Numeric Pad representing the desired quantity of digits to truncate from the message string. Accept your selection by scanning the “SET” bar code below and finally, exit programming mode by scanning the “END” barcode below.</p> <p>DEFAULT SETTING FOR THIS FEATURE: 00 (None)</p>	
Set Truncation: Leading	
Set Truncation: Ending	
SET	
END	

Industrial 2 of 5 – continued

Code I.D. Selection

The Code I.D. for this symbology consists of one or two user-selectable ASCII characters. It can be appended previous to or following the transmitted Industrial 2 of 5 bar code data depending on how this feature is enabled.

Example: Setting the Industrial 2 of 5 Code I.D.

To configure this feature:

1. Determine which character(s) you would like to use to represent the Industrial 2 of 5 symbology. Reference [Appendix A, ASCII Conversion Chart](#) to find the corresponding hex values for your chosen character(s). In this example we'll set a Code I.D. of "i" to represent Industrial 2 of 5. The value from the table corresponding to "i" is 69. This value will be used in a step to follow.
2. Scan the START bar code
3. Scan the SET INDUSTRIAL 2 of 5 CODE I.D. bar code.
4. Turn to [Appendix B, Alpha-Numeric Pad](#) and scan the bar codes '6' and '9' (the value determined in an earlier step to represent 'i').
5. Scan the SET bar code to accept the digits scanned.
6. Turn to the [Data Editing](#) chapter and scan the CODE ID POSITION: BEFORE BAR CODE DATA label.

**NOTE**





Features configured using the [Data Editing](#) chapter are universal and will affect all symbologies.

7. Scan the END bar code to exit Programming Mode.
8. The resulting message string for scanned Industrial 2 of 5 labels would appear as follows:

Scanned bar code data: 0123456789123

Resulting message string output: i0123456789123

Industrial 2 of 5 – continued

START	
STATE	BARCODE
Set Code 39 Code I.D. Character(s)	 DEFAULT SETTING FOR THIS FEATURE: I (69 hex) Select 0000 to disable Code ID for this symbology only.
SET	
END	

Industrial 2 of 5 — continued

Industrial 2 of 5 Data Group Characters

Once you've pre-set your desired Data Group Characters¹ using the [Data Group Characters](#) feature found in [Chapter 5, Data Editing](#), you can choose to output up to two of those pre-sets whenever an Industrial 2 of 5 bar code is scanned.



NOTE

The options in this section set Data Group Characters for the Industrial 2 of 5 symbology ONLY. If you wish to enable this feature for additional symbologies, turn to the options in the section specific to the other symbology(s).





To set this feature:

1. Determine which Data Group pre-set(s) to output. You can select up to two from the following:
 Data Group 1 * Data Group 2 * Data Group 3 * Data Group 4
 For example, your choice might be Data Group 2 only; Data Groups 1 and 3; Data Groups 3 and 4; or no Data Groups.
2. Scan the START bar code to place the imager in Programming Mode.
3. Scan the SET INDUSTRIAL 2 OF 5 DATA GROUP CHARACTERS bar code.
4. Turn to [Appendix B, Alpha-Numeric Pad](#) and scan the digits representing the Data Group designation(s) chosen in the first step above. A digit of value zero (0) selects "no group." For example, scanning 3 and 0 would output only the character(s) set for Data Group 3 whenever an Industrial 2 of 5 bar code was scanned. Scanning digits 1 and 2 would output both Data Groups 2 and 3. To select no Data Groups at all, scan 0, then 0 again.
5. Scan the SET bar code to accept the digits scanned.
6. Scan the END bar code to exit Programming Mode.

1. In that chapter, you can select which character(s) and position(s) to place Data Characters within scanned data output.

Symbologies

Industrial 2 of 5 – continued

START	
STATE	BARCODE
Set Industrial 2 of 5 Data Group(s)	 DEFAULT SETTING FOR THIS FEATURE: None (00)
SET	
END	

Matrix 2 of 5 (Eur)

The following options apply to the Matrix 2 of 5 symbology.

Disable/Enable Matrix 2 of 5

When this feature is disabled, the imager will not read Matrix 2 of 5 bar codes.









Checksum Verification

When enabled, the imager will verify the checksum of the labels.

Checksum Transmit

Enable this option to transmit the checksum with scanned bar code data.

Matrix 2 of 5 (Eur) – continued

START	
STATE	BARCODE
Disable Matrix 2 of 5	
Enable Matrix 2 of 5	
Disable Checksum Verification	
Enable Checksum Verification	
Disable Checksum Transmission	
Enable Checksum Transmission	
END	

Matrix 2 of 5 (Eur) – continued





Minimum/Maximum Code Length

Many symbologies have their own maximum and minimum code length, which can be set to qualify data entry. The length is defined as the actual bar code data length to be sent. Labels with lengths below the minimum or above the maximum will be rejected. If the maximum code length is set to zero, the global maximum is in effect. If the minimum code length is set to zero, the global minimum is in effect.



NOTE

Ensure that the minimum length setting is not greater than the maximum length setting; otherwise, all the labels of the symbology will be unreadable. You can set the same value for both minimum and maximum length to force decoding of only bar codes of a certain length.

START	
MODE	BARCODE
Set Maximum Length	 DEFAULT SETTING FOR THIS FEATURE: 00
Set Minimum Length	 DEFAULT SETTING FOR THIS FEATURE: 00
SET	
END	

Matrix 2 of 5 (Eur) – continued





Truncate Leading/Ending

The leading or ending digits of bar code data characters can be truncated. Select from 00 (no truncation) to 15.



NOTE

The imager will beep instead of reading anything when the truncate value is more than the bar code data digits or the truncate leading value overlaps the truncate ending value.

START	
MODE	BARCODE
<p>Sets from 00 to 15 characters to truncate from either the leading or ending characters of scanned bar code data. To configure this feature, scan the “START” bar code above to place the unit in Programming Mode, then the SET TRUNCATION: LEADING or SET TRUNCATION: ENDING, followed by the digits from the Alpha-numeric table in Appendix B, Alpha-Numeric Pad representing the desired quantity of digits to truncate from the message string. Accept your selection by scanning the “SET” bar code below and finally, exit programming mode by scanning the “END” barcode below.</p> <p>DEFAULT SETTING FOR THIS FEATURE: 00 (None)</p>	
Set Truncation: Leading	
Set Truncation: Ending	
SET	
END	

Matrix 2 of 5 (Eur) – continued

Code I.D. Selection

The Code I.D. for this symbology consists of one or two user-selectable ASCII characters. It can be appended previous to or following the transmitted Matrix 2 of 5 bar code data depending on how this feature is enabled.

Example: Setting the Matrix 2 of 5 Code I.D.

To configure this feature:

1. Determine which character(s) you would like to use to represent the Matrix 2 of 5 symbology. Reference [Appendix A, ASCII Conversion Chart](#) to find the corresponding hex values for your chosen character(s). In this example we'll set a Code I.D. of "B" to represent Matrix 2 of 5. The value from the table corresponding to "B" is 42. This value will be used in a step to follow.
2. Scan the START bar code
3. Scan the SET MATRIX 2 OF 5 CODE I.D. bar code.
4. Turn to [Appendix B, Alpha-Numeric Pad](#) and scan the bar codes '4' and '2' (the value determined in an earlier step to represent 'B').
5. Scan the SET bar code to accept the digits scanned.
6. Turn to the [Data Editing](#) chapter and scan the CODE ID POSITION: BEFORE BAR CODE DATA label.

**NOTE**





Features configured using the [Data Editing](#) chapter are universal and will affect all symbologies.

7. Scan the END bar code to exit Programming Mode.
8. The resulting message string for scanned Matrix 2 of 5 labels would appear as follows:

Scanned bar code data: 0123456789123

Resulting message string output: B0123456789123

Matrix 2 of 5 (Eur) – continued

START	
STATE	BARCODE
Set Matrix 2 of 5 Code I.D. Character(s)	 <p>DEFAULT SETTING FOR THIS FEATURE: B (42 hex)</p> <p>Select 0000 to disable Code ID for this symbology only.</p>
SET	
END	

Matrix 2 of 5 (Eur) – continued

Matrix 2 of 5 Data Group Characters

Once you've pre-set your desired Data Group Characters¹ using the [Data Group Characters](#) feature found in [Chapter 5, Data Editing](#), you can choose to output up to two of those pre-sets whenever a Matrix 2 of 5 bar code is scanned.



NOTE

The options in this section set Data Group Characters for the Matrix 2 of 5 symbology **ONLY**. If you wish to enable this feature for additional symbologies, turn to the options in the section specific to the other symbology(s).





To set this feature:

1. Determine which Data Group pre-set(s) to output. You can select up to two from the following:
 Data Group 1 * Data Group 2 * Data Group 3 * Data Group 4
 For example, your choice might be Data Group 2 only; Data Groups 1 and 3; Data Groups 3 and 4; or no Data Groups.
2. Scan the START bar code to place the imager in Programming Mode.
3. Scan the SET MATRIX 2 OF 5 DATA GROUP CHARACTERS bar code.
4. Turn to [Appendix B, Alpha-Numeric Pad](#) and scan the digits representing the Data Group designation(s) chosen in the first step above. A digit of value zero (0) selects “no group.” For example, scanning 3 and 0 would output only the character(s) set for Data Group 3 whenever a Matrix 2 of 5 bar code was scanned. Scanning digits 1 and 2 would output both Data Groups 2 and 3. To select no Data Groups at all, scan 0, then 0 again.
5. Scan the SET bar code to accept the digits scanned.
6. Scan the END bar code to exit Programming Mode.

1. In that chapter, you can select which character(s) and position(s) to place Data Characters within scanned data output.

Symbologies

Matrix 2 of 5 (Eur) – continued

START	
STATE	BARCODE
Set Matrix 2 of 5 Data Group(s)	 DEFAULT SETTING FOR THIS FEATURE: None (00)
SET	
END	

Codabar

The following options apply to the Codabar symbology.

Disable/Enable Codabar

When this feature is disabled, the imager will not read Codabar bar codes.









Checksum Verification

When enabled, the imager will verify the checksum of the labels.

Checksum Transmit

Enable this option to transmit the checksum with scanned bar code data.

Codabar – continued

START	
STATE	BARCODE
Disable Codabar	
Enable Codabar	
Disable Checksum Verification	
Enable Checksum Verification	
Disable Checksum Transmission	
Enable Checksum Transmission	
END	

Codabar — continued





Minimum/Maximum Code Length

Many symbologies have their own maximum and minimum code length, which can be set to qualify data entry. The length is defined as the actual bar code data length to be sent. Labels with lengths below the minimum or above the maximum will be rejected. If the maximum code length is set to zero, the global maximum is in effect. If the minimum code length is set to zero, the global minimum is in effect.



NOTE

Ensure that the minimum length setting is not greater than the maximum length setting; otherwise, all the labels of the symbology will be unreadable. You can set the same value for both minimum and maximum length to force decoding of only bar codes of a certain length.

START	
MODE	BARCODE
Set Maximum Length	 DEFAULT SETTING FOR THIS FEATURE: 00
Set Minimum Length	 DEFAULT SETTING FOR THIS FEATURE: 08
SET	
END	

Codabar – continued





Truncate Leading/Ending

The leading or ending digits of bar code data characters can be truncated. Select from 00 (no truncation) to 15.



NOTE

The imager will beep instead of reading anything when the truncate value is more than the bar code data digits or the truncate leading value overlaps the truncate ending value.

START	
MODE	BARCODE
<p>Sets from 00 to 15 characters to truncate from either the leading or ending characters of scanned bar code data. To configure this feature, scan the “START” bar code above to place the unit in Programming Mode, then the SET TRUNCATION: LEADING or SET TRUNCATION: ENDING, followed by the digits from the Alpha-numeric table in Appendix B, Alpha-Numeric Pad representing the desired quantity of digits to truncate from the message string. Accept your selection by scanning the “SET” bar code below and finally, exit programming mode by scanning the “END” barcode below.</p> <p>DEFAULT SETTING FOR THIS FEATURE: 00 (None)</p>	
Set Truncation: Leading	
Set Truncation: Ending	
SET	
END	

Codabar — continued

Code I.D. Selection

The Code I.D. for this symbology consists of one or two user-selectable ASCII characters. It can be appended previous to or following the transmitted Codabar bar code data depending on how this feature is enabled.

Example: Setting the Codabar Code I.D.

To configure this feature:

1. Determine which character(s) you would like to use to represent the Codabar symbology. Reference [Appendix A, ASCII Conversion Chart](#) to find the corresponding hex values for your chosen character(s). In this example we'll set a Code I.D. of “%” (the percent sign) to represent Codabar. The value from the table corresponding to ‘%’ is 25. This value will be used in a step to follow.
2. Scan the START bar code
3. Scan the SET CODABAR CODE I.D. bar code.
4. Turn to [Appendix B, Alpha-Numeric Pad](#) and scan the bar codes ‘2’ and ‘5’ (the value determined in an earlier step to represent ‘%’).
5. Scan the SET bar code to accept the digits scanned.
6. Turn to the [Data Editing](#) chapter and scan the CODE ID POSITION: BEFORE BAR CODE DATA label.

**NOTE**





Features configured using the [Data Editing](#) chapter are universal and will affect all symbologies.

7. Scan the END bar code to exit Programming Mode.
8. The resulting message string for scanned Codabar labels would appear as follows:

Scanned bar code data: 0123456789123

Resulting message string output: %0123456789123

Codabar – continued

START	
STATE	BARCODE
Set Codabar Code I.D. Character(s)	 <p>DEFAULT SETTING FOR THIS FEATURE: % (25 hex)</p> <p>Select 0000 to disable Code ID for this symbology only.</p>
SET	
END	

Codabar — continued

Codabar Data Group Characters

Once you've pre-set your desired Data Group Characters¹ using the [Data Group Characters](#) feature found in [Chapter 5, Data Editing](#), you can choose to output up to two of those pre-sets whenever a Codabar bar code is scanned.

**NOTE**

The options in this section set Data Group Characters for the Codabar symbology **ONLY**. If you wish to enable this feature for additional symbologies, turn to the options in the section specific to the other symbology(s).





To set this feature:

1. Determine which Data Group pre-set(s) to output. You can select up to two from the following:
Data Group 1 * Data Group 2 * Data Group 3 * Data Group 4
For example, your choice might be Data Group 2 only; Data Groups 1 and 3; Data Groups 3 and 4; or no Data Groups.
2. Scan the START bar code to place the imager in Programming Mode.
3. Scan the SET CODABAR DATA GROUP CHARACTERS bar code.
4. Turn to [Appendix B, Alpha-Numeric Pad](#) and scan the digits representing the Data Group designation(s) chosen in the first step above. A digit of value zero (0) selects "no group." For example, scanning 3 and 0 would output only the character(s) set for Data Group 3 whenever a Codabar bar code was scanned. Scanning digits 1 and 2 would output both Data Groups 2 and 3. To select no Data Groups at all, scan 0, then 0 again.
5. Scan the SET bar code to accept the digits scanned.
6. Scan the END bar code to exit Programming Mode.

1. In that chapter, you can select which character(s) and position(s) to place Data Characters within scanned data output.

Symbologies

Codabar – continued







START	
STATE	BARCODE
Set Codabar Data Group(s)	 DEFAULT SETTING FOR THIS FEATURE: None (00)
SET	
END	

Start/End Type

Codabar has four pairs of Start/End patterns. Select one pair to match your application.

Start/End Transmission

The transmission of start and end characters of Codabar is selected below.

START	
STATE	BARCODE
Start/Stop Type: ABCD/ ABCD	
Start/Stop Type: abcd/ abcd	
Start/Stop Type: ABCD/ TN*E	
Start/Stop Type: abcd/tn*e	
Disable Start/End Transmission	
Enable Start/End Transmission	
END	

Code 93

The following options apply to the Code 93 symbology.

Disable/Enable Code 93

When this feature is disabled, the imager will not read Code 93 bar codes.









Checksum Verification

When enabled, the imager will verify the checksum of the labels.

Checksum Transmit

Enable this option to transmit the checksum with scanned bar code data.

Code 93 — continued

START	
STATE	BARCODE
Disable Code 93	
Enable Code 93	
Disable Checksum Verification	
Enable Checksum Verification	
Disable Checksum Transmission	
Enable Checksum Transmission	
END	

Code 93 – continued





Minimum/Maximum Code Length

Many symbologies have their own maximum and minimum code length, which can be set to qualify data entry. The length is defined as the actual bar code data length to be sent. Labels with lengths below the minimum or above the maximum will be rejected. If the maximum code length is set to zero, the global maximum is in effect. If the minimum code length is set to zero, the global minimum is in effect.



NOTE

Ensure that the minimum length setting is not greater than the maximum length setting; otherwise, all the labels of the symbology will be unreadable. You can set the same value for both minimum and maximum length to force decoding of only bar codes of a certain length.

START	
MODE	BARCODE
Set Maximum Length	 DEFAULT SETTING FOR THIS FEATURE: 00
Set Minimum Length	 DEFAULT SETTING FOR THIS FEATURE: 00
SET	
END	

Code 93 — continued

Truncate Leading/Ending

The leading or ending digits of bar code data characters can be truncated. Select from 00 (no truncation) to 15.



NOTE

The imager will beep instead of reading anything when the truncate value is more than the bar code data digits or the truncate leading value overlaps the truncate ending value.

START	
MODE	BARCODE
<p>Sets from 00 to 15 characters to truncate from either the leading or ending characters of scanned bar code data. To configure this feature, scan the “START” bar code above to place the unit in Programming Mode, then the SET TRUNCATION: LEADING or SET TRUNCATION: ENDING, followed by the digits from the Alpha-numeric table in Appendix B, Alpha-Numeric Pad representing the desired quantity of digits to truncate from the message string. Accept your selection by scanning the “SET” bar code below and finally, exit programming mode by scanning the “END” barcode below.</p> <p>DEFAULT SETTING FOR THIS FEATURE: 00 (None)</p>	
Set Truncation: Leading	
Set Truncation: Ending	
SET	
END	

Code 93 – continued

Code I.D. Selection

The Code I.D. for this symbology consists of one or two user-selectable ASCII characters. It can be appended previous to or following the transmitted Code 93 bar code data depending on how this feature is enabled.

Example: Setting the Code 93 Code I.D.

To configure this feature:

1. Determine which character(s) you would like to use to represent the Code 93 symbology. Reference [Appendix A, ASCII Conversion Chart](#) to find the corresponding hex values for your chosen character(s). In this example we'll set a Code I.D. of "&" to represent Code 93. The value from the table corresponding to "&" is 26. This value will be used in a step to follow.
2. Scan the START bar code
3. Scan the SET CODE 93 CODE I.D. bar code.
4. Turn to [Appendix B, Alpha-Numeric Pad](#) and scan the bar codes '2' and '6' (the value determined in an earlier step to represent '&').
5. Scan the SET bar code to accept the digits scanned.
6. Turn to the [Data Editing](#) chapter and scan the CODE ID POSITION: BEFORE BAR CODE DATA label.



NOTE





Features configured using the [Data Editing](#) chapter are universal and will affect all symbologies.

7. Scan the END bar code to exit Programming Mode.
8. The resulting message string for scanned Code 93 labels would appear as follows:

Scanned bar code data: 0123456789123

Resulting message string output: &0123456789123

Code 93 — continued

START	
STATE	BARCODE
Set Matrix 2 of 5 Code I.D. Character(s)	 DEFAULT SETTING FOR THIS FEATURE: & (26 hex) Select 0000 to disable Code ID for this symbology only.
SET	
END	

Code 93 – continued

Code 93 Data Group Characters

Once you've pre-set your desired Data Group Characters¹ using the [Data Group Characters](#) feature found in [Chapter 5, Data Editing](#), you can choose to output up to two of those pre-sets whenever a Code 93 bar code is scanned.



NOTE





The options in this section set Data Group Characters for the Code 93 symbology **ONLY**. If you wish to enable this feature for additional symbologies, turn to the options in the section specific to the other symbology(s).

To set this feature:

1. Determine which Data Group pre-set(s) to output. You can select up to two from the following:
Data Group 1 * Data Group 2 * Data Group 3 * Data Group 4
For example, your choice might be Data Group 2 only; Data Groups 1 and 3; Data Groups 3 and 4; or no Data Groups.
2. Scan the START bar code to place the imager in Programming Mode.
3. Scan the SET CODE 93 DATA GROUP CHARACTERS bar code.
4. Turn to [Appendix B, Alpha-Numeric Pad](#) and scan the digits representing the Data Group designation(s) chosen in the first step above. A digit of value zero (0) selects “no group.” For example, scanning 3 and 0 would output only the character(s) set for Data Group 3 whenever a Code 93 bar code was scanned. Scanning digits 1 and 2 would output both Data Groups 2 and 3. To select no Data Groups at all, scan 0, then 0 again.
5. Scan the SET bar code to accept the digits scanned.
6. Scan the END bar code to exit Programming Mode.

1. In that chapter, you can select which character(s) and position(s) to place Data Characters within scanned data output.

Code 93 — continued

START	
STATE	BARCODE
Set Code 93 Data Group(s)	 DEFAULT SETTING FOR THIS FEATURE: None (00)
SET	
END	

Code 11

The following options apply to the Code 11 symbology.

Disable/Enable Code 11

When this feature is disabled, the imager will not read Code 11 bar codes.

Checksum Verification

When enabled, the imager will verify the check sum of the labels.

Checksum Transmit

When this option is enabled, the imager will transmit one-digit or two-digit checksums, depending upon the setting for checksum verification.

Code 11 – continued

START	
STATE	BARCODE
Disable Code 11	
Enable Code 11	
Disable Checksum Verification	
1-Digit Checksum Verification	
2-Digit Checksum Verification	
Disable Checksum Transmission	
Enable Checksum Transmission	
END	

Code 11 – continued





Minimum/Maximum Code Length

Many symbologies have their own maximum and minimum code length, which can be set to qualify data entry. The length is defined as the actual bar code data length to be sent. Labels with lengths below the minimum or above the maximum will be rejected. If the maximum code length is set to zero, the global maximum is in effect. If the minimum code length is set to zero, the global minimum is in effect..



NOTE

Ensure that the minimum length setting is not greater than the maximum length setting; otherwise, all the labels of the symbology will be unreadable. You can set the same value for both minimum and maximum length to force decoding of only bar codes of a certain length.

START	
MODE	BARCODE
Set Maximum Length	 DEFAULT SETTING FOR THIS FEATURE: 00
Set Minimum Length	 DEFAULT SETTING FOR THIS FEATURE: 00
SET	
END	

Code 11 – continued

Truncate Leading/Ending

The leading or ending digits of bar code data characters can be truncated. Select from 00 (no truncation) to 15.



NOTE

The imager will beep instead of reading anything when the truncate value is more than the bar code data digits or the truncate leading value overlaps the truncate ending value.

START	
MODE	BARCODE
<p>Sets from 00 to 15 characters to truncate from either the leading or ending characters of scanned bar code data. To configure this feature, scan the “START” bar code above to place the unit in Programming Mode, then the SET TRUNCATION: LEADING or SET TRUNCATION: ENDING, followed by the digits from the Alpha-numeric table in Appendix B, Alpha-Numeric Pad representing the desired quantity of digits to truncate from the message string. Accept your selection by scanning the “SET” bar code below and finally, exit programming mode by scanning the “END” barcode below.</p> <p>DEFAULT SETTING FOR THIS FEATURE: 00 (None)</p>	
Set Truncation: Leading	
Set Truncation: Ending	
SET	
END	

Code 11 – continued

Code I.D. Selection

The Code I.D. for this symbology consists of one or two user-selectable ASCII characters. It can be appended previous to or following the transmitted Code 11 bar code data depending on how this feature is enabled.

Example: Setting the Code 11 Code I.D.

To configure this feature:

1. Determine which character(s) you would like to use to represent the Code 11 symbology. Reference [Appendix A, ASCII Conversion Chart](#) to find the corresponding hex values for your chosen character(s). In this example we'll set a Code I.D. of "O" to represent Code 11. The value from the table corresponding to "O" is 4F. This value will be used in a step to follow.
2. Scan the START bar code
3. Scan the SET CODE 11 CODE I.D. bar code.
4. Turn to [Appendix B, Alpha-Numeric Pad](#) and scan the bar codes '4' and 'F' (the value determined in an earlier step to represent 'O').
5. Scan the SET bar code to accept the digits scanned.
6. Turn to the [Data Editing](#) chapter and scan the CODE ID POSITION: BEFORE BAR CODE DATA label.



NOTE





Features configured using the [Data Editing](#) chapter are universal and will affect all symbologies.

7. Scan the END bar code to exit Programming Mode.
8. The resulting message string for scanned Code 11 labels would appear as follows:

Scanned bar code data: 0123456789123

Resulting message string output: O0123456789123

Code 11 — continued

START	
STATE	BARCODE
Set Matrix 2 of 5 Code I.D. Character(s)	 <p>DEFAULT SETTING FOR THIS FEATURE: 0 (4F hex)</p> <p>Select 0000 to disable Code ID for this symbology only.</p>
SET	
END	

Code 11 – continued

Code 11 Data Group Characters

Once you've pre-set your desired Data Group Characters¹ using the [Data Group Characters](#) feature found in [Chapter 5, Data Editing](#), you can choose to output up to two of those pre-sets whenever a Code 11 bar code is scanned.



NOTE



The options in this section set Data Group Characters for the Code 11 symbology ONLY. If you wish to enable this feature for additional symbologies, turn to the options in the section specific to the other symbology(s).

To set this feature:

1. Determine which Data Group pre-set(s) to output. You can select up to two from the following:
Data Group 1 * Data Group 2 * Data Group 3 * Data Group 4
For example, your choice might be Data Group 2 only; Data Groups 1 and 3; Data Groups 3 and 4; or no Data Groups.
2. Scan the START bar code to place the imager in Programming Mode.
3. Scan the SET CODE 11 DATA GROUP CHARACTERS bar code.
4. Turn to [Appendix B, Alpha-Numeric Pad](#) and scan the digits representing the Data Group designation(s) chosen in the first step above. A digit of value zero (0) selects “no group.” For example, scanning 3 and 0 would output only the character(s) set for Data Group 3 whenever a Code 11 bar code was scanned. Scanning digits 1 and 2 would output both Data Groups 2 and 3. To select no Data Groups at all, scan 0, then 0 again.
5. Scan the SET bar code to accept the digits scanned.
6. Scan the END bar code to exit Programming Mode.

1. In that chapter, you can select which character(s) and position(s) to place Data Characters within scanned data output.

Code 11 — continued

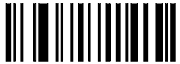
START	
STATE	BARCODE
Set Code 11 Data Group(s)	 DEFAULT SETTING FOR THIS FEATURE: None (00)
SET	
END	

MSI/Plessey

The following options apply to the MSI/Plessey symbology.

Disable/Enable MSI/Plessey

When this feature is disabled, the imager will not read MSI/Plessey bar codes.











Checksum Verification

The imager will verify Mod 10, Mod 10/10, Mod 11/10, or no check digits. Turn checksum verification on only when one or more checksums are present in the MSI Plessey labels.

Checksum Transmit

When this option is enabled, the imager will transmit one-digit or two-digit checksums, depending upon the setting for checksum verification.

MSI/Plessey – continued

START	
STATE	BARCODE
Disable MSI/Plessey	
Enable MSI/Plessey	
Disable Checksum Verification	
Mod 10 Checksum Verification	
Mod 10/10 Checksum Verification	
Mod 11/10 Checksum Verification	
Disable Checksum Transmission	
Enable Checksum Transmission	
END	

MSI/Plessey – continued





Minimum/Maximum Code Length

Many symbologies have their own maximum and minimum code length, which can be set to qualify data entry. The length is defined as the actual bar code data length to be sent. Labels with lengths below the minimum or above the maximum will be rejected. If the maximum code length is set to zero, the global maximum is in effect. If the minimum code length is set to zero, the global minimum is in effect..



NOTE

Ensure that the minimum length setting is not greater than the maximum length setting; otherwise, all the labels of the symbology will be unreadable. You can set the same value for both minimum and maximum length to force decoding of only bar codes of a certain length.

START	
MODE	BARCODE
Set Maximum Length	 DEFAULT SETTING FOR THIS FEATURE: 00
Set Minimum Length	 DEFAULT SETTING FOR THIS FEATURE: 00
SET	
END	

MSI/Plessey – continued

Truncate Leading/Ending

The leading or ending digits of bar code data characters can be truncated. Select from 00 (no truncation) to 15.



NOTE

The imager will beep instead of reading anything when the truncate value is more than the bar code data digits or the truncate leading value overlaps the truncate ending value.

START	
MODE	BARCODE
<p>Sets from 00 to 15 characters to truncate from either the leading or ending characters of scanned bar code data. To configure this feature, scan the “START” bar code above to place the unit in Programming Mode, then the SET TRUNCATION: LEADING or SET TRUNCATION: ENDING, followed by the digits from the Alpha-numeric table in Appendix B, Alpha-Numeric Pad representing the desired quantity of digits to truncate from the message string. Accept your selection by scanning the “SET” bar code below and finally, exit programming mode by scanning the “END” barcode below.</p> <p>DEFAULT SETTING FOR THIS FEATURE: 00 (None)</p>	
Set Truncation: Leading	
Set Truncation: Ending	
SET	
END	

MSI/Plessey – continued

Code I.D. Selection

The Code I.D. for this symbology consists of one or two user-selectable ASCII characters. It can be appended previous to or following the transmitted MSI/Plessey bar code data depending on how this feature is enabled.

Example: Setting the MSI/Plessey Code I.D.

To configure this feature:

1. Determine which character(s) you would like to use to represent the MSI/Plessey symbology. Reference [Appendix A, ASCII Conversion Chart](#) to find the corresponding hex values for your chosen character(s). In this example we'll set a Code I.D. of "@" to represent MSI/Plessey. The value from the table corresponding to "@" is 40. This value will be used in a step to follow.
2. Scan the START bar code
3. Scan the SET MSI/PLESSEY CODE I.D. bar code.
4. Turn to [Appendix B, Alpha-Numeric Pad](#) and scan the bar codes '4' and '0' (the value determined in an earlier step to represent '@').
5. Scan the SET bar code to accept the digits scanned.
6. Turn to the [Data Editing](#) chapter and scan the CODE ID POSITION: BEFORE BAR CODE DATA label.



NOTE





Features configured using the [Data Editing](#) chapter are universal and will affect all symbologies.

7. Scan the END bar code to exit Programming Mode.
8. The resulting message string for scanned MSI/Plessey labels would appear as follows:

Scanned bar code data: 0123456789123

Resulting message string output: @0123456789123

MSI/Plessey – continued

START	
STATE	BARCODE
Set MSI/Plessey Code I.D. Character(s)	 DEFAULT SETTING FOR THIS FEATURE: @ (40 hex) Select 0000 to disable Code ID for this symbology only.
SET	
END	

MSI/Plessey – continued

MSI/Plessey Data Group Characters

Once you've pre-set your desired Data Group Characters¹ using the [Data Group Characters](#) feature found in [Chapter 5, Data Editing](#), you can choose to output up to two of those pre-sets whenever an MSI/Plessey bar code is scanned.



NOTE





The options in this section set Data Group Characters for the MSI/Plessey symbology ONLY. If you wish to enable this feature for additional symbologies, turn to the options in the section specific to the other symbology(s).

To set this feature:

1. Determine which Data Group pre-set(s) to output. You can select up to two from the following:
Data Group 1 * Data Group 2 * Data Group 3 * Data Group 4
For example, your choice might be Data Group 2 only; Data Groups 1 and 3; Data Groups 3 and 4; or no Data Groups.
2. Scan the START bar code to place the imager in Programming Mode.
3. Scan the SET MSI/PLESSEY DATA GROUP CHARACTERS bar code.
4. Turn to [Appendix B, Alpha-Numeric Pad](#) and scan the digits representing the Data Group designation(s) chosen in the first step above. A digit of value zero (0) selects “no group.” For example, scanning 3 and 0 would output only the character(s) set for Data Group 3 whenever an MSI/Plessey bar code was scanned. Scanning digits 1 and 2 would output both Data Groups 2 and 3. To select no Data Groups at all, scan 0, then 0 again.
5. Scan the SET bar code to accept the digits scanned.
6. Scan the END bar code to exit Programming Mode.

1. In that chapter, you can select which character(s) and position(s) to place Data Characters within scanned data output.

MSI/Plessey – continued

START	
STATE	BARCODE
Set MSI/Plessey Data Group(s)	 DEFAULT SETTING FOR THIS FEATURE: None (00)
SET	
END	

Symbologies

UK-Plessey

The following options apply to the UK/Plessey symbology.

Disable/Enable UK/Plessey

When this feature is disabled, the imager will not read UK/Plessey bar codes.









Checksum Verification

When enabled, the imager will verify the check sum of the labels.

Checksum Transmit

When this option is enabled, the imager will transmit the checksum.

UK-Plessey – continued

START	
STATE	BARCODE
Disable UK/Plessey	
Enable UK/Plessey	
Disable Checksum Verification	
Enable Checksum Verification	
Disable Checksum Transmission	
Enable Checksum Transmission	
END	

UK-Plessey – continued





Minimum/Maximum Code Length

Many symbologies have their own maximum and minimum code length, which can be set to qualify data entry. The length is defined as the actual bar code data length to be sent. Labels with lengths below the minimum or above the maximum will be rejected. If the maximum code length is set to zero, the global maximum is in effect. If the minimum code length is set to zero, the global minimum is in effect..



NOTE

Ensure that the minimum length setting is not greater than the maximum length setting; otherwise, all the labels of the symbology will be unreadable. You can set the same value for both minimum and maximum length to force decoding of only bar codes of a certain length.

START	
MODE	BARCODE
Set Maximum Length	 DEFAULT SETTING FOR THIS FEATURE: 00
Set Minimum Length	 DEFAULT SETTING FOR THIS FEATURE: 00
SET	
END	

UK-Plessey – continued

Truncate Leading/Ending

The leading or ending digits of bar code data characters can be truncated. Select from 00 (no truncation) to 15.



NOTE

The imager will beep instead of reading anything when the truncate value is more than the bar code data digits or the truncate leading value overlaps the truncate ending value.

START	
MODE	BARCODE
<p>Sets from 00 to 15 characters to truncate from either the leading or ending characters of scanned bar code data. To configure this feature, scan the "START" bar code above to place the unit in Programming Mode, then the SET TRUNCATION: LEADING or SET TRUNCATION: ENDING, followed by the digits from the Alpha-numeric table in Appendix B, Alpha-Numeric Pad representing the desired quantity of digits to truncate from the message string. Accept your selection by scanning the "SET" bar code below and finally, exit programming mode by scanning the "END" barcode below.</p> <p>DEFAULT SETTING FOR THIS FEATURE: 00 (None)</p>	
Set Truncation: Leading	
Set Truncation: Ending	
SET	
END	

UK-Plessey – continued

Code I.D. Selection

The Code I.D. for this symbology consists of one or two user-selectable ASCII characters. It can be appended previous to or following the transmitted UK/Plessey bar code data depending on how this feature is enabled.

Example: Setting the UK/Plessey Code I.D.

To configure this feature:

1. Determine which character(s) you would like to use to represent the UK/Plessey symbology. Reference [Appendix A, ASCII Conversion Chart](#) to find the corresponding hex values for your chosen character(s). In this example we'll set a Code I.D. of "@" to represent UK/Plessey. The value from the table corresponding to "@" is 40. This value will be used in a step to follow.
2. Scan the START bar code
3. Scan the SET UK/PLESSEY CODE I.D. bar code.
4. Turn to [Appendix B, Alpha-Numeric Pad](#) and scan the bar codes '4' and '0' (the value determined in an earlier step to represent '@').
5. Scan the SET bar code to accept the digits scanned.
6. Turn to the [Data Editing](#) chapter and scan the CODE ID POSITION: BEFORE BAR CODE DATA label.



NOTE





Features configured using the [Data Editing](#) chapter are universal and will affect all symbologies.

7. Scan the END bar code to exit Programming Mode.
8. The resulting message string for scanned UK/Plessey labels would appear as follows:

Scanned bar code data: 0123456789123

Resulting message string output: @0123456789123

UK-Plessey — continued

START	
STATE	BARCODE
Set MSI/Plessey Code I.D. Character(s)	 DEFAULT SETTING FOR THIS FEATURE: @ (40 hex) Select 0000 to disable Code ID for this symbology only.
SET	
END	

UK-Plessey – continued

UK-Plessey Data Group Characters

Once you've pre-set your desired Data Group Characters¹ using the [Data Group Characters](#) feature found in [Chapter 5, Data Editing](#), you can choose to output up to two of those pre-sets whenever a UK-Plessey bar code is scanned.



NOTE





The options in this section set Data Group Characters for the UK-Plessey symbology ONLY. If you wish to enable this feature for additional symbologies, turn to the options in the section specific to the other symbology(s).

To set this feature:

1. Determine which Data Group pre-set(s) to output. You can select up to two from the following:
Data Group 1 * Data Group 2 * Data Group 3 * Data Group 4
For example, your choice might be Data Group 2 only; Data Groups 1 and 3; Data Groups 3 and 4; or no Data Groups.
2. Scan the START bar code to place the imager in Programming Mode.
3. Scan the SET UK-PLESSEY DATA GROUP CHARACTERS bar code.
4. Turn to [Appendix B, Alpha-Numeric Pad](#) and scan the digits representing the Data Group designation(s) chosen in the first step above. A digit of value zero (0) selects “no group.” For example, scanning 3 and 0 would output only the character(s) set for Data Group 3 whenever a UK-Plessey bar code was scanned. Scanning digits 1 and 2 would output both Data Groups 2 and 3. To select no Data Groups at all, scan 0, then 0 again.
5. Scan the SET bar code to accept the digits scanned.
6. Scan the END bar code to exit Programming Mode.

1. In that chapter, you can select which character(s) and position(s) to place Data Characters within scanned data output.

UK-Plessey — continued

START	
STATE	BARCODE
Set UK-Plessey Data Group(s)	 DEFAULT SETTING FOR THIS FEATURE: None (00)
SET	
END	

Telepen

The following options apply to the Telepen symbology.

Disable/Enable Telepen

When this feature is disabled, the imager will not read Telepen bar codes.

Checksum Verification

When enabled, the imager will verify the check sum of the labels.











Checksum Transmit

When this option is enabled, the imager will transmit the checksum.

Format

The Telepen symbology contains options for numeric only or full ASCII.

Telepen – continued

START	
STATE	BARCODE
Disable Telepen	
Enable Telepen	
Disable Checksum Verification	
Enable Checksum Verification	
Disable Checksum Transmission	
Enable Checksum Transmission	
Format = Numeric Only	
Format = Full ASCII	
END	

Telepen – continued





Minimum/Maximum Code Length

Many symbologies have their own maximum and minimum code length, which can be set to qualify data entry. The length is defined as the actual bar code data length to be sent. Labels with lengths below the minimum or above the maximum will be rejected. If the maximum code length is set to zero, the global maximum is in effect. If the minimum code length is set to zero, the global minimum is in effect..



NOTE

Ensure that the minimum length setting is not greater than the maximum length setting; otherwise, all the labels of the symbology will be unreadable. You can set the same value for both minimum and maximum length to force decoding of only bar codes of a certain length.

START	
MODE	BARCODE
Set Maximum Length	 DEFAULT SETTING FOR THIS FEATURE: 00
Set Minimum Length	 DEFAULT SETTING FOR THIS FEATURE: 00
SET	
END	

Telepen – continued





Truncate Leading/Ending

The leading or ending digits of bar code data characters can be truncated. Select from 00 (no truncation) to 15.



NOTE

The imager will beep instead of reading anything when the truncate value is more than the bar code data digits or the truncate leading value overlaps the truncate ending value.

START	
MODE	BARCODE
<p>Sets from 00 to 15 characters to truncate from either the leading or ending characters of scanned bar code data. To configure this feature, scan the “START” bar code above to place the unit in Programming Mode, then the SET TRUNCATION: LEADING or SET TRUNCATION: ENDING, followed by the digits from the Alpha-numeric table in Appendix B, Alpha-Numeric Pad representing the desired quantity of digits to truncate from the message string. Accept your selection by scanning the “SET” bar code below and finally, exit programming mode by scanning the “END” barcode below.</p> <p>DEFAULT SETTING FOR THIS FEATURE: 00 (None)</p>	
Set Truncation: Leading	
Set Truncation: Ending	
SET	
END	

Telepen — continued

Code I.D. Selection

The Code I.D. for this symbology consists of one or two user-selectable ASCII characters. It can be appended previous to or following the transmitted Telepen bar code data depending on how this feature is enabled.

Example: Setting the Telepen Code I.D.

To configure this feature:

1. Determine which character(s) you would like to use to represent the Telepen symbology. Reference [Appendix A, ASCII Conversion Chart](#) to find the corresponding hex values for your chosen character(s). In this example we'll set a Code I.D. of "S" to represent Telepen. The value from the table corresponding to "S" is 53. This value will be used in a step to follow.
2. Scan the START bar code
3. Scan the SET TELEPEN CODE I.D. bar code.
4. Turn to [Appendix B, Alpha-Numeric Pad](#) and scan the bar codes '5' and '3' (the value determined in an earlier step to represent 'S').
5. Scan the SET bar code to accept the digits scanned.
6. Turn to the [Data Editing](#) chapter and scan the CODE ID POSITION: BEFORE BAR CODE DATA label.



NOTE





Features configured using the [Data Editing](#) chapter are universal and will affect all symbologies.

7. Scan the END bar code to exit Programming Mode.
8. The resulting message string for scanned Telepen labels would appear as follows:

Scanned bar code data: 0123456789123

Resulting message string output: S0123456789123

Telepen – continued

START	
STATE	BARCODE
Set Telepen Code I.D. Character(s)	 DEFAULT SETTING FOR THIS FEATURE: S (53 hex) Select 0000 to disable Code ID for this symbology only.
SET	
END	

Telepen — continued

Telepen Data Group Characters

Once you've pre-set your desired Data Group Characters¹ using the [Data Group Characters](#) feature found in [Chapter 5, Data Editing](#), you can choose to output up to two of those pre-sets whenever a Telepen bar code is scanned.



NOTE





The options in this section set Data Group Characters for the Telepen symbology ONLY. If you wish to enable this feature for additional symbologies, turn to the options in the section specific to the other symbology(s).

To set this feature:

1. Determine which Data Group pre-set(s) to output. You can select up to two from the following:
Data Group 1 * Data Group 2 * Data Group 3 * Data Group 4
For example, your choice might be Data Group 2 only; Data Groups 1 and 3; Data Groups 3 and 4; or no Data Groups.
2. Scan the START bar code to place the imager in Programming Mode.
3. Scan the SET TELEPEN DATA GROUP CHARACTERS bar code.
4. Turn to [Appendix B, Alpha-Numeric Pad](#) and scan the digits representing the Data Group designation(s) chosen in the first step above. A digit of value zero (0) selects “no group.” For example, scanning 3 and 0 would output only the character(s) set for Data Group 3 whenever a Telepen bar code was scanned. Scanning digits 1 and 2 would output both Data Groups 2 and 3. To select no Data Groups at all, scan 0, then 0 again.
5. Scan the SET bar code to accept the digits scanned.
6. Scan the END bar code to exit Programming Mode.

1. In that chapter, you can select which character(s) and position(s) to place Data Characters within scanned data output.

Telepen – continued

START	
STATE	BARCODE
Set Telepen Data Group(s)	 DEFAULT SETTING FOR THIS FEATURE: None (00)
SET	
END	

Symbologies

Standard 2 of 5

The following options apply to the Standard 2 of 5 symbology.

Disable/Enable Standard 2 of 5

When this feature is disabled, the imager will not read Standard 2 of 5 bar codes.









Checksum Verification

When enabled, the imager will verify the checksum of the labels.

Checksum Transmit

When this option is enabled, the imager will transmit the checksum.

Standard 2 of 5 — continued

START	
STATE	BARCODE
Disable Std 2 of 5	
Enable Std 2 of 5	
Disable Checksum Verification	
Enable Checksum Verification	
Disable Checksum Transmission	
Enable Checksum Transmission	
END	

Standard 2 of 5 – continued

Minimum/Maximum Code Length

Many symbologies have their own maximum and minimum code length, which can be set to qualify data entry. The length is defined as the actual bar code data length to be sent. Labels with lengths below the minimum or above the maximum will be rejected. If the maximum code length is set to zero, the global maximum is in effect. If the minimum code length is set to zero, the global minimum is in effect.



NOTE

Ensure that the minimum length setting is not greater than the maximum length setting; otherwise, all the labels of the symbology will be unreadable. You can set the same value for both minimum and maximum length to force decoding of only bar codes of a certain length.

START	
MODE	BARCODE
Set Maximum Length	 DEFAULT SETTING FOR THIS FEATURE: 00
Set Minimum Length	 DEFAULT SETTING FOR THIS FEATURE: 00
SET	
END	

Standard 2 of 5 — continued

Truncate Leading/Ending

The leading or ending digits of bar code data characters can be truncated. Select from 00 (no truncation) to 15.



NOTE

The imager will beep instead of reading anything when the truncate value is more than the bar code data digits or the truncate leading value overlaps the truncate ending value.

START	
MODE	BARCODE
<p>Sets from 00 to 15 characters to truncate from either the leading or ending characters of scanned bar code data. To configure this feature, scan the “START” bar code above to place the unit in Programming Mode, then the SET TRUNCATION: LEADING or SET TRUNCATION: ENDING, followed by the digits from the Alpha-numeric table in Appendix B, Alpha-Numeric Pad representing the desired quantity of digits to truncate from the message string. Accept your selection by scanning the “SET” bar code below and finally, exit programming mode by scanning the “END” barcode below.</p> <p>DEFAULT SETTING FOR THIS FEATURE: 00 (None)</p>	
Set Truncation: Leading	
Set Truncation: Ending	
SET	
END	

Standard 2 of 5 — continued

Code I.D. Selection

The Code I.D. for this symbology consists of one or two user-selectable ASCII characters. It can be appended previous to or following the transmitted Standard 2 of 5 bar code data depending on how this feature is enabled.

Example: Setting the Standard 2 of 5 Code I.D.

To configure this feature:

1. Determine which character(s) you would like to use to represent the Standard 2 of 5 symbology. Reference [Appendix A, ASCII Conversion Chart](#) to find the corresponding hex values for your chosen character(s). In this example we'll set a Code I.D. of "S" to represent Standard 2 of 5. The value from the table corresponding to "S" is 53. This value will be used in a step to follow.
2. Scan the START bar code
3. Scan the SET STANDARD 2 OF 5 CODE I.D. bar code.
4. Turn to [Appendix B, Alpha-Numeric Pad](#) and scan the bar codes '5' and '3' (the value determined in an earlier step to represent 'S').
5. Scan the SET bar code to accept the digits scanned.
6. Turn to the [Data Editing](#) chapter and scan the CODE ID POSITION: BEFORE BAR CODE DATA label.



NOTE





Features configured using the [Data Editing](#) chapter are universal and will affect all symbologies.

7. Scan the END bar code to exit Programming Mode.
8. The resulting message string for scanned Standard 2 of 5 labels would appear as follows:

Scanned bar code data: 0123456789123

Resulting message string output: S0123456789123

Standard 2 of 5 — continued

START	
STATE	BARCODE
Set Std 2 of 5 Code I.D. Character(s)	 DEFAULT SETTING FOR THIS FEATURE: S (53 hex) Select 0000 to disable Code ID for this symbology only.
SET	
END	

Standard 2 of 5 — continued

Standard 2 of 5 Data Group Characters

Once you've pre-set your desired Data Group Characters¹ using the [Data Group Characters](#) feature found in [Chapter 5, Data Editing](#), you can choose to output up to two of those pre-sets whenever a Standard 2 of 5 bar code is scanned.



NOTE



The options in this section set Data Group Characters for the Standard 2 of 5 symbology **ONLY**. If you wish to enable this feature for additional symbologies, turn to the options in the section specific to the other symbology(s).

To set this feature:

1. Determine which Data Group pre-set(s) to output. You can select up to two from the following:
Data Group 1 * Data Group 2 * Data Group 3 * Data Group 4
For example, your choice might be Data Group 2 only; Data Groups 1 and 3; Data Groups 3 and 4; or no Data Groups.
2. Scan the START bar code to place the imager in Programming Mode.
3. Scan the SET STANDARD 2 OF 5 DATA GROUP CHARACTERS bar code.
4. Turn to [Appendix B, Alpha-Numeric Pad](#) and scan the digits representing the Data Group designation(s) chosen in the first step above. A digit of value zero (0) selects “no group.” For example, scanning 3 and 0 would output only the character(s) set for Data Group 3 whenever a Standard 2 of 5 bar code was scanned. Scanning digits 1 and 2 would output both Data Groups 2 and 3. To select no Data Groups at all, scan 0, then 0 again.
5. Scan the SET bar code to accept the digits scanned.
6. Scan the END bar code to exit Programming Mode.

1. In that chapter, you can select which character(s) and position(s) to place Data Characters within scanned data output.

Standard 2 of 5 — continued

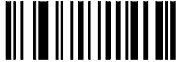
START	
STATE	BARCODE
Set Standard 2 of 5 Data Group(s)	 DEFAULT SETTING FOR THIS FEATURE: None (00)
SET	
END	





Symbologies

Code 16K

The following options apply to the Code 16K symbology.

Disable/Enable Code 16K

When this feature is disabled, the imager will not read Code 16K bar codes.

START	
STATE	BARCODE
Disable Code 16K	
Enable Code 16K	
END	

Code 16K – continued





Truncate Leading/Ending

The leading or ending digits of bar code data characters can be truncated. Select from 00 (no truncation) to 15.



NOTE

The imager will beep instead of reading anything when the truncate value is more than the bar code data digits or the truncate leading value overlaps the truncate ending value.

START	
MODE	BARCODE
<p>Sets from 00 to 15 characters to truncate from either the leading or ending characters of scanned bar code data. To configure this feature, scan the “START” bar code above to place the unit in Programming Mode, then the SET TRUNCATION: LEADING or SET TRUNCATION: ENDING, followed by the digits from the Alpha-numeric table in Appendix B, Alpha-Numeric Pad representing the desired quantity of digits to truncate from the message string. Accept your selection by scanning the “SET” bar code below and finally, exit programming mode by scanning the “END” barcode below.</p> <p>DEFAULT SETTING FOR THIS FEATURE: 00 (None)</p>	
Set Truncation: Leading	
Set Truncation: Ending	
SET	
END	

Code 16K – continued

Code I.D. Selection

The Code I.D. for this symbology consists of one or two user-selectable ASCII characters. It can be appended previous to or following the transmitted Code 16K bar code data depending on how this feature is enabled.

Example: Setting the Code 16K Code I.D.

To configure this feature:

1. Determine which character(s) you would like to use to represent the Code 16K symbology. Reference [Appendix A, ASCII Conversion Chart](#) to find the corresponding hex values for your chosen character(s). In this example we'll set a Code I.D. of "C" to represent Code 16K. The value from the table corresponding to "C" is 43. This value will be used in a step to follow.
2. Scan the START bar code
3. Scan the SET Code 16K CODE I.D. bar code.
4. Turn to [Appendix B, Alpha-Numeric Pad](#) and scan the bar codes '4' and '3' (the value determined in an earlier step to represent 'C').
5. Scan the SET bar code to accept the digits scanned.
6. Turn to the [Data Editing](#) chapter and scan the CODE ID POSITION: BEFORE BAR CODE DATA label.



NOTE





Features configured using the [Data Editing](#) chapter are universal and will affect all symbologies.

7. Scan the END bar code to exit Programming Mode.
8. The resulting message string for scanned Code 16K labels would appear as follows:

Scanned bar code data: 0123456789123

Resulting message string output: C0123456789123

Code 16K – continued

START	
STATE	BARCODE
Set Code 16K Code I.D. Character(s)	 NO DEFAULT SETTING FOR THIS FEATURE Select 0000 to disable Code ID for this symbology only.
SET	
END	

Code 16K – continued

Code 16K Data Group Characters

Once you've pre-set your desired Data Group Characters¹ using the [Data Group Characters](#) feature found in [Chapter 5, Data Editing](#), you can choose to output up to two of those pre-sets whenever a Code 16K bar code is scanned.



NOTE





The options in this section set Data Group Characters for the Code 16K symbology ONLY. If you wish to enable this feature for additional symbologies, turn to the options in the section specific to the other symbology(s).

To set this feature:

1. Determine which Data Group pre-set(s) to output. You can select up to two from the following:
Data Group 1 * Data Group 2 * Data Group 3 * Data Group 4
For example, your choice might be Data Group 2 only; Data Groups 1 and 3; Data Groups 3 and 4; or no Data Groups.
2. Scan the START bar code to place the imager in Programming Mode.
3. Scan the SET CODE 16KDATA GROUP CHARACTERS bar code.
4. Turn to [Appendix B, Alpha-Numeric Pad](#) and scan the digits representing the Data Group designation(s) chosen in the first step above. A digit of value zero (0) selects “no group.” For example, scanning 3 and 0 would output only the character(s) set for Data Group 3 whenever a Code 16K bar code was scanned. Scanning digits 1 and 2 would output both Data Groups 2 and 3. To select no Data Groups at all, scan 0, then 0 again.
5. Scan the SET bar code to accept the digits scanned.
6. Scan the END bar code to exit Programming Mode.

1. In that chapter, you can select which character(s) and position(s) to place Data Characters within scanned data output.

Code 16K – continued

START	
STATE	BARCODE
Set Code 16K Data Group(s)	 DEFAULT SETTING FOR THIS FEATURE: None (00)
SET	
END	





Symbologies

China Post

The following options apply to the China Post symbology.

Disable/Enable China Post

When this feature is disabled, the imager will not read China Post bar codes.

START	
STATE	BARCODE
Disable China Post	
Enable China Post	
END	

China Post – continued





Minimum/Maximum Code Length

Many symbologies have their own maximum and minimum code length, which can be set to qualify data entry. The length is defined as the actual bar code data length to be sent. Labels with lengths below the minimum or above the maximum will be rejected. If the maximum code length is set to zero, the global maximum is in effect. If the minimum code length is set to zero, the global minimum is in effect.



NOTE

Ensure that the minimum length setting is not greater than the maximum length setting; otherwise, all the labels of the symbology will be unreadable. You can set the same value for both minimum and maximum length to force decoding of only bar codes of a certain length.

START	
MODE	BARCODE
Set Maximum Length	 DEFAULT SETTING FOR THIS FEATURE: 11 (0BHex)
Set Minimum Length	 DEFAULT SETTING FOR THIS FEATURE: 11 (0BHex)
SET	
END	





China Post – continued

Truncate Leading/Ending

The leading or ending digits of bar code data characters can be truncated. Select from 00 (no truncation) to 15.

NOTE

The imager will beep instead of reading anything when the truncate value is more than the bar code data digits or the truncate leading value overlaps the truncate ending value.

START	
MODE	BARCODE
<p>Sets from 00 to 15 characters to truncate from either the leading or ending characters of scanned bar code data. To configure this feature, scan the “START” bar code above to place the unit in Programming Mode, then the SET TRUNCATION: LEADING or SET TRUNCATION: ENDING, followed by the digits from the Alpha-numeric table in Appendix B, Alpha-Numeric Pad representing the desired quantity of digits to truncate from the message string. Accept your selection by scanning the “SET” bar code below and finally, exit programming mode by scanning the “END” barcode below.</p> <p>DEFAULT SETTING FOR THIS FEATURE: 00 (None)</p>	
Set Truncation: Leading	
Set Truncation: Ending	
SET	
END	

China Post – continued

Code I.D. Selection

The Code I.D. for this symbology consists of one or two user-selectable ASCII characters. It can be appended previous to or following the transmitted China Post bar code data depending on how this feature is enabled.

Example: Setting the China Post Code I.D.

To configure this feature:

1. Determine which character(s) you would like to use to represent the China Post symbology. Reference [Appendix A, ASCII Conversion Chart](#) to find the corresponding hex values for your chosen character(s). In this example we'll set a Code I.D. of "t" to represent China Post. The value from the table corresponding to "t" is 74. This value will be used in a step to follow.
2. Scan the START bar code
3. Scan the SET CHINA POST CODE I.D. bar code.
4. Turn to [Appendix B, Alpha-Numeric Pad](#) and scan the bar codes '7' and '4' (the value determined in an earlier step to represent 't').
5. Scan the SET bar code to accept the digits scanned.
6. Turn to the [Data Editing](#) chapter and scan the CODE ID POSITION: BEFORE BAR CODE DATA label.

**NOTE**





Features configured using the [Data Editing](#) chapter are universal and will affect all symbologies.

7. Scan the END bar code to exit Programming Mode.
8. The resulting message string for scanned China Post labels would appear as follows:

Scanned bar code data: 0123456789123

Resulting message string output: t0123456789123

China Post – continued

START	
STATE	BARCODE
Set China Post Code I.D. Character(s)	 DEFAULT SETTING FOR THIS FEATURE: NONE Select 0000 to disable Code ID for this symbology only.
SET	
END	

China Post – continued

China Post Data Group Characters

Once you've pre-set your desired Data Group Characters¹ using the [Data Group Characters](#) feature found in [Chapter 5, Data Editing](#), you can choose to output up to two of those pre-sets whenever a China Post bar code is scanned.

**NOTE**

The options in this section set Data Group Characters for the China Post symbology ONLY. If you wish to enable this feature for additional symbologies, turn to the options in the section specific to the other symbology(s).

To set this feature:

1. Determine which Data Group pre-set(s) to output. You can select up to two from the following:

Data Group 1 * Data Group 2 * Data Group 3 * Data Group 4





For example, your choice might be Data Group 2 only; Data Groups 1 and 3; Data Groups 3 and 4; or no Data Groups.

2. Scan the START bar code to place the imager in Programming Mode.
3. Scan the SET CHINA POSTDATA GROUP CHARACTERS bar code.
4. Turn to [Appendix B, Alpha-Numeric Pad](#) and scan the digits representing the Data Group designation(s) chosen in the first step above. A digit of value zero (0) selects “no group.” For example, scanning 3 and 0 would output only the character(s) set for Data Group 3 whenever a China Post bar code was scanned. Scanning digits 1 and 2 would output both Data Groups 2 and 3. To select no Data Groups at all, scan 0, then 0 again.
5. Scan the SET bar code to accept the digits scanned.
6. Scan the END bar code to exit Programming Mode.

1. In that chapter, you can select which character(s) and position(s) to place Data Characters within scanned data output.

Symbologies

China Post – continued

START	
STATE	BARCODE
Set China Post Data Group(s)	 DEFAULT SETTING FOR THIS FEATURE: None (00)
SET	
END	

PDF 417







The following options apply to the PDF 417 symbology.

Disable/Enable PDF 417

When this feature is disabled, the imager will not read PDF 417 bar codes.

Escape Sequence Transmit

Disables/enables transmission of the escape sequence.

START	
STATE	BARCODE
Disable PDF417	
Enable PDF 417	
Disable Escape Sequence Transmit	
Enable Escape Sequence Transmit	
END	

PDF 417 – continued

Truncate Leading/Ending

The leading or ending digits of bar code data characters can be truncated. Select from 00 (no truncation) to 15.



NOTE

The imager will beep instead of reading anything when the truncate value is more than the bar code data digits or the truncate leading value overlaps the truncate ending value.

START	
MODE	BARCODE
<p>Sets from 00 to 15 characters to truncate from either the leading or ending characters of scanned bar code data. To configure this feature, scan the “START” bar code above to place the unit in Programming Mode, then the SET TRUNCATION: LEADING or SET TRUNCATION: ENDING, followed by the digits from the Alpha-numeric table in Appendix B, Alpha-Numeric Pad representing the desired quantity of digits to truncate from the message string. Accept your selection by scanning the “SET” bar code below and finally, exit programming mode by scanning the “END” barcode below.</p> <p>DEFAULT SETTING FOR THIS FEATURE: 00 (None)</p>	
Set Truncation: Leading	
Set Truncation: Ending	
SET	
END	

PDF 417 – continued

Code I.D. Selection

The Code I.D. for this symbology consists of one or two user-selectable ASCII characters. It can be appended previous to or following the transmitted PDF 417 bar code data depending on how this feature is enabled.

Example: Setting the PDF 417 Code I.D.

To configure this feature:

1. Determine which character(s) you would like to use to represent the PDF 417 symbology. Reference [Appendix A, ASCII Conversion Chart](#) to find the corresponding hex values for your chosen character(s). In this example we'll set a Code I.D. of "P" to represent PDF 417. The value from the table corresponding to "P" is 50. This value will be used in a step to follow.
2. Scan the START bar code
3. Scan the SET Code PDF 417 I.D. bar code.
4. Turn to [Appendix B, Alpha-Numeric Pad](#) and scan the bar codes '5' and '0' (the value determined in an earlier step to represent 'P').
5. Scan the SET bar code to accept the digits scanned.
6. Turn to the [Data Editing](#) chapter and scan the CODE ID POSITION: BEFORE BAR CODE DATA label.

**NOTE**





Features configured using the [Data Editing](#) chapter are universal and will affect all symbologies.

7. Scan the END bar code to exit Programming Mode.
8. The resulting message string for scanned PDF 417 labels would appear as follows:

Scanned bar code data: 0123456789123

Resulting message string output: P0123456789123

PDF 417 – continued

START	
STATE	BARCODE
Set PDF 417 Code I.D. Character(s)	 <p>DEFAULT SETTING FOR THIS FEATURE: S (53 hex)</p> <p>Select 0000 to disable Code ID for this symbology only.</p>
SET	
END	

PDF 417 – continued

PDF 417 Data Group Characters

Once you've pre-set your desired Data Group Characters¹ using the [Data Group Characters](#) feature found in [Chapter 5, Data Editing](#), you can choose to output up to two of those pre-sets whenever a PDF 417 bar code is scanned.

**NOTE**

The options in this section set Data Group Characters for the PDF 417 symbology ONLY. If you wish to enable this feature for additional symbologies, turn to the options in the section specific to the other symbology(s).

To set this feature:

1. Determine which Data Group pre-set(s) to output. You can select up to two from the following:

Data Group 1 * Data Group 2 * Data Group 3 * Data Group 4





For example, your choice might be Data Group 2 only; Data Groups 1 and 3; Data Groups 3 and 4; or no Data Groups.

2. Scan the START bar code to place the imager in Programming Mode.
3. Scan the SET PDF 417DATA GROUP CHARACTERS bar code.
4. Turn to [Appendix B, Alpha-Numeric Pad](#) and scan the digits representing the Data Group designation(s) chosen in the first step above. A digit of value zero (0) selects "no group." For example, scanning 3 and 0 would output only the character(s) set for Data Group 3 whenever a PDF 417 bar code was scanned. Scanning digits 1 and 2 would output both Data Groups 2 and 3. To select no Data Groups at all, scan 0, then 0 again.
5. Scan the SET bar code to accept the digits scanned.
6. Scan the END bar code to exit Programming Mode.

1. In that chapter, you can select which character(s) and position(s) to place Data Characters within scanned data output.

Symbologies

PDF 417 – continued

START	
STATE	BARCODE
Set PDF 417 Data Group(s)	 DEFAULT SETTING FOR THIS FEATURE: None (00)
SET	
END	

Micro PDF 417







The following options apply to the Micro PDF 417 symbology.

Disable/Enable Micro PDF 417

When this feature is disabled, the imager will not read Micro PDF 417 bar codes.

Escape Sequence Transmit

Specifies transmission format of the escape sequence.

START	
STATE	BARCODE
Disable Micro PDF417	
Enable Micro PDF 417	
Disable Escape Sequence Transmit	
GLI Escape Sequence Protocol	
ECI Escape Sequence Protocol	
END	

Micro PDF 417 – continued

Truncate Leading/Ending

The leading or ending digits of bar code data characters can be truncated. Select from 00 (no truncation) to 15.



NOTE

The imager will beep instead of reading anything when the truncate value is more than the bar code data digits or the truncate leading value overlaps the truncate ending value.

START	
MODE	BARCODE
<p>Sets from 00 to 15 characters to truncate from either the leading or ending characters of scanned bar code data. To configure this feature, scan the “START” bar code above to place the unit in Programming Mode, then the SET TRUNCATION: LEADING or SET TRUNCATION: ENDING, followed by the digits from the Alpha-numeric table in Appendix B, Alpha-Numeric Pad representing the desired quantity of digits to truncate from the message string. Accept your selection by scanning the “SET” bar code below and finally, exit programming mode by scanning the “END” barcode below.</p> <p>DEFAULT SETTING FOR THIS FEATURE: 00 (None)</p>	
Set Truncation: Leading	
Set Truncation: Ending	
SET	
END	

Micro PDF 417 – continued

Code I.D. Selection

The Code I.D. for this symbology consists of one or two user-selectable ASCII characters. It can be appended previous to or following the transmitted Micro PDF 417 bar code data depending on how this feature is enabled.

Example: Setting the Micro PDF 417 Code I.D.

To configure this feature:

1. Determine which character(s) you would like to use to represent the Micro PDF 417 symbology. Reference [Appendix A, ASCII Conversion Chart](#) to find the corresponding hex values for your chosen character(s). In this example we'll set a Code I.D. of "U" to represent Micro PDF 417. The value from the table corresponding to "U" is 55. This value will be used in a step to follow.
2. Scan the START bar code
3. Scan the SET MICRO PDF 417 I.D. bar code.
4. Turn to [Appendix B, Alpha-Numeric Pad](#) and scan the bar codes '5' and '5' (the value determined in an earlier step to represent 'U').
5. Scan the SET bar code to accept the digits scanned.
6. Turn to the [Data Editing](#) chapter and scan the CODE ID POSITION: BEFORE BAR CODE DATA label.

**NOTE**

Features configured using the [Data Editing](#) chapter are universal and will affect all symbologies.





7. Scan the END bar code to exit Programming Mode.
8. The resulting message string for scanned Micro PDF 417 labels would appear as follows:

Scanned bar code data: 0123456789123

Resulting message string output: U0123456789123

Symbologies

Micro PDF 417 – continued

START	
STATE	BARCODE
Set Micro PDF 417 Code I.D. Character(s)	 DEFAULT SETTING FOR THIS FEATURE: U (55 hex) Select 0000 to disable Code ID for this symbology only.
SET	
END	

Micro PDF 417 – continued

Micro PDF 417 Data Group Characters

Once you've pre-set your desired Data Group Characters¹ using the [Data Group Characters](#) feature found in [Chapter 5, Data Editing](#), you can choose to output up to two of those pre-sets whenever a Micro PDF 417 bar code is scanned.



NOTE

The options in this section set Data Group Characters for the Micro PDF 417 symbology **ONLY**. If you wish to enable this feature for additional symbologies, turn to the options in the section specific to the other symbology(s).





To set this feature:

1. Determine which Data Group pre-set(s) to output. You can select up to two from the following:
 Data Group 1 * Data Group 2 * Data Group 3 * Data Group 4
 For example, your choice might be Data Group 2 only; Data Groups 1 and 3; Data Groups 3 and 4; or no Data Groups.
2. Scan the START bar code to place the imager in Programming Mode.
3. Scan the SET MICRO PDF 417 DATA GROUP CHARACTERS bar code.
4. Turn to [Appendix B, Alpha-Numeric Pad](#) and scan the digits representing the Data Group designation(s) chosen in the first step above. A digit of value zero (0) selects "no group." For example, scanning 3 and 0 would output only the character(s) set for Data Group 3 whenever a Micro PDF 417 bar code was scanned. Scanning digits 1 and 2 would output both Data Groups 2 and 3. To select no Data Groups at all, scan 0, then 0 again.
5. Scan the SET bar code to accept the digits scanned.
6. Scan the END bar code to exit Programming Mode.

1. In that chapter, you can select which character(s) and position(s) to place Data Characters within scanned data output.

Symbologies

Micro PDF 417 – continued

START	
STATE	BARCODE
Set Micro PDF 417 Data Group(s)	 DEFAULT SETTING FOR THIS FEATURE: None (00)
SET	
END	

EAN UCC Composite







The following options apply to the EAN UCC Composite symbology.

Disable/Enable EAN UCC Composite

When this feature is disabled, the imager will not read EAN UCC Composite bar codes.

UCC/EAN 128 Emulation

When enabled, EAN UCC Composite bar codes will be translated to the UCC/EAN 128 label data format.

START	
STATE	BARCODE
Disable EAN UCC Composite	
Enable EAN UCC Composite	
Disable UCC/EAN 128 Emulation	
Enable UCC/EAN 128 Emulation	
END	

EAN UCC Composite – continued

Truncate Leading/Ending

The leading or ending digits of bar code data characters can be truncated. Select from 00 (no truncation) to 15.

NOTE

The imager will beep instead of reading anything when the truncate value is more than the bar code data digits or the truncate leading value overlaps the truncate ending value.

START	
MODE	BARCODE
<p>Sets from 00 to 15 characters to truncate from either the leading or ending characters of scanned bar code data. To configure this feature, scan the “START” bar code above to place the unit in Programming Mode, then the SET TRUNCATION: LEADING or SET TRUNCATION: ENDING, followed by the digits from the Alpha-numeric table in Appendix B, Alpha-Numeric Pad representing the desired quantity of digits to truncate from the message string. Accept your selection by scanning the “SET” bar code below and finally, exit programming mode by scanning the “END” barcode below.</p> <p>DEFAULT SETTING FOR THIS FEATURE: 00 (None)</p>	
Set Truncation: Leading	
Set Truncation: Ending	
SET	
END	

EAN UCC Composite — continued

Code I.D. Selection

The Code I.D. for this symbology consists of one or two user-selectable ASCII characters. It can be appended previous to or following the transmitted EAN UCC Composite bar code data depending on how this feature is enabled.

Example: Setting the EAN UCC Composite Code I.D.

To configure this feature:

1. Determine which character(s) you would like to use to represent the EAN UCC Composite symbology. Reference [Appendix A, ASCII Conversion Chart](#) to find the corresponding hex values for your chosen character(s). In this example we'll set a Code I.D. of "RC" to represent EAN UCC Composite. The value from the table corresponding to "R" is 52, for 'C', 43. These value will be used in a step to follow.
2. Scan the START bar code
3. Scan the SET EAN UCC COMPOSITE I.D. bar code.
4. Turn to [Appendix B, Alpha-Numeric Pad](#) and scan the bar codes '5' and '2' (the value determined in an earlier step to represent 'R'), then the bar codes '4' and '3' to represent the letter 'C'.
5. Scan the SET bar code to accept the digits scanned.
6. Turn to the [Data Editing](#) chapter and scan the CODE ID POSITION: BEFORE BAR CODE DATA label.



Features configured using the [Data Editing](#) chapter are universal and will affect all symbologies.

NOTE





7. Scan the END bar code to exit Programming Mode.
8. The resulting message string for scanned EAN UCC Composite labels would appear as follows:

Scanned bar code data: 0123456789123

Resulting message string output: RC0123456789123

Symbologies

EAN UCC Composite — continued

START	
STATE	BARCODE
Set EAN UCC Composite Code I.D. Character(s)	 DEFAULT SETTING FOR THIS FEATURE: RC (5243 hex) Select 0000 to disable Code ID for this symbology only.
SET	
END	

EAN UCC Composite — continued

EAN UCC Composite Data Group Characters

Once you've pre-set your desired Data Group Characters¹ using the [Data Group Characters](#) feature found in [Chapter 5, Data Editing](#), you can choose to output up to two of those pre-sets whenever an EAN UCC Composite bar code is scanned.

**NOTE**

The options in this section set Data Group Characters for the EAN UCC Composite symbology ONLY. If you wish to enable this feature for additional symbologies, turn to the options in the section specific to the other symbology(s).





To set this feature:

1. Determine which Data Group pre-set(s) to output. You can select up to two from the following:
Data Group 1 * Data Group 2 * Data Group 3 * Data Group 4
For example, your choice might be Data Group 2 only; Data Groups 1 and 3; Data Groups 3 and 4; or no Data Groups.
2. Scan the START bar code to place the imager in Programming Mode.
3. Scan the SET EAN UCC COMPOSITEDATA GROUP CHARACTERS bar code.
4. Turn to [Appendix B, Alpha-Numeric Pad](#) and scan the digits representing the Data Group designation(s) chosen in the first step above. A digit of value zero (0) selects "no group." For example, scanning 3 and 0 would output only the character(s) set for Data Group 3 whenever an EAN UCC Composite bar code was scanned. Scanning digits 1 and 2 would output both Data Groups 2 and 3. To select no Data Groups at all, scan 0, then 0 again.
5. Scan the SET bar code to accept the digits scanned.
6. Scan the END bar code to exit Programming Mode.

1. In that chapter, you can select which character(s) and position(s) to place Data Characters within scanned data output.

Symbologies

EAN UCC Composite – continued

START	
STATE	BARCODE
Set EAN UCC Composite Data Group(s)	 DEFAULT SETTING FOR THIS FEATURE: None (00)
SET	
END	

Code 4/5







The following options apply to the Code 4 and Code 5 symbologies.

Disable/Enable Code 4 and Code 5

When this feature is disabled, the imager will not read Code 4 or Code 5 bar codes.

Data Transmission Format

Hex or decimal data transmission format may be selected.

START	
STATE	BARCODE
Disable Code 4/5	
Enable Code 4/5	
Hex Transmission Format	
Decimal Transmission Format	
END	

Code I.D. Selection

The Code I.D. for this symbology consists of one or two user-selectable ASCII characters. It can be appended previous to or following the transmitted Code 4/5 bar code data depending on how this feature is enabled.

Example: Setting the Code 4/5 Code I.D.

To configure this feature:

1. Determine which character(s) you would like to use to represent the Code 4/5 symbology. Reference [Appendix A, ASCII Conversion Chart](#) to find the corresponding hex values for your chosen character(s). In this example we'll set a Code I.D. of "N" to represent Code 4/5. The value from the table corresponding to "N" is 4E, . This value will be used in a step to follow.
2. Scan the START bar code
3. Scan the SET Code 4/5 I.D. bar code.
4. Turn to [Appendix B, Alpha-Numeric Pad](#) and scan the bar codes '4' and 'E' (the value determined in an earlier step to represent 'N'),
5. Scan the SET bar code to accept the digits scanned.
6. Turn to the [Data Editing](#) chapter and scan the CODE ID POSITION: BEFORE BAR CODE DATA label.



NOTE





Features configured using the [Data Editing](#) chapter are universal and will affect all symbologies.

7. Scan the END bar code to exit Programming Mode.
8. The resulting message string for scanned Code 4/5 labels would appear as follows:

Scanned bar code data:0123456789123

Resulting message string output:N0123456789123

Code 4/5 – continued

START	
STATE	BARCODE
Set Code 4/5 Code I.D. Character(s)	 <p>DEFAULT SETTING FOR THIS FEATURE: N (4E hex)</p> <p>Select 0000 to disable Code ID for this symbology only.</p>
SET	
END	

Code 4/5 – continued

Code 4/5 Data Group Characters

Once you've pre-set your desired Data Group Characters¹ using the [Data Group Characters](#) feature found in [Chapter 5, Data Editing](#), you can choose to output up to two of those pre-sets whenever a Code 4 or Code 5 bar code is scanned.



NOTE





The options in this section set Data Group Characters for Code 4/Code symbologies **ONLY**. If you wish to enable this feature for additional symbologies, turn to the options in the section specific to the other symbology(s).

To set this feature:

1. Determine which Data Group pre-set(s) to output. You can select up to two from the following:
Data Group 1 * Data Group 2 * Data Group 3 * Data Group 4
For example, your choice might be Data Group 2 only; Data Groups 1 and 3; Data Groups 3 and 4; or no Data Groups.
2. Scan the START bar code to place the imager in Programming Mode.
3. Scan the SET CODE 4/5DATA GROUP CHARACTERS bar code.
4. Turn to [Appendix B, Alpha-Numeric Pad](#) and scan the digits representing the Data Group designation(s) chosen in the first step above. A digit of value zero (0) selects “no group.” For example, scanning 3 and 0 would output only the character(s) set for Data Group 3 whenever Code 4 or Code 5 bar code was scanned. Scanning digits 1 and 2 would output both Data Groups 2 and 3. To select no Data Groups at all, scan 0, then 0 again.
5. Scan the SET bar code to accept the digits scanned.
6. Scan the END bar code to exit Programming Mode.

1. In that chapter, you can select which character(s) and position(s) to place Data Characters within scanned data output.

Code 4/5 – continued

START	
STATE	BARCODE
Set Code 4/5 Data Group(s)	 DEFAULT SETTING FOR THIS FEATURE: None (00)
SET	
END	

NOTES

Chapter 7

Bluetooth Features

Features in this section are applicable only to Bluetooth (BT) models.

The Bluetooth model includes an imager and Base Station. When the imager and Base Station are linked together, the imager will read and decode bar codes and transmit them via a Bluetooth radio to the Base Station. The Base Station will then transmit the bar code data to the POS host system over the host cable. The host interfaces available from the Base Station are the same set as the corded version of the product.

Auto Update







When this feature is enabled, an imager and its linked Base Station can automatically ensure they stay in sync with regard to application hardware and/or configuration. This is accomplished by the linked imager and Base Station comparing application version number and configuration file check sum. If either is different, the Base Station will automatically update the imager with its application/configuration.

If the units are linked, any changes made to the Base Station configuration through the scan utility software will automatically be sent to the imager at the completion of the programming session. By the same token, any changes made to the linked imager's configuration will be transmitted to the Base Station at the end of the programming session.

The following options are available for Auto Update:













- Auto update enable — Allows both application and configuration updating.
- Configure auto update enable — Allows only configuration updating.
- Application auto update enable — Allows only application updating.
- Auto update disable — No automatic updates will be performed.

Auto Update – continued

START	
STATE	BARCODE
Auto Update Enable	
Configure Auto Update Enable	
Application Auto Update Enable	
Auto Update Disable	
END	

Deep Sleep Mode

The BT model of the imager can be placed into Deep Sleep Mode after this programmed duration (since the unit's last scanning activity). Press its trigger to wake the imager from this mode.











START	
DURATION	BARCODE
Disable	
20 Minutes	
30 Minutes	
40 Minutes	
50 Minutes	
1 Hour	
70 Minutes	
80 Minutes	
90 Minutes	
100 Minutes	
END	















Bluetooth Features

Leash Alarm

When enabled, the Leash Alarm will force the imager to sound an alarm for a preprogrammed length of time to notify if an imager is leaving the immediate vicinity of the Base Station. This is especially useful in instances where the imager might inadvertently have been placed in a bag or cart.

For this mode to be effective, [Deep Sleep Mode](#) must be disabled. If the imager is asleep, there is no way for it to know where it is relative to the Base Station because communication is not active between the devices.

START	
DURATION	BARCODE
Disable Alarm	
1 Second	
2 Seconds	
3 Seconds	
4 Seconds	
5 Seconds	
6 Seconds	
7 Seconds	
8 Seconds	

START	
DURATION	BARCODE
9 Seconds	
10 Seconds	
15 Seconds	
20 Seconds	
25 Seconds	
30 Seconds	
35 Seconds	
40 Seconds	
45 Seconds	
50 Seconds	
55 Seconds	
60 Seconds	
END	

Bluetooth Connectivity Mode

The feature allows the imager to be linked to any Bluetooth (BT) enabled device which can accept such a connection with other devices. To implement this mode, follow these instructions:

1. Place the imager in Programming Mode by scanning the START bar code.
2. Scan the “Connect to a BT Device” bar code to put the imager in the mode enabling a link to a device other than its own Base Station.
3. Scan the END bar code to exit Programming Mode.
4. Scan the “Begin Pin” bar code.
5. Set the four- to six-character PIN code assigned to the target Bluetooth device using the bar codes available in [Appendix B, Alpha-Numeric Pad](#).
6. Scan the “Set” bar code.
7. Scan the “End Pin” bar code.
8. Use the software that drives the other BT device to scan for devices in the area. The QS6500BT imager will be displayed as "Data-logic¹ handheld scanner." Each BT device uses different methods to link, so you'll need to follow the instructions for the device being connected to.









The Serial Peripheral Protocol is the only interface supported.

NOTE



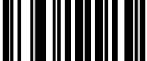

1. Depending upon when your scanner was purchased, the display might read "PSC handheld scanner."

Bluetooth Connectivity Mode – continued

START	
STATE	BARCODE
Connect to Base Station	
Connect to a BT Device	
END	
Begin Pin	
SET	
End Pin	

Inquiry Beep Control

When the Base Station is not linked to a handheld, the Radio LED will blink amber and the Base Station will beep. This beep can be disabled or reconfigured to sound for different durations by using the following programming bar codes.

START	
STATE	BARCODE
Disable Inquiry Beep	
Inquiry Beep = 10 Seconds	
Inquiry Beep = 20 Seconds	
Inquiry Beep = 30 Seconds	
Inquiry Beep = 40 Seconds	
Inquiry Beep = 50 Seconds	
Inquiry Beep = 1 Minute	
Inquiry Beep = 1.5 Minutes	
Inquiry Beep = 2 Minutes	
Inquiry Beep = 3 Minutes	
Inquiry Beep = 4 Minutes	

Inquiry Beep Control

START	
STATE	BARCODE
Inquiry Beep = 5 Minutes	
Inquiry Beep = 6 Minutes	
Inquiry Beep = 7 Minutes	
Inquiry Beep = 8 Minutes	
END	

NOTES

Chapter 8

Product Specifications

Imager Product Specifications

Parameter	Specification
Dimensions (Typical):	
Height	6.5 inches (16.5 cm)
Length	3.9 inches (9.9 cm)
Width	2.9 inches (7.4 cm)
Weight	6.0 ounces (170.1 g)
Voltage Requirements	+4.5 to 14 VDC +/- 5%
Input Power	
Operating	1250 mW: POT w/all interfaces
Standby	500 mW
Input Current	
Operating	300mA @ 5VDC
Standby	200mA @ 5VDC
Skew	± 55°
Pitch	± 65°
Temperature Ranges:	
Operating	32° F to +122° F (0° C to +50° C)
Storage	-40° F to +140° F (-40° C to + 60°C)
Humidity	0 to 95% non-condensing
Mechanical Shock	Operational after 50 drops from 5 feet (15.24 meters) to concrete
Vibration	Meets MIL-STD-810E
Contaminants	
Spray/rain	IEC 529-IPx2
Dust/particulate	IEC 529-IP5x

Standard Cable Pinouts (Primary Interface Cables)

RS-232

- 1
- 2 CTS
- 3
- 4 RTS
- 5 RXD
- 6 TXD
- 7
- 8 VCC_IN
- 9 GND
- 10

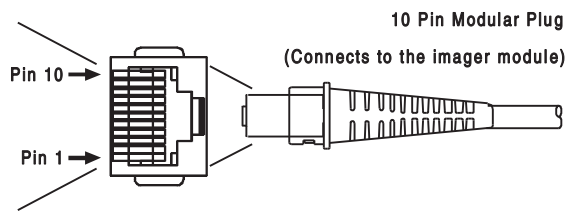

Keyboard Wedge

- 1
- 2 KBDATA
- 3 PCCLK
- 4 KBCLK
- 5 NC
- 6 PCDATA
- 7 NC
- 8 VCC_IN
- 9 GND
- 10

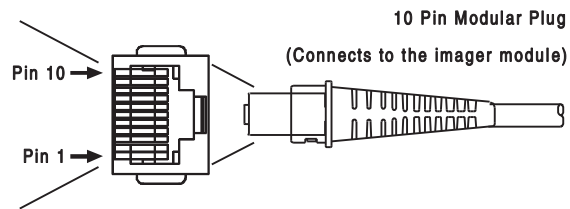

Standard Cable Pinouts (Primary Interface Cables)

USB

- 1
- 2
- 3
- 4 D-
- 5
- 6 D+
- 7
- 8 VBUS_VIN
- 9 GND
- 10

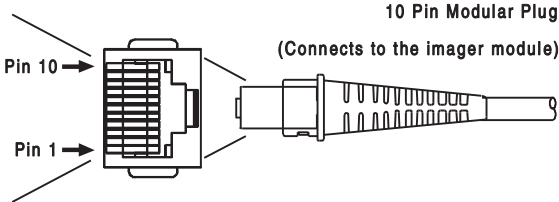

IBM Port 5B/9B/17

- 1
- 2
- 3
- 4 Serial I/O B
- 5
- 6 Serial I/O A
- 7
- 8 VCC_IN
- 9 GND
- 10

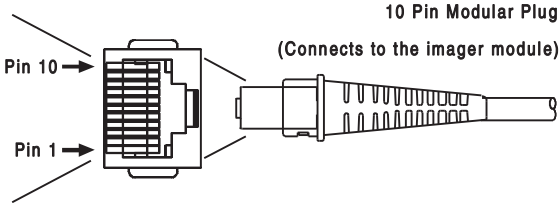

NOTES

Appendix A

ASCII Conversion Chart

ASCII Char.	Hex No.	ASCII Char.	Hex No.	ASCII Char.	Hex No.	ASCII Char.	Hex No.
NUL	00	SP	20	@	40	'	60
SOH	01	!	21	A	41	a	61
STX	02	"	22	B	42	b	62
ETX	03	#	23	C	43	c	63
EOT	04	\$	24	D	44	d	64
ENQ	05	%	25	E	45	e	65
ACK	06	&	26	F	46	f	66
BEL	07	'	27	G	47	g	67
BS	08	(28	H	48	h	68
HT	09)	29	I	49	i	69
LF	0A	*	2A	J	4A	j	6A
VT	0B	+	2B	K	4B	k	6B
FF	0C	,	2C	L	4C	l	6C
CR	0D	-	2D	M	4D	m	6D
SO	0E	.	2E	N	4E	n	6E
SI	0F	/	2F	O	4F	o	6F
DLE	10	0	30	P	50	p	70
DC1	11	1	31	Q	51	q	71
DC2	12	2	32	R	52	r	72
DC3	13	3	33	S	53	s	73
DC4	14	4	34	T	54	t	74
NAK	15	5	35	U	55	u	75
SYN	16	6	36	V	56	v	76
ETB	17	7	37	W	57	w	77
CAN	18	8	38	X	58	x	78
EM	19	9	39	Y	59	y	79
SUB	1A	:	3A	Z	5A	z	7A
ESC	1B	;	3B	[5B	{	7B
FS	1C	<	3C	\	5C		7C
GS	1D	=	3D]	5D	}	7D
RS	1E	>	3E	^	5E	~	7E
US	1F	?	3F	_	5F	DEL	7F

Appendix B

Alpha-Numeric Pad

Use the bar codes contained in this chapter to modify configuration settings as described in the feature/option descriptions.





Appendix C

Keyboard Function Key Mappings

Keyboard Model Cross Reference

Table C-2 summarizes the keyboard models, their defined protocol, scancode set, and some unique features. The remaining tables in this chapter provide the function key maps associated with each of the scancode sets.

Table C-1. USB Function Key Usage Map

ASCII	Key value	Usage Name	Modifier/ Scancode
00	NUL	ALT right Make	40h 00h
01	SOH	ALT right Break	00h 00h ¹
02	STX	F11	00h 44h
03	ETX	F12	00h 45h
04	EOT	GUI right Make	80h 00h
05	ENQ	GUI right Break	00h 00h ¹
06	ACK	CTRL right Make	10h 00h
07	BEL	CTRL right Break	00h 00h ¹
08	BS	BS	00h 2Ah
09	HT	TAB right	00h 2Bh
0A	LF	RIGHT arrow (inner keypad)	00h 4Fh
0B	VT	TAB left	02h 2Bh
0C	FF	Enter (right keypad)	00h 58h
0D	CR	CR	00h 28h
0E	SO	INSERT (inner keypad)	00h 49h
0F	SI	PAGE UP (inner keypad)	00h 4Bh
10	DLE	PAGE DOWN (inner keypad)	00h 4Eh
11	DC1	HOME (inner keypad)	00h 4Ah
12	DC2	LEFT arrow (inner keypad)	00h 50h

13	DC3	DOWN arrow (inner keypad)	00h 51h
14	DC4	UP arrow (inner keypad)	00h 52h
15	NAK	F6	00h 3Fh
16	SYN	F1	00h 3Ah
17	ETB	F2	00h 3Bh
18	CAN	F3	00h 3Ch
19	EM	F4	00h 3Dh
1A	SUB	F5	00h 3Eh
1B	ESC	ESC	00h 29h
1C	FS	F7	00h 40h
1D	GS	F8	00h 41h
1E	RS	F9	00h 42h
1F	US	F10	00h 43h

Table C-2. Keyboard Model Cross Reference

Model Type	I/F ID	Transmission Protocol	Scancode Set	Func. Key Map Support	Use Country Mode
PC/XT Foreign ALT Mode	Wedge A	PC/XT	Scan Set 1	No	No
AT; PS/2 25-286; PS/2 30-286; PS/2 50, 50Z; PS/2 60,70,80,90,95 Foreign ALT Mode	Wedge B	AT/PS2	Scan Set 2	No	No
PS/2 25 and 30 Foreign ALT Mode	Wedge C	AT/PS2	Scan Set 1	No	No
PC/XT U.S. Mode	Wedge D	PC/XT	Scan Set 1	Yes	No
AT; PS/2 25-286; PS/2 30-286; PS/2 50, 50Z; PS/2 60,70,80,90,95 U.S. Mode + specific country support	Wedge E	AT/PS2	Scan Set 2	Yes	Yes
PS/2 25 and 30 U.S. Mode	Wedge F	AT/PS2	Scan Set 1	Yes	No
IBM 3xxx Terminals (122-key keyboard)	Wedge G	AT/PS2	Scan Set 3	Yes	No

Keyboard Model Cross Reference

IBM 3xxx Terminals (102-key keyboard)	Wedge H	AT/PS2	Scan Set 3	Yes	No
PS55 5530T with JAPANESE DOS (TDOS)	Wedge I	AT/PS2	Japanese DOS	Yes	No
NEC 9801	Wedge J	NEC 9801	NEC 9801	Yes	No

Table C-3. Scanset 1 Function Key Map

ASCII (hex)	ASCII code	Key	Scancode
00	NUL	ALT right Make	E0h 38h
01	SOH	ALT right Break	E0h B8h
02	STX	ALT left Make	38h
03	ETX	ALT left Break	B8h
04	EOT	CTRL left Make	1Dh
05	ENQ	CTRL left Break	9Dh
06	ACK	CTRL right Make	E0h 1Dh
07	BEL	CTRL right Break	E0h 9Dh
08	BS	BS	0Eh
09	HT	TAB right	0Fh
0A	LF	RIGHT arrow (inner keypad)	4Dh + E0
0B	VT	TAB left	0Fh + S
0C	FF	Enter (inner keypad)	1Ch + E0
0D	CR	CR	1Ch
0E	SO	INSERT (inner keypad)	52h + E0
0F	SI	PAGE UP (inner keypad)	49h + E0
10	DLE	PAGE DOWN (inner keypad)	51h + E0
11	DC1	HOME (inner keypad)	47h + E0
12	DC2	LEFT arrow (inner keypad)	4Bh + E0
13	DC3	DOWN arrow (inner keypad)	50h + E0
14	DC4	UP arrow (inner keypad)	48h + E0

Table C-4. Scanset 2 Function Key Map

ASCII (hex)	ASCII code	Key	Scancode
00	NUL	ALT right Make	E0h 11h
01	SOH	ALT right Break	E0h F0h 11h
02	STX	ALT left Make	11h
03	ETX	ALT left Break	F0h 11h
04	EOT	CTRL left Make	14h
05	ENQ	CTRL left Break	F0h 14h
06	ACK	CTRL right Make	E0h 14h
07	BEL	CTRL right Break	E0h F0h 14h
08	BS	BS	66h
09	HT	TAB right	0Dh
0A	LF	RIGHT arrow (inner keypad)	74h + E0
0B	VT	TAB left	0Dh + S
0C	FF	Enter (right keypad)	5Ah + E0
0D	CR	CR	5Ah
0E	SO	INSERT (inner keypad)	70h + E0
0F	SI	PAGE UP (inner keypad)	7Dh + E0
10	DLE	PAGE DOWN (inner keypad)	7Ah + E0
11	DC1	HOME (inner keypad)	6Ch + E0
12	DC2	LEFT arrow (inner keypad)	6Bh + E0
13	DC3	DOWN arrow (inner keypad)	72h + E0
14	DC4	UP arrow (inner keypad)	75h + E0
15	NAK	F6	0Bh
16	SYN	F1	05h
17	ETB	F2	06h
18	CAN	F3	04h
19	EM	F4	0Ch
1A	SUB	F5	03h
1B	ESC	ESC	76h
1C	FS	F7	83h
1D	GS	F8	0Ah
1E	RS	F9	01h
1F	US	F10	09h

Keyboard Model Cross Reference

Table C-5. Scanset 3, 102-Key Function Key Map

ASCII (hex)	ASCII code	Key	Scancode
00	NUL	ALT right Make	39h
01	SOH	ALT right Break	F0h 39h
02	STX	ALT left Make	19h
03	ETX	ALT left Break	F0h 19h
04	EOT	CTRL left Make	11h
05	ENQ	CTRL left Break	F0h 11h
06	ACK	CTRL right Make	58h
07	BEL	CTRL right Break	F0h 58h
08	BS	BS	66h
09	HT	TAB right	0Dh
0A	LF	RIGHT arrow (inner keypad)	6Ah
0B	VT	TAB left	0Dh + S
0C	FF	Enter (inner keypad)	79h
0D	CR	CR	5Ah
0E	SO	INSERT (inner keypad)	67h
0F	SI	PAGE UP (inner keypad)	6Fh
10	DLE	PAGE DOWN (inner keypad)	6Dh
11	DC1	HOME (inner keypad)	6Eh
12	DC2	LEFT arrow (inner keypad)	61h
13	DC3	DOWN arrow (inner keypad)	60h
14	DC4	UP arrow (inner keypad)	63h
15	NAK	F6	2Fh
16	SYN	F1	07h
17	ETB	F2	0Fh
18	CAN	F3	17h
19	EM	F4	1Fh
1A	SUB	F5	27h
1B	ESC	ESC	08h
1C	FS	F7	37h
1D	GS	F8	3Fh
1E	RS	F9	47h
1F	US	F10	4Fh

Table C-6. Scanset 3 122-Key Function Key Map

ASCII (hex)	ASCII code	Key	Scancode
00	NUL	ALT Right Make	39h
01	SOH	ALT Right Break	F0h 39h
02	STX	ALT left Make	19h
03	ETX	ALT left Break	F0h 19h
04	EOT	CTRL left (RESET) Make only	11h
05	ENQ	CTRL left (RESET) Make/Break	11h F0h 11h
06	ACK	ONLINE Enter Make only	58h
07	BEL	ONLINE Enter Make/Break	58h F0h 58h
08	BS	BS	66h
09	HT	TAB right	0Dh
0A	LF	RIGHT arrow (inner keypad)	6Ah
0B	VT	TAB left	0Dh + S
0C	FF	CR (FIELD EXIT) Make only	5Ah F0h 5Ah
0D	CR	CR (FIELD EXIT) Make/Break	5Ah
0E	SO	INSERT (inner keypad)	65h
0F	SI	FIELD +	79h
10	DLE	FIELD -	7Ch
11	DC1	HOME (inner keypad)	62h
12	DC2	LEFT arrow (inner keypad)	61h
13	DC3	DOWN arrow (inner keypad)	60h
14	DC4	UP arrow (inner keypad)	63h
15	NAK	F6	2Fh
16	SYN	F1	07h
17	ETB	F2	0Fh
18	CAN	F3	17h
19	EM	F4	1Fh
1A	SUB	F5	27h
1B	ESC	ESC	08h
1C	FS	F7	37h
1D	GS	F8	3Fh
1E	RS	F9	47h
1F	US	F10	4Fh

Keyboard Model Cross Reference

Table C-7. Japanese DOS Function Key Map

ASCII value	ASCII code	Key	Scancode
00h	NUL	ALT right Make	31h
01h	SOH	ALT right Break	B1h
02h	STX	ALT left Make	31h
03h	ETX	ALT left Break	B1h
04h	EOT	CTRL left Make	41h
05h	ENQ	CTRL left Break	C1h
06h	ACK	CTRL right Make	41h
07h	BEL	CTRL right Break	C1h
08h	BS	BS	3Eh
09h	HT	TAB right	3Ch
0Ah	LF	RIGHT arrow (inner keypad)	4Dh
0Bh	VT	TAB left	3Ch + S
0Ch	FF	Enter (right keypad)	60h
0Dh	CR	CR	3Bh
0Eh	SO	INSERT (inner keypad)	52h
0Fh	SI	PAGE UP (inner keypad)	49h
10h	DLE	PAGE DOWN (inner keypad)	51h
11h	DC1	HOME (inner keypad)	4Ch
12h	DC2	LEFT arrow (inner keypad)	4Bh
13h	DC3	DOWN arrow (inner keypad)	4Ah
14h	DC4	UP arrow (inner keypad)	4Eh
15h	NAK	F6	6Dh
16h	SYN	F1	68h
17h	ETB	F2	69h
18h	CAN	F3	6Ah
19h	EM	F4	6Bh
1Ah	SUB	F5	6Ch
1Bh	ESC	ESC	3Dh
1Ch	FS	F7	6Eh
1Dh	GS	F8	6Fh
1Eh	RS	F9	70h
1Fh	US	F10	71h

Table C-8. NEC 9801-Key Function Key Map

ASCII value	ASCII code	Key	Scancode
00h	NUL	unused	n/a
01h	SOH	CR	1Ch
02h	STX	CAPS LOCK ON (make)	71h
03h	ETX	CAPS LOCK OFF (break)	F1h
04h	EOT	CTRL left Make	74h
05h	ENQ	CTRL left Break	F4h
06h	ACK	CTRL-C	60h
07h	BEL	n/a	n/a
08h	BS	BS	0Eh
09h	HT	TAB right	0Fh
0Ah	LF	RIGHT arrow (inner keypad)	3Ch
0Bh	VT	TAB left	0Fh + S
0Ch	FF	DELETE	39h
0Dh	CR	CR	1Ch
0Eh	SO	INSERT (inner keypad)	38h
0Fh	SI	KATAKANA LOCK ON (Make)	72h
10h	DLE	KATAKANA LOCK OFF (Break)	F2h
11h	DC1	HOME (inner keypad)	3Eh
12h	DC2	LEFT arrow (inner keypad)	3Bh
13h	DC3	DOWN arrow (inner keypad)	3Dh
14h	DC4	UP arrow (inner keypad)	3Ah
15h	NAK	F6	67h
16h	SYN	F1	62h
17h	ETB	F2	63h
18h	CAN	F3	64h
19h	EM	F4	65h
1Ah	SUB	F5	66h
1Bh	ESC	ESC	00h
1Ch	FS	F7	68h
1Dh	GS	F8	69h
1Eh	RS	F9	6Ah
1Fh	US	F10	6Bh

Appendix D

Default Settings

Defaults by Symbology

The following is a partial list of key settings for each symbology type.

Code Type	Read Enable	Checksum Verification Enable	Checksum Transmission Enable	Code ID
UPC-A	✓	✓	✓	A
UPC-E	✓	✓	✓	E
EAN-13	✓	✓	✓	F
EAN-8	✓	✓	✓	FF
RSS-14		✓	✓	R4
RSS Expanded				RX
RSS Limited		✓	✓	RL
Code 39	✓		✓	*
PharmaCode 39				A
Code 128	✓	✓		#
EAN-128				
Interleaved 2 of 5			✓	I
Industrial 2 of 5				I
Matrix 2 of 5				B
Codabar			✓	%
Code 93		✓		&
Code 11		One digit		O
MSI/Plessey		Mod 10	✓	@

Code Type	Read Enable	Checksum Verification Enable	Checksum Transmission Enable	Code ID
UK/Plessey		✓		@
Telepen				S
Standard 2 of 5			✓	S
Code 16K				
China Post				
PDF417				P
Micro PDF-417				U
UCC/EAN Composite				RC

Interface Default Exceptions

The factory default settings indicated in the programming sections (by bold text and yellow highlighting) reflect factory configuration for the RS-232 standard interface. The following tables list default exceptions by interface for the remaining available interfaces.

IBM Interfaces

IBM Interfaces include IBM-USB, IBM Port 9B, IBM Port5B and IBM Port17.

Parameter	Default Setting
IBM Interface Type	IBM Port 9B
Number of Host Transmit Buffers	One Buffer
Code I.D. Transmission	Disable
Suffix Characters	No Suffix

RS-232 Wincor/Nixdorf

Parameter	Default Setting
Interface Type	RS-232-WN
Number of Host Transmit Buffers	One Buffer
RS-232 Parity	Odd
RS-232 Hardware Control	CTS Flow Control
UCC/EAN-128 Code I.D.	'P'
Code 39 Read	Disable
Code 39 Code I.D.	'M'
Code 93 Code I.D.	'L'
Code 128 Read	Disable
Code 128 Code I.D.	'K'
Codabar Code I.D.	'N'
EAN-8 Code I.D.	'B'
EAN-13 Code I.D.	'A'
ISBN Code I.D.	'A'
Interleaved 2 of 5 Code I.D.	'I'
Standard 2 of 5 Code I.D.	'H'
MSI/Plessey Code I.D.	'O'
UPC-A Truncate/Expansion	Expand to EAN-13
UPC-E Code I.D.	'C'
PDF 417 Code I.D.	'Q'
RSS-14 Code I.D.	'E'
RSS Limited Code I.D.	'E'
RSS Expanded Code I.D.	'E'
Micro PDF 417 Code I.D.	'Q'

Keyboards

Keyboard interfaces include USB Keyboard and Keyboard Wedge A-J.

Parameter	Default Setting
Keyboard Wedge Interface Type	USB Keyboard
Code I.D. Transmission	Disable

Wand Emulation

Parameter	Default Setting
Code I.D. Transmission	Disable
Suffix Characters	No Suffix
Code 128 Function Code Transmission	Enable

Appendix E

List Commands

Parameter Settings List

The following bar codes are used to cause the scanner to display (list) its internal data at a connected terminal.



List Standard Parameter Settings

Displays the current configuration of your scanner.



List Unique Parameter Settings

Displays any unique parameter settings currently programmed into your scanner.



List String Settings

Displays any data string settings currently programmed for your scanner.



List Firmware Version

Displays the scanner's firmware version.



List Default Parameter Version

Displays the version description for the scanner's factory-programmed default parameters.



List Serial Number

Displays the scanner's serial number.

NOTES

Chapter F

LED & Beeper Indications

Bluetooth models offer a special set of LED and Beeper indications beyond the simple “Good Read” and error signals provided by corded models. These indications allow you to understand a variety of functions and features implemented for the product.

Bluetooth Imager Indications

STATUS	GREEN LED	RED LED	ORANGE LED	BEEPER
Connected or re-enter into the boundary (When scanner is sleeping)	Blink once			Special beep
Disconnected or Out of boundary (When scanner is sleeping)			Blink twice	
Disconnected or Out of boundary (Trigger is pressed only)			Blinks	
Hardware fail		Flash		
Program download	Flash			
Program checksum fail		Flash		
Scan disable (Trigger is pressed only)	Blink			Special beep
Data transmitting	ON			High freq.beep for 300msec
Data transmission Fail		ON for Xmsec		

LED & Beeper Indications

STATUS	GREEN LED	RED LED	ORANGE LED	BEEPER
Data transmission OK	ON for Xmsec			
Low battery (Trigger is pressed only)			Blinks	

Bluetooth Base Station Indications

	STATUS	GREEN LED	RED LED	ORANGE LED	BEEPER
	Inquiry			Blinking	Beeps once a second
BlueTooth Status LED	Connecting				
	Link established	ON			
	Hardware fail		Flash		
	Data receiving from the scanner			On for ~ 0.5 second	
	Bar code data proof or transmitted				Good beep (for test only)
	Data send to the host fail				Error beep (for test only)
Battery LED	Idle				
	Charging	Blinking			
	Battery full	ON			
	Battery/charger fail		Blink		
	Program download	Flash			
	Program check-sum fail		Flash		

NOTES

Appendix G

Sample Symbols

UPC-A



0 123456 7890

Interleaved 2 of 5

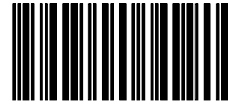

1234567890

Code 128



Code 128

EAN-13

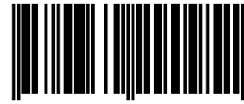

9 780330 290951

Code 39

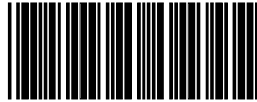

BC321

Codabar

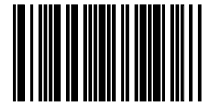

A13579B

Code 93



123456-9\$

Industrial Code 2 of 5

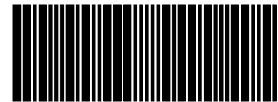

123456

Sample Symbols – continued

Matrix 2 of 5



6543210

RSS-14

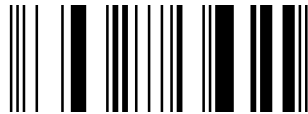

(01)00123456789012

Sample Symbols for PDF Models ONLY

Micro PDF417



Test Message

PDF417



Car Registration

This equipment has been tested and found to comply with the limits for a Class B digital device, pursuant to part 15 of the FCC rules. These limits are designed to provide reasonable protection against harmful interference in a residential installation. This equipment generates, uses and can radiate radio frequency energy and, if not installed and used in accordance with the instructions, may cause harmful interference to radio communications. However, there is no guarantee that interference will not occur in a particular installation. If this equipment does cause harmful interference to radio or television reception, which can be determined by turning the equipment off and on, the user is encouraged to try to correct the interference by one or more of the following measures:

- Reorient or relocate the receiving antenna.
- Increase the separation between the equipment and receiver.
- Connect the equipment into an outlet on a circuit different from that to which the receiver is connected.
- Consult the dealer or an experienced radio/TV technician for help.

You are cautioned that changes or modifications not expressly approved by the party responsible for compliance could void your authority to operate the equipment.

This device complies with Part 15 of the FCC Rules. Operation is subject to the following two conditions: (1) this device may not cause harmful interference and (2) this device must accept any interference received, including interference that may cause undesired operation

FCC RF Radiation Exposure Statement:

1. This Transmitter must not be co-located or operating in conjunction with any other antenna or transmitter.

Australia

Datalogic Scanning Pty Ltd
Telephone: [61] (2) 9870 3200
australia.scanning@datalogic.com

Japan

Datalogic Scanning KK
Telephone: 81 (0)3 3491 6761
japan.scanning@datalogic.com

France and Benelux

Datalogic Scanning Sarl
Telephone: [33].01.64.86.71.00
france.scanning@datalogic.com

Latin America

Datalogic Scanning, Inc
Telephone: (305) 591-3222
latinamerica.scanning@datalogic.com

Germany

Datalogic Scanning GmbH
Telephone: 49 (0) 61 51/93 58-0
germany.scanning@datalogic.com

Singapore

Datalogic Scanning Singapore PTE LTD
Telephone: (65) 6435-1311
singapore.scanning@datalogic.com

India

Datalogic Scanning India
Telephone: 91- 22 - 64504739
india.scanning@datalogic.com

Spain and Portugal

Datalogic Scanning Sarl Sucursal en España
Telephone: 34 91 746 28 60
spain.scanning@datalogic.com

Italy

Datalogic Scanning SpA
Telephone: [39] (0) 39/62903.1
italy.scanning@datalogic.com

United Kingdom

Datalogic Scanning LTD
Telephone: 44 (0) 1923 809500
uk.scanning@datalogic.com



www.scanning.datalogic.com

Datalogic Scanning, Inc.

959 Terry Street
Eugene, OR 97402
Telephone: (541) 683-5700
Fax: (541) 345-7140

