

Datalogic Memor™

USER'S MANUAL



DATALOGIC

DATALOGIC S.p.A.
Via Candini 2
40012 - Lippo di Calderara di Reno
Bologna - Italy

Datalogic Memor™ - User's Manual

Ed.: 09/2006

ALL RIGHTS RESERVED

Datalogic reserves the right to make modifications and improvements without prior notification.

Datalogic shall not be liable for technical or editorial errors or omissions contained herein, nor for incidental or consequential damages resulting from the use of this material.

Product names mentioned herein are for identification purposes only and may be trademarks and or registered trademarks of their respective companies.

© Datalogic S.p.A. 2006

822000700

CONTENTS

	DATALOGIC END USER LICENSE AGREEMENT	v
	REFERENCES.....	vii
	Conventions	vii
	Reference Documentation	vii
	Services and Support.....	vii
	SAFETY REGULATIONS	viii
	General Safety Rules	viii
	Laser Safety	ix
	LED Illuminator	xii
	Radio Compliance.....	xii
	Information for the User.....	xiii
	WEEE Compliance.....	xiii
	GENERAL VIEW.....	xiv
1	INTRODUCTION.....	1
1.1	Datalogic Memor™ Description	1
1.2	Model Description	2
1.3	Package Contents	2
1.4	Inserting an SD card	3
1.5	Accessories.....	4
2	CONNECTIONS.....	5
2.1	Connection to the Host Computer.....	5
2.1.1	USB Connection.....	5
2.1.2	RS232 Connection	6
2.1.3	WLAN Connection.....	7
2.1.4	WPAN Connections	8
2.2	Connection Cables.....	9
3	USE AND FUNCTIONING	10
3.1	Startup.....	10
3.1.1	Using the Stylus	11
3.1.2	Using the Joystick	11
3.2	Data Capture	12
3.2.1	Laser Data Capture.....	12
3.3	Description of the Keys	13
	Main Keys Function.....	14
	Keyboard Photosensing System	14
	Special Function Icons	15
	Hardware and Software Reset	15
3.4	Status Indicators	16
3.4.1	LED Status	16
3.4.2	Status Bar	17
3.5	Data Capture Configuration.....	18
3.5.1	Configure.....	18
	Reader Parameters.....	20

	Scan Parameters	20
	Default Settings	21
3.5.2	Capture	22
3.6	Control Panel	23
3.6.1	Buttons	23
3.6.2	Registry	24
3.6.3	Files Admin	25
3.6.4	Wireless Communications	27
3.7	Windows Connections	28
3.7.1	Microsoft® ActiveSync®	28
	ActiveSync® Remote	29
3.7.2	Bluetooth® Manager Device Setup	30
3.8	Backup Directory File Management	32
4	MAINTENANCE	33
4.1	Connecting the Backup Battery	33
4.2	Charging the Battery Pack	34
4.3	Replacing the Battery Pack	35
4.4	Cleaning the Mobile Computer	36
5	TECHNICAL FEATURES	37
5.1	Technical Data	37
6	TEST CODES	39
	GLOSSARY	42
	INDEX	44

DATALOGIC END USER LICENSE AGREEMENT

BY DOWNLOADING OR INSTALLING THE SOFTWARE, OR BY USING DATALOGIC EQUIPMENT THAT INCLUDES THIS SOFTWARE, YOU ARE CONSENTING TO BE BOUND BY THIS AGREEMENT. IF YOU DO NOT AGREE TO ALL OF THE TERMS OF THIS AGREEMENT, THEN DO NOT DOWNLOAD, INSTALL, USE THE SOFTWARE NOR DATALOGIC EQUIPMENT.

The following terms and conditions govern your use of the Software except to the extent that a particular program (a) is the subject of a separate written agreement with Datalogic or (b) includes a separate "click-on" license agreement as part of the installation and/or download process. Should a conflict arise between the provisions of the foregoing documents, the order of precedence shall be (1) the written agreement, (2) the click-on agreement, and (3) this agreement ("Agreement").

1. License. Subject to the terms and conditions of and except as otherwise provided in this Agreement, Datalogic S.p.A. ("Datalogic") and its suppliers grant to Customer ("Customer") a nonexclusive and nontransferable license to use the specific program modules, feature set(s) or feature(s) in object code form only as well as associated media, printed materials and "online" or electronic documentation (the "Software") for which Customer has paid, if required, the license fees. The Software is licensed not sold. The license shall be subject to each of the following limitations:

- Unless otherwise expressly provided in the documentation, Customer shall use the Software solely as embedded in, for execution on, or (where the applicable documentation permits installation on non-Datalogic equipment) for communication with Datalogic equipment owned or leased by Customer;
- Customer's use of the Software shall be limited to use on a single hardware chassis, on a single central processing unit, as applicable, or use on such greater number of chassis or central processing units as Customer may have paid Datalogic the required license fee; and
- Customer's use of the Software shall also be limited, as applicable and set forth in Customer's purchase order or in Datalogic's product catalog, user documentation, or web site, to a maximum number of (a) seats (i.e. users with access to the installed Software), (b) concurrent users, sessions, ports, and/or issued and outstanding IP addresses, and/or (c) central processing unit cycles or instructions per second. Customer's use of the Software shall also be limited by any other restrictions set forth in Customer's purchase order or in Datalogic's product catalog, user documentation or web site for the Software.

2. General Limitations. Except as otherwise expressly provided under this Agreement, Customer shall have no right, and Customer specifically agrees not to (i) transfer, assign or sublicense its license rights to any other person, or use the Software on unauthorized or secondhand Datalogic equipment, and any such attempted transfer, assignment or sublicense shall be void; (ii) correct errors to or otherwise modify or adapt the Software or create derivative works based upon the Software, or to permit third parties to do the same; or (iii) decompile, decrypt, reverse engineer, disassemble or otherwise reduce the Software to human-readable form to gain access to trade secrets or confidential information in the Software. To the extent required by law, at Customer's request, Datalogic shall provide Customer with the interface information needed to achieve interoperability between the Software and another independently created program, upon payment of Datalogic's applicable fee. Customer shall observe strict obligations of confidentiality with respect to such information.

3. Upgrades and Additional Copies. For purposes of this Agreement, "Software" shall include (and the terms and conditions of this Agreement shall apply to) any upgrades, updates, bug fixes or modified versions (collectively, "Upgrades") or backup copies of the Software licensed or provided to Customer by Datalogic or an authorized distributor for which Customer has paid the applicable license fees. Notwithstanding any other provision of this Agreement: (1) customer has no license or right to use any such additional copies or upgrades unless customer, at the time of acquiring such copy or upgrade, already holds a valid license to the original Software and has paid the applicable fee for the upgrade, if required; (2) use of upgrades is limited to Datalogic equipment for which customer is the original end user, purchaser or lessee or who otherwise holds a valid license to use the Software which is being upgraded; and (3) use of additional copies is limited to backup purposes only.

4. Proprietary Notices. Customer agrees to maintain and reproduce all copyright and other proprietary notices on all copies, in any form, of the Software in the same form and manner that such copyright and other proprietary notices are included on the Software. Except as expressly authorized in this Agreement, Customer shall not make any copies or duplicates of any Software without the prior written permission of Datalogic. Customer may make such backup copies of the Software as may be necessary for Customer's lawful use, provided Customer affixes to such copies all copyright, confidentiality, and proprietary notices that appear on the original.

5. Protection of Information. Customer agrees that aspects of the Software and associated documentation, including the specific design and structure of individual programs, constitute trade secrets

and/or copyrighted material of Datalogic. Customer shall not disclose, provide, or otherwise make available such trade secrets or copyrighted material in any form to any third party without the prior written consent of Datalogic. Customer shall implement reasonable security measures to protect such trade secrets and copyrighted material. Software and documentation shall remain solely property of Datalogic.

6. Limited Warranty. If Customer obtained the Software directly from Datalogic, then Datalogic warrants that during the Warranty Period (as defined below): (i) the media on which the Software is furnished will be free of defects in materials and workmanship under normal use; and (ii) the Software will substantially conform to its published specifications. The "Warranty Period" means a period beginning on the date of Customer's receipt of the Software and ending on the later of (a) ninety (90) days from the date of initial shipment of the Software by Datalogic, or (b) the end of the minimum period required by the law of the applicable jurisdiction. The limited warranties extend only to Customer as the original licensee. Customer's sole and exclusive remedy and the entire liability of Datalogic and its suppliers under these limited warranties will be, at Datalogic's sole option, repair or replacement of the Software if reported (or, upon request, returned) to Datalogic. Except as expressly granted in this Agreement, the Software is provided **AS IS** and with all faults. Datalogic does not warrant that the Software is error free or that Customer will be able to operate the Software without problems or interruptions. In addition, due to the continual development of new techniques for intruding upon and attacking networks, Datalogic does not warrant that the Software or any equipment, system or network on which the Software is used will be free of vulnerability to intrusion or attack. This warranty does not apply if the Software (a) is licensed for beta, evaluation, testing or demonstration purposes for which Datalogic does not receive a license fee, (b) has been altered, except by Datalogic, (c) has not been installed, operated, repaired, or maintained in accordance with instructions supplied by Datalogic, (d) has been subjected to abnormal physical or electrical stress, misuse, negligence, or accident, or (e) is used in ultra hazardous activities. If Customer obtained the Software from a Datalogic reseller, the terms of any warranty shall be as provided by such distributor, and Datalogic provides Customer no warranty with respect to such Software. The Software may contain support for programs written in Java. Java technology is not fault tolerant and is not designed, manufactured, or intended for use or resale as online control equipment in hazardous environments requiring fail-safe performance, such as in the operation of nuclear facilities, aircraft navigation or communication systems, air traffic control, direct life support machines, or weapons systems, in which the failure of Java technology could lead directly to death, personal injury, or severe physical or environmental damage. Microsoft Inc. has contractually obligated Datalogic to make this disclaimer.

7. Disclaimer of Warranties. Except as specified in this warranty, all expressed or implied conditions, representations, and warranties including, without limitation, any implied warranty or condition of merchantability, fitness for a particular purpose, non-infringement, satisfactory quality or arising from a course of dealing, usage, or trade practice, are hereby excluded to the extent allowed by applicable law. To the extent that an implied warranty cannot be excluded, such warranty is limited in duration to the warranty period.

8. Disclaimer of Liabilities. In no event will Datalogic or its suppliers be liable for any lost revenue, profit, or data, or for special, indirect, consequential, incidental, or punitive damages however caused and arising out of the use of or inability to use the Software even if Datalogic has been advised of the possibility of such damages. In no event shall Datalogic or its suppliers' liability to customer, whether in contract, tort (including negligence), or otherwise, exceed the price paid by customer. The foregoing limitations shall apply even if the above-stated warranty fails of its essential purpose.

9. Term and Termination. This Agreement is effective until terminated. Customer may terminate this Agreement at any time by destroying all copies of Software including any documentation. Customer's license rights under this Agreement will terminate immediately without notice from Datalogic if Customer fails to comply with any provision of this Agreement. Upon termination, Customer must destroy all copies of Software in its possession or control.

10. Customer Records. Customer grants to Datalogic and its independent accountants the right to examine Customer's books, records and accounts during Customer's normal business hours to verify compliance with this Agreement. In the event such audit discloses non-compliance with this Agreement, Customer shall promptly pay to Datalogic the appropriate license fees.

11. General Provisions. This Agreement shall be governed by and construed in accordance with the laws of Italy. All disputes arising out of or in connection with this Agreement will be subject to the exclusive jurisdiction of the competent Court of the place where Datalogic has its registered office. If any portion hereof is found to be void or unenforceable, the remaining provisions of this Agreement shall remain in full force and effect. Except as expressly provided herein, this Agreement constitutes the entire agreement between the parties with respect to the license of the Software and supercedes any conflicting or additional terms contained in the purchase order.

DATALOGIC



REFERENCES

CONVENTIONS

This manual uses the following conventions:

"User" refers to anyone using a Datalogic Memor™ mobile computer.

"Mobile computer" and "Datalogic Memor™" refer to Datalogic Memor™ mobile computer.

"You" refers to the System Administrator or Technical Support person using this manual to install, configure, operate, maintain or troubleshoot a Datalogic Memor™ mobile computer.

REFERENCE DOCUMENTATION

For further information regarding Datalogic Memor™ refer to the SDK Help on-Line.

SERVICES AND SUPPORT

Datalogic provides several services as well as technical support through its website.

Log on to www.datalogic.com and click on the [links](#) indicated for further information including:

- **PRODUCTS**

Search through the links to arrive at your product page where you can download specific **Manuals** and **Software & Utilities**

- **SERVICES & SUPPORT**

- **Datalogic Services** Warranty Extensions and Maintenance Agreements

- **Authorised Repair Centres**

- **CONTACT US**

E-mail form and listing of Datalogic Subsidiaries

SAFETY REGULATIONS



NOTE

Read this manual carefully before performing any type of connection to the Datalogic Memor™ mobile computer. The user is responsible for any damages caused by incorrect use of the equipment or by inobservance of the indication supplied in this manual.

GENERAL SAFETY RULES

- Use only the components supplied by the manufacturer for the specific Datalogic Memor™ being used.
- Do not attempt to disassemble the Datalogic Memor™ mobile computer, as it does not contain parts that can be repaired by the user. Any tampering will invalidate the warranty.
- When replacing the battery pack or at the end of the operative life of the Datalogic Memor™ mobile computer, disposal must be performed in compliance with the laws in force.
- Do not submerge the Datalogic Memor™ in liquid products.

LASER SAFETY

The laser light is visible to the human eye and is emitted from the window indicated in the figure.

This information applies to both laser models and the Datalogic Memor™ Imager Aiming System.

Laser output window



I	D	F	E
La luce laser è visibile all'occhio umano e viene emessa dalla finestra indicata nella figura.	Die Laserstrahlung ist für das menschliche Auge sichtbar und wird am Strahlaustrittsfenster ausgesendet (siehe Bild).	Le rayon laser est visible à l'oeil nu et il est émis par la fenêtre désignée sur l'illustration dans la figure.	La luz láser es visible al ojo humano y es emitida por la ventana indicada en la figura.
LUCE LASER NON FISSARE IL FASCIO APPARECCHIO LASER DI CLASSE 2 MINIMA POTENZA DI USCITA: LUNGHEZZA D'ONDA EMESSA: CONFORME A EN 60825-1 (2001)	LASERSTRAHLUNG NICHT IN DER STRAHL BLINKEN PRODUKT DER LASERKLASSE 2 MAXIMALE AUSGANGLEISTUNG: WELLENLÄNGE: ENTSPR. EN 60825-1 (2001)	RAYON LASER EVITER DE REGARDER LE RAYON APPAREIL LASER DE CLASSE 2 PUISSANCE DE SORTIE: LONGUER D'ONDE EMISE: CONFORME A EN 60825-1 (2001)	RAYO LÁSER NO MIRAR FIJO EL RAYO APARATO LÁSER DE CLASE 2 MÁXIMA POTENCIA DE SALIDA: LONGITUD DE ONDA EMITIDA: CONFORME A EN 60825-1 (2001)

ENGLISH

The following information is provided to comply with the rules imposed by international authorities and refers to the correct use of your mobile computer.

STANDARD LASER SAFETY REGULATIONS

This product conforms to the applicable requirements of both CDRH 21 CFR 1040 and EN 60825-1 at the date of manufacture.

For installation, use and maintenance, it is not necessary to open the device.



CAUTION

Use of controls or adjustments or performance of procedures other than those specified herein may result in exposure to hazardous visible laser light.

The product utilizes a low-power laser diode. Although staring directly at the laser beam momentarily causes no known biological damage, avoid staring at the beam as one would with any very strong light source, such as the sun. Avoid that the laser beam hits the eye of an observer, even through reflective surfaces such as mirrors, etc.

ITALIANO

Le seguenti informazioni vengono fornite dietro direttive delle autorità internazionali e si riferiscono all'uso corretto del terminale.

NORMATIVE STANDARD PER LA SICUREZZA LASER

Questo prodotto risulta conforme alle normative vigenti sulla sicurezza laser alla data di produzione: CDRH 21 CFR 1040 e EN 60825-1.

Non si rende mai necessario aprire l'apparecchio per motivi di installazione, utilizzo o manutenzione.



ATTENZIONE

L'utilizzo di procedure o regolazioni differenti da quelle descritte nella documentazione può provocare un'esposizione pericolosa a luce laser visibile.

Il prodotto utilizza un diodo laser a bassa potenza. Sebbene non siano noti danni riportati dall'occhio umano in seguito ad una esposizione di breve durata, evitare di fissare il raggio laser così come si eviterebbe qualsiasi altra sorgente di luminosità intensa, ad esempio il sole. Evitare inoltre di dirigere il raggio laser negli occhi di un osservatore, anche attraverso superfici riflettenti come gli specchi.

DEUTSCH

Die folgenden Informationen stimmen mit den Sicherheitshinweisen überein, die von internationalen Behörden auferlegt wurden, und sie beziehen sich auf den korrekten Gebrauch vom Terminal.

NORM FÜR DIE LASERSICHERHEIT

Dies Produkt entspricht am Tag der Herstellung den gültigen EN 60825-1 und CDRH 21 CFR 1040 Normen für die Lasersicherheit.

Es ist nicht notwendig, das Gerät wegen Betrieb oder Installations-, und Wartungs-Arbeiten zu öffnen.



ACHTUNG

Jegliche Änderungen am Gerät sowie Vorgehensweisen, die nicht in dieser Betriebsanleitung beschrieben werden, können ein gefährliches Laserlicht verursachen.

Der Produkt benutzt eine Laserdiode. Obwohl zur Zeit keine Augenschäden von kurzen Einstrahlungen bekannt sind, sollten Sie es vermeiden für längere Zeit in den Laserstrahl zu schauen, genauso wenig wie in starke Lichtquellen (z.B. die Sonne). Vermeiden Sie es, den Laserstrahl weder gegen die Augen eines Beobachters, noch gegen reflektierende Oberflächen zu richten.

FRANÇAIS

Les informations suivantes sont fournies selon les règles fixées par les autorités internationales et se réfèrent à une correcte utilisation du terminal.

NORMES DE SECURITE LASER

Ce produit est conforme aux normes de sécurité laser en vigueur à sa date de fabrication: CDRH 21 CFR 1040 et EN 60825-1.

Il n'est pas nécessaire d'ouvrir l'appareil pour l'installation, l'utilisation ou l'entretien.



ATTENTION

L'utilisation de procédures ou réglages différents de ceux donnés ici peut entraîner une dangereuse exposition à lumière laser visible.

Le produit utilise une diode laser. Aucun dommage aux yeux humains n'a été constaté à la suite d'une exposition au rayon laser. Eviter de regarder fixement le rayon, comme toute autre source lumineuse intense telle que le soleil. Eviter aussi de diriger le rayon vers les yeux d'un observateur, même à travers des surfaces réfléchissantes (miroirs, par exemple).

ESPAÑOL

Las informaciones siguientes son presentadas en conformidad con las disposiciones de las autoridades internacionales y se refieren al uso correcto del terminal.

NORMATIVAS ESTÁNDAR PARA LA SEGURIDAD LÁSER

Este aparato resulta conforme a las normativas vigentes de seguridad láser a la fecha de producción: CDRH 21 CFR 1040 y EN 60825-1.

No es necesario abrir el aparato para la instalación, la utilización o la manutención.

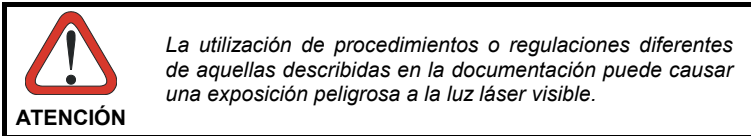

El aparato utiliza un diodo láser a baja potencia. No son notorios daños a los ojos humanos a consecuencia de una exposición de corta duración. Eviten de mirar fijo el rayo láser así como evitarían cualquiera otra fuente de luminosidad intensa, por ejemplo el sol. Además, eviten de dirigir el rayo láser hacia los ojos de un observador, también a través de superficies reflectantes como los espejos.

LED Illuminator

The use of an illuminator in the Datalogic Memor™ CCD scanner model is a Class 1 LED product:

ILLUMINATORE LED CLASSE 1

AUSLEUCHTER LED KLASSE 1

ILLUMINATEUR A LED DE CLASSE 1

ILUMINADOR LED DE CLASE 1

RADIO COMPLIANCE

In radio systems configured with mobile computers and access points, the frequencies to be used must be allowed by the spectrum authorities of the specific country in which the installation takes place. Be absolutely sure that the system frequencies are correctly set to be compliant with the spectrum requirements of the country.

The Radio components used in this product automatically adapt to the frequencies set by the system and do not require any parameter settings.

The following shows the correspondence between the Datalogic Memor™ models and the Radio components:

- Datalogic Memor™ 6XX-XXX-XXX 802.11b/g radio

Information for the User

ENGLISH

Contact the competent authority responsible for the management of radio frequency devices of your country to verify the eventual necessity of a user license. Refer to the web site <http://europa.eu.int/comm/enterprise/rtte/spectr.htm> for further information.

ITALIANO

Prendi contatto con l'autorità competente per la gestione degli apparati a radio frequenza del tuo paese, per verificarne l'eventuale necessità della licenza d'uso. Inoltre puoi trovare ulteriori informazioni al sito: <http://europa.eu.int/comm/enterprise/rtte/spectr.htm>.

FRANÇAIS

Contactez l'autorité compétente en la gestion des appareils à radio fréquence de votre pays pour vérifier la nécessité du permis d'usage. Pour tout renseignement vous pouvez vous adresser au site web: <http://europa.eu.int/comm/enterprise/rtte/spectr.htm>.

DEUTSCH

Um die Notwendigkeit der Verwendungslizenz zu prüfen, wenden Sie sich an die Behörde, die auf der Radiofrequenzgerätsführung Ihres Lands bewandert ist. Weitere Informationen sind verfügbar auf dem Web Site: <http://europa.eu.int/comm/enterprise/rtte/spectr.htm>.

ESPAÑOL

Contacta con la autoridad competente para la gestión de los dispositivos de radio frecuencia de tu país, para verificar si es necesario la licencia de uso. Además se puede encontrar mas información en el sitio web: <http://europa.eu.int/comm/enterprise/rtte/spectr.htm>.



WEEE COMPLIANCE



Federal Communication Commission Interference Statement

This equipment has been tested and found to comply with the limits for a Class B digital device, pursuant to Part 15 of the FCC Rules. These limits are designed to provide reasonable protection against harmful interference in a residential installation. This equipment generates, uses and can radiate radio frequency energy and, if not installed and used in accordance with the instructions, may cause harmful interference to radio communications. However, there is no guarantee that interference will not occur in a particular installation. If this equipment does cause harmful interference to radio or television reception, which can be determined by turning the equipment off and on, the user is encouraged to try to correct the interference by one of the following measures:

- Reorient or relocate the receiving antenna.
- Increase the separation between the equipment and receiver.
- Connect the equipment into an outlet on a circuit different from that to which the receiver is connected.
- Consult the dealer or an experienced radio/TV technician for help.

FCC Caution: Any changes or modifications not expressly approved by the party responsible for compliance could void the user's authority to operate this equipment.

This device complies with Part 15 of the FCC Rules. Operation is subject to the following two conditions: (1) This device may not cause harmful interference, and (2) this device must accept any interference received, including interference that may cause undesired operation.

IMPORTANT NOTE:

FCC Radiation Exposure Statement:

This equipment complies with FCC radiation exposure limits set forth for an uncontrolled environment. This equipment should be installed and operated with minimum distance 20cm between the radiator & your body.

This transmitter must not be co-located or operating in conjunction with any other antenna or transmitter.

The availability of some specific channels and/or operational frequency bands are country dependent and are firmware programmed at the factory to match the intended destination. The firmware setting is not accessible by the end user.



COMPLIES WITH
PART 15 OF
THE FCC RULES

*Please Note that FCC ID OMJ0018 is for DL-MEMOR 001-904-416 (include Bluetooth Function) Model.
FCC ID OMJ0022 is for DL-MEMOR 600-904-416 (include WLAN) Model.*

GENERAL VIEW



- | | |
|---------------------------------------|----------------------------------|
| A) Transflective 64K Color Display | F) Keyboard |
| B) Good Read or User Programmable LED | G) Radio Status LED |
| C) Charging Status LED | H) Strap with Stylus Holder |
| D) Backlight Control Photosensor | I) Laser Safety Label |
| E) Scan Key | J) Product Label (under battery) |
| | K) Battery Pack |
| | L) ON/OFF Power Key |



- M) Data Capture/Laser Output Window

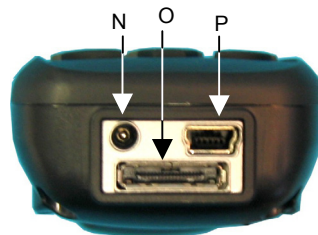

- N) DC Charger Connector
- O) Communication/Charger Connector (through cradle)
- P) Mini USB Communication/Charger Connector (through cable)

1 INTRODUCTION

1.1 DATALOGIC MEMOR™ DESCRIPTION

The Datalogic Memor™ is a pocket-sized Windows powered mobile computer.

This extremely compact, lightweight, and versatile device, combines fully integrated automatic data capture (1D bar code) and wireless communication capabilities (Bluetooth® or 802.11 b/g), supporting nearly any application.

The Datalogic Memor™ system architecture is based on the blend of Intel X-Scale series processors coupled with the Windows CE operating system and it was developed to meet the most demanding customer needs.

A huge quantity of on-board memory is available and the possibility to expand it through an externally accessible SD card slot, enables the user to adapt the terminal for any specific need.

A customized layout keyboard and a sharp and brilliant touch screen display make the Datalogic Memor™ an easy-to-use tool for your daily work.

Thanks to its great ergonomics and the state of the art architecture, the Datalogic Memor™ is the right answer to enhance your business opportunities.

1.2 MODEL DESCRIPTION

The brand new Datalogic Memor™ is available in different models depending on the options it is equipped with. All options are listed below:

- communication options: 802.11 b/g radio, Bluetooth®
- capture options: CCD, Laser

For further details about the Datalogic Memor™ models refer to the web site: <http://www.datalogic.com>.

1.3 PACKAGE CONTENTS

The Datalogic Memor™ package contains:

- 1 Datalogic Memor™ mobile computer
- 1 AC/DC power supply
- 1 standard Mini USB cable
- 1 CD-ROM Datalogic-NET SDK (Windows CE 5.0 SDK for Datalogic mobile computers)
- 1 extensible stylus
- 1 user's manual
- 1 rechargeable standard 1000 mAh battery pack + cover
- 1 hand-strap with stylus holder

Any other packages will contain the accessories necessary for the Datalogic Memor™ connection to the host computer and to the network: the cradle, one or more connection cables.

Remove all the components from their packaging; check their integrity and congruity with the packing documents.

**CAUTION**

Keep the original packaging for use when sending products to the technical assistance center. Damage caused by improper packaging is not covered under the warranty.

**NOTE**

Rechargeable backup batteries and battery packs are not initially charged. Therefore the initial operation to perform is to charge them. See paragraphs 4.1 and 4.2.

1.4 INSERTING AN SD CARD

Datalogic Memor™ provides the possibility to add an SD memory storage card. To access the SD card slot and to insert the card, proceed as follows:

1. Extract the SD card slot cover from side of the mobile computer. Then carefully pull it out till unlocking its base as shown in the picture below:



2. Insert the card with the written part upward and push it in, aided by the back of the stylus, until it clicks into place.



To remove the SD card, just push it toward the inside, aided by the back of the stylus, until it clicks; a spring system will return it out.

1.5 ACCESSORIES

❑ Cradles

94A151111 Datalogic Memor™ Single Cradle with spare battery slot; RS232 and USB communications

❑ Batteries

94ACC1326 Datalogic Memor™ Standard Battery Pack (Li-Ion battery pack 1000 mAh@3.7 V) + cover

94ACC1325 Datalogic Memor™ Large Capacity Battery Pack (Li-Ion battery pack 2000 mAh@3.7 V) + cover

94ACC1327 Adapter for 3 AAA Alkaline batteries + cover

❑ Power Supply

94ACC1324 PG5-30P35 AC/DC Power Supply EU/USA Plug

❑ Cables

94A051016 CAB-421 Mini USB Straight Cable

94A051022 WIN-NET Serial Cable (HRS ST40X-18S-CV)

❑ Various

94ACC1328 Datalogic Memor™ Stylus Pens (10 pcs)

2 CONNECTIONS

2.1 CONNECTION TO THE HOST COMPUTER

2.1.1 USB Connection

You can use any standard mini USB cable to directly connect the Datalogic Memor™ to a host computer to transfer data through the USB interface.



Key:

- | | | | |
|---|-------------------------|---|------------------|
| A | Host Computer | C | Datalogic Memor™ |
| B | Standard Mini USB cable | | |

The Datalogic Memor™ Single Cradle can be connected to the Host by any standard mini USB cable to transfer data through the USB interface.

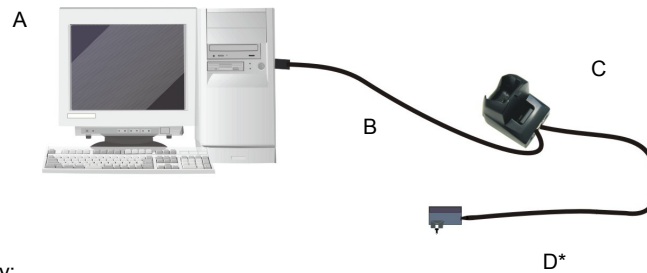

Key:

- | | | | |
|---|-------------------------|---|---|
| A | Host Computer | C | Datalogic Memor™ Single Cradle |
| B | Standard Mini USB cable | D | *Power Supply (only necessary for battery charging) |

In this case the power supply is only necessary for battery charging. Insert the power supply plug into the power jack on the base of the cradle and attach the power supply to a power outlet.

2.1.2 RS232 Connection

You can use a cable to directly connect the Datalogic Memor™ to a host computer to transfer data through the RS232 interface.



Key:

- | | | | |
|---|---|---|------------------|
| A | Host Computer | C | Datalogic Memor™ |
| B | 94A051022 WIN-NET
(HRS ST40X-18S-CV) | | |

The Datalogic Memor™ Single Cradle can be connected to the Host by any standard 9-pin serial null-modem cable for RS232 communications.

Once the Host has been turned on, insert the Datalogic Memor™ mobile computer into the cradle.

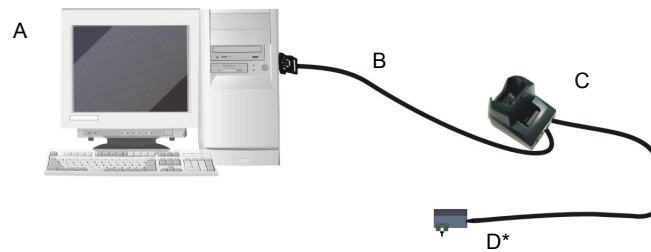

Key:

- | | | | |
|---|---------------------------------|---|--|
| A | Host Computer | C | Datalogic Memor™ Single Cradle |
| B | 94A051020 CAB-427
Null-Modem | D | *Power Supply (only necessary for
battery charging) |

In this case the power supply is only necessary for battery charging. Insert the power supply plug into the power jack on the base of the cradle and attach the power supply to a power outlet.

2.1.3 WLAN Connection

Datalogic Memor™ 802.11 b/g radio models can communicate with the host using the on-board radio frequency component and an Access Point connected to the host computer.

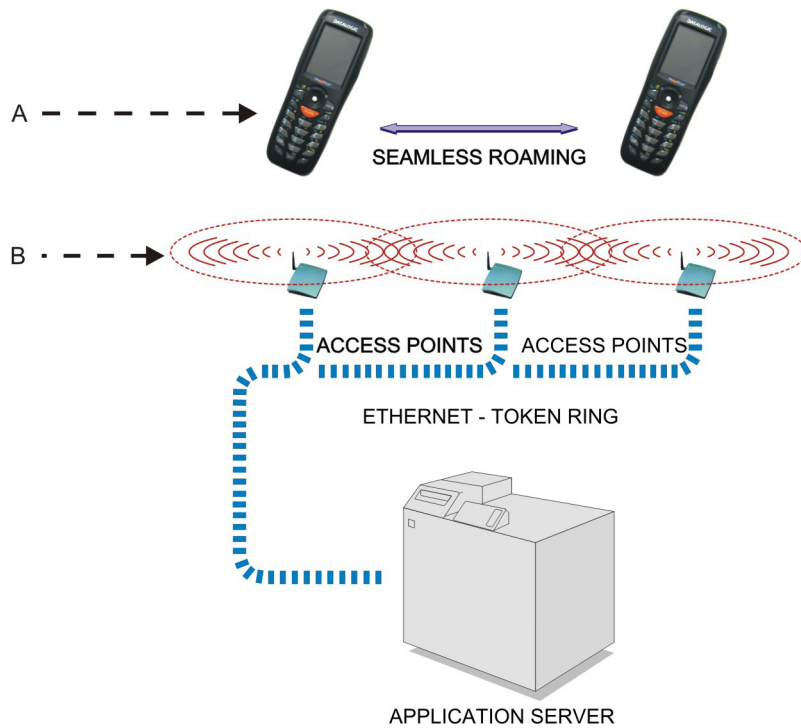

Key:

- A) Datalogic Memor™
- B) Access Point

 NOTE	<p><i>In order to avoid wasting power, the radio is off by default. If you need to have the radio working, it must be powered on using the Wireless Communications applet (see par. 3.6.4). To start configuring your WLAN connection, tap the Wi-Fi icon at the bottom of the screen.</i></p>
--	--

2.1.4 WPAN Connections

Bluetooth® Datalogic Memor™ mobile computer models can communicate with a Bluetooth® device, such as a printer, within a range of 10 m, using the on-board Bluetooth® module.

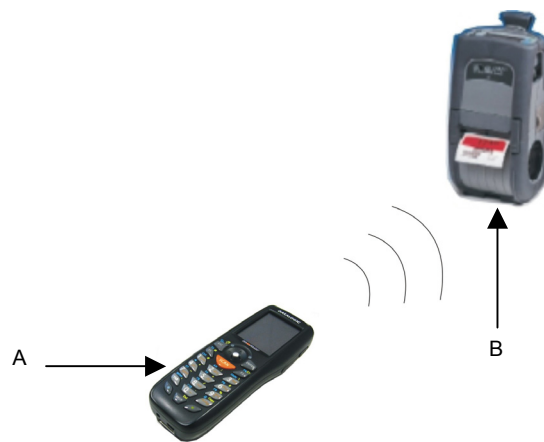

Key:

- A) Datalogic Memor™
- B) Bluetooth® printer



NOTE

In order to avoid wasting power, the Bluetooth® module is off by default. If you need to have Bluetooth® working, the module must be powered on using the Wireless Communications applet (see par. 3.6.4), and perform the Discovery procedure (see par. 3.7.2).

2.2 CONNECTION CABLES

The following cable contains its order number.

- **RS232 Direct Connection:**
94A051022 WIN-NET SERIAL CAB (HRS ST40x-18S-CV)

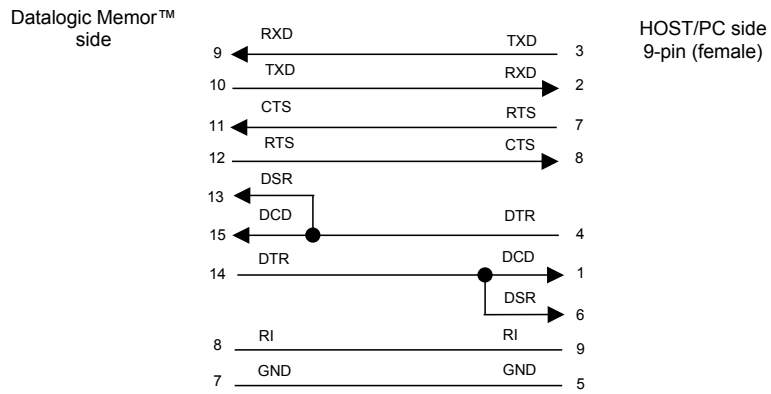

- **Power Supply Polarity:**

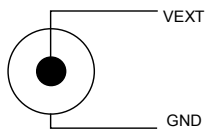

3 USE AND FUNCTIONING

The use of the Datalogic Memor™ depends on the application software loaded. However there are several parameters that can be set and utilities that can be used to perform some basic functions such as data capture, communications, file management, etc.

3.1 STARTUP

The Datalogic Memor™ turns on when the battery pack or the external supply is inserted.

After the battery pack is installed, use the [ON/OFF] key to turn the mobile computer on and off.

As soon as the mobile computer is on, the Windows CE 5.0 desktop configuration will appear on the screen. Wait a few seconds before starting any activity so that the mobile computer completes its startup procedure.



Use the stylus (par. 3.1.1) or joystick (par. 3.1.2) as suggested to select icons and options.

The mobile computer goes into power-off (low power with display and keyboard backlight off), when it is no longer used for more than a programmable timeout, which is defined in the POWER applet of the Control Panel. In this mode it can be awakened (resuming operation) by the [ON/OFF] key.

**NOTE**

The mobile computer can also be awakened or turned off by the application program.

3.1.1 Using the Stylus

The stylus selects items and enters information. The stylus functions like a mouse.

Tap:	Touch the screen once with the stylus to open items and select options.
Drag:	Hold the stylus on the screen and drag across the screen to select text and images. Drag in a list to select multiple items.
Tap-and-hold:	Tap and hold the stylus on an item to see a list of actions available for that item. On the pop-up menu that appears, tap the action you want to perform.

The stylus is factory aligned; however, it is possible to align the cursor on the screen with the tip of the stylus. Enter the STYLUS applet of the Control Panel and tap the center of each target that appears on the screen with the tip of the stylus.

3.1.2 Using the Joystick

The joystick selects items and enters information. The joystick can work like the directional arrow keys of a PC keyboard or can function like a mouse and control the mouse pointer. It's possible to switch between the two functioning modes by pressing blue modifier + BKSP keys simultaneously.

Arrow Keys Mode (default):	Move in the four directions: move forwards, backwards, upwards or downwards within text fields, scroll through a Menu list or browse among folder files. Press down: selects the current function (like the Enter key).
Mouse Mode:	Move in the four directions: move the mouse pointer forwards, backwards, upwards or downwards. Press down: like the left click of the mouse.

3.2 DATA CAPTURE

To configure and enable data capture parameters refer to par. 3.5.

3.2.1 Laser Data Capture

To scan barcodes, point the Datalogic Memor™ laser model onto the code from a distance within the reading range while pressing the SCAN key.

The lighted band emitted by the laser must completely intercept the barcode as shown in the figure below. If enabled, the emission of an acoustic signal will indicate that the scan has taken place correctly.

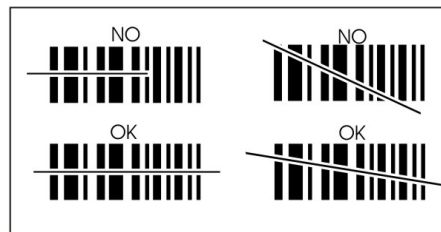
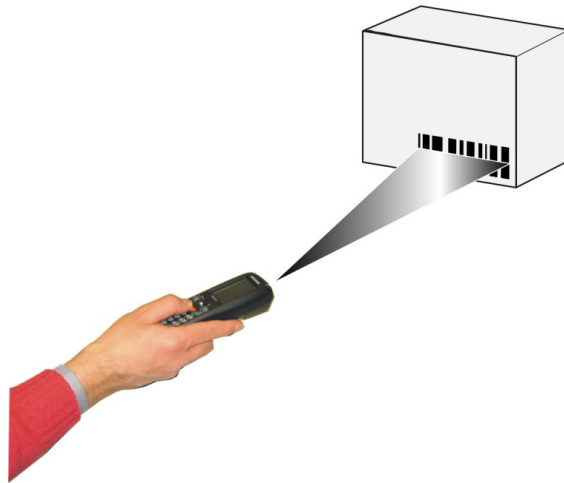







3.3 DESCRIPTION OF THE KEYS

The Datalogic Memor™ provides a 20-key alphanumeric keyboard + ON/OFF key + joystick. The following image shows this keyboard.







Main Keys Function

KEY	FUNCTION
	It starts barcode data capture.
	<p>The joystick lets you move forwards, backwards, upwards or downwards, scroll through a Menu list, browse among folder files or select functions if pressed down.</p> <p>It can work in two functioning modes: Arrow Keys Mode and Mouse Mode. It's possible to switch between them by pressing blue modifier + BKSP keys simultaneously (See par. 3.1.2).</p>
	Yellow modifier: when pressed before a standard key, it enables the character or function printed in yellow above the key.
	Blue modifier: when pressed before a standard key, it enables the character or function printed in blue above the key.
	It powers the Datalogic Memor™ ON or OFF. It is placed on the upper left side of the terminal.
	The ALPHA key is used to alternate numeric and alphanumeric use of the 10 numeric keys.

Keyboard Photosensing System

A photosensing system automatically controls the keyboard backlight according to the light intensity of the environment, reducing power consumption when not needed.

Special Function Icons

ICON	FUNCTION
	After a yellow modifier key press, it opens the Start menu.
	After a yellow modifier key press, it opens the file manager.
	After a yellow modifier key press, it switches ON/OFF the display backlight.
	After a blue modifier key press, it switches ON/OFF the keyboard backlight.
	After a blue modifier key press, it locks and unlocks the keyboard.

Hardware and Software Reset

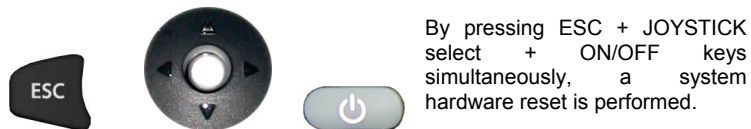

CAUTION

Before performing a hardware or software reset, it is recommended to:

- *execute a system backup to keep persistent your more important files and applications. See par. 3.8;*
- *save the registry to non-volatile memory to guarantee the persistence of the Windows configuration. See par. 3.6.2.*

3.4 STATUS INDICATORS

3.4.1 LED Status









The Datalogic Memor™ provides three different LEDs signaling the mobile computer status.

LED	STATUS	
Good Read and General Purpose (left side)	Green	It is constant for a configurable time to signal that a successful read has occurred.
	Green/Red	It is also available to the application program.
Charging Status (right side)	Green constant	It is constant once the charging process has been completed.
	Red constant	It is constant while charging.
Radio Status (on the upper left side of the joystick)	Blue	It blinks once Radio (802.11 b/g or Bluetooth) status is active.

3.4.2 Status Bar

The Status Bar provides information about the time, the battery level, the keyboard function, and the decoding status.



ICONS	DESCRIPTION
Time and Battery Icons	
10.50	It displays the time.
	They are representative of five different icons indicating the battery level. The icon is partially green when the power left is >20% and partially red colored when the power left is <20%.
	It indicates that the battery is charging.
Keyboard Status Icons	
The green segment over any of the following icons is lit when the Capslock is active.	
	It indicates that the blue FUNC key has been pressed and is going to affect the next key press.
	It indicates that the yellow FUNC key has been pressed and is going to affect the next key press.
	It indicates that the ALPHA key has enabled the selection of the characters printed in orange.
	It indicates the NUMERIC key selection, the ALPHA key has not been pressed.
	It indicates that the ALPHA key has enabled the selection of the characters printed in orange and the Capslock is active.
	It indicates that the keyboard is locked.
Decoding Status Icons	
	It indicates that the decoder is active (green), not active (grey).

3.5 DATA CAPTURE CONFIGURATION

From the Taskbar, tap the "Data Capture" icon to open a drop-down menu. Data Capture can also be accessed from the Control Panel.



By selecting the *Info* item from this drop-down menu you can access information about the Scanner and the Software; the *Configure* item opens the configuration applet (Data Capture Configuration Window), while *Capture* accesses the data capture applet (Data Capture Window), which enables code reading. The last menu item (*Wedge*) enables Wedge Emulation.

3.5.1 Configure

The Configuration applet contains the barcode scanning configuration parameters in a directory tree structure. The available barcode parameters are divided into two groups: Reader Parameters and Scan Parameters.

The Reader Parameters depend on the type of scanner module installed on the mobile computer and allow barcode configuration (i.e. enable/disable Code 39, check digit control, etc.).

The Scan Parameters are common to all scanner modules and allow control of the scanning device (i.e. beeper control, LED control, laser timeout, etc.).

Each Data Capture screen window corresponds to a branch of the tree, and the name of the current branch is displayed at the bottom of each screen window.

Reader Parameters

The barcode reading parameters and values are dependent upon the type of scanner module mounted in your mobile computer. For a detailed list of parameters and of their configuration procedures, please refer to the SDK Help file on the CD.

Scan Parameters

The Scan Parameters are common to all scanner modules and allow control of the scanning device. The Scan parameters are described as follows:

ScanTimeout: the maximum time, in milliseconds, during which the scanner remains on without decoding any barcode.

BeepType: if set to dual tone, the good read beep is a sequence of high and low pitch sounds. If set to monotone, the beep is a single pitch sound.

BeepDuration: the time interval, in milliseconds, during which the beeper will sound when the scanner reads a code. To disable the beeper, set this value to 0.

BeepFrequency: determines the frequency in Hertz of the beeper.

GoodReadSound: is the beep sound emitted when the scanner reads a code.

LedDuration: the length of the good-read led pulse, in milliseconds.

LedPulses: the number of times the good-read led pulse is emitted when the scanner reads a code.

ContinuousMode: disables the effect of the ScanTimeout parameter.

KeyboardEmulation: if enabled all scanned data are transformed into keyboard events and can therefore be displayed and saved to a file as if input from the mobile computer keyboard.

SoftTrigger: when enabled, the laser can be turned on/off by the application software.

ScanAlwaysOn: enables the scanner for barcode reading independently from the application software.

NotPrintableChar: if set to "Remove", all not printable characters included in the scanned data are deleted and the final barcode will include only printable characters.

Default Settings

The following tables contain the default values for the major barcode setup parameters, according to the type of scan engine mounted on the mobile computer. For a complete list of parameters and of their configuration procedures, please refer to the SDK Help file on the CD.

SCAN PARAMETERS	Laser Models
ScanTimeout	5000
BeepType	Dual tone
BeepDuration	20
BeepFrequency	2000
GoodReadSound	Beep
LedDuration	200 ms
LedPulses	1
ContinuousMode	Disabled
KeyboardEmulation	Disabled
SoftTrigger	Enabled
ScanAlwaysOn	Disabled
NotPrintableChar	Leave

BARCODE SYMBOLOGY SPECIFIC READER PARAMETERS	Laser Models
UPC A	Enabled
UPC E	Enabled
EAN 8	Enabled
EAN 13	Enabled
Code 39	Enabled
Code 39 Full ASCII	Disabled
Code 32	Disabled
2/5: Interleaved	Enabled
2/5: Industrial	Disabled
2/5: Matrix	Disabled
Code 128	Enabled
EAN 128	Enabled
Codabar	Disabled
MSI	Disabled
Plessey	Disabled
Code 93	Disabled
Code 11	Disabled

3.5.2 Capture

The Data Capture applet (Capture) enables code reading.

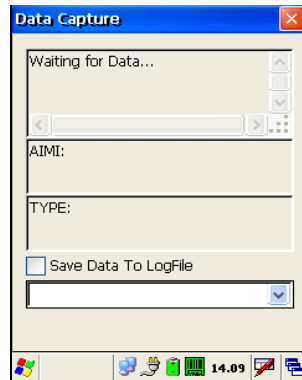

Data Capture Window

Data Capture can also be enabled through the Configuration applet by selecting File ->Scanner from the main menu, or by enabling the parameter Scan Always On in the Scan Parameters branch.

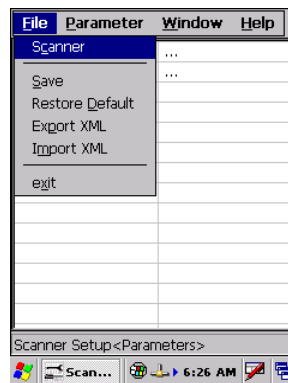

Enabling the Data Capture

3.6 CONTROL PANEL

From the Desktop, double tap on the "Control Panel" icon to open the Windows CE 5.0 control panel main window. The Control Panel can also be launched from Start ->Settings ->Control Panel.

APPLET programs are displayed as icons; one icon corresponds to each APPLETT.

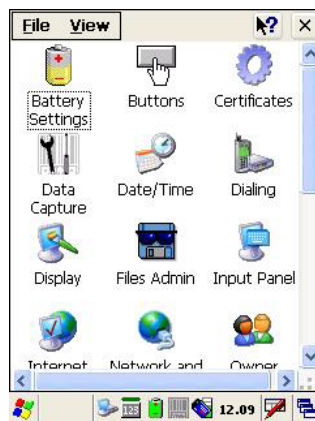

Control Panel

3.6.1 Buttons

The BUTTONS Applet allows assigning desired applications to be launched by one of the function keys (F1...F10).



3.6.2 Registry

The REGISTRY ADMIN applet provides management of Windows CE 5.0 registry.

Select the REGISTRY ADMIN applet by double tapping the Registry Admin icon.

The Registry Administration Main window appears. Two functions are available:

- Save Registry allows permanently saving the Windows configuration (example: custom configuration of screen desktop background color, or network adapter configuration) to non-volatile memory (SAVE button).
- Restore Default Registry allows restoring the initial factory default configuration (Restore Default button). After restoring the factory default configuration, you must perform a software reset.

Saving the registry to non-volatile memory guarantees the persistence of the Windows configuration in case of battery pack replacement.

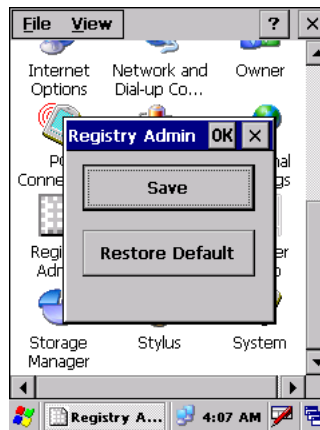

Registry Administration Window

3.6.3 Files Admin

The FILES ADMIN applet enables control of the permanence of files in the System Folder. Two functions are available on the Files Admin Main window by means of two buttons:

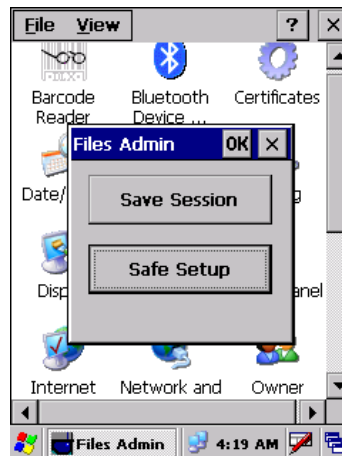

Files Admin Main Window

Save Session: with this button all files will be permanently saved in the Windows directory in non-volatile memory. This function guarantees the steady maintenance of every file produced during the current working session - even of sub-directories and relevant files - with the exception of the files belonging to the FLASH image.

These current working session files will be backed-up in the \Backup\Windows directory.

At the next hardware reset, the files previously saved in the \Backup\Windows directory will be restored to the Windows directory (see par. 3.8).

Safe Setup: with this button, the installation of software programs will be saved to non-volatile memory (Backup directory). Before doing this, it will be checked that the Backup directory has enough space to save the files. If the directory space is not enough, an error message will be shown and the program will exit the Safe Setup function.

Two activating procedures are available for Safe Setup:

- Select an installation file (for example, a .CAB cabinet file) from the Safe Setup mask.

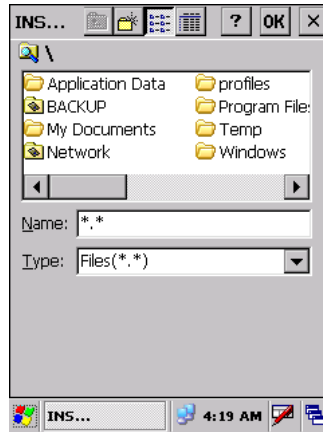

Safe Setup First Mask

Then select Windows or a relevant sub-directory in the path box. Then, Safe Setup will recognize the new files and directories present in the Windows directory, and will copy them to the \Backup\Windows directory. At the next hardware reset, these files will be restored (see par. 3.8).

- Simply skip the first mask either by closing it or by pressing the ESC key. When it closes, a new mask will pop up: it will enable any type of installation (even remote ones like ActiveSync® installations). Make sure the installation directory is Windows or one of its sub-directories. After installation, tap OK: Safe Setup will save the new files in the \Backup\Windows directory.

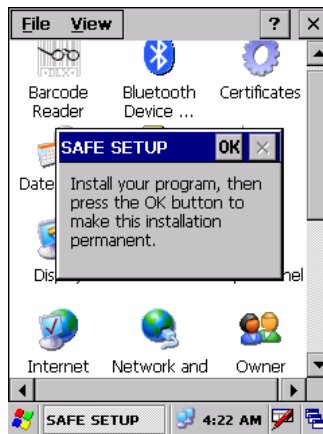

Safe Setup Second Mask

3.6.4 Wireless Communications

The WIRELESS COMMUNICATIONS applet provides management of the 802.11 b/g radio and of the Bluetooth® module.



Select the WIRELESS COMMUNICATIONS applet by double tapping the Wireless Communications icon. The following window will appear:

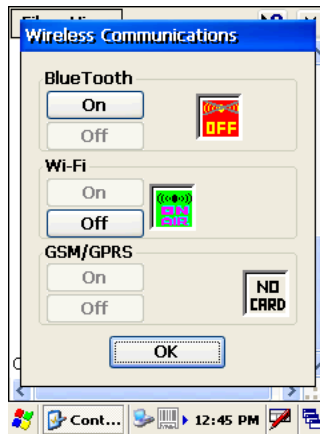

Wireless Communications Window



NOTE

In order to avoid wasting power, all modules are off by default.

3.7 WINDOWS CONNECTIONS

From the Desktop, double tap on the "Connections" folder to open the following window:

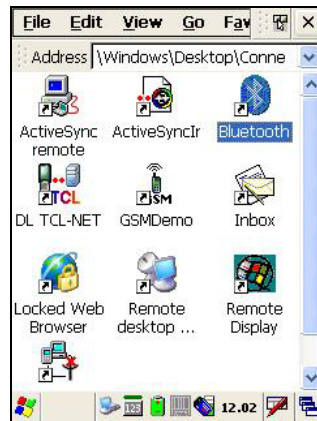

Windows Connections

3.7.1 Microsoft® ActiveSync®

Microsoft® ActiveSync® gives you the possibility to connect your desktop computer to your Datalogic Memor™ and synchronize the information on them. Synchronization compares the data on the Datalogic Memor™ with that on the desktop computer and updates both computers with the most recent information.

With ActiveSync®, it is possible to:

- Back up and restore Datalogic Memor™ data.
- Copy files between Datalogic Memor™ and desktop computer.
- Synchronize files by selecting a synchronization mode.

It is possible to constantly synchronize while connected to a desktop computer or, alternatively, synchronization can be performed only when the synchronize command is chosen. You can select which information types are synchronized and control how much data is synchronized.



NOTE

By default, ActiveSync® does not automatically synchronize all types of information. Use ActiveSync® options to turn synchronization on and off for specific information types.

For example:

Synchronize Microsoft Word and Microsoft Excel files between the Datalogic Memor™ and the desktop computer. The files will automatically be converted to the correct format.

You can establish a connection by Serial cable or by mini USB cable or by network. Moreover, if you have a Datalogic Memor™ Single Cradle you can connect your Datalogic Memor™ putting it into the cradle and using a standard mini USB cable or a standard Serial null modem cable.

**NOTE**

Visit the following Microsoft Web site for the latest in updates, technical information, and samples:

<http://www.microsoft.com/windowsmobile/resources/downloads>

ActiveSync® Remote

After a Partnership between mobile computer and desktop computer is established, it is also possible to establish a remote connection via Wireless LAN: disconnect the actual connection via ActiveSync® by double tapping the ActiveSync® connection icon on the taskbar and press Disconnect, then go to the \Windows\Desktop\Connection folder and double tap the ActiveSync® remote icon. In the dialog box that will appear it will be possible to choose a method to connect to the desktop computer. Choose Network Connection and press the Connect button:

**NOTE**

To set up your network connection you have to correctly set up your wireless connection. These settings depend on the wireless card that you have installed on your Datalogic Memor™ and on your wireless network settings. For more information about these settings contact your network administrator.

3.7.2 Bluetooth® Manager Device Setup

In order to enable a Bluetooth® device for communication with the Datalogic Memor™ you must perform the discovery procedure and enable the device as follows:

1. Place the Bluetooth® device within the range of the Datalogic Memor™ (10 meters).
2. From the “Connections” folder double tap on the “Bluetooth” applet to open the Bluetooth® Manager Device window:



3. Tap on the “Me” button to enter the related window; then, tap on the “ON” button to activate the Bluetooth® module. The module activation may be also performed by using the WIRELESS COMMUNICATION applet as described in par. 3.6.4.

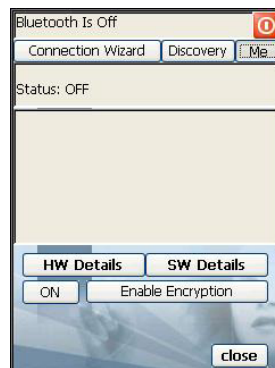

By tapping on the “HW Details” and “SW Details” buttons, information about the mobile computer Bluetooth® hardware and software will be displayed, while the “Enable Encryption” button starts encryption of the Bluetooth® communication data. If tapping on the “Close” button the Bluetooth® Manager Device window will be closed.

4. Tap on the "Discovery" button to enter the related window; then, tap on the "Scan" button to run the Discovery procedure:



Once the Discovery procedure has been completed, select the desired Bluetooth® device from the list. It is also possible to digit (12 hexadecimal digits) the Bluetooth® address of the desired device by tapping on the "Add" button. The "Clear" button deletes all discovered devices from the list.

5. Once the desired Bluetooth® device has been selected, tap on the "Connection Wizard" button to enter the related window where selecting the connection type to be used for communication with the Bluetooth® device:



The "Serial Port" button starts communication through the Bluetooth® serial port COM 5 (typically used for connection with GPS devices).
The "Printer" button starts communication with a printer through the Bluetooth® serial port COM 5.

The "Kbd Emulation" button allows connection with a barcode reader using the keyboard emulation.

The "ActiveSync" button starts communication with a PC equipped with a Bluetooth® antenna and the related ActiveSync.

6. Hide the Bluetooth® Manager Device window by tapping on the  icon available on each window or close it through the "Close" button available in the "Me" window (see step 3 of this procedure).

3.8 BACKUP DIRECTORY FILE MANAGEMENT

All of the Windows CE 5.0 system files reside in RAM (volatile memory) except for the Backup directory, which resides in FLASH (non-volatile memory). Therefore the contents of the Backup directory are persistent even if the mobile computer is re-booted or the battery pack is changed.

You can save your more important files that you don't want to lose due to mobile computer re-boot, in the Backup directory or create a sub-directory within Backup.

Even though the Windows Directory resides in RAM, it often contains files or sub-directories created by the user or by installation programs that you don't want to lose at re-boot. To keep these files persistent it is necessary to copy them to the directory \Backup\Windows. This directory doesn't exist originally (only Backup exists), and therefore it must be created. At the next hardware reset, before activating the shell, Windows CE 5.0 will copy the contents including all sub-directories of \Backup\Windows to \Windows.

Likewise, to maintain files that must be run at Windows CE 5.0 startup, (i.e. .exe, .lnk, .vb, .htm, etc.), it is necessary to copy them to the directory \Backup\Startup. This directory does not exist originally (only Backup exists), and therefore it must be created. The application programs will be run after any type of re-boot (both software and hardware reset).

As an alternative to the Safe Setup function, it is possible to copy the .cab files to the directory \Backup\Cabfiles (the Cabfiles sub-directory doesn't exist originally and must therefore be created) and perform a mobile computer cold boot to have the application installed. Once these files are copied to the directory \Backup\Cabfiles, the application will be run after each re-boot.

From the second cold boot on, a message may be displayed such as "<application name> is already installed. Re-install?". This message blocks the boot process. Press the [Enter] key to continue the system initialization.

4 MAINTENANCE



NOTE

Rechargeable backup batteries and battery packs are not initially charged. Therefore the initial operation to perform is to charge them. See below.



CAUTION

By default, the backup battery is disconnected at the factory to avoid damage due to excessive draining. If it is not connected (through the backup battery switch) and subsequently charged together with the battery pack, all data will be lost when changing the battery pack.

4.1 CONNECTING THE BACKUP BATTERY

The backup battery must be connected by putting the switch in the "connected" position. It will be charged together with the battery pack through the normal charging process.

It is only necessary to disconnect the backup battery if it will not be used for a long period of time (i.e. several weeks).



4.2 CHARGING THE BATTERY PACK

The battery pack autonomy varies according to factors, such as the frequency of barcode scanning, RF usage, etc.

The battery icon on the Status Bar indicates when the battery pack is low.

It is possible to recharge the battery pack by connecting the power supply directly to the Datalogic Memor™.

Alternatively, it is also possible to recharge the battery pack by using the Datalogic Memor™ Single Cradle.

Moreover recharging is possible by USB Direct connection with the host computer, but with longer charging times and in this case it is advised to keep the mobile computer off.

During the charging process the LED positioned at the right side of the display is red constant. Once the charging process has been completed this LED is green constant (see par. 3.4).

If the battery pack is removed from the mobile computer, it can be recharged by inserting it into the rear slot of the Datalogic Memor™ Single Cradle.



CAUTION

If the battery pack is new or has not been recharged for a long time, it is necessary to perform two or three charging and discharging cycles (complete use) before it can reach its maximum charge capability.

The maximum time required to recharge a completely run-down battery pack is about 3 hours if the mobile computer is idling.

4.3 REPLACING THE BATTERY PACK

To correctly replace the battery pack, proceed as follows.

1. Turn off the Datalogic Memor™.
2. Use the back of the stylus to rotate the battery cover screw to the vertical position, then push the battery clips in, as indicated in the figure below. The battery pack cover is now released.



3. Remove the cover and then the battery pack.



Battery Contacts



4. Install the new battery pack, first insert the bottom (contacts) side, then the upper (lock) side as indicated in the following figure:



5. For correct locking, push the battery clips outwards and rotate the screw to the horizontal position.

**WARNING**

Do not incinerate, disassemble, short terminals or expose to high temperature. Risk of fire, explosion. Use specified charger only. Risk of explosion if the battery is replaced by an incorrect type. Dispose of the batteries as required by the relevant laws in force.

**NOTE**

In order to guarantee an adequate operating autonomy, when replacing the battery pack the mobile computer checks the battery energy level. If the battery is not sufficiently charged, Datalogic Memor™ does not turn on (when pressing the ON/OFF key).

In this case, either substitute the battery pack with a charged one (sufficiently charged) or insert Datalogic Memor™ into a powered cradle or plug it into the direct power supply.

4.4 CLEANING THE MOBILE COMPUTER

Periodically clean the Datalogic Memor™ with a slightly dampened cloth.

Do not use alcohol, corrosive products or solvents.

5 TECHNICAL FEATURES

5.1 TECHNICAL DATA

Datalogic Memor™ Common Features

Electrical Features	
Power	
DC Supply	5 V ± 5%
Battery Pack	1 cell Li-Ion 1000 mAh@3.7 V (nominal) Alternatively 1 cell Li-Ion 2000 mAh
Internal Backup Battery	Rechargeable Ni-MH 30 mAh (2 x 15 mAh cells)
Communication Features	
Bluetooth Interface	COM5
Serial Interface	RS232 USB 1.1
	COM1 COM6
Windows CE COM Port	
Wireless Features	
WLAN	IEEE 802.11b/g DSSS
WPAN	Bluetooth® IEEE 802.15, Class 2, Version 1.2
Environmental Features	
Working Temperature	0° to +50 °C / 32 °F to +122 °F
Storage Temperature	-10° to +65 °C / -14 °F to +149 °F
Humidity	10 to 80% non condensing for temperatures < 40 °C
Protection	IP 54
ESD Protection	4 KV contact discharge, 8 KV air discharge
Drop Resistance	1.2 m / 3 ft. 11 in.
Hardware Features	
FLASH	128 MB
RAM	64 MB
Microprocessor	Intel PXA 255 200 MHz
Audio	Beeper
LEDs	Two-color Good Read/Programmable Charging Status Radio Status
Display	Transflective 64K Color TFT LCD with 320 x 240 pixel resolution (QVGA), with LED backlight and touch screen, antiglare and antiscratch protection
Keyboard	20 Plastic Top - Backlit Keys + Joystick + lateral ON/OFF key
Mechanical Features	
Dimensions (LxWxH)	15.2 x 5.5 x 4.0 cm / 5.9 x 2.1 x 1.5 in
Weight (depending on model)	210 g / 7.42 oz (incl. 1000 mAH battery) 240 g / 8.48 oz (incl. 2000 mAH battery)

Programming Features	
Operating system	Windows CE 5.0
Laser Models	
Decoded barcodes 1D	UPC A, UPC E, EAN 8, EAN 13, Code 39, Code 39 Full ASCII, Code 32, Interleaved 2 of 5, Industrial 2 of 5, Matrix 2 of 5, Code 128, EAN 128, Codabar, MSI, Plessey, Code 93, Code 11

Datalogic Memor™ Laser Optical Features

Laser Optical Features	
	Datalogic Memor™ XXX 9XX XXX Models
Maximum resolution	0.10 mm / 4 mils
Skew angle	± 50°
Pitch angle	± 65°
Scan rate - bidirectional	104 ± 12 scan/sec
Light source laser scanner	VLD, wavelength 630~680 nm
Safety class	Class II EN 60825-1/CDRH

Datalogic Memor™ CCD Optical Features

Laser Optical Features	
	Datalogic Memor™ XXX 8XX XXX Models
Maximum resolution	0.13 mm / 5 mils
Skew angle	± 60°
Pitch angle	± 60°
Scan rate	100 scan/sec
Sensor	Linear CMOS array
Illuminator	LED array
Wavelength	624 nm
LED Safety class	Class 1 LED Product

6 TEST CODES

High Density Codes

0.25 mm (10 mils)

Code 39



17162

2/5 Interleaved



0123456784

Code 128



test

EAN 13



8 012345 000012

EAN 8



6450 9723

Medium Density Codes0.38 mm (15 mils)

Code 39



17162

Interleaved 2/5



0123456784

Code 128



test

EAN 13



EAN 8

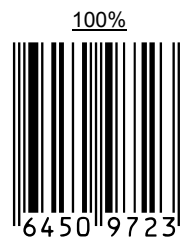

Low Density Codes

0.50 mm (20 mils)

Code 39



17162

Interleaved 2/5

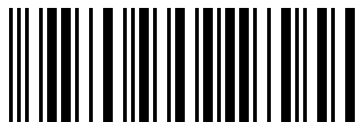

0123456784

Code 128



test



120%

EAN 13



8 012345 000012

120%

EAN 8



6450 9723



GLOSSARY

Access Point

A device that provides transparent access between Ethernet wired networks and IEEE 802.11 interoperable radio-equipped mobile units. Hand-held mobile computers, PDAs or other devices equipped with radio cards, communicate with wired networks using Access Points (AP). The mobile unit (mobile computer) may roam among the APs in the same subnet while maintaining a continuous, seamless connection to the wired network.

Barcode

A pattern of variable-width bars and spaces which represents numeric or alphanumeric data in binary form. The general format of a barcode symbol consists of a leading margin, start character, data or message character, check character (if any), stop character, and trailing margin. Within this framework, each recognizable symbology uses its own unique format.

Baud Rate

A measure for data transmission speed.

Bit

Binary digit. One bit is the basic unit of binary information. Generally, eight consecutive bits compose one byte of data. The pattern of 0 and 1 values within the byte determines its meaning.

Bluetooth®

A standard radio technology using a proprietary protocol. The onboard Bluetooth module in the mobile computer is compatible with the 1.1 protocol.

Byte

On an addressable boundary, eight adjacent binary digits (0 and 1) combined in a pattern to represent a specific character or numeric value. Bits are numbered from the right, 0 through 7, with bit 0 the low-order bit. One byte in memory can be used to store one ASCII character.

Decode

To recognize a bar code symbology (e.g., Codabar, Code 128, Code 3 of 9, UPC/EAN, etc.) and analyze the content of the bar code scanned.

EEPROM

Electrically Erasable Programmable Read-Only Memory. An on-board non-volatile memory chip.

Flash Disk

Non-volatile memory for storing application and configuration files.

Host

A computer that serves other mobile computers in a network, providing services such as network control, database access, special programs, supervisory programs, or programming languages.

Liquid Crystal Display (LCD)

A display that uses liquid crystal sealed between two glass plates. The crystals are excited by precise electrical charges, causing them to reflect light outside according to their bias. They use little electricity and react relatively quickly. They require external light to reflect their information to the user.

Light Emitting Diode (LED)

A low power electronic light source commonly used as an indicator light. It uses less power than an incandescent light bulb but more than a Liquid Crystal Display (LCD).

RAM

Random Access Memory. Data in RAM can be accessed in random order, and quickly written and read.

RF

Radio Frequency.

RTC

Real Time Clock.

INDEX

- A**
Accessories, 4
- B**
Backup Directory File Management, 32
Bluetooth® Manager Device Setup, 30
Buttons, 23
- C**
Charging the Batteries, 34
Cleaning the Mobile Computer, 36
Connecting the Backup Battery, 33
Connection Cables, 9
 RS232 Direct Connection, 9
Connections, 5
 RS232 Connection, 6
 USB Connection, 5
 WLAN Connection, 7
 WPAN Connections, 8
Control Panel, 23
Conventions, vii
- D**
Data Capture, 12
 Laser Data Capture, 12
Data Capture Configuration, 18
Datalogic Memor™ Description, 1
Default Settings, 21
Description of the Keys, 13
- E**
End User License Agreement, v
- F**
Files Admin, 25
- G**
General View, xiv
Glossary, 42
- L**
Laser Safety, ix
LED Illuminator, xii
- M**
Maintenance, 33
Microsoft® ActiveSync®, 28
Model Description, 2
- P**
Package Contents, 2
- R**
Radio Compliance, xii
Reader Parameters, 20
Reference Documentation, vii
References, vii
Registry, 24
Replacing the Batteries, 35
- S**
Safe Setup, 25
Safety Regulations, viii
Save Session, 25
Scan Parameters, 20
Services and Support, vii
Startup, 10
Status Indicators, 16
- T**
Technical Features, 37
Test Codes, 39
- U**
Using the Joystick, 11
Using the Stylus, 11
- W**
WEEE Compliance, xiii
Wireless Communications, 27