

Datalogic Jet™

USER'S MANUAL



DATALOGIC

DATALOGIC S.p.A.
Via Candini 2
40012 - Lippo di Calderara di Reno
Bologna - Italy

Datalogic Jet™ - User's Manual

Ed.: 09/2006

ALL RIGHTS RESERVED

Datalogic reserves the right to make modifications and improvements without prior notification.

Datalogic shall not be liable for technical or editorial errors or omissions contained herein, nor for incidental or consequential damages resulting from the use of this material.

Product names mentioned herein are for identification purposes only and may be trademarks and or registered trademarks of their respective companies.

© Datalogic S.p.A. 2004-2006

CONTENTS

	DATALOGIC END USER LICENSE AGREEMENT	v
	REFERENCES	vii
	Conventions	vii
	Reference Documentation	vii
	Services and Support	vii
	SAFETY REGULATIONS	viii
	General Safety Rules	viii
	Bluetooth® Approval	viii
	Laser Safety	ix
	Radio Compliance	xiii
	FCC Compliance	xiv
	SAR Compliance	xiv
	WEEE Compliance	xiv
	GENERAL VIEW	xv
1	INTRODUCTION	1
1.1	Datalogic Jet™ PDA Description	1
1.2	Available Models	2
1.3	Package Contents	2
1.4	Inserting Mini SD Card	3
1.5	Accessories	4
2	CONNECTIONS	5
2.1	PDA Connection to the Host Computer	5
2.1.1	RS232/USB Direct Connection	5
2.1.2	WLAN Connection	6
2.1.3	WPAN Connection	7
2.1.4	WWAN Connection	8
2.2	Connection Cables	11
3	USE AND FUNCTIONING	12
3.1	PDA Startup	12
3.2	Using the Stylus	13
3.3	Data Capture	14
3.3.1	Laser Data Capture	14
3.3.2	Imager Data Capture	15
3.3.3	RFID Data Capture	16
3.4	Description of the Keys	17
3.4.1	System Control and Navigation Keys	17

3.4.2	Key Selection	18
3.5	Status Indicators	20
3.5.1	LED Status	20
3.5.2	Status Bar	21
3.6	Data Capture Configuration	22
3.6.1	Configure	22
3.6.2	Capture	26
3.7	Control Panel	27
3.7.1	Buttons.....	28
3.7.2	Registry.....	28
3.7.3	Files Admin	29
3.7.4	Wireless Communications.....	31
3.7.5	Volume Settings.....	32
3.8	Windows Connections	35
3.8.1	Microsoft® ActiveSync®	35
3.8.2	Bluetooth® Manager Device Setup.....	37
3.9	Backup Directory File Management.....	40
4	MAINTENANCE	41
4.1	Charging the Battery Pack	41
4.2	Replacing the Battery Pack.....	42
4.3	Cleaning the PDA	43
5	TECHNICAL FEATURES.....	44
5.1	Technical Data	44
5.2	Reading Diagrams	47
6	TEST CODES	48
	GLOSSARY.....	51
	INDEX.....	54

DATALOGIC END USER LICENSE AGREEMENT

BY DOWNLOADING OR INSTALLING THE SOFTWARE, OR BY USING DATALOGIC EQUIPMENT THAT INCLUDES THIS SOFTWARE, YOU ARE CONSENTING TO BE BOUND BY THIS AGREEMENT. IF YOU DO NOT AGREE TO ALL OF THE TERMS OF THIS AGREEMENT, THEN DO NOT DOWNLOAD, INSTALL, USE THE SOFTWARE NOR DATALOGIC EQUIPMENT.

The following terms and conditions govern your use of the Software except to the extent that a particular program (a) is the subject of a separate written agreement with Datalogic or (b) includes a separate "click-on" license agreement as part of the installation and/or download process. Should a conflict arise between the provisions of the foregoing documents, the order of precedence shall be (1) the written agreement, (2) the click-on agreement, and (3) this agreement ("Agreement").

1. License. Subject to the terms and conditions of and except as otherwise provided in this Agreement, Datalogic S.p.A. ("Datalogic") and its suppliers grant to Customer ("Customer") a nonexclusive and nontransferable license to use the specific program modules, feature set(s) or feature(s) in object code form only as well as associated media, printed materials and "online" or electronic documentation (the "Software") for which Customer has paid, if required, the license fees. The Software is licensed not sold. The license shall be subject to each of the following limitations:

- Unless otherwise expressly provided in the documentation, Customer shall use the Software solely as embedded in, for execution on, or (where the applicable documentation permits installation on non-Datalogic equipment) for communication with Datalogic equipment owned or leased by Customer;
- Customer's use of the Software shall be limited to use on a single hardware chassis, on a single central processing unit, as applicable, or use on such greater number of chassis or central processing units as Customer may have paid Datalogic the required license fee; and
- Customer's use of the Software shall also be limited, as applicable and set forth in Customer's purchase order or in Datalogic's product catalog, user documentation, or web site, to a maximum number of (a) seats (i.e. users with access to the installed Software), (b) concurrent users, sessions, ports, and/or issued and outstanding IP addresses, and/or (c) central processing unit cycles or instructions per second. Customer's use of the Software shall also be limited by any other restrictions set forth in Customer's purchase order or in Datalogic's product catalog, user documentation or web site of the Software.

2. General Limitations. Except as otherwise expressly provided under this Agreement, Customer shall have no right, and Customer specifically agrees not to (i) transfer, assign or sublicense its license rights to any other person, or use the Software on unauthorized or secondhand Datalogic equipment, and any such attempted transfer, assignment or sublicense shall be void; (ii) correct errors to or otherwise modify or adapt the Software or create derivative works based upon the Software, or to permit third parties to do the same; or (iii) decompile, decrypt, reverse engineer, disassemble or otherwise reduce the Software to human-readable form to gain access to trade secrets or confidential information in the Software. To the extent required by law, at Customer's request, Datalogic shall provide Customer with the interface information needed to achieve interoperability between the Software and another independently created program, upon payment of Datalogic's applicable fee. Customer shall observe strict obligations of confidentiality with respect to such information.

3. Upgrades and Additional Copies. For purposes of this Agreement, "Software" shall include (and the terms and conditions of this Agreement shall apply to) any upgrades, updates, bug fixes or modified versions (collectively, "Upgrades") or backup copies of the Software licensed or provided to Customer by Datalogic or an authorized distributor for which Customer has paid the applicable license fees. Notwithstanding any other provision of this Agreement: (1) customer has no license or right to use any such additional copies or upgrades unless customer, at the time of acquiring such copy or upgrade, already holds a valid license to the original Software and has paid the applicable fee for the upgrade, if required; (2) use of upgrades is limited to Datalogic equipment for which customer is the original end user, purchaser or lessee or who otherwise holds a valid license to use the Software which is being upgraded; and (3) use of additional copies is limited to backup purposes only.

4. Proprietary Notices. Customer agrees to maintain and reproduce all copyright and other proprietary notices on all copies, in any form, of the Software in the same form and manner that such copyright and other proprietary notices are included on the Software. Except as expressly authorized in this Agreement, Customer shall not make any copies or duplicates or any Software without the prior written permission of Datalogic. Customer may make such backup copies of the Software as may be necessary for Customer's lawful use, provided Customer affixes to such copies all copyright, confidentiality, and proprietary notices that appear on the original.

5. Protection of Information. Customer agrees that aspects of the Software and associated documentation, including the specific design and structure of individual programs, constitute trade secrets and/or copyrighted material of Datalogic. Customer shall not disclose, provide, or otherwise make available such trade secrets or copyrighted material in any form to any third party without the prior written consent of Datalogic. Customer shall implement reasonable security measures to protect such trade secrets and copyrighted material. Software and documentation shall remain solely property of Datalogic.

6. Limited Warranty. If Customer obtained the Software directly from Datalogic, then Datalogic warrants that during the Warranty Period (as defined below): (i) the media on which the Software is furnished will be free of defects in materials and workmanship under normal use; and (ii) the Software will substantially conform to its published specifications. The "Warranty Period" means a period beginning on the date of Customer's receipt of the Software and ending on the later of (a) ninety (90) days from the date of initial shipment of the Software by Datalogic, or (b) the end of the minimum period required by the law of the applicable jurisdiction. The limited warranties extend only to Customer as the original licensee. Customer's sole and exclusive remedy and the entire liability of Datalogic and its suppliers under these limited warranties will be, at Datalogic's sole option, repair or replacement of the Software if reported (or, upon request, returned) to Datalogic. Except as expressly granted in this Agreement, the Software is provided **AS IS** and with all faults. Datalogic does not warrant that the Software is error free or that Customer will be able to operate the Software without problems or interruptions. In addition, due to the continual development of new techniques for intruding upon and attacking networks, Datalogic does not warrant that the Software or any equipment, system or network on which the Software is used will be free of vulnerability to intrusion or attack. This warranty does not apply if the Software (a) is licensed for beta, evaluation, testing or demonstration purposes for which Datalogic does not receive a license fee, (b) has been altered, except by Datalogic, (c) has not been installed, operated, repaired, or maintained in accordance with instructions supplied by Datalogic, (d) has been subjected to abnormal physical or electrical stress, misuse, negligence, or accident, or (e) is used in ultra hazardous activities. If Customer obtained the Software from a Datalogic reseller, the terms of any warranty shall be as provided by such distributor, and Datalogic provides Customer no warranty with respect to such Software. The Software may contain support for programs written in Java. Java technology is not fault tolerant and is not designed, manufactured, or intended for use or resale as online control equipment in hazardous environments requiring fail-safe performance, such as in the operation of nuclear facilities, aircraft navigation or communication systems, air traffic control, direct life support machines, or weapons systems, in which the failure of Java technology could lead directly to death, personal injury, or severe physical or environmental damage. Microsoft Inc. has contractually obligated Datalogic to make this disclaimer.

7. Disclaimer of Warranties. Except as specified in this warranty, all expressed or implied conditions, representations, and warranties including, without limitation, any implied warranty or condition of merchantability, fitness for a particular purpose, non-infringement, satisfactory quality or arising from a course of dealing, usage, or trade practice, are hereby excluded to the extent allowed by applicable law. To the extent that an implied warranty cannot be excluded, such warranty is limited in duration to the warranty period.

8. Disclaimer of Liabilities. In no event will Datalogic or its suppliers be liable for any lost revenue, profit, or data, or for special, indirect, consequential, incidental, or punitive damages however caused and arising out of the use of or inability to use the Software even if Datalogic has been advised of the possibility of such damages. In no event shall Datalogic or its suppliers' liability to customer, whether in contract, tort (including negligence), or otherwise, exceed the price paid by customer. The foregoing limitations shall apply even if the above-stated warranty fails of its essential purpose.

9. Term and Termination. This Agreement is effective until terminated. Customer may terminate this Agreement at any time by destroying all copies of Software including any documentation. Customer's license rights under this Agreement will terminate immediately without notice from Datalogic if Customer fails to comply with any provision of this Agreement. Upon termination, Customer must destroy all copies of Software in its possession or control.

10. Customer Records. Customer grants to Datalogic and its independent accountants the right to examine Customer's books, records and accounts during Customer's normal business hours to verify compliance with this Agreement. In the event such audit discloses non-compliance with this Agreement, Customer shall promptly pay to Datalogic the appropriate license fees.

11. General Provisions. This Agreement shall be governed by and construed in accordance with the laws of Italy. All disputes arising out of or in connection with this Agreement will be subject to the exclusive jurisdiction of the competent Court of the place where Datalogic has its registered office. If any portion hereof is found to be void or unenforceable, the remaining provisions of this Agreement shall remain in full force and effect. Except as expressly provided herein, this Agreement constitutes the entire agreement between the parties with respect to the license of the Software and supercedes any conflicting or additional terms contained in the purchase order.

DATALOGIC



REFERENCES

CONVENTIONS

This manual uses the following conventions:

“User” refers to anyone using a Datalogic Jet™ PDA.

“PDA” and “Datalogic Jet™” refer to Datalogic Jet™ PDA.

“You” refers to the System Administrator or Technical Support person using this manual to install, configure, operate, maintain or troubleshoot a Datalogic Jet™ PDA.

REFERENCE DOCUMENTATION

For further information regarding Datalogic Jet™ refer to the SDK Help on-Line.

SERVICES AND SUPPORT

Datalogic provides several services as well as technical support through its website. Log on to **www.datalogic.com** and click on the links indicated for further information including:

- **PRODUCTS**

Search through the links to arrive at your product page where you can download specific **Manuals** and **Software & Utilities**

- **SERVICES & SUPPORT**

- **Datalogic Services** Warranty Extensions and Maintenance Agreements
- **Authorised Repair Centres**

- **CONTACT US**

E-mail form and listing of Datalogic Subsidiaries

SAFETY REGULATIONS



NOTE

Read this manual carefully before performing any type of connection to the Datalogic Jet™ PDA.

The user is responsible for any damages caused by incorrect use of the equipment or by inobservance of the indication supplied in this manual.

GENERAL SAFETY RULES

- Use only the components supplied by the manufacturer for the specific Datalogic Jet™ PDA being used.
- Do not attempt to disassemble the Datalogic Jet™ PDA, as it does not contain parts that can be repaired by the user. Any tampering will invalidate the warranty.
- When replacing the battery pack or at the end of the operative life of the Datalogic Jet™ PDA, disposal must be performed in compliance with the laws in force. See also par. 4.2.
- Do not submerge the Datalogic Jet™ PDA in liquid products.

BLUETOOTH® APPROVAL

This product is equipped with the following certified Bluetooth module:

Product Name: Datalogic CE BLUETOOTH SUBSYSTEM

Bluetooth ID: B03071

Product ID: DLBTCE-02

LASER SAFETY

The laser light is visible to the human eye and is emitted from the window indicated in the figure.

This information applies to both Laser models and the Datalogic Jet™ Imager Aiming System.

Laser output window



AVOID EXPOSURE
LASER LIGHT
IS EMITTED FROM
THIS APERTURE

This product complies with
21 CFR Subchapter J

LASER LIGHT - DO NOT STARE INTO BEAM
CLASS 2 LASER PRODUCT
MAX. OUTPUT RADIATION 1.4 mW
EMITTED WAVELENGTH 630-680 nm
EN60825-1:2001

CAUTION-CLASS 2 LASER LIGHT WHEN OPEN - DO NOT STARE INTO BEAM

I	D	F	E
La luce laser è visibile all'occhio umano e viene emessa dalla finestra indicata nella figura.	Die Laserstrahlung ist für das menschliche Auge sichtbar und wird am Strahlaustrittsfenster ausgesendet (siehe Bild).	Le rayon laser est visible à l'œil nu et il est émis par la fenêtre désignée sur l'illustration dans la figure.	La luz láser es visible al ojo humano y es emitida por la ventana indicada en la figura.
LUCE LASER NON FISSARE IL FASCIO APPARECCHIO LASER DI CLASSE 2 MINIMA POTENZA DI USCITA: LUNGHEZZA D'ONDA EMESSA: CONFORME A EN 60825-1 (2001)	LASERSTRAHLUNG NICHT IN DER STRAHL BLINKEN PRODUKT DER LASERKLASSE 2 MAXIMALE AUSGANGLEISTUNG: WELLENLÄNGE: ENTSPR. EN 60825-1 (2001)	RAYON LASER EVITER DE REGARDER LE RAYON APPAREIL LASER DE CLASSE 2 PUISSANCE DE SORTIE: LONGUEUR D'ONDE EMISE: CONFORME A EN 60825-1 (2001)	RAYO LÁSER NO MIRAR FIJO EL RAYO APARATO LÁSER DE CLASE 2 MÁXIMA POTENCIA DE SALIDA: LONGITUD DE ONDA EMITIDA: CONFORME A EN 60825-1 (2001)

ENGLISH

The following information is provided to comply with the rules imposed by international authorities and refers to the correct use of your PDA.

STANDARD LASER SAFETY REGULATIONS

This product conforms to the applicable requirements of both CDRH 21 CFR 1040 and EN 60825-1 at the date of manufacture.

For installation, use and maintenance, it is not necessary to open the device.



WARNING

Use of controls or adjustments or performance of procedures other than those specified herein may result in exposure to hazardous visible laser light.

The product utilizes a low-power laser diode. Although staring directly at the laser beam momentarily causes no known biological damage, avoid staring at the beam as one would with any very strong light source, such as the sun. Avoid that the laser beam hits the eye of an observer, even through reflective surfaces such as mirrors, etc.

ITALIANO

Le seguenti informazioni vengono fornite dietro direttive delle autorità internazionali e si riferiscono all'uso corretto del PDA.

NORMATIVE STANDARD PER LA SICUREZZA LASER

Questo prodotto risulta conforme alle normative vigenti sulla sicurezza laser alla data di produzione: CDRH 21 CFR 1040 e EN 60825-1.

Non si rende mai necessario aprire l'apparecchio per motivi di installazione, utilizzo o manutenzione.



ATTENZIONE

L'utilizzo di procedure o regolazioni differenti da quelle descritte nella documentazione può provocare un'esposizione pericolosa a luce laser visibile.

Il prodotto utilizza un diodo laser a bassa potenza. Sebbene non siano noti danni riportati dall'occhio umano in seguito ad una esposizione di breve durata, evitare di fissare il raggio laser così come si eviterebbe qualsiasi altra sorgente di luminosità intensa, ad esempio il sole. Evitare inoltre di dirigere il raggio laser negli occhi di un osservatore, anche attraverso superfici riflettenti come gli specchi.

DEUTSCH

Die folgenden Informationen stimmen mit den Sicherheitshinweisen überein, die von internationalen Behörden auferlegt wurden, und sie beziehen sich auf den korrekten Gebrauch vom PDA.

NORM FÜR DIE LASERSICHERHEIT

Dies Produkt entspricht am Tag der Herstellung den gültigen EN 60825-1 und CDRH 21 CFR 1040 Normen für die Lasersicherheit.

Es ist nicht notwendig, das Gerät wegen Betrieb oder Installations-, und Wartungs-Arbeiten zu öffnen.



ACHTUNG

Jegliche Änderungen am Gerät sowie Vorgehensweisen, die nicht in dieser Betriebsanleitung beschrieben werden, können ein gefährliches Laserlicht verursachen.

Der Produkt benutzt eine Laserdiode. Obwohl zur Zeit keine Augenschäden von kurzen Einstrahlungen bekannt sind, sollten Sie es vermeiden für längere Zeit in den Laserstrahl zu schauen, genauso wenig wie in starke Lichtquellen (z.B. die Sonne). Vermeiden Sie es, den Laserstrahl weder gegen die Augen eines Beobachters, noch gegen reflektierende Oberflächen zu richten.

FRANÇAIS

Les informations suivantes sont fournies selon les règles fixées par les autorités internationales et se réfèrent à une correcte utilisation du PDA.

NORMES DE SECURITE LASER

Ce produit est conforme aux normes de sécurité laser en vigueur à sa date de fabrication: CDRH 21 CFR 1040 et EN 60825-1.

Il n'est pas nécessaire d'ouvrir l'appareil pour l'installation, l'utilisation ou l'entretien.



ATTENTION

L'utilisation de procédures ou réglages différents de ceux donnés ici peut entraîner une dangereuse exposition à lumière laser visible.

Le produit utilise une diode laser. Aucun dommage aux yeux humains n'a été constaté à la suite d'une exposition au rayon laser. Eviter de regarder fixement le rayon, comme toute autre source lumineuse intense telle que le soleil. Eviter aussi de diriger le rayon vers les yeux d'un observateur, même à travers des surfaces réfléchissantes (miroirs, par exemple).

ESPAÑOL

Las informaciones siguientes son presentadas en conformidad con las disposiciones de las autoridades internacionales y se refieren al uso correcto del PDA.

NORMATIVAS ESTÁNDAR PARA LA SEGURIDAD LÁSER

Este aparato resulta conforme a las normativas vigentes de seguridad láser a la fecha de producción: CDRH 21 CFR 1040 y EN 60825-1.

No es necesario abrir el aparato para la instalación, la utilización o la manutenzione.



ATENCIÓN

La utilización de procedimientos o regulaciones diferentes de aquellas descritas en la documentación puede causar una exposición peligrosa a la luz láser visible.

El aparato utiliza un diodo láser a baja potencia. No son notorios daños a los ojos humanos a consecuencia de una exposición de corta duración. Eviten de mirar fijo el rayo láser así como evitarían cualquiera otra fuente de luminosidad intensa, por ejemplo el sol. Además, eviten de dirigir el rayo láser hacia los ojos de un observador, también a través de superficies reflectantes como los espejos.

LED Illuminator

The use of an illuminator in the Datalogic Jet™ Imager is a Class 1 LED product:

CLASS 1 LED PRODUCT

ILLUMINATORE LED CLASSE 1

AUSLEUCHTER LED KLASSE 1

ILLUMINATEUR A LED DE CLASSE 1

ILUMINADOR LED DE CLASE 1

RADIO COMPLIANCE

In radio systems configured with PDAs and access points, the frequencies to be used must be allowed by the spectrum authorities of the specific country in which the installation takes place. Be absolutely sure that the system frequencies are correctly set to be compliant with the spectrum requirements of the country.

The Radio modules used in this product automatically adapt to the frequencies set by the system and do not require any parameter settings.

The following shows the correspondence between the Datalogic Jet™ models and the Radio modules:

- Datalogic Jet™ 5XX-XXX-XXX 802.11b (Wi-Fi) radio card
- Datalogic Jet™ X1X-XXX-XXX GSM/GPRS Tri-band (900, 1800, 1900 MHz) module
- Datalogic Jet™ 51X-XXX-XXX 802.11b (Wi-Fi) radio card + GSM/GPRS Tri-band (900, 1800, 1900 MHz) module

Information for the User

ENGLISH

Contact the competent authority responsible for the management of radio frequency devices of your country to verify the eventual necessity of a user license. Refer to the web site <http://europa.eu.int/comm/enterprise/rte/spectr.htm> for further information.

ITALIANO

Prendi contatto con l'autorità competente per la gestione degli apparati a radio frequenza del tuo paese, per verificarne l'eventuale necessità della licenza d'uso. Inoltre puoi trovare ulteriori informazioni al sito: <http://europa.eu.int/comm/enterprise/rte/spectr.htm>.

FRANÇAIS

Contactez l'autorité compétente en la gestion des appareils à radio fréquence de votre pays pour vérifier la nécessité du permis d'usage. Pour tout renseignement vous pouvez vous adresser au site web: <http://europa.eu.int/comm/enterprise/rte/spectr.htm>.

DEUTSCH

Um die Notwendigkeit der Verwendungslizenz zu prüfen, wenden Sie sich an die Behörde, die auf der Radiofrequenzgerätsführung Ihres Lands bewandert ist. Weitere Informationen sind verfügbar auf dem Web Site: <http://europa.eu.int/comm/enterprise/rte/spectr.htm>.

ESPAÑOL

Contacta con la autoridad competente para la gestión de los dispositivos de radio frecuencia de tu país, para verificar si es necesario la licencia de uso. Además se puede encontrar mas información en el sitio web:

<http://europa.eu.int/comm/enterprise/rte/spectr.htm>.



FCC COMPLIANCE

Modifications or changes to this equipment without the expressed written approval of Datalogic could void the authority to use the equipment.

This device complies with PART 15 of the FCC Rules. Operation is subject to the following two conditions: (1) This device may not cause harmful interference, and (2) this device must accept any interference received, including interference which may cause undesired operation.

FCC ID O MJ0019.

All Wi-Fi models contain FCC ID H9PLAH137.

All GSM models contain FCC ID QIPMC55.

SAR COMPLIANCE

This product has been tested and found to comply with the following standards:

- EN50360: product standard to demonstrate the compliance of mobile phones with the basic restrictions related to human exposure to electromagnetic fields (300 MHz – 3 GHz).
- EN50361: basic standard for the measurement of specific absorption rate related to human exposure to electromagnetic fields from mobile phones (300 MHz – 3 GHz).
- OET BULLETIN 65 SUPPLEMENT C: evaluating compliance with FCC guidelines for human exposure to radio frequency electromagnetic fields.
- Australian Radiation Protection And Nuclear Safety Agency (ARPANSA): radiation protection series publication No. 3: maximum exposure levels to radio frequency fields 3 KHz TO 300 GHz.

WEEE COMPLIANCE



GENERAL VIEW



Figure A – General View

- | | |
|-------------------------------------|-------------------------|
| A) Data capture/Laser output window | J) Backlit display |
| B) Scan key(s) (3) | K) Mini SD card SLOT |
| C) Bluetooth® LED | L) Microphone |
| D) Charging status LED | M) Latch release button |
| E) Backlit keyboard | N) Battery latch |
| F) External power supply connector | O) Battery pack |
| G) Communication/Charger connector | P) Speaker |
| H) Headset jack | Q) IrDA port |
| I) User programmable LED | |

1 INTRODUCTION

1.1 DATALOGIC JET™ PDA DESCRIPTION

The Datalogic JET™, is the powerful Datalogic PDA. Thanks to the state-of the-art architecture and the most advanced technologies, it can provide the most suitable levels for capturing, computing and communicating data faster and easier.

In addition to the highest robustness and reliability in its class, other key features of the Datalogic JET™ include fully integrated automatic data capture (barcodes, RFID tags and images) and superior wireless communication capabilities (WLAN, WWAN and WPAN). The PDA is equipped with a function-based keyboard for direct ERP transactions and with a web-based layout for HTML needs as well. These key requirements make the Datalogic JET perfect for use in field force automation, in-store and logistics applications.

The Datalogic JET™ enables companies and organizations worldwide to make more effective use of people and tools for receiving, storage, and shipping activities. For example, extended mobility allows simultaneous real-time inventory management and control of all stock movements to increase precision while minimizing operating costs. Data on store shelves, inventory levels and storage bins are immediately available to permit greater coordination and cut flow times.

The Datalogic JET™ provides mobile professionals with the most relevant features needed to operate in demanding environments: reliability, ruggedness, drop resistance, long lasting batteries, flexible communication and efficient data capture. To optimize mobile applications, a user-accessible memory slot is also present to backup data, extend databases, etc.

Thanks to a set of accessories, such as a vehicle cradle (standard and loud speaker), cigarette lighter power adapter, dashboard mounting kit, with state-of-the-art technology inside the PDA, the Datalogic Jet is the right answer for all data management needs on the move.

1.2 AVAILABLE MODELS

The brand new Datalogic Jet™ PDA is available in different models depending on the options it is equipped with. All options are listed below:

- data capture options: laser, imager, laser + RFID
- communication options: Wi-Fi 802.11b, GSM/GPRS, Bluetooth®
- data entry options: function oriented keyboard

For further details about the Datalogic Jet™ PDA models refer to the web site: <http://www.datalogic.com>.

1.3 PACKAGE CONTENTS

The Datalogic Jet™ PDA package contains:

- 1 Datalogic Jet™ PDA
- 1 CD-ROM Datalogic-NET SDK (Windows CE.NET SDK for Datalogic terminals)
- 2 styluses
- 3 adhesive pull tabs for Mini SD card
- 1 user's manual
- 1 rechargeable battery pack
- 1 adjustable elastic strap with stylus holder
- 1 belt clip
- 1 belt clip pivot

Any other packages will contain the accessories necessary for the Datalogic Jet™ PDA connection to the host computer and to the network: the cradle, power supply, and one or more connection cables. Remove all the components from their packaging; check their integrity and congruity with the packing documents.



CAUTION

Keep the original packaging for use when sending products to the technical assistance center. Damage caused by improper packaging is not covered under the warranty.



NOTE

Rechargeable battery packs are not initially charged. Therefore the first operation to perform is to charge them. See paragraph 4.1.

1.4 INSERTING MINI SD CARD

With Datalogic JET™ PDA, it is possible to add a Mini SD Card for additional storage capacity. To access the Mini SD card slot, unscrew the cover at the side of Datalogic Jet (see Figure A) and then proceed as follows:

1. Before inserting the Mini SD card, peel the adhesive pull tab and stick it onto the Mini SD card as shown in the picture below:



2. Open the Mini SD card slot by unscrewing the two screws:



3. Insert the card with the written part upward and push it until it clicks into place:



To remove the Mini SD card slightly push it toward the inside until it clicks; the card is released, pull it out using the adhesive pull tab.

1.5 ACCESSORIES

❑ Cradles

94A151096 Datalogic Jet™ Single Cradle Desk (includes slot for spare battery pack recharge; RS232 and USB communications)

94A151097 Jet™ Vehicle Cradle Loudspeaker

94A151100 Jet™ Vehicle Cradle Standard

❑ Charger

94A151098 Datalogic Jet™ Multi-Battery pack Charger (4 slots)

❑ Batteries

94ACC1293 Datalogic Jet™ Standard Battery pack (Li-Ion battery pack 1070 mAh@7.4 V)

94ACC1294 Datalogic Jet™ Large Capacity Battery pack (Li-Ion battery pack 1800 mAh@7.4 V)

❑ Power Supply

94ACC1286 PG12-10P35 AC/DC Power Supply without cord for Datalogic Jet™

94ACC1296 PG12-10P35 AC/DC Power supply EU KIT

94ACC1297 PG12-10P35 AC/DC Power supply UK KIT

94ACC1298 PG12-10P35 AC/DC Power supply US KIT

94ACC1299 PG12-10P35 AC/DC Power supply AUS KIT

94ACC4595 FPS18 Power Supply without cord for Datalogic Jet™ Single Cradle Desk and for Datalogic Jet™ Multi-Battery Charger

94ACC1150 Power cord EU 3-pin

❑ Cables

94A051008 WIN-NET SERIAL CABLE (HRS 3500-16P-CV) cable for RS232 direct connection between the PDA and the PC

94A051009 WIN-NET USB CABLE (HRS 3500-16P-CV) cable for USB direct connection between the PDA and the PC

94A051012 WIN-NET VEHICLE PWR CAB (HRS 3500-16P-CV) cable for powering Datalogic Jet™ from the car cigarette lighter

❑ Various

94ACC1287 Datalogic Jet™ Belt Holster

94ACC1288 Datalogic Jet™ Functional Case

94ACC1307 Datalogic Jet™ Functional Case Plus

94ACC1300 Datalogic Jet™ Backstrap Kit (2 pcs)

94ACC1308 Safe Shoulderstrap (5 pcs)

94ACC1301 Stylus Pen (20 pcs)

2 CONNECTIONS

2.1 PDA CONNECTION TO THE HOST COMPUTER

2.1.1 RS232/USB Direct Connection

You can use a cable to connect the Datalogic Jet™ PDA to a host computer to transfer data.

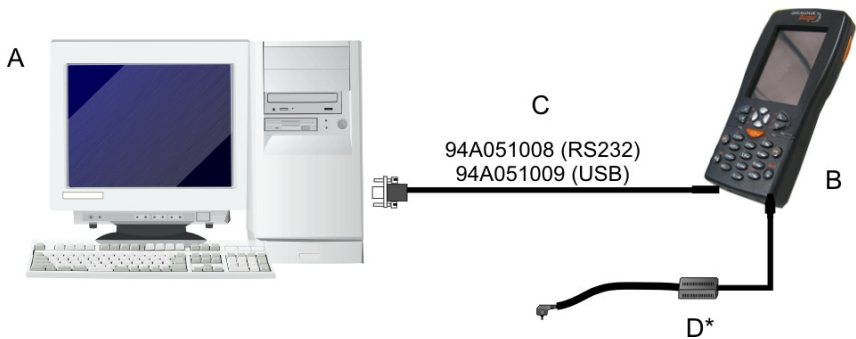

Key:

- | | | | |
|---|--------------------|---|---|
| A | Host computer | C | RS232 cable or USB cable |
| B | Datalogic Jet™ PDA | D | *Power Supply (only necessary for battery charging) |

* Recommended Power Supply: PG12-10P35 AC/DC Power Supply



CAUTION

USB communication may not be completely guaranteed while batteries are simultaneously in charge. Avoid the power supply connection when the USB link is active.

2.1.2 WLAN Connection

Datalogic Jet™ Wi-Fi models can communicate with the host using the on-board radio frequency module and an Access Point connected to the host computer.

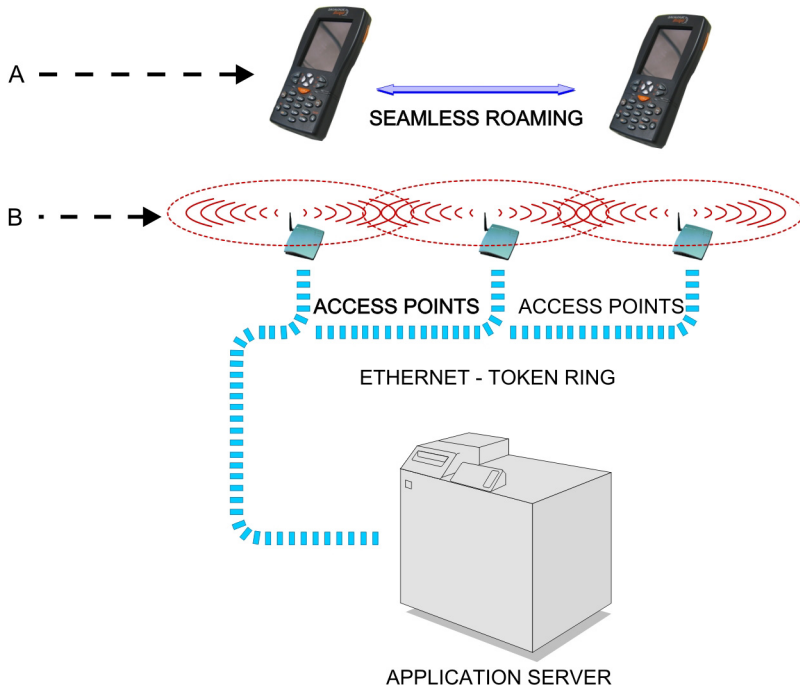

Key:

- A) Datalogic Jet™ PDA
- B) Access point



NOTE

In order to avoid wasting power, the Wi-Fi module is off by default. If you need to have the Wi-Fi module working, the module must be powered on using the Wireless Communications applet (see par. 3.7.4). To start configuring your WLAN connection, tap the Wi-Fi icon at the bottom of the screen.

2.1.3 WPAN Connection

Datalogic Jet™ PDAs can communicate with a Bluetooth® device, such as a printer, within a range of 10 m, using the on-board Bluetooth® module.



Key:

- A) Datalogic Jet™ PDA
- B) Bluetooth® printer



NOTE

In order to avoid wasting power, the Bluetooth® module is off by default. If you need to have Bluetooth® working, the module must be powered on using the Wireless Communications applet (see par. 3.7.4), and perform the Discovery procedure (see par. 3.8.2).

The Blue LED flashing signals that the Bluetooth® module is on.

2.1.4 WWAN Connection

Datalogic Jet™ GSM/GPRS models enhance your connectivity solutions giving you an opening to an international wireless infrastructure that is the standard in Europe and Asia.

GSM (Global System for Mobile communications) is a digital mobile phone system based on TDMA; it utilizes the 900, 1800 and 1900 MHz bands. GPRS supports IP (Internet Protocol) and allows accessing Internet and Intranet services, such as sending and receiving e-mail or Web browsing.

In order to use a WWAN Connection you have to install a SIM Card (see instructions on the following page).



NOTE

In order to avoid wasting power, the GSM/GPRS module is off by default. If you need to have GSM/GPRS working, the module must be powered on using the Wireless Communications applet (see par. 3.7.4).



Installing the SIM Card

To correctly insert the SIM Card, proceed as follows:

- 1- Turn off the Datalogic Jet™ PDA.
- 2- Press the latch release button and pull the battery latch down as indicated in the figures below:



- 3- Remove the battery pack to have access to the SIM card slot:



- 4- Open the Sim Card slot by pulling up the locking plate.



- 5- Pull up the cardholder and insert the Sim Card with its contacts downward and its round corner at the bottom.



- 6- Lock the card into place by pushing the cardholder down and then pulling the locking plate down.

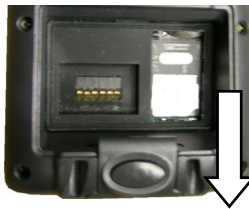

Removing the SIM Card

To remove the SIM card, follow the steps above to access the SIM area, and remove it from its slot.

2.2 CONNECTION CABLES

The following cables are listed with their order number.

- **RS232 Direct Connection:**
94A051008 WIN-NET SERIAL CABLE (HRS 3500-16P-CV)

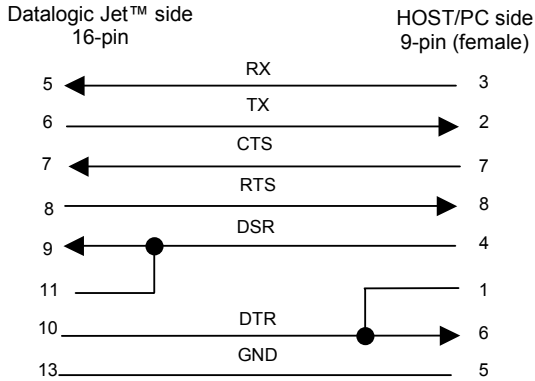

- **USB Direct Connection:**
94A051009 WIN-NET USB CABLE (HRS 3500-16P-CV)

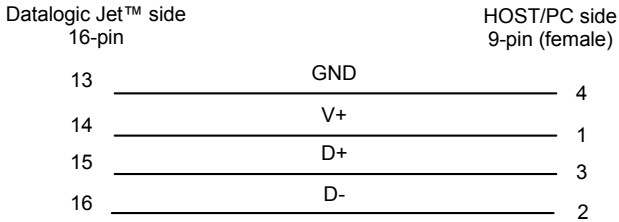

- **Power Supply Polarity:**

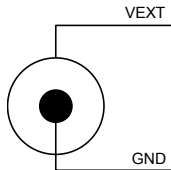

3 USE AND FUNCTIONING

The use of the Datalogic Jet™ PDA depends on the application software loaded. However there are several parameters that can be set and utilities that can be used to perform some basic functions such as data capture, communications, file management, etc.

3.1 PDA STARTUP

The Datalogic Jet™ PDA turns on when the battery pack or the external supply is inserted.

After the battery pack is installed, use the [ON/OFF] key to turn the PDA on and off.

As soon as the PDA is on, the Windows CE .NET desktop configuration will appear on the screen. Wait a few seconds before starting any activity so that the PDA completes its startup procedure.



Use the stylus as suggested in paragraph 3.2 to select icons and options.

When it is no longer used for more than a programmable timeout, which is defined in the POWER applet of the Control Panel, the PDA goes into power-off (low power with display and keyboard backlight off). In this mode it can be awakened (resuming operation) by the [ON/OFF] key.

**NOTE**

The PDA can also be awakened or turned off by the application program.

3.2 USING THE STYLUS

The stylus selects items and enters information. The stylus functions like a mouse.

Tap:	Touch the screen once with the stylus to open items and select options.
Drag:	Hold the stylus on the screen and drag across the screen to select text and images. Drag in a list to select multiple items.
Tap-and-hold:	Tap and hold the stylus on an item to see a list of actions available for that item. On the pop-up menu that appears, tap the action you want to perform.

The stylus is factory aligned; however, it is possible to align the cursor on the screen with the tip of the stylus. Enter the STYLUS applet of the Control Panel and tap the center of each target that appears on the screen with the tip of the stylus.

3.3 DATA CAPTURE

To configure and enable data capture parameters refer to par. 3.6.

3.3.1 Laser Data Capture

To scan barcodes, point the Datalogic Jet™ PDA laser model onto the code from a distance within the reading range while pressing one of the three SCAN Keys. See the reading diagrams in par. 5.2 for the reading range of your model.

The lighted band emitted by the laser must completely intercept the barcode as shown in the figure below. If enabled, the emission of an acoustic signal will indicate that the scan has taken place correctly.

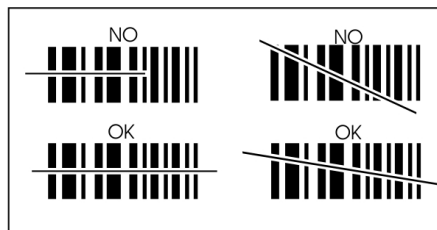
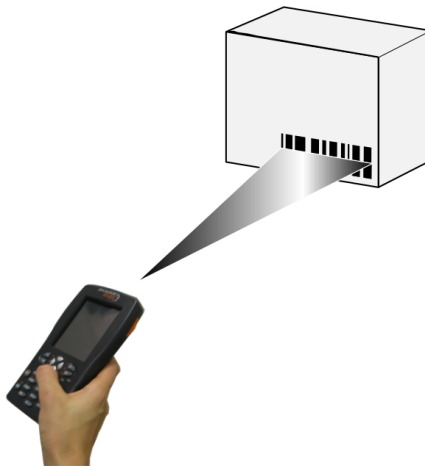

3.3.2 Imager Data Capture

To read a 1D or 2D code, simply point the Datalogic Jet™ Imager model onto the code from a distance within the reading range (see par. 5.1, section Datalogic Jet™ Imager Optical Features) and press one of the three SCAN Keys.



The Datalogic Jet™ Imager uses an intelligent aiming system pattern, similar to those on cameras, indicating the field of view, which should be positioned over the code:

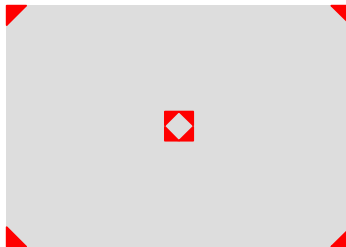

Aiming System

If the aiming system pattern is centered over the entire symbology as shown in the following figure, either wait for the timeout or release the Scan key to capture the image.

A red beam illuminates the code, which is captured and decoded. You will get a good read.

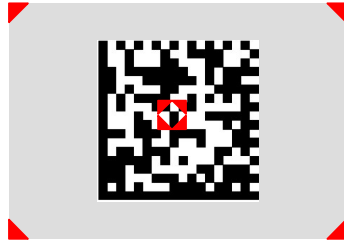
Linear barcode**2D Matrix symbol**

Relative Size and Location of Aiming System Pattern

The field of view changes its size as you move the reader closer or farther away from the code. The field of view indicated by the aiming system pattern will be smaller when the Datalogic Jet™ Imager is closer to the code and larger when it is farther from the code.

Symbologies with smaller bars or elements (mil size) should be read closer to the unit. Symbologies with larger bars or elements (mil size) should be read farther from the unit. (See par. 5.1 for further details).

3.3.3 RFID Data Capture

To read or write a tag, place the Datalogic Jet™ PDA so that the RFID emission window is in front of and almost in contact with the tag, then press one of the three SCAN Keys or the application-defined key.



3.4 DESCRIPTION OF THE KEYS

The Datalogic Jet™ PDA provides a function-oriented keyboard having a total of 27 keys.

The keyboard can be divided as follows:





3.4.1 System Control and Navigation Keys

- On/Off**



Powers the PDA ON or OFF.
- 

They let you move forwards or backwards within the Internet Explorer browser pages.
- 

They let you move forwards, backwards, upwards or downwards within Text fields, scroll through a Menu list or browse among folder files.
- 

Switches on/off the keyboard backlight. The backlight automatically turns off after a set timeout.

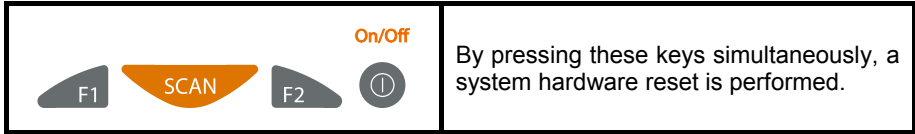
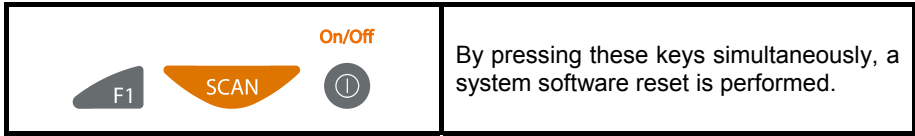

3.4.2 Key Selection

The following figure shows the Datalogic Jet™ PDA keyboard:

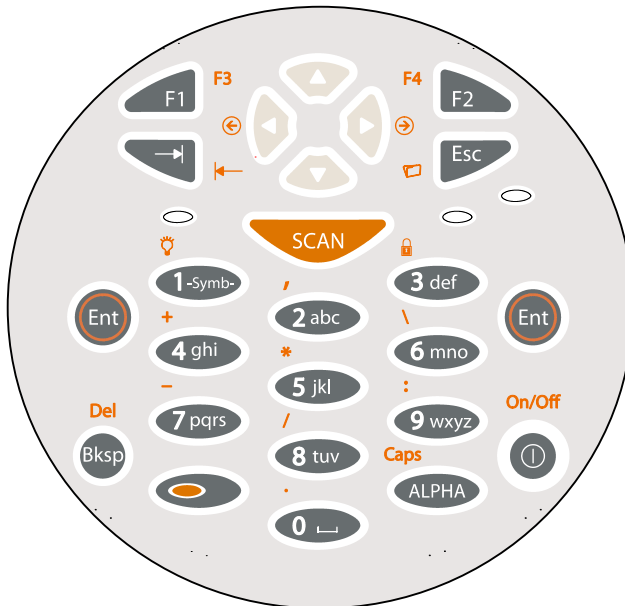

Some of these keys carry extra symbols and are logically divided in up to 3 sections according to the following figure:

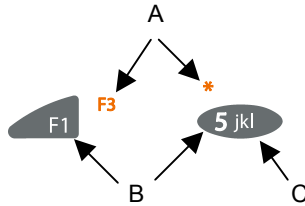

Each section corresponds to a symbol that can be obtained using the corresponding keyboard method according to the following scheme:

- A) function of the key when simultaneously pressed along with the Orange key;
- B) function of the key when directly pressed;
- C) function of the key when in Alpha mode, in order to digit all the alphabetic characters positioned over the keys.



It starts Data capture.



The ORANGE key pressed simultaneously along with any other keyboard key enables the character positioned above or at its right/left side (in case of keys displayed at the top of keyboard).

Ex: ORANGE key + [5 jkl] key corresponds to the * character.



When in alphanumeric mode, by pressing repeatedly the key, you can scroll through a list of punctuation signs and symbols and select the desired one by a timeout.



It enters a special mode through which it is possible to digit all the alphabetic characters positioned over the keys.

Ex: [7pqrs] in alphanumeric mode: press once for 'p', twice for 'q', three times for 'r', four times for 's'. To exit the Alpha mode and return to the keyboard normal functioning it is necessary to press the Alpha key again.



It locks and unlocks the Keyboard.



It corresponds to pressing ALT-F on a standard PC running Windows that is it opens the first entry of a drop-down Menu.



Switches on/off the keyboard backlight. Both display and keyboard backlight automatically turn off after a timeout, depending on Control Panel settings.
The backlights automatically turn off after a set timeout.



NOTE

Once the Alpha mode has been entered, press the Alpha key again to exit this mode.

3.5 STATUS INDICATORS







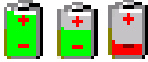

3.5.1 LED Status

The Datalogic Jet™ provides three different LEDs signaling the PDA status.

LED	STATUS	
General Purpose (left-side)	Green/Red	This LED is available to the application program.
Bluetooth® (extreme right -side)	Blue blinking	It blinks when the Bluetooth® module is on.
Charging Status (right side)	Green constant	It is constant once the charging process has been completed.
	Red blinking	It blinks when the battery pack is running down.
	Red constant	It is constant while charging.
	Green/Red	They turn on alternatively while discharging.
	Orange blinking	It blinks when a charging error has occurred, for example when the external power is connected but no battery is inserted.

3.5.2 Status Bar

The Status Bar provides information about the time, the battery level, the keyboard function, and the decoding status.

ICONS	DESCRIPTION
Time and Battery Icons	
10.50	It shows the time.
	They are representative of five different icons indicating the battery level. The icon is green or red colored according to the power left (green when >20%, red when <20%).
	It shows the battery is charging.
Keyboard Status Icons	
	It shows the Keyboard is in FUNC mode.
	It shows the Keyboard is in ALPHA mode.
	It shows the Keyboard is in Normal mode.
	It shows the Capslock is active.
	It shows the Keyboard is locked.
Decoding Status Icons	
	It shows the decoder is active.
	It shows the decoder is not active.



Status Bar

3.6 DATA CAPTURE CONFIGURATION

From the Taskbar, tap the "Data Capture" icon to open a drop-down menu. Data Capture can also be accessed from the Control Panel.



By selecting the *Info* item from this drop-down menu you can access information about the Scanner and the Software; the *Configure* item opens the configuration applet (Data Capture Configuration Window), while *Capture* accesses the data capture applet (Data Capture Window), which enables code reading. The last menu item (*Wedge*) enables Wedge Emulation.

3.6.1 Configure

The Configuration applet contains the barcode scanning configuration parameters in a directory tree structure. The available barcode parameters are divided into two groups: Reader Parameters and Scan Parameters.

The Reader Parameters depend on the type of scanner module installed on the PDA and allow barcode configuration (i.e. enable/disable Code 39, check digit control, etc.).

The Scan Parameters are common to all scanner modules and allow control of the scanning device (i.e. beeper control, LED control, laser timeout, etc.).

Each Data Capture screen window corresponds to a branch of the tree, and the name of the current branch is displayed at the bottom of each screen window.

Alternatively using the stylus, you can tap once directly on the value on the right column; continue tapping until the desired value is reached.

To activate a new configuration select the File ->Save Menu to send the new configuration to the barcode decoding software and save the new configuration. This will save the configuration to non-volatile memory preventing loss at the next system reset.

Reader Parameters

The barcode reading parameters and values are dependent upon the type of scanner module mounted in your PDA. For a detailed list of parameters and of their configuration procedures, please refer to the SDK Help file on the CD.

Scan Parameters

The Scan Parameters are common to all scanner modules and allow control of the scanning device. The Scan parameters are described as follows:

ScanTimeout: the maximum time, in milliseconds, during which the scanner remains on without decoding any barcode.

GoodReadSound: is the filename of a .wav file played when the scanner reads a code.

LedDuration: the length of the good-read led pulse, in milliseconds.

LedPulses: the number of times the good-read led pulse is emitted when the scanner reads a barcode.

ContinuousMode: when enabled, the scanner can only be turned off by releasing the SCAN key, or if Soft Trigger is enabled, by the application program. Continuous Mode overrides Scan Timeout.

KeyboardEmulation: if enabled all scanned data are transformed into keyboard events and can therefore be displayed and saved to a file as if input from the PDA keyboard. If set to "Yes (Clipboard)", it copies the scanned data to the system clipboard.

SoftTrigger: when enabled, the laser can be turned on/off by the application software.

ScanAlwaysOn: enables the scanner for barcode reading independently from the application software. If set to "Disabled after read", it disables the reading after a reading attempt. In case the scan button is accidentally pressed, this selection prevents the driver from decoding new data while the application is still elaborating previous data.

NotPrintableChar: if set to "Remove", all not printable characters included in the scanned data are deleted and the final barcode will include only printable characters.

Default Settings

The following tables contain the default values for the major barcode setup parameters, according to the type of scan engine mounted on the PDA. For a complete list of parameters and of their configuration procedures, please refer to the SDK Help file on the CD.

SCAN PARAMETERS	HP Laser	Imager	RFID+Laser
ScanTimeout	5000	Not available	5000
GoodReadSound	Beep.wav	Beep.wav	Beep.wav
LedDuration	200 ms	200 ms	200 ms
LedPulses	1	1	1
ContinuousMode	Disabled	Disabled	Disabled
KeyboardEmulation	Disabled	Disabled	Disabled
SoftTrigger	Enabled	Enabled	Enabled
ScanAlwaysOn	Disabled	Disabled	Disabled
NotPrintableChar	Leave	Leave	Leave

BARCODE SYMBOLOGY SPECIFIC READER PARAMETERS	HP Laser	Imager	RFID+Laser
UPC A	Enabled	*	Enabled
UPC E	Enabled		Enabled
EAN 8	Enabled		Enabled
EAN 13	Enabled		Enabled
UPC E1			Disabled
EAN Bookland			Disabled
UPC/EAN/JAN		Enabled	
Code 39	Enabled	Enabled	Enabled
Code 39 Full ASCII	Disabled	Disabled	Disabled
Code 32	Disabled		Disabled
Code 39 Trioptic			Disabled
2/5: Interleaved	Enabled	Enabled	Enabled
2/5: Industrial	Disabled		Disabled
2/5: Matrix	Disabled		
Code 128	Enabled	Enabled	Enabled
EAN 128	Enabled	Disabled	Enabled
ISBT 128			Disabled
Codabar	Enabled	Enabled	Disabled
RSS		Disabled	

*In the Imager models these codes may only be enabled or disabled as a group by the UPC/EAN/JAN family selection (see a few lines below).

BARCODE SYMBOLOGY SPECIFIC READER PARAMETERS	HP Laser	Imager	RFID+Laser
MSI	Enabled		Disabled
Plessey	Disabled		
Code 93	Disabled	Enabled	Disabled
Code 11	Disabled		
PDF - 417		Enabled	
Data Matrix		Enabled	
QR		Enabled	
POSTNET		Disabled*	
PLANET			
Japan Post			
Australia Post			
KIX Code			
Royal Mail Code (RM4SCC)			

*These codes may be enabled individually but are disabled as a group.

RFID SYMBOLOGY PARAMETERS	RFID+Laser
Data Type	I.CODE Iso-15693
Read Type	Identifier

3.6.2 Capture

The Data Capture applet (Capture) enables code reading.

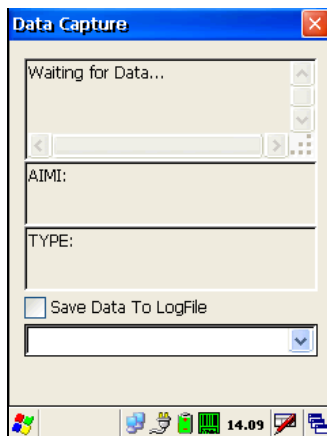

Data Capture Window

Data Capture can also be enabled through the Configuration applet by selecting File ->Scanner from the main menu, or by enabling the parameter Scan Always On in the Scan Parameters branch.

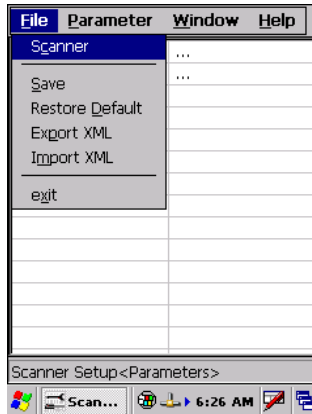

Enabling the Data Capture

3.7 CONTROL PANEL

From the Desktop, double tap on the "Control Panel" icon to open the Windows CE .NET control panel main window. The Control Panel can also be launched from Start ->Settings ->Control Panel.

APPLET programs are displayed as icons; one icon corresponds to each APPLET.

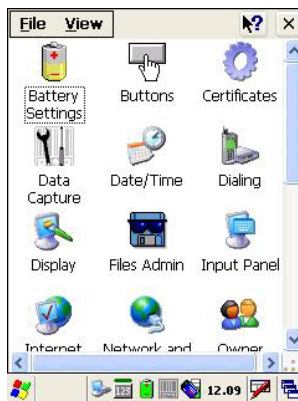

Control Panel

3.7.1 Buttons

The BUTTONS Applet allows assigning desired applications to be launched by the Act button or one of the function keys (F1, F2, F3).



3.7.2 Registry

The REGISTRY ADMIN applet provides management of Windows CE .NET registry.

Select the REGISTRY ADMIN applet by double tapping the Registry Admin icon.

The Registry Administration Main window appears. Two functions are available:

- Save Registry allows permanently saving the Windows configuration (example: custom configuration of screen desktop background color, or network adapter configuration) to non-volatile memory (SAVE button).
- Restore Default Registry allows restoring the initial factory default configuration (Restore Default button). After restoring the factory default configuration, you must perform a software reset (see par. 3.4.1).

Saving the registry to non-volatile memory guarantees the persistence of the Windows configuration in case of battery pack replacement.

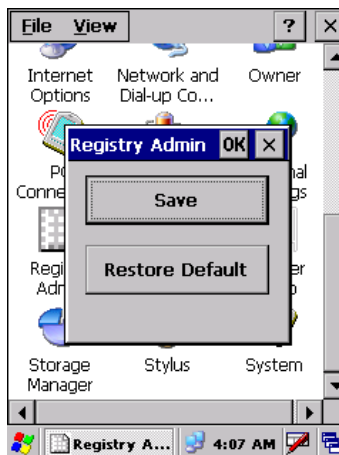

Registry Administration Window

3.7.3 Files Admin

The FILES ADMIN applet enables control of the permanence of files in the System Folder. Two functions are available on the Files Admin Main window by means of two buttons:

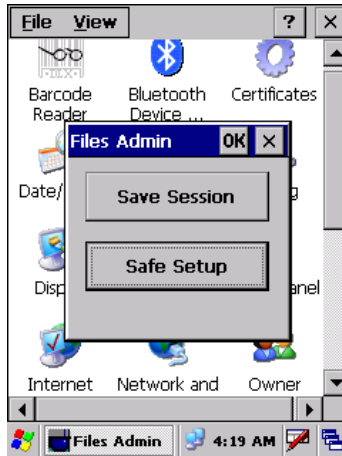

Files Admin Main Window

Save Session: with this button all files will be permanently saved in the \Windows directory in non-volatile memory. This function guarantees the steady maintenance of every file produced during the current working session - even of sub-directories and relevant files - with the exception of the files belonging to the FLASH image. These current working session files will be backed-up in the \Backup\Windows directory.

At the next hardware reset, the files previously saved in the \Backup\Windows directory will be restored to the Windows directory (see par. 3.9).

Safe Setup: with this button, the installation of software programs will be saved to non-volatile memory (Backup directory). Before doing this, it will be checked that the Backup directory has enough space to save the files. If the directory space is not enough, an error message will be shown and the program will exit the Safe Setup function.

Two activating procedures are available for Safe Setup:

- Select an installation file (for example, a .CAB cabinet file) from the Safe Setup mask.

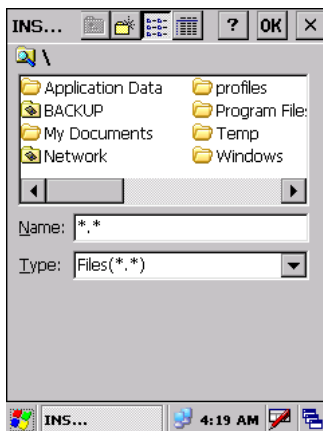

Safe Setup First Mask

Then select \\Windows or a relevant sub-directory in the path box. Then, Safe Setup will recognize the new files and directories present in the \\Windows directory, and will copy them to the \\Backup\\Windows directory. At the next hardware reset, these files will be restored (see par. 3.9).

- Simply skip the first mask either by closing it or by pressing the ESC key. When it closes, a new mask will pop up: it will enable any type of installation (even remote ones like ActiveSync® installations). Make sure the installation directory is \\Windows or one of its sub-directories. After installation, tap OK: Safe Setup will save the new files in the \\Backup\\Windows directory.

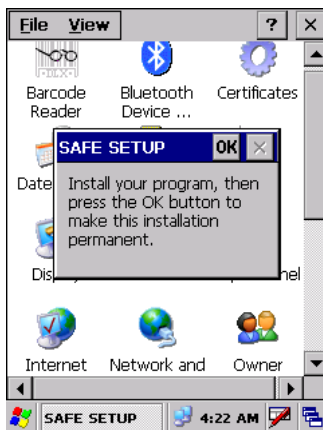

Safe Setup Second Mask

3.7.4 Wireless Communications

The WIRELESS COMMUNICATIONS applet provides management of the Wi-Fi Card and of the Bluetooth® and GSM/GPRS modules.



Select the WIRELESS COMMUNICATIONS applet by double tapping the Wireless Communications icon. The following window will appear:

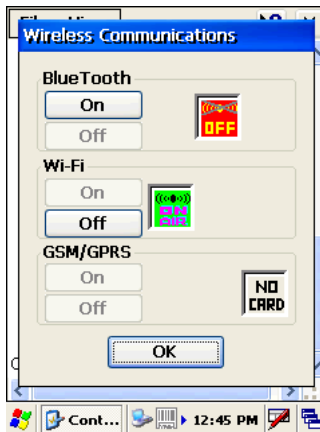

Wireless Communications Window



NOTE

In order to avoid wasting power, all modules are off by default.

3.7.5 Volume Settings

The Volume Settings applet allows managing the audio features and appears as follows:

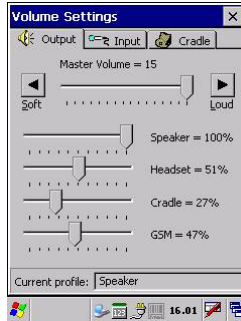

Volume Settings Window

The window is divided into three tabs:

- **Output** tab: allows setting the volume for each audio profile;
- **Input** tab: allows setting the microphone recording volume;
- **Cradle** tab: allows selecting the cradle type and managing the vehicle cradle headset functioning.

The Status bar always displays the current audio profile, which is activated automatically (by the device) or manually (by the user). Available profiles are:

- **Speaker**: it is the typical profile reproducing audio through the mobile computer speaker;
- **Cradle**: it is automatically activated as soon as the mobile computer is inserted into the vehicle cradle. Audio is reproduced by the vehicle cradle loudspeaker.
- **Headset**: it is automatically activated as soon as a headset is directly connected to the mobile computer. In case the device is inserted into the vehicle cradle and the headset is connected to the cradle, this profile must be manually activated through the dedicated button (refer to “Cradle Tab” paragraph). When this profile is active, the speaker does not work;
- **GSM**: it is automatically activated each time a phone-call is started. It is not available when using the cradle loudspeaker (in this case Current Profile = Cradle).

Output Tab

It allows setting the volume for each audio profile:

The “Master Volume” slider allows setting the volume used by all audio profiles. In addition, it is possible to attenuate the volume for each single profile through the dedicated slider.

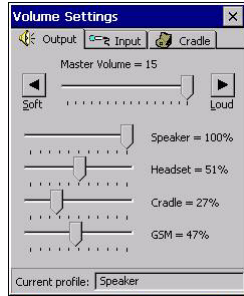

Input Tab

It allows setting the microphone recording volume:

The “Record Gain” slider allows setting the recording volume, while the “Enable Preamplifier” check box enables/disables the preamplifier (this option is not selectable when Current Profile = Cradle or GSM).



Cradle Tab

It allows selecting the cradle type and managing the vehicle cradle headset functioning:

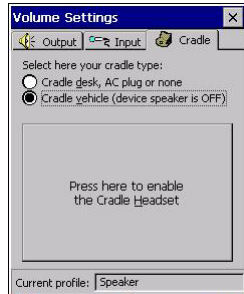
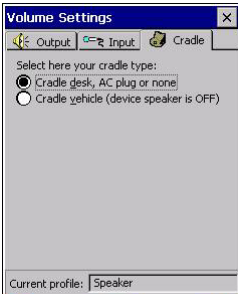

Two radio buttons allow selecting the type of cradle to be used.

Check the “Cradle desk, AC plug or none” radio button, if using a cradle different from the vehicle cradle or an AC adapter plug.

If using a vehicle cradle, check the related radio button.



NOTE

By inserting the mobile computer into the cradle when the “Cradle vehicle” radio button is checked, the mobile computer speaker is deactivated and audio will be reproduced through the vehicle cradle speaker or headset.

By selecting the “Cradle Vehicle” check box, a further button will appear allowing to enable the headset profile when using the vehicle cradle. If pressed, the button displays the headset icon in gray until the device is inserted into the vehicle cradle. Once inserted, the headset icon turns to green and the device activates the headset profile (refer to the following figures). Actually, the headset is ready to reproduce audio as soon as it is connected to the cradle jack:



WARNING

Do not use the vehicle cradle headset if the headset button is disabled, since it may cause hearing damage.

3.8 WINDOWS CONNECTIONS

From the Desktop, double tap on the "Connections" folder to open the following window:

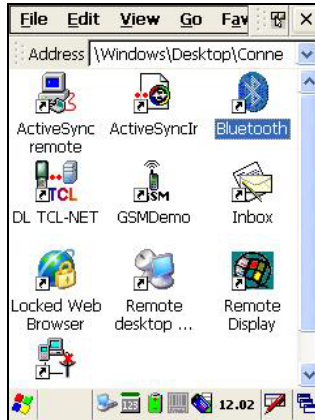

Windows Connections

3.8.1 Microsoft® ActiveSync®

Microsoft® ActiveSync® gives you the possibility to connect your desktop computer to your Datalogic Jet™ PDA and synchronize the information on them. Synchronization compares the data on the Datalogic Jet™ PDA with that on the desktop computer and updates both computers with the most recent information.

With ActiveSync®, it is possible to:

- Back up and restore Datalogic Jet™ PDA data.
- Copy files between Datalogic Jet™ PDA and desktop computer.
- Synchronize files by selecting a synchronization mode.

It is possible to constantly synchronize while connected to a desktop computer or, alternatively, synchronization can be performed only when the synchronize command is chosen. You can select which information types are synchronized and control how much data is synchronized.



NOTE

By default, ActiveSync® does not automatically synchronize all types of information. Use ActiveSync® options to turn synchronization on and off for specific information types.

For example:

Synchronize Microsoft Word and Microsoft Excel files between the Datalogic Jet™ PDA and the desktop computer. The files will automatically be converted to the correct format.

You can establish a connection by Serial cable, by USB cable or by network. Moreover, if you have a Datalogic Jet™ Single Cradle you can connect your Datalogic Jet™ PDA putting it into the cradle and using a standard A-B USB cable or a standard Serial null modem cable.



NOTE

*Visit the following Microsoft Web site for the latest in updates, technical information, and samples:
<http://www.microsoft.com/windowsmobile/resources/downloads>*

ActiveSync® Remote

After a Partnership between PDA and desktop computer is established, it is also possible to establish a remote connection via Wireless LAN: disconnect the actual connection via ActiveSync® by double tapping the ActiveSync® connection icon on the taskbar and press Disconnect, then go to the \Windows\Desktop\Connection folder and double tap the ActiveSync® remote icon. In the dialog box that will appear it will be possible to choose a method to connect to the desktop computer. Choose Network Connection and press the Connect button:



NOTE

To set up your network connection you have to correctly set up your wireless connection. These settings depend on the wireless card that you have installed on your Datalogic Jet™ PDA and on your wireless network settings. For more information about these settings contact your network administrator.

3.8.2 Bluetooth® Manager Device Setup

In order to enable a Bluetooth® device for communication with the Datalogic Jet™ PDA you must perform the discovery procedure and enable the device as follows:

1. Place the Bluetooth® device within the range of the Datalogic Jet™ PDA (10 meters).
2. From the “Connections” folder double tap on the “Bluetooth” applet to open the Bluetooth® Manager Device window:



- Tap on the “Me” button to enter the related window; then, tap on the “ON” button to activate the Bluetooth® module. The module activation may be also performed by using the WIRELESS COMMUNICATION applet as described in par. 3.7.4.



By tapping on the “HW Details” and “SW Details” buttons, information about the PDA Bluetooth® hardware and software will be displayed, while the “Enable Encryption” button starts encryption of the Bluetooth® communication data. If tapping on the “Close” button the Bluetooth® Manager Device window will be closed.

- Tap on the “Discovery” button to enter the related window; then, tap on the “Scan” button to run the Discovery procedure:



Once the Discovery procedure has been completed, select the desired Bluetooth® device from the list. It is also possible to digit (12 hexadecimal digits) the Bluetooth® address of the desired device by tapping on the “Add” button. The “Clear” button deletes all discovered devices from the list.

5. Once the desired Bluetooth® device has been selected, tap on the “Connection Wizard” button to enter the related window where selecting the connection type to be used for communication with the Bluetooth® device:



The “Serial Port” button starts communication through the Bluetooth® serial port COM 5 (typically used for connection with GPS devices).

The “Printer” button starts communication with a printer through the Bluetooth® serial port COM 5.

The “Kbd Emulation” button allows connection with a barcode reader using the keyboard emulation.

The “ActiveSync” button starts communication with a PC equipped with a Bluetooth® antenna and the related ActiveSync.

6. Hide the Bluetooth® Manager Device window by tapping on the  icon available on each window or close it through the “Close” button available in the “Me” window (see step 3 of this procedure).

3.9 BACKUP DIRECTORY FILE MANAGEMENT

All of the Windows CE .NET system files reside in RAM (volatile memory) except for the Backup directory, which resides in FLASH (non-volatile memory). Therefore the contents of the Backup directory are persistent even if the PDA is re-booted or the battery pack is changed.

You can save your more important files that you don't want to lose due to PDA re-boot, in the Backup directory or create a sub-directory within Backup.

Even though the Windows Directory resides in RAM, it often contains files or sub-directories created by the user or by installation programs that you don't want to lose at re-boot. To keep these files persistent it is necessary to copy them to the directory \Backup\Windows. This directory doesn't exist originally (only Backup exists), and therefore it must be created. At the next hardware reset, before activating the shell, Windows CE .NET will copy the contents including all sub-directories of \Backup\Windows to \Windows.

Likewise, to maintain files that must be run at Windows CE .NET startup, (i.e. .exe, .lnk, .vb, .htm, etc.), it is necessary to copy them to the directory \Backup\Startup. This directory does not exist originally (only Backup exists), and therefore it must be created. The application programs will be run after any type of re-boot (both software and hardware reset).

As an alternative to the Safe Setup function, it is possible to copy the .cab files to the directory \Backup\Cabfiles (the Cabfiles sub-directory doesn't exist originally and must therefore be created) and perform a PDA cold boot to have the application installed. Once these files are copied to the directory \Backup\Cabfiles, the application will be run after each re-boot.

From the second cold boot on, a message may be displayed such as "<application name> is already installed. Re-install?". This message blocks the boot process. Press the [Enter] key to continue the system initialization.

4 MAINTENANCE

**NOTE**

Rechargeable battery packs are not initially charged. Therefore the first operation to perform is to charge them. See below.

4.1 CHARGING THE BATTERY PACK

The battery pack autonomy varies according to factors, such as the frequency of barcode scanning, RF usage, etc.

When the battery pack is low, the red LED positioned at the left side of the display blinks.

It is possible to recharge the battery pack by using the PG12-10P35 AC/DC external power supply directly connected to the Datalogic Jet™ PDA, see par. 2.1.1.

Alternatively, it is also possible to recharge the battery pack by using the Datalogic Jet™ Single Cradle Desk or the Datalogic Jet™ Vehicle Cradle.

The charging process is signaled by a bi-colored charging status LED positioned at the right side of the display (see par. 3.5).

If the battery pack is removed from the PDA, it can be recharged by inserting it into the Datalogic Jet™ Multi-Battery pack Charger.

**CAUTION**

If the battery pack is new or has not been recharged for a long time, it is necessary to perform two or three charging and discharging cycles (complete use) before it can reach its maximum charge capability.

The maximum time required to recharge a completely run-down battery pack is about 2.5 hours for Li-Ion batteries.

4.2 REPLACING THE BATTERY PACK

To correctly replace the battery pack, proceed as follows.

1. Turn off the Datalogic Jet™ PDA.
2. Press the latch release button and pull the battery latch down as indicated in the figures below:



3. Remove the battery pack.



- Replace the battery pack by pressing the latch release button and pulling the battery latch down, and then by inserting it towards the speaker and pressing it into the Datalogic Jet™ PDA until the battery latch is automatically closed:





CAUTION

When the latch release button is pressed, the PDA automatically shuts off, in order to retain data during the pack substitution. After the new pack insertion, be sure that the battery latch has completely slid over the pack so that the latch release button is released.



WARNING

Do not incinerate, disassemble, short terminals or expose to high temperature. Risk of fire, explosion. Use specified charger only. Risk of explosion if the battery is replaced by an incorrect type. Dispose of the batteries as required by the relevant laws in force.



NOTE

In order to guarantee an adequate operating autonomy, when replacing the battery pack the PDA checks the battery energy level. If the battery is not sufficiently charged, Datalogic Jet™ does not turn on (when pressing the ON button). In this case, either substitute the battery pack with a charged one (sufficiently charged) or insert Datalogic Jet™ into a powered cradle or plug it into the direct power supply.

4.3 CLEANING THE PDA

Periodically clean the Datalogic Jet™ PDA with a slightly dampened cloth. Do not use alcohol, corrosive products or solvents.

5 TECHNICAL FEATURES

5.1 TECHNICAL DATA

Datalogic Jet™ Common Features

Electrical Features		
Power		
	DC supply	12 to 14 V ± 5%
	Battery pack	2 cell Li-Ion 1070 mAh@ 7.4 V (nominal)
	Large capacity pack	2 cell Li-Ion 1800 mAh@ 7.4 V (nominal)
	Internal backup battery	Rechargeable Li-Ion 30 mAh
Communication Features		Windows CE.NET COM Port
	Bluetooth interface	COM5
	Serial interface	RS232 USB 1.1
		COM1 COM6
Wireless Features		
	WLAN	IEEE 802.11b DSSS
	WPAN	Bluetooth® IEEE 802.15, Class 2, Version 1.2
	WWAN	GSM/GPRS Tri-band (900, 1800, 1900 MHz) Radio with accessible SIM card interface
Environmental Features		
	Working temperature*	-10° to + 50 °C / +14° to +122 °F
	Storage temperature	-20° to +70 °C / -4° to +158 °F
	Humidity	90% non condensing for temperatures < 40°C
	Protection	IP64
	ESD protection	4 KV contact discharge, 8 KV air discharge
	Drop resistance	1.5 m / 5 ft
Hardware Features		
	FLASH	128 MB
	DRAM	128 MB
	Microprocessor	Intel XScale PXA 270 520 MHz
	Accessible card socket	Mini SD
	Audio	Speaker, Microphone, Headset Jack
	LED	Two-color Programmable LED Charging Status (two-color LED) Bluetooth® (blue LED)
	Display	64K Color TFT LCD with 320 x 240 pixel resolution, with LED backlight and touch screen
	Keyboard	25 Plastic Top Backlit Keys plus Power Button plus 2 Lateral Push-buttons

* Batteries must be charged at a temperature ranging from 0° to +45 °C (+32° to +113 °F).

Mechanical Features	
Dimensions (LxWxH)	17.6 x 9 x 2.8 cm / 6.9 x 3.5 x 1.1 in
Weight (depending on model)	424– 465 g / 14.9–16.4 oz (incl. battery)
Programming Features	
Operating system	Windows CE.NET 5.0
HP Laser models	
Decoded barcodes 1D	UPCA A, UPC E, EAN 8; EAN 13, Code 39, Code 39 Full ASCII, Code 32, Interleaved 2 of 5, Industrial 2 of 5, Matrix 2 of 5, Code 128, EAN 128, Codabar, MSI, Plessey, Code 93, Code 11
RFID + Laser models	
Decoded barcodes 1D	UPC A, UPC E, UPC E1, EAN 8, EAN 13, EAN Bookland, Code 39, Code 39 Full ASCII, Code 32, Code 39 Trioptic, Interleaved 2 of 5, Industrial 2 of 5, Code 128, EAN 128, Codabar, MSI, Code 93
Decoded RFID Tags	EMS HMS Series, EMS LRP ISO15693 Series, Philips Mifare Classic 1k (read/write block only), Philips Mifare Classic 4k (read/write block only), Philips Mifare Ultralight, Philips I-Code SLI ISO15693, Texas Tag-It HF-I ISO15693, Infineon ISO15693
Imager models	
Decoded barcodes 1D	UPC A, UPC E, EAN 8, EAN 13, UPC/EAN/JAN, Interleaved 2 of 5, Code 39, Code 39 Full ASCII, Codabar, Code 128, EAN 128, Code 93.
Decoded barcodes 2D	PDF417, DataMatrix, QR, MacroPDF, RSS.
Postal codes	POSTNET, PLANET, Japan Post, Australia Post, KIX Code, Royal Mail Code (RM4SCC)

Datalogic Jet™ HP Laser / RFID +Laser Optical Features

Optical Features		
	Datalogic Jet™ HP Laser	Datalogic Jet™ RFID + Laser
Maximum resolution	0.13 mm / 5 mils	0.13 mm / 5 mils
Skew angle	± 55 °	± 60°
Pitch angle	± 65°	± 65°
Scan rate	35 ± 5 scan/sec	39 ± 3 scan/sec
Depth of field	See reading diagrams on the next page	
Light source laser scanner	VLD, wavelength 630~680 nm	
Safety class	Class II EN 60825-1/CDRH	

Datalogic Jet™ Imager Optical Features

Optical Features			
Max. resolution			
1D Codes 0.10 mm / 4 mils			
2D Codes 0.17 mm / 6.6 mils			
Skew angle $\pm 40^\circ$			
Pitch angle $\pm 35^\circ$			
Depth of field*			
1D (linear):	X-dimension mm (mils)	Symbol size cm (in)	DOF cm (in)
Code39	0.13 (5)	1.2 (0.47)	8.0 to 15.0 (3.15 to 5.90)
	0.50 (20)	3.2 (1.26)	8.0 to 33.0 (3.15 to 12.99)
EAN13	0.33 (13)	3.1 (1.22)	7.5 to 24.5 (2.95 to 9.65)
2D:	X-dimension mm (mils)	Symbol size cm (in)	DOF cm (in)
POSTNET	0.5 (20)	4.0 x 0.4 (1.57 x 0.16)	11.5 to 30.0 (4.53 to 11.81)
PDF417	0.13 (5)	1.1 x 0.9 (0.43 x 0.35)	8.5 to 15.5 (3.35 to 6.10)
	0.17 (6.6)	1.4 x 1.2 (0.55 x 0.47)	7.0 to 19.0 (2.76 to 7.48)
	0.25 (10)	2.2 x 1.8 (0.86 x 0.71)	4.5 to 24.0 (1.77 to 9.45)
QR	0.25 (10)	0.7 x 0.7 (0.28 x 0.28)	7.0 to 15.5 (2.76 to 6.10)
	0.38 (15)	1.1 x 1.1 (0.43 x 0.43)	4.5 to 21.0 (1.77 to 8.27)
DataMatrix	0.19 (7.5)	0.8 x 0.8 (0.31 x 0.31)	9.0 to 13.0 (3.54 to 5.12)
	0.25 (10)	0.8 x 0.8 (0.31 x 0.31)	7.5 to 16.5 (2.95 to 6.50)
	0.38 (15)	1.0 x 1.0 (0.39 x 0.39)	6.0 to 22.0 (2.36 to 8.66)
Sensor	640 x 480 pixel element, 2D CMOS array		
Illuminator	LED array		
Wavelength	630~670 nm		
LED Safety class	Class 1 to EN 60825-1		
Aiming System	Visible Laser Diode		
Wavelength	650 nm		
Laser Safety Class	Class 2 EN 60825-1; Class II CDRH		

*Reading distances are measured from the nose of the reader.

5.2 READING DIAGRAMMS

Datalogic Jet™ HP Laser (XXX-1XX-XXX models)

Reading Zones (10° skew angle)

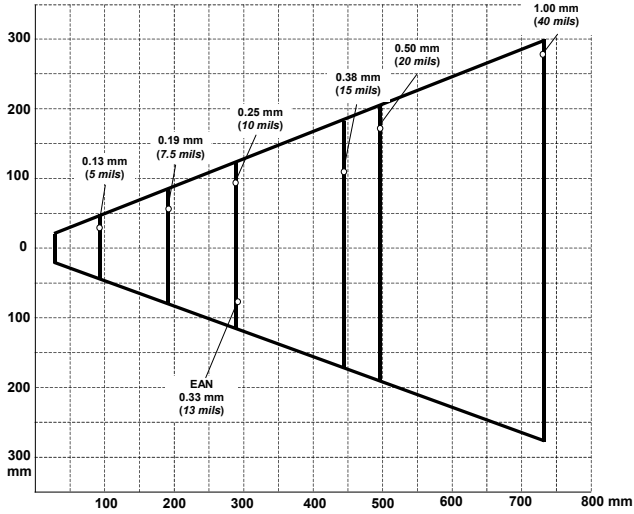

Datalogic Jet™ RFID +Laser (XXX-4XX-XXX models)

Reading Zones (10° skew angle)

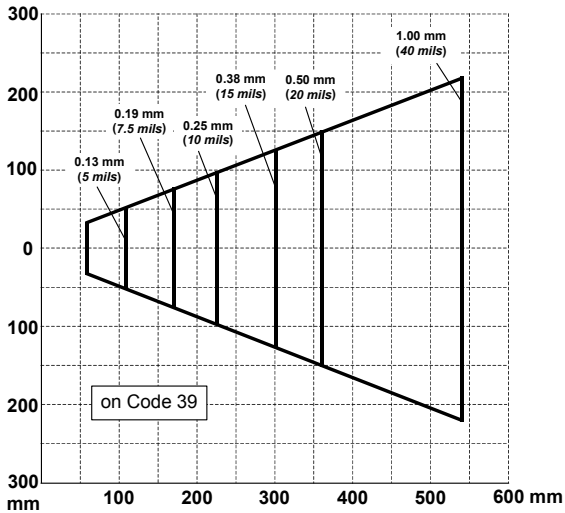

6 TEST CODES

High Density Codes

0.25 mm (10 mils)

Code 39



17162

2/5 Interleaved



0123456784

Code 128



test

EAN 13



8 012345 000012

EAN 8



6450 9723

Medium Density Codes

0.38 mm (15 mils)

Code 39



17162

Interleaved 2/5



0123456784

Code 128



test

EAN 13



8 012345 000012

EAN 8

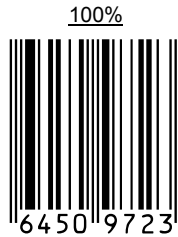

6450 9723

Low Density Codes

0.50 mm (20 mils)

Code 39



17162

Interleaved 2/5



0123456784

Code 128



test

EAN 13

120%



8 012345 000012

EAN 8

120%



6450 9723

GLOSSARY

Access Point

A device that provides transparent access between Ethernet wired networks and IEEE 802.11 interoperable radio-equipped mobile units. Hand-held terminals, PDAs or other devices equipped with radio cards, communicate with wired networks using Access Points (AP). The mobile unit (PDA), may roam among the APs in the same subnet while maintaining a continuous, seamless connection to the wired network.

Barcode

A pattern of variable-width bars and spaces which represents numeric or alphanumeric data in binary form. The general format of a barcode symbol consists of a leading margin, start character, data or message character, check character (if any), stop character, and trailing margin. Within this framework, each recognizable symbology uses its own unique format.

Baud Rate

A measure for data transmission speed.

Bit

Binary digit. One bit is the basic unit of binary information. Generally, eight consecutive bits compose one byte of data. The pattern of 0 and 1 values within the byte determines its meaning.

Bits per Second (bps)

Number of bits transmitted or received per second.

Bluetooth®

A standard radio technology using a proprietary protocol. The onboard Bluetooth module in the PDA is compatible with the 1.2 protocol.

Byte

On an addressable boundary, eight adjacent binary digits (0 and 1) combined in a pattern to represent a specific character or numeric value. Bits are numbered from the right, 0 through 7, with bit 0 the low-order bit. One byte in memory can be used to store one ASCII character.

Decode

To recognize a bar code symbology (e.g., Codabar, Code 128, Code 3 of 9, UPC/EAN, etc.) and analyze the content of the bar code scanned.

EEPROM

Electrically Erasable Programmable Read-Only Memory. An on-board non-volatile memory chip.

Flash Disk

Non-volatile memory for storing application and configuration files.

GSM

Global System for Mobile communication. It is a standard for digital cellular communications, currently used in the 900 MHz and 1800 MHz bands.

GPRS

General Packet Radio Service. GPRS is a wireless packet-based communication service based on GSM. Its data transfer is rated between 56 Kbps to 114 Kbps. It makes very efficient use of available radio spectrum, and users pay only for the volume of data sent and received.

Host

A computer that serves other terminals in a network, providing services such as network control, database access, special programs, supervisory programs, or programming languages.

Liquid Crystal Display (LCD)

A display that uses liquid crystal sealed between two glass plates. The crystals are excited by precise electrical charges, causing them to reflect light outside according to their bias. They use little electricity and react relatively quickly. They require external light to reflect their information to the user.

Light Emitting Diode (LED)

A low power electronic light source commonly used as an indicator light. It uses less power than an incandescent light bulb but more than a Liquid Crystal Display (LCD).

PDA

Personal Digital Assistant. PDA is a term for any small mobile hand-held device that provides computing and information storage and retrieval capabilities for personal or business use, often for keeping schedule calendars and address book information handy.

RAM

Random Access Memory. Data in RAM can be accessed in random order, and quickly written and read.

RF

Radio Frequency.

RFID (Radio frequency identification)

A technology that incorporates the use of electromagnetic or electrostatic coupling in the radio frequency (RF) portion of the electromagnetic spectrum to uniquely identify an object, animal, or person. RFID is coming into increasing use in industry as an alternative to the barcode identification.

RTC

Real Time Clock.

INDEX

A

Accessories; 4
Available Models; 2

B

Backup Directory File Management;
40
Bluetooth Approval; viii
Bluetooth® Manager Device Setup;
37
Buttons; 28

C

Charging the Batteries; 41
Cleaning the PDA; 43
Connection Cables; 11
 RS232 Direct Connection; 11
 USB Direct Connection; 11
Connections; 5
 RS232/USB Direct Connection; 5
 WLAN Connection; 6
 WPAN Connection; 7
 WWAN Connection; 8
Control Panel; 27
Conventions; vii

D

Data Capture; 14
 Imager Data Capture; 15
 Laser Data Capture; 14
 RFID Data Capture; 16
Data Capture Configuration; 22
Datalogic Jet™ PDA Description; 1
Default Settings; 25
Description of the Keys; 17

E

End User License Agreement; v

F

Files Admin; 29

G

General View; xv
Glossary; 51

K

Key Selection; 18

M

Maintenance; 41
Microsoft® ActiveSync®; 35

P

Package Contents; 2
PDA Startup; 12

R

Reader Parameters; 24
Reading Diagrams; 47
Reference Documentation; vii
References; vii
Registry; 28
Replacing the Batteries; 42

S

Safe Setup; 29
Safety Regulations; viii
 FCC Compliance; xiv
 Laser Safety; ix
 Radio Compliance; xiii
 SAR Compliance; xiv
 WEEE Compliance; xiv
Save Session; 29
Scan Parameters; 24
Services and Support; vii

SIM Card; 9
Status Indicators; 20
System Control and Navigation Keys;
17

T

Technical Features; 44
Test Codes; 48

U

Using the Stylus; 13

V

Vocal Communication; 32
Volume Settings; 32

W

Wireless Communication; 31

dichiara che
declares that the
déclare que le
bescheinigt, daß das Gerät
declare que el

Datalogic JET XXX-XXX-XXX

e tutti i suoi modelli
and all its models
et tous ses modèles
und seine modelle
y todos sus modelos

sono conformi alla Direttiva del Consiglio Europeo sottoelencata:
are in conformity with the requirements of the European Council Directive listed below:
sont conformes aux spécifications de la Directive de l'Union Européenne ci-dessous:
der nachstehenden angeführten Direktive des Europäischen Rats entsprechen:
cumple con los requisitos de la Directiva del Consejo Europeo, según la lista siguiente:

1999/5/EEC R&TTE

Questa dichiarazione è basata sulla conformità dei prodotti alle norme seguenti:
This declaration is based upon compliance of the products to the following standards:
Cette déclaration repose sur la conformité des produits aux normes suivantes:
Diese Erklärung basiert darauf, daß das Produkt den folgenden Normen entspricht:
Esta declaración se basa en el cumplimiento de los productos con las siguientes normas:

- ETSI EN 301 489-3 v1.4.1, August 2002:** ELECTROMAGNETIC COMPATIBILITY AND RADIO SPECTRUM MATTERS (ERM); ELECTROMAGNETIC COMPATIBILITY (EMC) STANDARD FOR RADIO EQUIPMENT AND SERVICES; PART 3: SPECIFIC CONDITIONS FOR SHORT-RANGE DEVICES (SRD) OPERATING ON FREQUENCIES BETWEEN 9KHZ AND 40 GHZ
- ETSI EN 301 489-7 v1.2.1, August 2002:** ELECTROMAGNETIC COMPATIBILITY AND RADIO SPECTRUM MATTERS (ERM); ELECTROMAGNETIC COMPATIBILITY (EMC) CONDITIONS FOR MOBILE AND PORTABLE RADIO AND ANCILLARY EQUIPMENT OF DIGITAL CELLULAR RADIO TELECOMMUNICATIONS SYSTEMS (GSM AND DCS) OPERATING ON FREQUENCIES BETWEEN 9KHZ AND 40GHZ
- ETSI EN 301 489-17 v1.2.1, August 2002:** ELECTROMAGNETIC COMPATIBILITY AND RADIO SPECTRUM MATTERS (ERM); ELECTROMAGNETIC COMPATIBILITY (EMC) STANDARD FOR RADIO EQUIPMENT AND SERVICES; PART 17: SPECIFIC CONDITIONS FOR 2,4GHZ WIDEBAND TRANSMISSION SYSTEMS AND 5GHZ HIGH PERFORMANCE RLAN EQUIPMENT
- ETSI EN 301 511, March 2003:** GLOBAL SYSTEM FOR MOBILE COMMUNICATIONS (GSM); HARMONIZED EN FOR MOBILE STATIONS IN THE GSM 900 AND GSM 1800 BANDS COVERING ESSENTIAL REQUIREMENT UNDER ARTICLE 3.2 OF THE R&TTE DIRECTIVE (1999/5/EC)

- ETSI EN 300 328 v1.6.1, November 2004:** ELECTROMAGNETIC COMPATIBILITY AND RADIO SPECTRUM MATTERS (ERM); WIDEBAND TRANSMISSION SYSTEMS; DATA TRANSMISSION EQUIPMENT OPERATING IN THE 2,4 GHz ISM BAND AND USING WIDE BAND MODULATION TECHNIQUES; HARMONIZED EN COVERING ESSENTIAL REQUIREMENTS UNDER ARTICLE 3.2 OF THE R & TTE DIRECTIVE
- ETSI EN 300 330-2 v1.1.1, June 2001:** ELECTROMAGNETIC COMPATIBILITY AND RADIO SPECTRUM MATTERS (ERM); SHORT RANGE DEVICES (SRD); RADIO EQUIPMENT IN THE FREQUENCY RANGE 9 KHz TO 25 MHz AND INDUCTIVE LOOP SYSTEMS IN THE FREQUENCY RANGE 9 KHz TO 30 MHz; PART 2: HARMONIZED EN UNDER ARTICLE 3.2 OF THE R&TTE DIRECTIVE
- EN 60950-1, December 2001:** INFORMATION TECHNOLOGY EQUIPMENT – SAFETY – PART 1: GENERAL REQUIREMENTS
- EN 50360, November 2001:** PRODUCT STANDARD TO DEMONSTRATE THE COMPLIANCE OF MOBILE PHONES WITH THE BASIC RESTRICTIONS RELATED TO HUMAN EXPOSURE TO ELECTROMAGNETIC FIELDS (300 MHz – 3 GHz)

Lippo di Calderara, 20/09/2006

Ruggero Cacioppo
Quality Assurance Laboratory Manager