

PHILIPS

Product Overview

XI040C110V054BPT1	
Brand Name	XITANIUM
Description	XITANIUM 40W 0.1-1.1A 54V 0-10V w/t SimpleSet
Input Voltage	120 ~ 277V
Input Freq.	50/60Hz
RoHS	Yes
Status	Preliminary

Input Voltage (Vac)	Output Power (W)	Output Voltage Range (V)	Output Current (A)	Efficiency@ Max Load and 70°C Case	Max Case Temp. (°C)	Input Current (Arms)	Max. Input Power (W)	Inrush Current (Apk/50%-µs)	THD @ Max Load (%)	Power Factor @ Max Load	Surge Protection (Ring wave, KV)	Weight (Lbs/kgs)	Envir. Protection Rating
120	40	27 - 54	0.1 – 1.1	85	Life – 75°C	0.4	47	TBD	<10%	>0.95	>2.5	0.697/0.316	UL damp and dry
277				87		0.17		TBD	<15%				

Wire Diagram

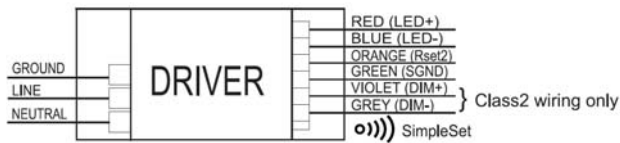

Product Data:

Driver case must be grounded.

Install in accordance with National and Local Electrical Codes.

Use 18 AWG solid copper wire rated $\geq 300V/85^{\circ}C$.

Strip wire 3/8".

Dimming	Dimming Range	Minimum Output Current (A)	Other Comments
0-10V Class 2 Wiring	5% ~ 100% (for output current range 0.25-1.1A)	0.0125	Dimming source current: 150 µA

Enclosure



	In	mm
Case Length	14.17	360
Case Width	1.18	30
Case Height	1.0	25
Mount length	13.78	350
Overall Length		

Revised 6/27/2014

PHILIPS LIGHTING ELECTRONICS N.A.

10275 WEST HIGGINS ROAD · ROSEMONT, IL 60018

Tel: 800-322-2086 · Fax: 888-423-1882 · www.philips.com/advance

Customer Support/Technical Service: 800-372-3331 · OEM Support: 866-915-5886



Electrical Specifications

All the specifications are typical and at 25°C Tcase unless specified otherwise.

XI040C110V054BPT1	
Brand Name	XITANIUM
Description	XITANIUM 40W 0.1-1.1A 54V 0-10V w/t SimpleSet
Input Voltage	120 ~ 277V
Input Freq.	50/60Hz
RoHS	Yes
Status	Preliminary

Order code	XI040C110V054BPT1
Full product code	XI040C110V054BPT1M (Mid-Pack, 18pcs/box)
Full product name	XITANIUM 54W 0.1-1.1A 54V 0-10V INT-T
Line Voltage	120-277Vac_rms
Line Current	0.40A @ 120V, 0.17A @ 277V
Line Frequency	50/60Hz
Min. Mains voltage operational	108 V [min]
Max. Mains voltage operational	305V [max]
THD (total)	Refer to graph
Power Factor (PF)	Refer to graph
Inrush Current	Per NEMA 410
Lightning Surge Protection	Refer to table below
Output voltage range	27V to 54Vdc
Maximum open circuit voltage	60V
Output Current Ripple (ripple = peak to peak / average)	15% max @ max lout Low frequency (≤ 120 Hz) content <TBD%
Protections	Short Circuit and Open Circuit Protection for LED + and LED-, mis-wiring protection
Ambient Temp Range	-20C to +50C
Max Case Temperature (Tcase)	75°C for Life
Interfaces	0-10V Dimming, AOC
AOC (Adjustable Output Current)	100mA to 1100mA via external resistor or SimpleSet programming (refer to graph and notes below)
0-10V Dimming Specifications	150 μ A source current from driver, See dim curve for detail.
Environmental Protection Rating	UL damp and dry
Agency Approbations	UL8750, UL1310, UL935, CSA-C22.2 No. 250.13-12, CSA C22.2 No. 223
Electromagnetic Compliance	FCC Title 47 Part 15 Class A
Isolation	Refer to table
Audible noise	<24dB Class A

Revised 6/27/2014

PHILIPS LIGHTING ELECTRONICS N.A.
10275 WEST HIGGINS ROAD · ROSEMONT, IL 60018
Tel: 800-322-2086 · Fax: 888-423-1882 · www.philips.com/advance
Customer Support/Technical Service: 800-372-3331 · OEM Support: 866-915-5886

PHILIPS

Electrical Specifications

All the specifications are typical and at 25°C Tcase unless specified otherwise.

XI040C110V054BPT1	
Brand Name	XITANIUM
Description	XITANIUM 40W 0.1-1.1A 54V 0-10V w/t SimpleSet
Input Voltage	120 ~ 277V
Input Freq.	50/60Hz
RoHS	Yes
Status	Preliminary

0-10V Dimming Curve:

Dimming source current from the driver: 150µA (@ 0<Vdim<8V)

LED Current Tolerance at 1100mA ≤ 5% over temperature and component variations

Minimum Dim Level: 5% of Iout (minimum 12.5mA)

Maximum output voltage on the dimming wires: 12V

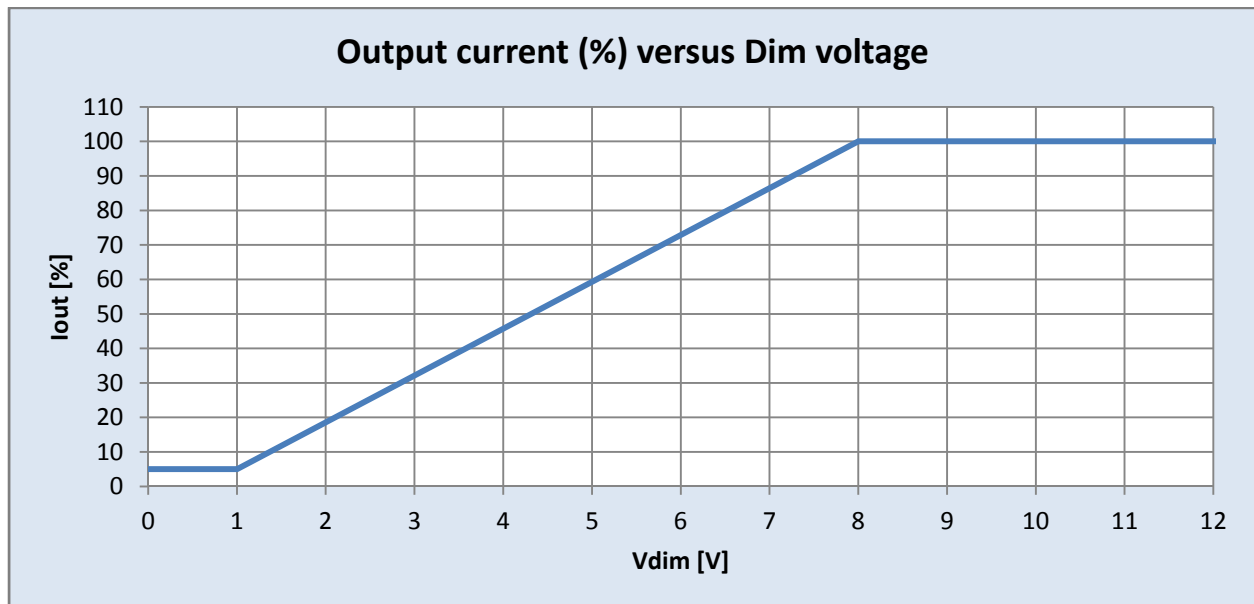

Approved Dimmer List

Manufacturer	Manufacturer Part Number
Lutron	Visit www.lutron.com/advance for a list of dimmers (Mark VII) that will work with this driver
Leviton	IllumaTech IP7 series
Philips	Sunrise - SR I200ZTUNV

For compatibility with other dimmers please contact the dimmer manufacturer

Revised 6/27/2014

PHILIPS LIGHTING ELECTRONICS N.A.
 10275 WEST HIGGINS ROAD · ROSEMONT, IL 60018
 Tel: 800-322-2086 · Fax: 888-423-1882 · www.philips.com/advance
 Customer Support/Technical Service: 800-372-3331 · OEM Support: 866-915-5886



Electrical Specifications

All the specifications are typical and at 25°C Tcase unless specified otherwise.

XI040C110V054BPT1	
Brand Name	XITANIUM
Description	XITANIUM 40W 0.1-1.1A 54V 0-10V w/t SimpleSet
Input Voltage	120 ~ 277V
Input Freq.	50/60Hz
RoHS	Yes
Status	Preliminary

AOC (Adjustable Output Current) Settings:

LED Current Tolerance over temperature and component variations for AOC ≤ 10% at any level.

Rset (Ohms)	Current (mA)	Rset (Ohms)	Current (mA)
1	100	1800	684
100	100	2000	733
110	106	2200	780
120	111	2400	823
130	116	2700	883
150	125	3000	941
160	130	3300	993
180	138	3600	1042
200	146	3900	1085
220	155	4300	1100
240	166	4700	1100
270	176	>100000	1100
300	190		
330	204		
360	215		
390	228		
430	245		
470	261		
510	277		
560	300		
620	318		
680	340		
750	368		
820	392		
910	422		
1000	452		
1100	485		
1200	515		
1300	545		
1500	602		
1600	632		

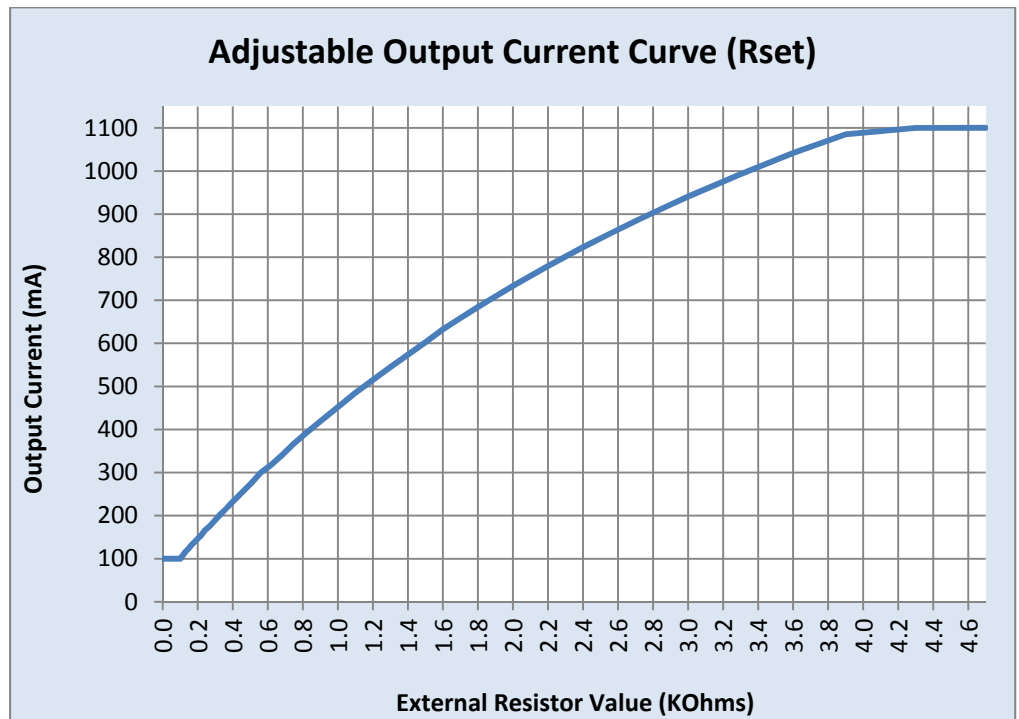

Notes:

1. There are two ways to adjust the current
 - a. Using a resistor between Rset2 & SGND leads
 - i. Any through hole or SMD resistor with >0.25W and >20V can be used as RSET between Rset and SGND pins.
 - ii. Driver will default to 1100mA when Rset is left open.
 - b. Using SimpleSet programming (visit www.philips.com/simpleset for details)
2. The driver is by default set to Rset2

Revised 6/27/2014

PHILIPS LIGHTING ELECTRONICS N.A.

10275 WEST HIGGINS ROAD · ROSEMONT, IL 60018

Tel: 800-322-2086 · Fax: 888-423-1882 · www.philips.com/advance

Customer Support/Technical Service: 800-372-3331 · OEM Support: 866-915-5886

PHILIPS

Electrical Specifications

All the specifications are typical and at 25°C Tcase unless specified otherwise.

XI040C110V054BPT1	
Brand Name	XITANIUM
Description	XITANIUM 40W 0.1-1.1A 54V 0-10V w/t SimpleSet
Input Voltage	120 ~ 277V
Input Freq.	50/60Hz
RoHS	Yes
Status	Preliminary

Operating Window:

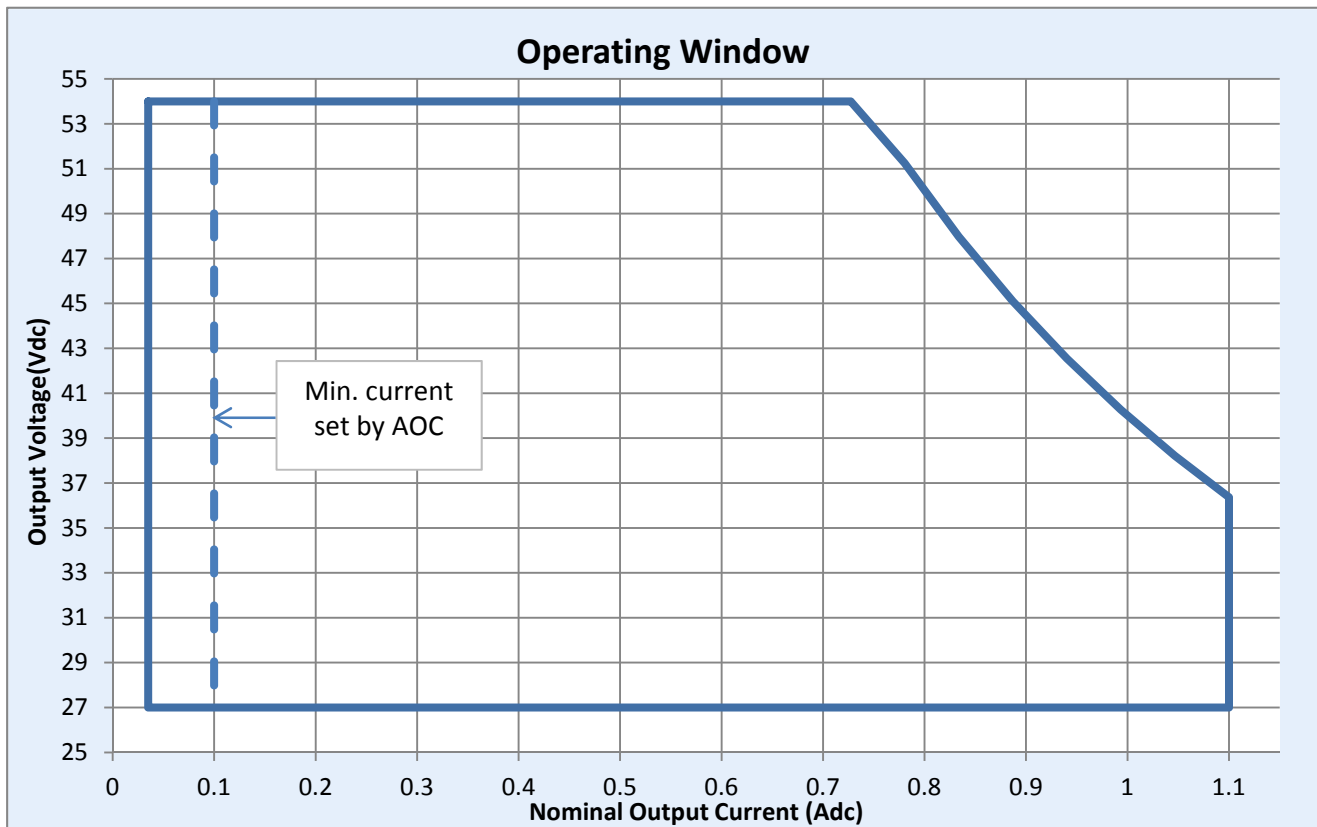

Note: For 5% dimming output current setting through AOC should be >0.25A

Revised 6/27/2014

PHILIPS LIGHTING ELECTRONICS N.A.
10275 WEST HIGGINS ROAD · ROSEMONT, IL 60018
Tel: 800-322-2086 · Fax: 888-423-1882 · www.philips.com/advance
Customer Support/Technical Service: 800-372-3331 · OEM Support: 866-915-5886

PHILIPS

Electrical Specifications

All the specifications are typical and at 25°C Tcase unless specified otherwise.

XI040C110V054BPT1

Brand Name	XITANIUM
Description	XITANIUM 40W 0.1-1.1A 54V 0-10V w/t SimpleSet
Input Voltage	120 ~ 277V
Input Freq.	50/60Hz
RoHS	Yes
Status	Preliminary

Inrush Current Info:

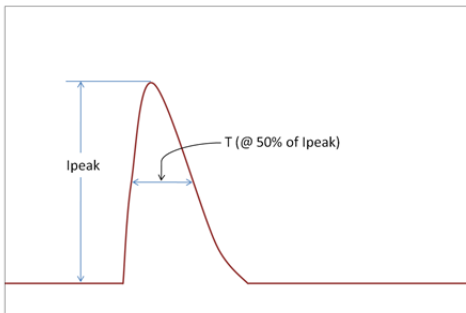

Vin	Ipeak	T (@ 50% of Ipeak)
120 Vrms	TBD	TBD
277 Vrms	TBD	TBD

Inrush current is measured at peak of the corresponding line voltage, source impedance per NEMA 410.

Lightning Surge Info:

ANSI Surge Type	Differential Mode (L-N)	Common Mode (L-G, N-G, L&N-G)
100 kHz Ring Wave (w/t 30Ω)	>2.5kV	>2.5kV

Revised 6/27/2014

PHILIPS LIGHTING ELECTRONICS N.A.
 10275 WEST HIGGINS ROAD · ROSEMONT, IL 60018
 Tel: 800-322-2086 · Fax: 888-423-1882 · www.philips.com/advance
 Customer Support/Technical Service: 800-372-3331 · OEM Support: 866-915-5886

PHILIPS

Mechanical Specifications

XI040C110V054BPT1	
Brand Name	XITANIUM
Description	XITANIUM 40W 0.1-1.1A 54V 0-10V w/t SimpleSet
Input Voltage	120 ~ 277V
Input Freq.	50/60Hz
RoHS	Yes
Status	Preliminary

Mechanical Drawing:

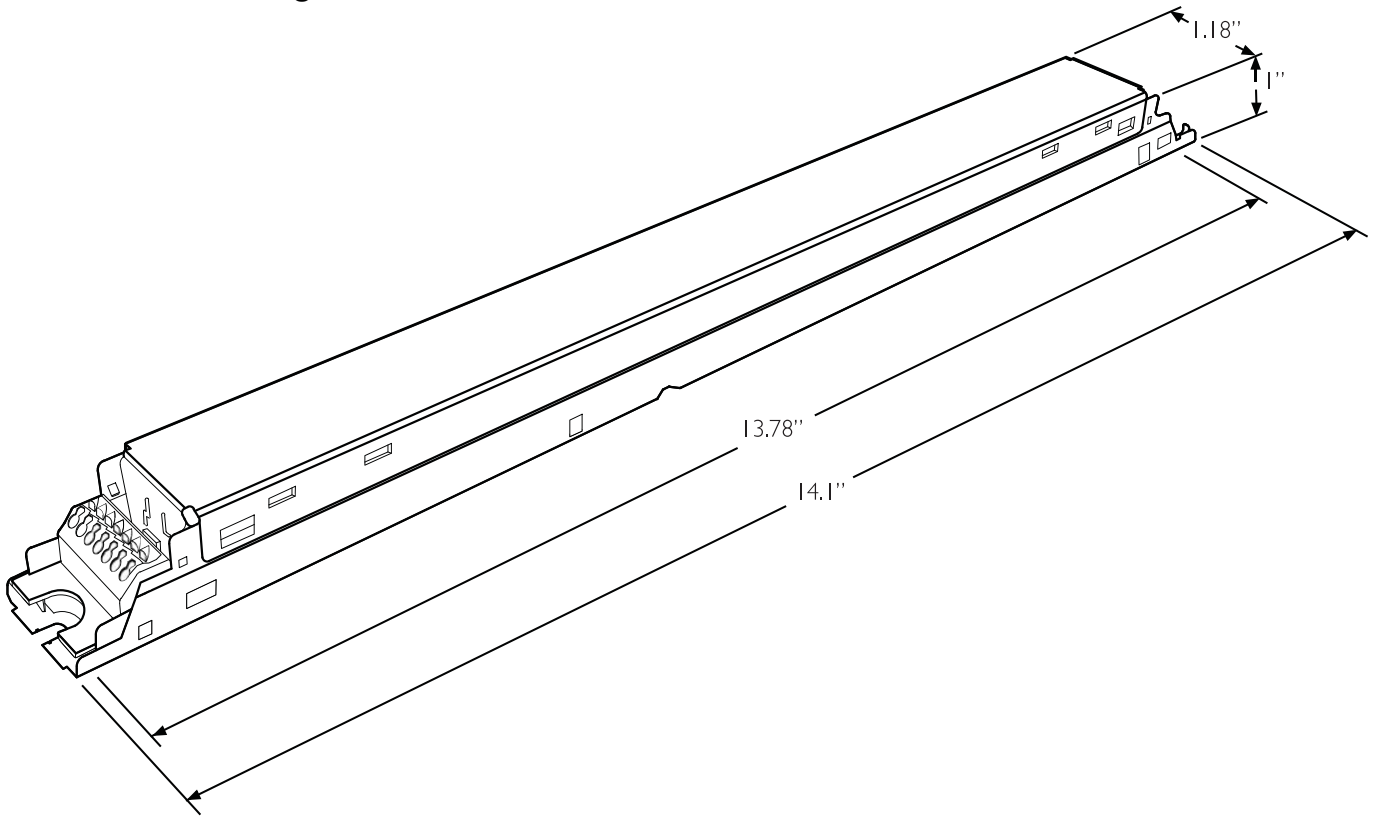

T-360

Revised 6/27/2014

PHILIPS LIGHTING ELECTRONICS N.A.
10275 WEST HIGGINS ROAD · ROSEMONT, IL 60018
Tel: 800-322-2086 · Fax: 888-423-1882 · www.philips.com/advance
Customer Support/Technical Service: 800-372-3331 · OEM Support: 866-915-5886



Performance Characteristics

Based on measurements on a typical sample. The accuracy of the measurements is within the tolerance of the measurement instruments. The graphs are meant to be a guideline and not a specification.

XI040C110V054BPT1	
Brand Name	XITANIUM
Description	XITANIUM 40W 0.1-1.1A 54V 0-10V w/t SimpleSet
Input Voltage	120 ~ 277V
Input Freq.	50/60Hz
RoHS	Yes
Status	Preliminary

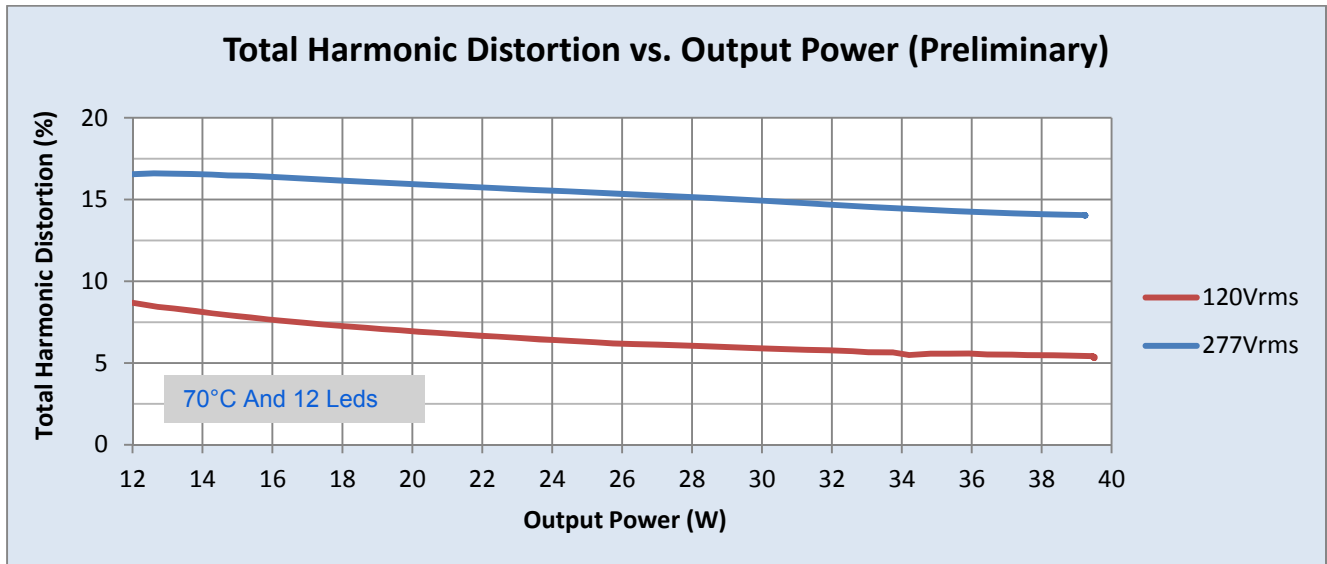
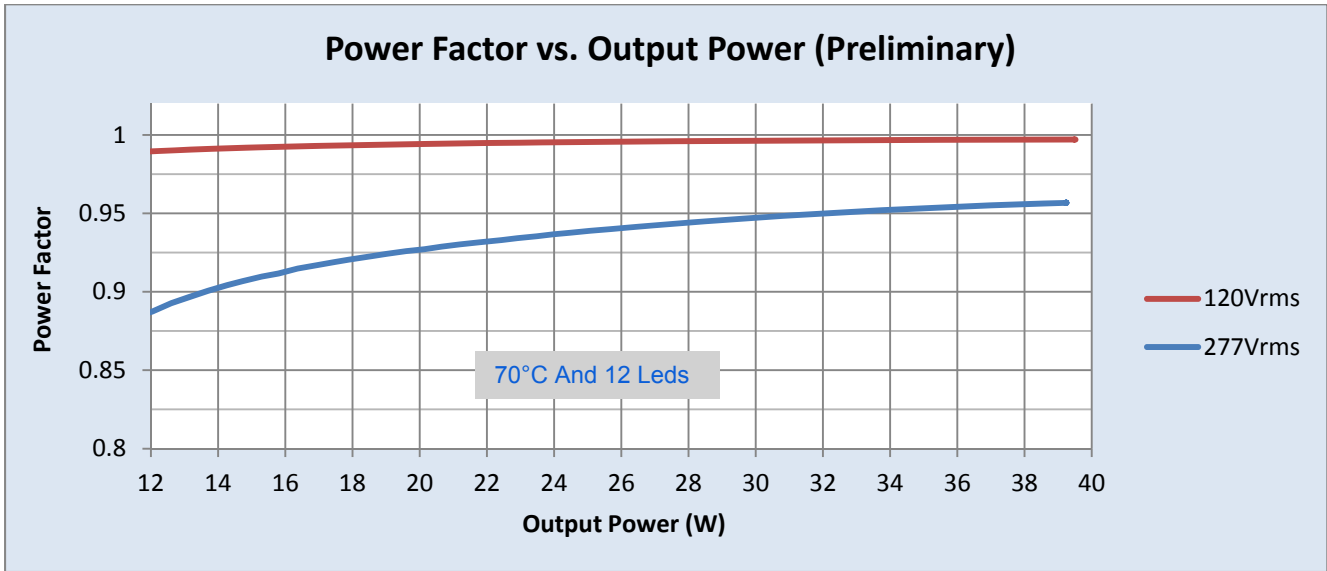

Revised 6/27/2014



Application Notes:

XI040C110V054BPT1	
Brand Name	XITANIUM
Description	XITANIUM 40W 0.1-1.1A 54V 0-10V w/t SimpleSet
Input Voltage	120 ~ 277V
Input Freq.	50/60Hz
RoHS	Yes
Status	Preliminary

Isolation:

Isolation	Input	Output	0-10V (Class 2)	Enclosure
Input	Not applicable	2xU+1KV	2.5KVac	2xU+1KV
Output	2xU+1KV	Not applicable	Non-isolated	500V
0-10V (Class 2)	2.5KVac	Non-isolated	Not applicable	500V
Enclosure	2xU+1KV	500V	500V	Not applicable

UL Conditions of Acceptability:

Please contact your Philips representative for a copy of the latest UL Conditions Of Acceptability (COA).

Revised 6/27/2014

PHILIPS LIGHTING ELECTRONICS N.A.
10275 WEST HIGGINS ROAD · ROSEMONT, IL 60018
Tel: 800-322-2086 · Fax: 888-423-1882 · www.philips.com/advance
Customer Support/Technical Service: 800-372-3331 · OEM Support: 866-915-5886