

**AC1200 Wireless LAN 11ac
Dual-Band Concurrent
Wall Mount Access Point**

User's Manual

**Version: 1.0
(October, 2014)**

CONTENTS

I. Product Information.....	1
I-1. Package Contents	1
I-2. System Requirements.....	2
I-3. Hardware Overview	2
I-4. LED Status	3
I-5. Reset	3
I-6. Magnetic Wall Mount.....	4
I-7. Console	5
I-8. Safety Information.....	6
II. Quick Setup.....	7
II-1. Initial Setup.....	7
II-2. Basic Settings	9
II-3. Wi-Fi Protected Setup (WPS).....	13
III. Hardware Installation	13
IV. Browser Based Configuration Interface.....	14
IV-1. Information	17
IV-1-1. System Information	17
IV-1-2. Wireless Clients.....	21
IV-1-3. Wireless Monitor	23
IV-1-4. Log.....	24
IV-2. Network Settings	26
IV-2-1. LAN-Side IP Address.....	26
IV-2-2. LAN Port.....	28
IV-2-3. VLAN	29
IV-3. Wireless Settings.....	30
IV-3-1. 2.4GHz 11bgn.....	30
IV-3-1-1. Basic	31
IV-3-1-2. Advanced	34
IV-3-1-3. Security	36
IV-3-1-3-1. No Authentication	37
IV-3-1-3-2. WEP.....	38
IV-3-1-3-3. IEEE802.1x/EAP.....	38
IV-3-1-3-4. WPA-PSK	38
IV-3-1-3-5. WPA-EAP.....	39
IV-3-1-3-6. Additional Authentication	39
IV-3-1-4. WDS	41

IV-3-2.	5GHz 11ac 11an	43
IV-3-2-1.	Basic	43
IV-3-2-2.	Advanced	46
IV-3-2-3.	Security	48
IV-3-2-4.	WDS	50
IV-3-3.	RADIUS	52
IV-3-3-1.	RADIUS Settings	53
IV-3-3-2.	Internal Server	54
IV-3-3-3.	RADIUS Accounts	56
IV-3-4.	MAC Filter	58
IV-3-5.	WMM	60
IV-4.	Management	62
IV-4-1.	Admin.....	62
IV-4-2.	Date and Time.....	65
IV-4-3.	Syslog Server	67
IV-4-4.	I'm Here	68
IV-5.	Advanced	69
IV-5-1.	LED Settings	69
IV-5-2.	Update Firmware	70
IV-5-3.	Save/Restore Settings.....	72
IV-5-4.	Factory Default	75
IV-5-5.	Reboot	76

V. Appendix77

V-1.	Configuring your IP address.....	78
V-1-1.	Windows XP	78
V-1-2.	Windows Vista	80
V-1-3.	Windows 7	82
V-1-4.	Windows 8	89
V-1-5.	Mac	89
V-1-6.	Glossary.....	91
V-2.	Hardware Specification.....	94
V-3.	ENVIRONMENT & PHYSICAL	94

I. Product Information

I-1. Package Contents

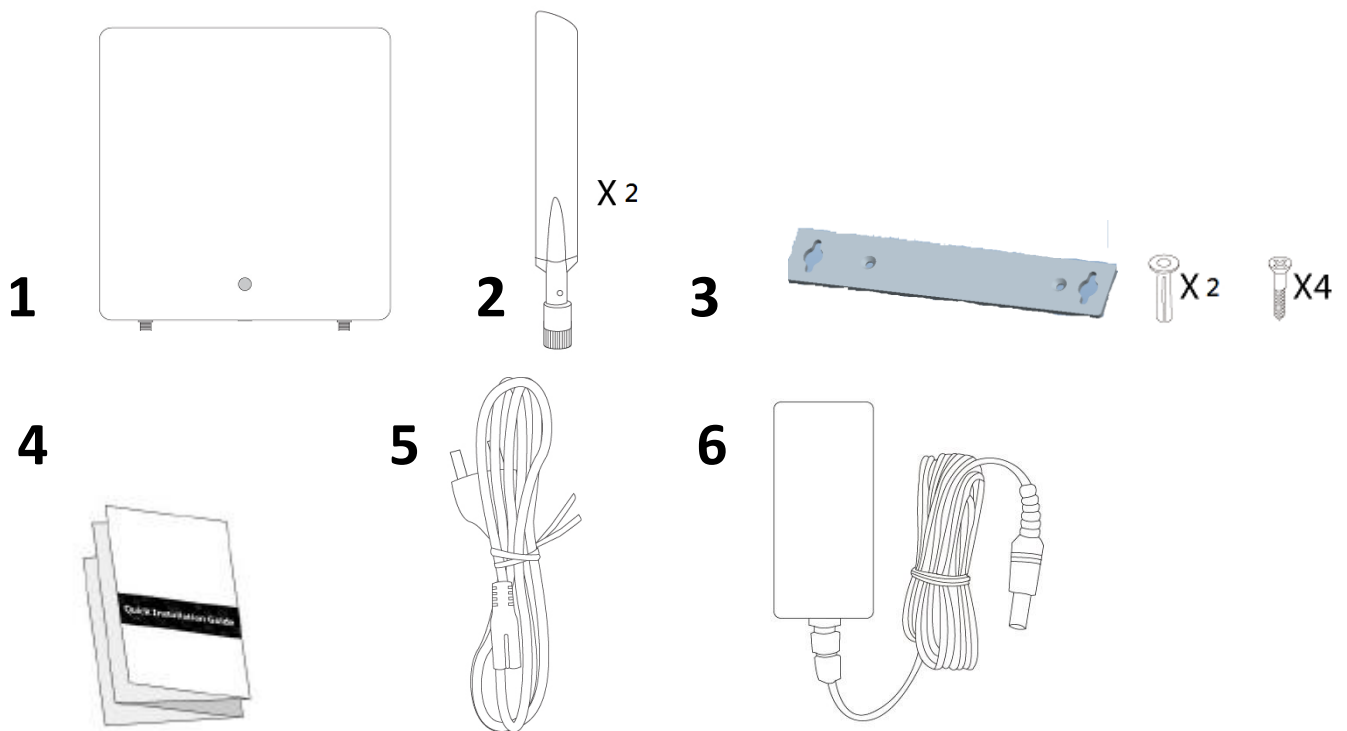

1. Access Point

2. Antennas x 2

3. Magnetic Wall Mount x 1

& Screws

4. Quick Installation Guide

5. Power Cord

6. Power Adapter

I-2. System Requirements

- Existing cable/DSL modem & router
- Computer with web browser for access point configuration

I-3. Hardware Overview

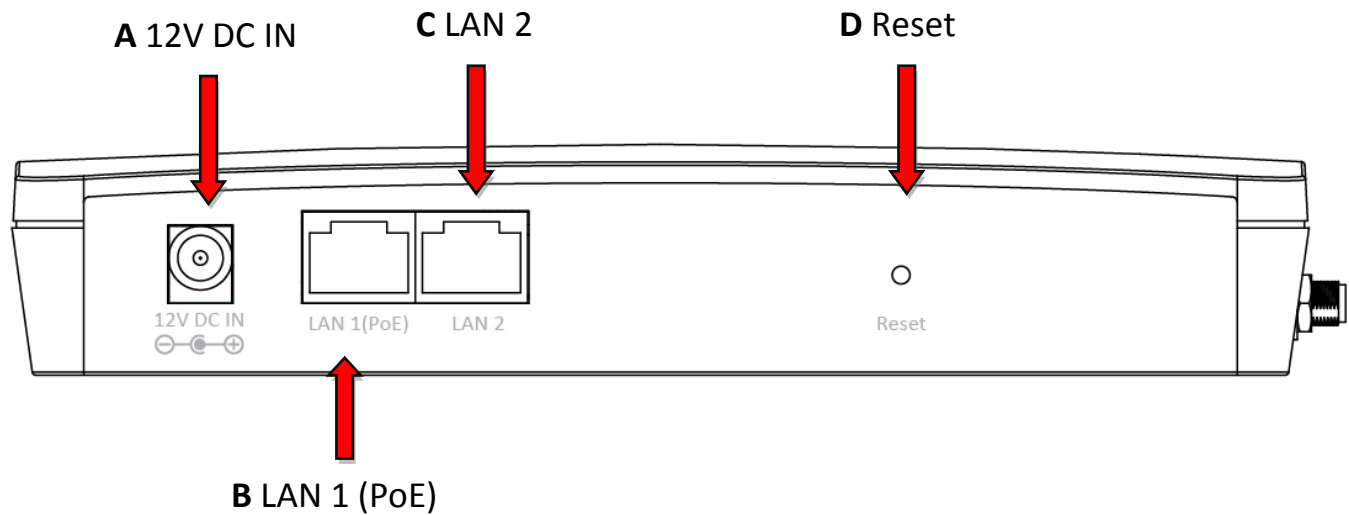

- A.** 12V DC port to connect the power adapter
- B.** LAN port with Power over Ethernet (PoE PD, IN)
- C.** LAN port with Power over Ethernet (PoE PSE, OUT)
- D.** Reset the access point to factory default settings

I-4. LED Status

LED Status	Description
Off	The access point is off.
Blue	The access point is on.
Amber	The access point is starting up.

I-5. Reset

If you experience problems with your access point, you can reset the device back to its factory settings. This resets **all** settings back to default.

1. Press and hold the reset button on the access point for at least 10 seconds than release the button.



You may need to use a pin or similar sharp object to push the reset button.

2. Wait for the access point to restart. The access point is ready for setup when the LED is **blue**.

I-6. Magnetic Wall Mount

The access point includes a magnetic wall mount which requires some assembly.

1. Attach the two magnetic wall mount strips to your wall using the included screws, as shown below.

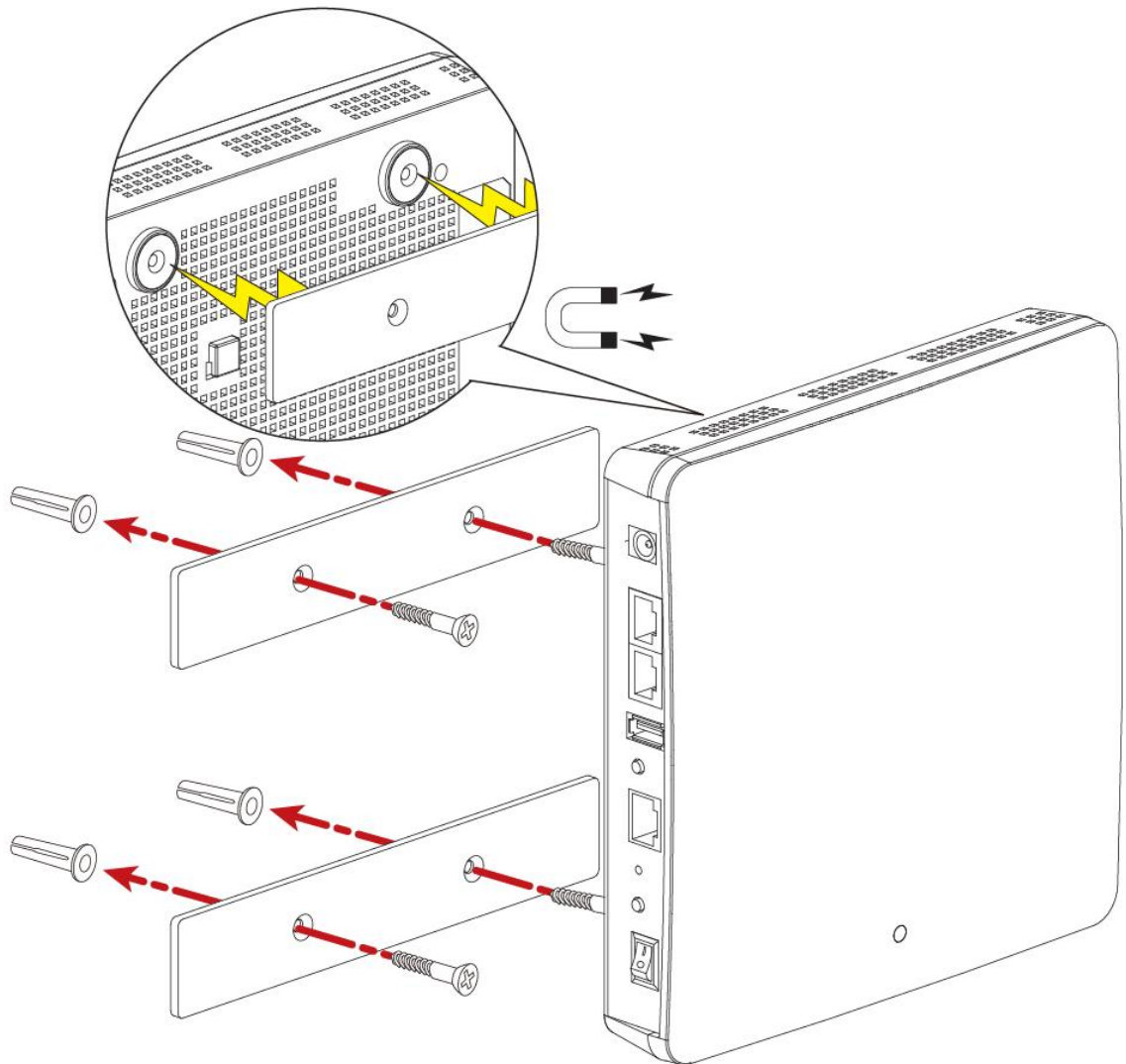

2. Press the back of your access point firmly against the two wall mounted magnetic strips, with the access point's in the correct position, upright orientation as displayed above.



Ensure your access point is securely attached to the magnetic strips.

I-7. Console

The access point can be configured via the “Console” port located on the access point’s side panel using a terminal-emulation program (e.g. HyperTerminal).

Use the following configuration settings for terminal-emulation programs:

Baud Rate	115200
Data	8 bit
Parity	None
Stop	1 bit
Flow Control	None

I-8. Safety Information

In order to ensure the safe operation of the device and its users, please read and act in accordance with the following safety instructions.

1. The access point is designed for indoor use only; do not place the access point outdoors.
2. Do not place the access point in or near hot/humid places, such as a kitchen or bathroom.
3. Do not pull any connected cable with force; carefully disconnect it from the access point.
4. Handle the access point with care. Accidental damage will void the warranty of the access point.
5. The device contains small parts which are a danger to small children under 3 years old. Please keep the access point out of reach of children.
6. Do not place the access point on paper, cloth, or other flammable materials. The access point may become hot during use.
7. There are no user-serviceable parts inside the access point. If you experience problems with the access point, please contact your dealer of purchase and ask for help.
8. The access point is an electrical device and as such, if it becomes wet for any reason, do not attempt to touch it without switching the power supply off. Contact an experienced electrical technician for further help.
9. If you smell burning or see smoke coming from the access point or power adapter, then disconnect the access point and power adapter immediately, as far as it is safely possible to do so. Call your dealer of purchase for help.
10. Operating temperature when using power adapter is 0°C to 40°C,
Operating temperature when using PoE switch is 0°C to 50°C.

II. Quick Setup

II-1. Initial Setup

1. Connect the access point to a computer via Ethernet cable.
2. Connect the power adapter to the access point's 12V DC port and plug the power adapter into a power supply using the included cable.

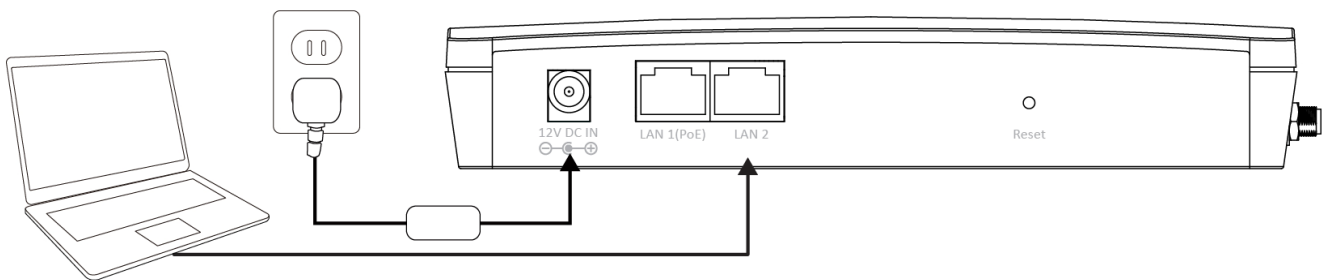

3. Please wait a moment for the access point to start up. The access point is ready when the LED is **blue**.
4. Set your computer's IP address to **192.168.2.x** where **x** is a number in the range **3 – 100**. If you are unsure how to do this, please refer to **V-1. Configuring your IP address** for more information.

 ***Please ensure there are no other active network connections on your computer (disconnect Wi-Fi connections and Ethernet cables).***

5. Enter the access point's default IP address **192.168.2.2** into the URL bar of a web browser.



6. You will be prompted for a username and password. Enter the default username “admin” and the default password “1234”.

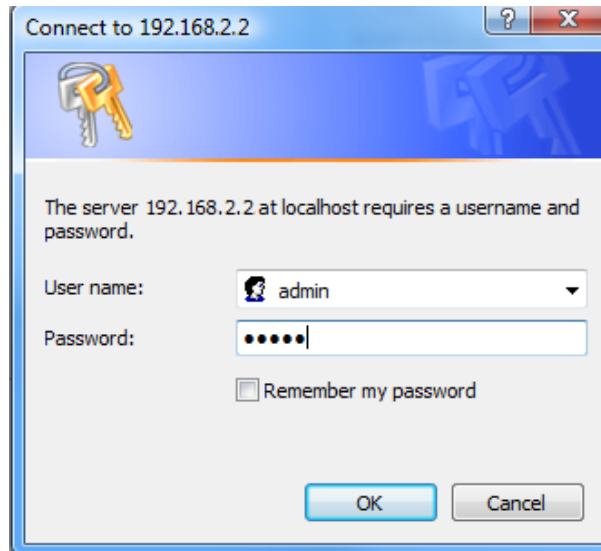

7. You will arrive the “System Information” screen shown below.

System	
Model	Generic-1200
Product Name	AP74DA380B03D4
Uptime	0 day 00:18:51
Boot from	Internal memory
Version	1.0.0
MAC Address	74:DA:38:0B:03:D4
Management VLAN ID	1
IP Address	192.168.2.2 <input type="button" value="Refresh"/>
Default Gateway	---
DNS	---
DHCP Server	---

Wired LAN Port Settings		
Wired LAN Port	Status	VLAN Mode/ID
Wired Port (#1)	Connected (1000 Mbps Full-Duplex)	Untagged Port / 1
Wired Port (#2)	Disconnected (---)	Untagged Port / 1

Wireless 2.4GHz	
Status	Enabled
MAC Address	74:DA:38:0B:03:D4
Channel	Ch 6 (Auto)

8. Next, please follow the instructions below in **II-2. Basic Settings** to configure the access point’s basic settings.



For more advanced configurations, please refer to IV. Browser Based Configuration Interface.

II-2. Basic Settings

The instructions below will help you to configure the following basic settings of the access point:

- **LAN IP Address**
- **2.4GHz & 5GHz SSID & Security**
- **Administrator Name & Password**
- **Time & Date**



It is recommended you configure these settings before using the access point.

- 1.** To change the access point's LAN IP address, go to **“Network Settings” > “LAN-side IP Address”** and you will see the screen below.

LAN-side IP Address	
IP Address Assignment	DHCP Client <input type="button" value="v"/>
IP Address	192.168.2.2
Subnet Mask	255.255.255.0
Default Gateway	From DHCP <input type="button" value="v"/> <input type="text"/>

DNS Servers	
Primary Address	From DHCP <input type="button" value="v"/> <input type="text"/>
Secondary Address	From DHCP <input type="button" value="v"/> <input type="text"/>

- 2.** Enter the IP address settings you wish to use for your access point. You can use a dynamic (DHCP) or static IP address, depending on your network environment. Click **“Apply”** to save the changes and wait a few moments for the access point to reload.



When you change your access point's IP address, you need to use the new IP address to access the browser based configuration interface instead of the default IP 192.168.2.2.

- 3.** To change the SSID of your access point's 2.4GHz wireless network(s), go to **“Wireless Setting” > “2.4GHz 11bgn” > “Basic”**. Enter the new SSID for your 2.4GHz wireless network in the **“SSID1”** field and click **“Apply”**.



To utilize multiple 2.4GHz SSIDs, open the drop down menu labelled “Enable SSID number” and select how many SSIDs you require. Then enter a new SSID in the corresponding numbered fields below, before clicking “Apply”.

2.4GHz Basic Settings

Wireless	<input checked="" type="radio"/> Enable <input type="radio"/> Disable	
Band	11b/g/n ▼	
Enable SSID number	1 ▼	
SSID1	Generic-1200-0B03D4_G	VLAN ID 1
Auto Channel	<input checked="" type="radio"/> Enable <input type="radio"/> Disable	
Auto Channel Range	Ch 1 - 11 ▼	
Auto Channel Interval	One day ▼	
	<input type="checkbox"/> Change channel even if clients are connected	
Channel Bandwidth	Auto ▼	

Security

2.4GHz Wireless Security Settings

SSID	Generic-1200-0B03D4_G ▼
Broadcast SSID	Enable ▼
Wireless Client Isolation	Disable ▼
Load Balancing	50 /50
Authentication Method	No Authentication ▼
Additional Authentication	No additional authentication ▼



Apply Cancel

Apply Cancel

less security”. Select or “Encryption

sing the

2.4GHz Wireless Security Settings

SSID	Generic-1200-0B03D4_G ▼
Broadcast SSID	Enable ▼
Wireless Client Isolation	Disable ▼
Load Balancing	50 /50
Authentication Method	No Authentication ▼
Additional Authentication	No additional authentication ▼

Apply Cancel

- Go to “Wireless Setting” > “5GHz 11ac 11an” and repeat steps 3 & 4 for the access point’s 5GHz wireless network.

6. To change the administrator name and password for the browser based configuration interface, go to **“Management” > “Admin”**.

Account to Manage This Device

Administrator Name	admin
Administrator Password	••••• (4-32 Characters)
	••••• (Confirm)

Apply

7. Complete the **“Administrator Name”** and **“Administrator Password”** fields and click **“Apply”**.

8. To set the correct time for your access point, go to **“Management” > “Date and Time”**.

Date and Time Settings

Local Time

2012	Year	Jan	Month	1	Day
0	Hours	00	Minutes	00	Seconds

Acquire Current Time from Your PC

NTP Time Server

Use NTP	<input type="checkbox"/> Enable
Server Name	
Update Interval	24 hours

Time Zone

Time Zone	(GMT) Greenwich Mean Time: Dublin, Edinburgh, Lisbon, London
-----------	--------------------------------------------------------------

9. Set the correct time and time zone for your access point using the drop down menus. The access point also supports NTP (Network Time Protocol) so alternatively you can enter the host name or IP address of a time server. Click **“Apply”** when you are finished.



You can use the “Acquire Current Time from your PC” button if you wish to set the access point to the same time as your PC.

- 10.** The basic settings of your access point are now configured. Please refer to **III. Hardware Installation** for guidance on connecting your access point to a router or PoE switch.

II-3.

III. Hardware Installation

1. Connect a router or PoE switch to the access point's **LAN 1** port using an Ethernet cable. PoE switches **must** be connected to the access point's **LAN 1** port.

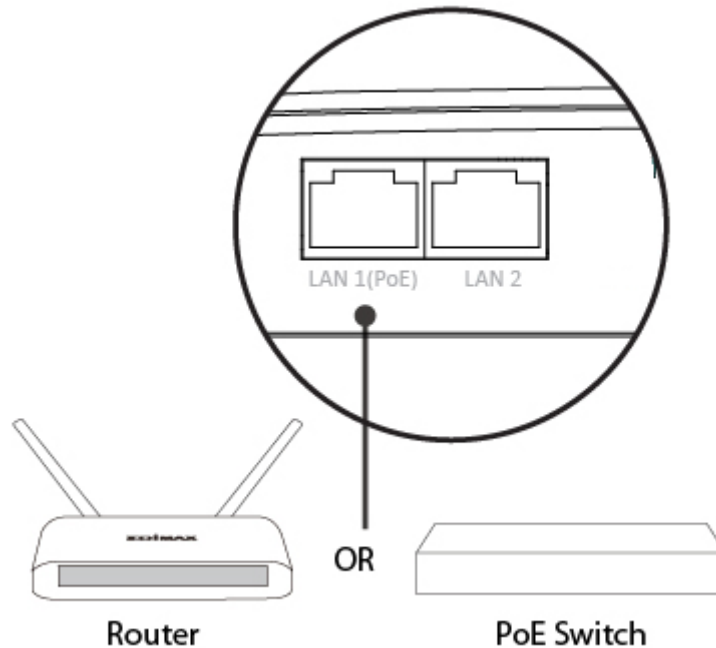

2. If you are using a router, then connect the power adapter to the access point's 12V DC port and plug the power adapter into a power supply.

3. If you are using a PoE (Power over Ethernet) switch then it is not necessary to use the included power adapter, the access point will be powered by the PoE switch.

 **Do not use the power adapter if you are using a PoE switch.**

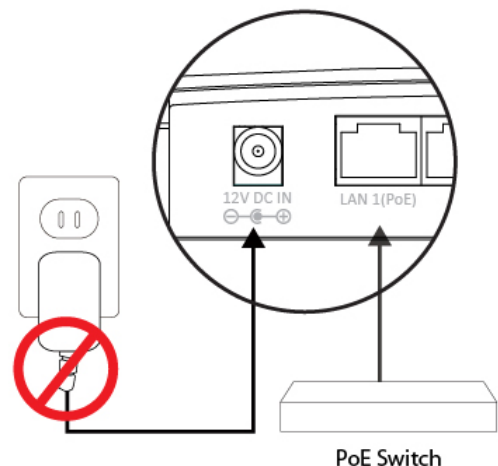

4. Connect a local network client or switch to the access point's **LAN 2** port as required.

 **The access point's LAN 2 port can support another powered device(PD).**

IV. Browser Based Configuration Interface

The browser-based configuration interface enables you to configure the access point's advanced features. The EW-7679WAC features a range of advanced functions such as MAC filtering, MAC RADIUS authentication, VLAN configurations, up to 32 SSIDs and many more. To access the browser based configuration interface:

1. Connect a computer to your access point using an Ethernet cable.
2. Enter your access point's IP address in the URL bar of a web browser. The access point's default IP address is **192.168.2.2**.
3. You will be prompted for a username and password. The default username is "admin" and the default password is "1234", though it was recommended that you change the password during setup (see II-2. Basic Settings).

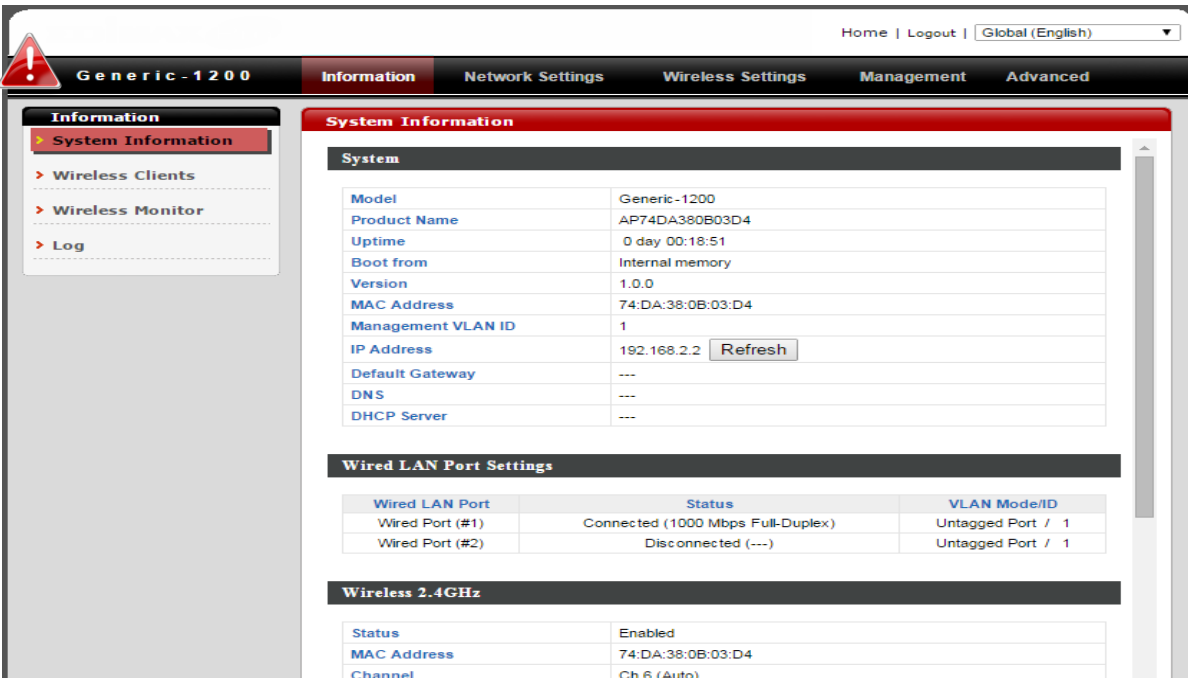

The screenshot displays the web configuration interface for a Generic-1200 access point. The interface has a dark header with navigation tabs: Information, Network Settings, Wireless Settings, Management, and Advanced. The 'Information' tab is selected, and the 'System Information' sub-tab is active. The main content area shows system details in a table format, including Model, Product Name, Uptime, Boot from, Version, MAC Address, Management VLAN ID, IP Address (with a Refresh button), Default Gateway, DNS, and DHCP Server. Below this, there are sections for 'Wired LAN Port Settings' and 'Wireless 2.4GHz' settings.

System Information	
Model	Generic-1200
Product Name	AP74DA380B03D4
Uptime	0 day 00:18:51
Boot from	Internal memory
Version	1.0.0
MAC Address	74:DA:38:0B:03:D4
Management VLAN ID	1
IP Address	192.168.2.2 <input type="button" value="Refresh"/>
Default Gateway	---
DNS	---
DHCP Server	---

Wired LAN Port Settings		
Wired LAN Port	Status	VLAN Mode/ID
Wired Port (#1)	Connected (1000 Mbps Full-Duplex)	Untagged Port / 1
Wired Port (#2)	Disconnected (---)	Untagged Port / 1

Wireless 2.4GHz	
Status	Enabled
MAC Address	74:DA:38:0B:03:D4
Channel	Ch 6 (Auto)

If you cannot remember your password, reset the access point back to its factory default settings. Refer to I-5. Reset

4. You will arrive at the "System Information" screen shown below.

5. Use the menu across the top and down the left side to navigate.

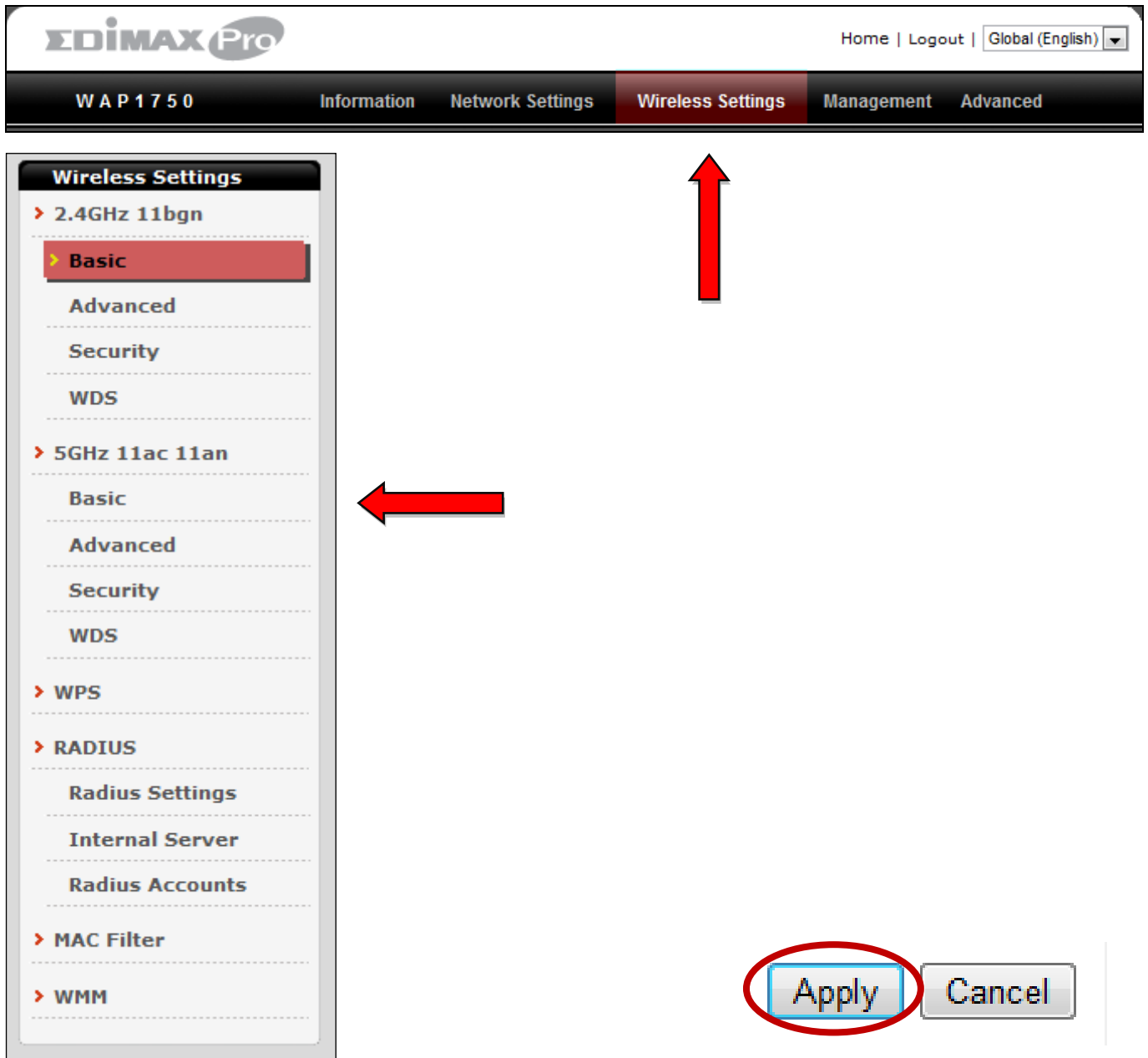

6. Click “Apply” to save changes and reload the access point, or “Cancel” to cancel changes.

 **Please wait a few seconds for the access point to reload after you “Apply” changes, as shown below.**

Configuration is complete. Reloading now... Please wait for seconds.

7. Please refer to the following chapters for full descriptions of the browser based configuration interface features.

IV-1. Information

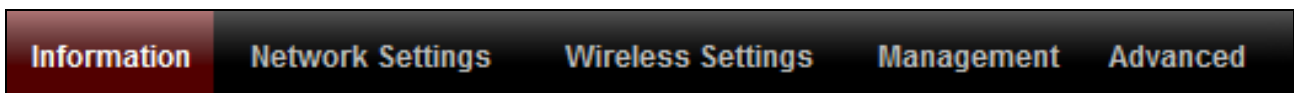

Screenshots displayed are examples. The information shown on your screen will vary depending on your configuration.

IV-1-1. System Information

> System Information

The “System Information” page displays basic system information about the access point.

System	
Model	Generic-1200
Product Name	AP74DA380B03D4
Uptime	0 day 00:18:51
Boot from	Internal memory
Version	1.0.0
MAC Address	74:DA:38:0B:03:D4
Management VLAN ID	1
IP Address	192.168.2.2 <input type="button" value="Refresh"/>
Default Gateway	---
DNS	---
DHCP Server	---

Wired LAN Port Settings		
Wired LAN Port	Status	VLAN Mode/ID
Wired Port (#1)	Connected (1000 Mbps Full-Duplex)	Untagged Port / 1
Wired Port (#2)	Disconnected (---)	Untagged Port / 1

Wireless 2.4GHz	
Status	Enabled
MAC Address	74:DA:38:0B:03:D4
Channel	Ch 6 (Auto)

Wireless 2.4GHz

Status	Enabled
MAC Address	74:DA:38:0B:03:D4
Channel	Ch 1 + 5
Transmit Power	100%

Wireless 2.4GHz /SSID

SSID	Authentication Method	Encryption Type	VLAN ID	Additional Authentication	Wireless Client Isolation
Q002G	No Authentication	No Encryption	1	No additional authentication	Disabled

Wireless 2.4GHz /WDS Disabled

MAC Address	Encryption Type	VLAN Mode/ID
No WDS entries.		

Wireless 5GHz

Status	Enabled
MAC Address	74:DA:38:0B:03:D5
Channel	Ch 36 + 40 + 44 + 48
Transmit Power	100%

Wireless 5GHz /SSID

SSID	Authentication Method	Encryption Type	VLAN ID	Additional Authentication	Wireless Client Isolation
Q005G	No Authentication	No Encryption	1	No additional authentication	Disabled

Wireless 5GHz /WDS Disabled

MAC Address	Encryption Type	VLAN Mode/ID
No WDS entries.		

System

Model	Displays the model number of the access point.
Product Name	Displays the product name for reference, which consists of "AP" plus the MAC address.
Uptime	Displays the total time since the device was turned on.
Boot From	Displays information for the booted hardware, booted from either USB or internal

	memory.
Version	Displays the firmware version.
MAC Address	Displays the access point's MAC address.
Management VLAN ID	Displays the management VLAN ID.
IP Address	Displays the IP address of this device. Click "Refresh" to update this value.
Default Gateway	Displays the IP address of the default gateway.
DNS	IP address of DNS (Domain Name Server)
DHCP Server	IP address of DHCP Server.

<i>Wired LAN Port Settings</i>	
Wired LAN Port	Specifies which LAN port (1 or 2).
Status	Displays the status of the specified LAN port (connected or disconnected).
VLAN Mode/ID	Displays the VLAN mode (tagged or untagged) and VLAN ID for the specified LAN port. See IV-2-3. VLAN

<i>Wireless 2.4GHz (5GHz)</i>	
Status	Displays the status of the 2.4GHz or 5GHz wireless (enabled or disabled).
MAC Address	Displays the access point's MAC address.
Channel	Displays the channel number the specified wireless frequency is using for broadcast.
Transmit Power	Displays the wireless radio transmit power level as a percentage.

<i>Wireless 2.4GHZ (5GHz) / SSID</i>	
SSID	Displays the SSID name(s) for the specified frequency.
Authentication Method	Displays the authentication method for the specified SSID. See IV-3. Wireless Settings
Encryption Type	Displays the encryption type for the specified SSID. See IV-3. Wireless Settings
VLAN ID	Displays the VLAN ID for the specified SSID. See IV-2-3. VLAN

Additional Authentication	Displays the additional authentication type for the specified SSID. See IV-3. Wireless Settings
Wireless Client Isolation	Displays whether wireless client isolation is in use for the specified SSID. See IV-2-3. VLAN

Wireless 2.4GHZ (5GHz) / WDS Status

MAC Address	Displays the peer access point's MAC address.
Encryption Type	Displays the encryption type for the specified WDS. See IV-3-1-4. WDS
VLAN Mode/ID	Displays the VLAN ID for the specified WDS. See IV-3-1-4. WDS

Refresh	Click to refresh all information.
----------------	-----------------------------------

IV-1-2. Wireless Clients

> Wireless Clients

The “Wireless Clients” page displays information about all wireless clients connected to the access point on the 2.4GHz or 5GHz frequency.

Refresh time

Auto Refresh time	<input checked="" type="radio"/> 5 seconds <input type="radio"/> 1 second <input type="radio"/> Disable
Manual Refresh	<input type="button" value="Refresh"/>

2.4GHz WLAN Client Table

SSID	MAC Address	Tx	Rx	Signal (%)	Connected Time	Idle Time	Vendor
No wireless client							

5GHz WLAN Client Table

#	SSID	MAC Address	Tx	Rx	Signal (%)	Connected Time	Idle Time	Vendor
No wireless client								

<i>Refresh time</i>	
Auto Refresh Time	Select a time interval for the client table list to automatically refresh.
Manual Refresh	Click refresh to manually refresh the client table.

<i>2.4GHz (5GHz) WLAN Client Table</i>	
SSID	Displays the SSID which the client is connected to.
MAC Address	Displays the MAC address of the client.
Tx	Displays the total data packets transmitted by the specified client.
Rx	Displays the total data packets received by the specified client.

Signal (%)	Displays the wireless signal strength for the specified client.
Connected Time	Displays the total time the wireless client has been connected to the access point.
Idle Time	Client idle time is the time for which the client has not transmitted any data packets i.e. is idle.
Vendor	The vendor of the client's wireless adapter is displayed here.

IV-1-3. Wireless Monitor

Wireless Monitor Wireless Monitor is a tool built into the access point to scan and monitor the surrounding wireless environment. Select a frequency and click “Scan” to display a list of all SSIDs within range along with relevant details for each SSID.

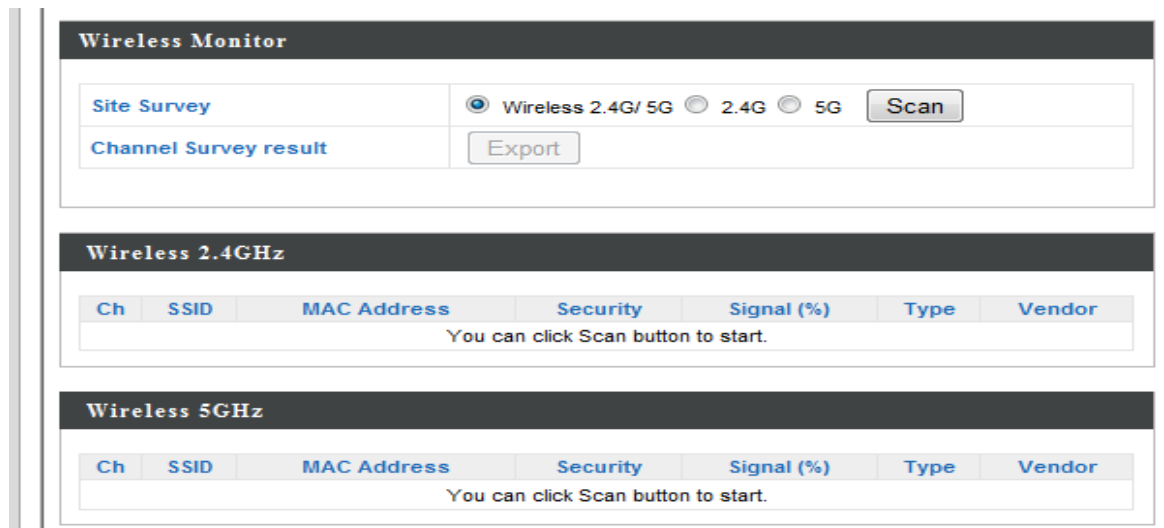

<i>Wireless Monitor</i>	
Site Survey	Select which frequency (or both) to scan, and click “Scan” to begin.
Channel Survey Result	After a scan is complete, click “Export” to save the results to local storage.

<i>Site Survey Results</i>	
Ch	Displays the channel number used by the specified SSID.
SSID	Displays the SSID identified by the scan.
MAC Address	Displays the MAC address of the wireless router/access point for the specified SSID.
Security	Displays the authentication/encryption type of the specified SSID.
Signal (%)	Displays the current signal strength of the SSID.
Type	Displays the 802.11 wireless networking standard(s) of the specified SSID.
Vendor	Displays the vendor of the wireless router/access point for the specified SSID.

IV-1-4. Log

> System Log

The system log displays system operation information such as up time and connection processes. This information is useful for network administrators.



When the log is full, old entries are overwritten.

```
Jan 1 00:00:16 [SYSTEM]: LAN, Port[1] link is changed to 1000Mbps-Full-Duplex
Jan 1 00:00:16 [SYSTEM]: LAN, Port[0] link status is changed to down
Jan 1 00:00:14 [SYSTEM]: HTTPS, start
Jan 1 00:00:14 [SYSTEM]: HTTP, start
Jan 1 00:00:14 [SYSTEM]: LAN, Firewall Disabled
Jan 1 00:00:14 [SYSTEM]: LAN, NAT Disabled
Jan 1 00:00:13 [SYSTEM]: NET, Firewall Disabled
Jan 1 00:00:13 [SYSTEM]: NET, NAT Disabled
Jan 1 00:00:13 [SYSTEM]: LEDs, light on specific LEDs
Jan 1 00:00:08 [SYSTEM]: WLAN[5G], Channel = 36
Jan 1 00:00:08 [SYSTEM]: WLAN[5G], Wireless Mode = 11ACVHT80
Jan 1 00:00:03 [SYSTEM]: WLAN[2.4G], Channel = 1
Jan 1 00:00:03 [SYSTEM]: WLAN[2.4G], Wireless Mode = 11NGHT40PLUS
Jan 1 00:00:03 [SYSTEM]: DHCP, start
Jan 1 00:00:02 [SYSTEM]: LAN, start
Jan 1 00:00:02 [SYSTEM]: Bridge, start
Jan 1 00:00:02 [SYSTEM]: Bridge, start
Jan 1 00:00:00 [SYSTEM]: SYS, Model Name: Wireless Gigabit Router
Jan 1 00:00:00 [SYSTEM]: SYS, Application Version: 1.0.0
Jan 1 00:00:00 [SYSTEM]: BOOT, Generic-1200
```

Save	Click to save the log as a file on your local computer.
Clear	Clear all log entries.
Refresh	Refresh the current log.

The following information/events are recorded by the log:

- ◆ **USB**
Mount & unmount
- ◆ **Wireless Client**
Connected & disconnected
Key exchange success & fail
- ◆ **Authentication**
Authentication fail or successful.
- ◆ **Association**
Success or fail
- ◆ **Change Settings**
- ◆ **System Boot**
Displays current model name
- ◆ **NTP Client**
- ◆ **Wired Link**
LAN Port link status and speed status
- ◆ **Proxy ARP**
Proxy ARP module start & stop
- ◆ **Bridge**
Bridge start & stop.
- ◆ **SNMP**
SNMP server start & stop.
- ◆ **HTTP**
HTTP start & stop.
- ◆ **HTTPS**
HTTPS start & stop.
- ◆ **SSH**
SSH-client server start & stop.
- ◆ **Telnet**
Telnet-client server start or stop.
- ◆ **WLAN (2.4G)**
WLAN (2.4G) channel status and country/region status
- ◆ **WLAN (5G)**
WLAN (5G) channel status and country/region status
- ◆ **ADT**

IV-2. Network Settings

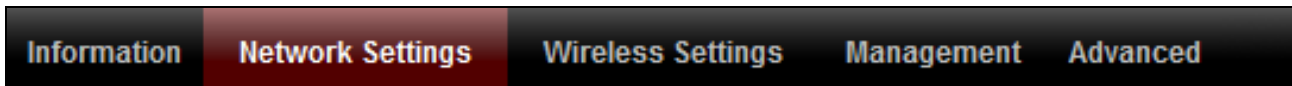

Screenshots displayed are examples. The information shown on your screen will vary depending on your configuration.

IV-2-1. LAN-Side IP Address

> LAN-side IP Address

The “LAN-side IP address” page allows you to configure your access point on your Local Area Network (LAN). You can enable the access point to dynamically receive an IP address from your router’s DHCP server or you can specify a static IP address for your access point, as well as configure DNS servers.



The access point’s default IP address is 192.168.2.2.

LAN-side IP Address	
IP Address Assignment	DHCP Client <input type="button" value="v"/>
IP Address	192.168.2.1
Subnet Mask	255.255.255.0
Default Gateway	From DHCP <input type="button" value="v"/> <input type="text"/>

DNS Servers	
Primary Address	From DHCP <input type="button" value="v"/> <input type="text"/>
Secondary Address	From DHCP <input type="button" value="v"/> <input type="text"/>

LAN-side IP Address

IP Address Assignment

Select “DHCP Client” for your access point to be assigned a dynamic IP address from your router’s DHCP server, or select “Static IP” to manually specify a static/fixed IP address for your access point (below).

IP Address	Specify the IP address here. This IP address will be assigned to your access point and will replace the default IP address.
Subnet Mask	Specify a subnet mask. The default value is 255.255.255.0
Default Gateway	For DHCP users, select “From DHCP” to get default gateway from your DHCP server or “User-Defined” to enter a gateway manually. For static IP users, the default value is blank.

DHCP users can select to get DNS servers’ IP address from DHCP or manually enter a value. For static IP users, the default value is blank.

<i>DNS Servers</i>	
Primary Address	DHCP users can select “From DHCP” to get primary DNS server’s IP address from DHCP or “User-Defined” to manually enter a value. For static IP users, the default value is blank.
Secondary Address	Users can manually enter a value when DNS server’s primary address is set to “User-Defined”.

IV-2-2. LAN Port

> LAN Port

The “LAN Port” page allows you to configure the settings for your access point’s two wired LAN (Ethernet) ports.

Wired LAN Port Settings				
Wired LAN Port	Enable	Speed & Duplex	Flow Control	802.3az
Wired Port (#1)	Enabled ▾	Auto ▾	Enabled ▾	Enabled ▾
Wired Port (#2)	Enabled ▾	Auto ▾	Enabled ▾	Enabled ▾

<i>Wired LAN Port Settings</i>	
Wired LAN Port	Identifies LAN port 1 or 2.
Enable	Enable/disable specified LAN port.
Speed & Duplex	Select a speed & duplex type for specified LAN port, or use the “Auto” value. LAN ports can operate up to 1000Mbps and full-duplex enables simultaneous data packets transfer/receive.
Flow Control	Enable/disable flow control. Flow control can pause new session request until current data processing is complete, in order to avoid device overloads under heavy traffic.
802.3az	Enable/disable 802.3az. 802.3az is an Energy Efficient Ethernet feature which disables unused interfaces to reduce power usage.

IV-2-3. VLAN

> VLAN

The “VLAN” (Virtual Local Area Network) enables you to configure VLAN settings. A VLAN is a local area network which maps workstations virtually instead of physically and allows you to group together or isolate users from each other. VLAN IDs 1 – 4094 are supported.

 **VLAN IDs in the range 1 – 4094 are supported.**

VLAN Interface		
Wired LAN Port	VLAN Mode	VLAN ID
Wired Port (#1)	Untagged Port ▾	1
Wired Port (#2)	Untagged Port ▾	1
Wireless 2.4GHz	VLAN Mode	VLAN ID
SSID [Q002G]	Untagged Port	1
Wireless 5GHz	VLAN Mode	VLAN ID
SSID [Q005G]	Untagged Port	1

Management VLAN	
VLAN ID	1

VLAN Interface	
Wired LAN Port/Wireless	Identifies LAN port 1 or 2 and wireless SSIDs (2.4GHz or 5GHz).
VLAN Mode	Select “Tagged Port” or “Untagged Port” for specified LAN interface.
VLAN ID	Set a VLAN ID for specified interface, if “Untagged Port” is selected.

Management VLAN	
VLAN ID	Specify the VLAN ID of the management VLAN. Only the hosts belonging to the same VLAN can manage the device.

IV-3. Wireless Settings

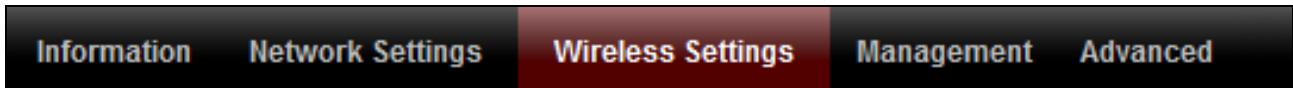

Screenshots displayed are examples. The information shown on your screen will vary depending on your configuration.

IV-3-1. 2.4GHz 11bgn

➤ 2.4GHz 11bgn

The “2.4GHz 11bgn” menu allows you to view and configure information for your access point’s 2.4GHz wireless network across four categories: Basic, Advanced, Security and WDS.

IV-3-1-1. Basic

> Basic

The “Basic” screen displays basic settings for your access point’s 2.4GHz Wi-Fi network (s).

2.4GHz Basic Settings	
Wireless	<input checked="" type="radio"/> Enable <input type="radio"/> Disable
Band	11b/g/n ▼
Enable SSID number	1 ▼
SSID1	Generic-1200-0B03D4_G VLAN ID 1
Auto Channel	<input checked="" type="radio"/> Enable <input type="radio"/> Disable
Auto Channel Range	Ch 1 - 11 ▼
Auto Channel Interval	One day ▼ <input type="checkbox"/> Change channel even if clients are connected
Channel Bandwidth	Auto ▼
BSS BasicRateSet	1,2,5.5,11 Mbps ▼



Auto Channel	<input type="radio"/> Enable <input checked="" type="radio"/> Disable
Channel	Ch 11 ▼
Channel Bandwidth	Auto, +Ch 7 ▼
BSS BasicRateSet	1,2,5.5,11 Mbps ▼

<i>2.4GHz Basic Settings</i>	
Wireless	Enable or disable the access point's 2.4GHz wireless radio. When disabled, no 2.4GHz SSIDs will be active.
Band	Select the wireless standard used for the access point. Combinations of 802.11b, 802.11g & 802.11n can be selected.
Enable SSID Number	Select how many SSIDs to enable for the 2.4GHz frequency from the drop down menu. A maximum of 16 can be enabled.
SSID#	Enter the SSID name for the specified SSID (up to 16). The SSID can consist of any combination of up to 32 alphanumeric characters.
VLAN ID	Specify a VLAN ID for each SSID.
Auto Channel	Enable/disable auto channel selection. Auto channel selection will automatically set the wireless channel for the access point's 2.4GHz frequency based on availability and potential interference. When disabled, select a channel manually as shown in the next table.
Auto Channel Range	Select a range from which the auto channel setting (above) will choose a channel.
Auto Channel Interval	Specify a frequency for how often the auto channel setting will check/reassign the wireless channel. Check/uncheck the "Change channel even if clients are connected" box according to your preference.
Channel Bandwidth	Set the channel bandwidth: 20MHz (lower performance but less interference), 40MHz (higher performance but potentially higher interference) or Auto (automatically select based on interference level).
BSS BasicRateSet	Set a Basic Service Set (BSS) rate: this is a series of rates to control communication frames for wireless clients.

When auto channel is disabled, select a wireless channel manually:

Channel	Select a wireless channel from 1 – 11 (1-13).
Channel Bandwidth	Set the channel bandwidth: 20MHz (lower performance but less interference), 40MHz (higher performance but potentially higher interference) or Auto (automatically select based on interference level).
BSS BasicRate Set	Set a Basic Service Set (BSS) rate: this is a series of rates to control communication frames for wireless clients.

IV-3-1-2. Advanced

> Advanced

These settings are for experienced users only. Please do not change any of the values on this page unless you are already familiar with these functions.



Changing these settings can adversely affect the performance of your access point.

2.4GHz Advanced Settings	
Contention Slot	Short ▾
Preamble Type	Short ▾
Guard Interval	Short GI ▾
802.11g Protection	<input checked="" type="radio"/> Enable <input type="radio"/> Disable
802.11n Protection	<input checked="" type="radio"/> Enable <input type="radio"/> Disable
DTIM Period	1 (1-255)
RTS Threshold	2347 (1-2347)
Fragment Threshold	2346 (256-2346)
Multicast Rate	Auto ▾
Tx Power	100% ▾
Beacon Interval	100 (40-1000 ms)
Station idle timeout	60 (30-65535 seconds)

2.4GHz Advanced Settings	
Contention Slot	Select “Short” or “Long” – this value is used for contention windows in WMM (see IV-3-6. WMM).
Preamble Type	Set the wireless radio preamble type. The preamble type in 802.11 based wireless communication defines the length of the CRC (Cyclic Redundancy Check) block for communication between the access point and roaming wireless adapters. The default value is “Short Preamble”.
Guard Interval	Set the guard interval. A shorter interval can improve performance.

802.11g Protection	Enable/disable 802.11g protection, which increases reliability but reduces bandwidth (clients will send Request to Send (RTS) to access point, and access point will broadcast Clear to Send (CTS), before a packet is sent from client.)
802.11n Protection	Enable/disable 802.11n protection, which increases reliability but reduces bandwidth (clients will send Request to Send (RTS) to access point, and access point will broadcast Clear to Send (CTS), before a packet is sent from client.)
DTIM Period	Set the DTIM (delivery traffic indication message) period value of the wireless radio. The default value is 1.
RTS Threshold	Set the RTS threshold of the wireless radio. The default value is 2347.
Fragment Threshold	Set the fragment threshold of the wireless radio. The default value is 2346.
Multicast Rate	Set the transfer rate for multicast packets or use the "Auto" setting.
Tx Power	Set the power output of the wireless radio. You may not require 100% output power. Setting a lower power output can enhance security since potentially malicious/unknown users in distant areas will not be able to access your signal.
Beacon Interval	Set the beacon interval of the wireless radio. The default value is 100.
Station idle timeout	Set the interval for keepalive messages from the access point to a wireless client to verify if the station is still alive/active.

IV-3-1-3. Security

> Security

The access point provides various security options (wireless data encryption). When data is encrypted, information transmitted wirelessly cannot be read by anyone who does not know the correct encryption key.



It's essential to configure wireless security in order to prevent unauthorised access to your network.



Select hard-to-guess passwords which include combinations of numbers, letters and symbols, and change your password regularly.

Security

2.4GHz Wireless Security Settings

SSID	Generic-1200-0B03D4_G ▾
Broadcast SSID	Enable ▾
Wireless Client Isolation	Disable ▾
Load Balancing	50 /50
Authentication Method	No Authentication ▾
Additional Authentication	No additional authentication ▾

Apply Cancel

<i>2.4GHz Wireless Security Settings</i>	
SSID Selection	Select which SSID to configure security settings for.
Broadcast SSID	Enable or disable SSID broadcast. When enabled, the SSID will be visible to clients as an available Wi-Fi network. When disabled, the SSID will not be visible as an available Wi-Fi network to clients – clients must manually enter the SSID in order to connect. A hidden (disabled) SSID is typically more secure than a visible (enabled) SSID.
Wireless Client Isolation	Enable or disable wireless client isolation. Wireless client isolation prevents clients connected to the access point from communicating with each other and improves security. Typically, this function is useful for corporate environments or public hot spots and can prevent brute force attacks on clients' usernames and passwords.
Load Balancing	Load balancing limits the number of wireless clients connected to an SSID. Set a load balancing value (maximum 50).
Authentication Method	Select an authentication method from the drop down menu and refer to the information below appropriate for your method.
Additional Authentication	Select an additional authentication method from the drop down menu and refer to the information below (IV-3-1-3-6.) appropriate for your method.

IV-3-1-3-1. No Authentication

Authentication is disabled and no password/key is required to connect to the access point.



Disabling wireless authentication is not recommended. When disabled, anybody within range can connect to your device's SSID.

IV-3-1-3-2. WEP

WEP (Wired Equivalent Privacy) is a basic encryption type. For a higher level of security consider using WPA encryption.

Key Length	Select 64-bit or 128-bit. 128-bit is more secure than 64-bit and is recommended.
Key Type	Choose from "ASCII" (any alphanumerical character 0-9, a-z and A-Z) or "Hex" (any characters from 0-9, a-f and A-F).
Default Key	Select which encryption key (1 – 4 below) is the default key. For security purposes, you can set up to four keys (below) and change which is the default key.
Encryption Key 1 – 4	Enter your encryption key/password according to the format you selected above.

IV-3-1-3-3. IEEE802.1x/EAP

Key Length	Select 64-bit or 128-bit. 128-bit is more secure than 64-bit and is recommended.
-------------------	----------------------------------------------------------------------------------

IV-3-1-3-4. WPA-PSK

WPA-PSK is a secure wireless encryption type with strong data protection and user authentication, utilizing 128-bit encryption keys.

WPA Type	Select from WPA/WPA2 Mixed Mode-PSK, WPA2 or WPA only. WPA2 is safer than WPA only, but not supported by all wireless clients. Please make sure your wireless client supports your selection.
Encryption	Select "TKIP/AES Mixed Mode" or "AES" encryption type.
Key Renewal Interval	Specify a frequency for key renewal in minutes.
Pre-Shared Key	Choose from "Passphrase" (8 – 63

Type	alphanumeric characters) or “Hex” (up to 64 characters from 0-9, a-f and A-F).
Pre-Shared Key	Please enter a security key/password according to the format you selected above.

IV-3-1-3-5. WPA-EAP

WPA Type	Select from WPA/WPA2 Mixed Mode-EAP, WPA2-EAP or WPA-EAP.
Encryption	Select “TKIP/AES Mixed Mode” or “AES” encryption type.
Key Renewal Interval	Specify a frequency for key renewal in minutes.



WPA-EAP must be disabled to use MAC-RADIUS authentication.

IV-3-1-3-6. Additional Authentication

Additional wireless authentication methods can also be used:

MAC Address Filter

Restrict wireless clients access based on MAC address specified in the MAC filter table.



See IV-3-5.MAC Filter to configure MAC filtering.

MAC Filter & MAC-RADIUS Authentication

Restrict wireless clients access using both of the above MAC filtering & RADIUS authentication methods.

MAC-RADIUS Authentication

Restrict wireless clients access based on MAC address via a RADIUS server, or password authentication via a RADIUS server.



See IV-3-4.RADIUS to configure RADIUS servers.



WPS must be disabled to use MAC-RADIUS authentication. See IV-3-3. for WPS settings.

MAC RADIUS Password

- Use MAC address
- Use the following password

MAC RADIUS Password	Select whether to use MAC address or password authentication via RADIUS server. If you select “Use the following password”, enter the password in the field below. The password should match the “Shared Secret” used in IV-3-4. RADIUS.
----------------------------	-------------------------------------------------------------------------------------------------------------------------------------------------------------------------------------------------------------------------------------------------

IV-3-1-4. WDS

> WDS Wireless Distribution System (WDS) can bridge/repeat access points together in an extended network. WDS settings can be configured as shown below.



When using WDS, configure the IP address of each access point to be in the same subnet and ensure there is only one active DHCP server among connected access points, preferably on the WAN side.

WDS must be configured on each access point, using correct MAC addresses. All access points should use the same wireless channel and encryption method.

2.4GHz	
WDS Functionality	Disabled
Local MAC Address	WDS with AP
	Dedicated WDS

WDS Peer Settings	
WDS #1	MAC Address <input type="text"/>
WDS #2	MAC Address <input type="text"/>
WDS #3	MAC Address <input type="text"/>
WDS #4	MAC Address <input type="text"/>

WDS VLAN	
VLAN Mode	Untagged Port <input type="text"/>
VLAN ID	1 <input type="text"/>

WDS Encryption method	
Encryption	None <input type="text"/>

<i>2.4GHz</i>	
WDS Functionality	Select “WDS with AP” to use WDS with access point or “WDS Dedicated Mode” to use WDS and also block communication with regular wireless clients. When WDS is used, each access point should be configured with corresponding MAC addresses, wireless channel and wireless encryption method.
Local MAC Address	Displays the MAC address of your access point.

<i>WDS Peer Settings</i>	
WDS #	Enter the MAC address for up to four other WDS devices you wish to connect.

<i>WDS VLAN</i>	
VLAN Mode	Specify the WDS VLAN mode to “Untagged Port” or “Tagged Port”.
VLAN ID	Specify the WDS VLAN ID when “Untagged Port” is selected above.

<i>WDS Encryption method</i>	
Encryption	Select whether to use “None” or “AES” encryption and enter a pre-shared key for AES consisting of 8-63 alphanumeric characters.

IV-3-2. 5GHz 11ac 11an

> 5GHz 11ac 11an

The “5GHz 11ac 11an” menu allows you to view and configure information for your access point’s 5GHz wireless network across four categories: Basic, Advanced, Security and WDS.

IV-3-2-1. Basic

> Basic

The “Basic” screen displays basic settings for your access point’s 5GHz Wi-Fi network (s).

5GHz Basic Settings	
Wireless	<input checked="" type="radio"/> Enable <input type="radio"/> Disable
Band	11a/n/ac
Enable SSID number	1
SSID1	QOO5G VLAN ID 1
Auto Channel	<input checked="" type="radio"/> Enable <input type="radio"/> Disable
Auto Channel Range	Band 1
Auto Channel Interval	One day <input type="checkbox"/> Change channel even if clients are connected
Channel Bandwidth	Auto 80/40/20 MHz
BSS BasicRateSet	6,12,24 Mbps



Auto Channel	<input type="radio"/> Enable <input checked="" type="radio"/> Disable
Channel	Ch 36, 5.18GHz
Channel Bandwidth	Auto 80/40/20 MHz
BSS BasicRateSet	6,12,24 Mbps

<i>5GHz Basic Settings</i>	
Wireless	Enable or disable the access point's 5GHz wireless radio. When disabled, no 5GHz SSIDs will be active.
Band	Select the wireless standard used for the access point. Combinations of 802.11a, 802.11n & 802.11ac can be selected.
Enable SSID Number	Select how many SSIDs to enable for the 5GHz frequency from the drop down menu. A maximum of 16 can be enabled.
SSID#	Enter the SSID name for the specified SSID (up to 16). The SSID can consist of any combination of up to 32 alphanumeric characters.
VLAN ID	Specify a VLAN ID for each SSID.
Auto Channel	Enable/disable auto channel selection. Auto channel selection will automatically set the wireless channel for the access point's 5GHz frequency based on availability and potential interference. When disabled, select a channel manually as shown in the next table.
Auto Channel Range	Select a range from which the auto channel setting (above) will choose a channel.
Auto Channel Interval	Specify a frequency for how often the auto channel setting will check/reassign the wireless channel. Check/uncheck the "Change channel even if clients are connected" box according to your preference.
Channel Bandwidth	Set the channel bandwidth: 20MHz (lower performance but less interference), Auto 40/20MHz or Auto 80/40/20MHz (automatically select based on interference level).
BSS BasicRate Set	Set a Basic Service Set (BSS) rate: this is a series of rates to control communication frames for wireless clients.

When auto channel is disabled, select a wireless channel manually:

Channel	Select a wireless channel.
Channel Bandwidth	Set the channel bandwidth: 20MHz (lower performance but less interference), Auto 40/20MHz or Auto 80/40/20MHz (automatically select based on interference level).
BSS BasicRate Set	Set a Basic Service Set (BSS) rate: this is a series of rates to control communication frames for wireless clients.

IV-3-2-2. Advanced

Advanced

These settings are for experienced users only. Please do not change any of the values on this page unless you are already familiar with these functions.



Changing these settings can adversely affect the performance of your access point.

5GHz Advanced Settings	
Guard Interval	Short GI ▾
802.11n Protection	<input checked="" type="radio"/> Enable <input type="radio"/> Disable
DTIM Period	1 (1-255)
RTS Threshold	2347 (1-2347)
Fragment Threshold	2346 (256-2346)
Multicast Rate	Auto ▾
Tx Power	100% ▾
Beacon Interval	100 (40-1000 ms)
Station idle timeout	60 (30-65535 seconds)

5GHz Advanced Settings	
Guard Interval	Set the guard interval. A shorter interval can improve performance.
802.11n Protection	Enable/disable 802.11n protection, which increases reliability but reduces bandwidth (clients will send Request to Send (RTS) to access point, and access point will broadcast Clear to Send (CTS), before a packet is sent from client.)
DTIM Period	Set the DTIM (delivery traffic indication message) period value of the wireless radio. The default value is 1.
RTS Threshold	Set the RTS threshold of the wireless radio. The default value is 2347.
Fragment Threshold	Set the fragment threshold of the wireless radio. The default value is 2346.

Multicast Rate	Set the transfer rate for multicast packets or use the "Auto" setting.
Tx Power	Set the power output of the wireless radio. You may not require 100% output power. Setting a lower power output can enhance security since potentially malicious/unknown users in distant areas will not be able to access your signal.
Beacon Interval	Set the beacon interval of the wireless radio. The default value is 100.
Station idle timeout	Set the interval for keepalive messages from the access point to a wireless client to verify if the station is still alive/active.

IV-3-2-3. Security

Security

The access point provides various security options (wireless data encryption). When data is encrypted, information transmitted wirelessly cannot be read by anyone who does not know the correct encryption key.

 ***It's essential to configure wireless security in order to prevent unauthorised access to your network.***

 ***Select hard-to-guess passwords which include combinations of numbers, letters and symbols, and change your password regularly.***

5GHz Wireless Security Settings	
SSID	Q005G ▾
Broadcast SSID	Enable ▾
Wireless Client Isolation	Disable ▾
Load Balancing	50 /50
Authentication Method	No Authentication ▾
Additional Authentication	No additional authentication ▾

5GHz Wireless Security Settings	
SSID Selection	Select which SSID to configure security settings for.
Broadcast SSID	Enable or disable SSID broadcast. When enabled, the SSID will be visible to clients as an available Wi-Fi network. When disabled, the SSID will not be visible as an available Wi-Fi network to clients – clients must manually enter the SSID in order to connect. A hidden (disabled) SSID is typically more secure than a visible (enabled) SSID.

Wireless Client Isolation	Enable or disable wireless client isolation. Wireless client isolation prevents clients connected to the access point from communicating with each other and improves security. Typically, this function is useful for corporate environments or public hot spots and can prevent brute force attacks on clients' usernames and passwords.
Load Balancing	Load balancing limits the number of wireless clients connected to an SSID. Set a load balancing value (maximum 50).
Authentication Method	Select an authentication method from the drop down menu and refer to the information below appropriate for your method.
Additional Authentication	Select an additional authentication method from the drop down menu and refer to the information below appropriate for your method.

Please refer back to **IV-3-1-3. Security** for more information on authentication and additional authentication types.

IV-3-2-4. WDS

➤ WDS

Wireless Distribution System (WDS) can bridge/repeat access points together in an extended network. WDS settings can be

configured as shown below.



When using WDS, configure the IP address of each access point to be in the same subnet and ensure there is only one active DHCP server among connected access points, preferably on the WAN side.

WDS must be configured on each access point, using correct MAC addresses. All access points should use the same wireless channel and encryption method.

5GHz WDS Mode	
WDS Functionality	Disabled WDS with AP Dedicated WDS
Local MAC Address	80:1F:02:F1:96:8B

WDS Peer Settings	
WDS #1	MAC Address <input type="text"/>
WDS #2	MAC Address <input type="text"/>
WDS #3	MAC Address <input type="text"/>
WDS #4	MAC Address <input type="text"/>

WDS VLAN	
VLAN Mode	Untagged Port ▼
VLAN ID	1

Encryption method	
Encryption	None ▼

<i>5GHz WDS Mode</i>	
WDS Functionality	Select “WDS with AP” to use WDS with access point or “WDS Dedicated Mode” to use WDS and also block communication with regular wireless clients. When WDS is used, each access point should be configured with corresponding MAC addresses, wireless channel and wireless encryption method.
Local MAC Address	Displays the MAC address of your access point.

<i>WDS Peer Settings</i>	
WDS #	Enter the MAC address for up to four other WDA devices you wish to connect.

<i>WDS VLAN</i>	
VLAN Mode	Specify the WDS VLAN mode to “Untagged Port” or “Tagged Port”.
VLAN ID	Specify the WDS VLAN ID when “Untagged Port” is selected above.

<i>WDS Encryption</i>	
Encryption	Select whether to use “None” or “AES” encryption and enter a pre-shared key for AES with 8-63 alphanumeric characters.

IV-3-3. RADIUS

RADIUS

The RADIUS sub menu allows you to configure the access point's RADIUS server settings, categorized into three submenus: RADIUS settings, Internal Server and RADIUS accounts.

A RADIUS server provides user-based authentication to improve security and offer wireless client control – users can be authenticated before gaining access to a network.

The access point can utilize both a primary and secondary (backup) RADIUS server for each of its wireless frequencies (2.4GHz & 5GHz). External RADIUS servers can be used or the access point's internal RADIUS server can be used.



To use RADIUS servers, go to “Wireless Settings” → “Security” and select “MAC RADIUS Authentication” → “Additional Authentication” and select “MAC RADIUS Authentication” (see IV-3-1-3. & IV-3-2-3).

IV-3-4-1. RADIUS Settings

➤ Radius Settings

Configure the RADIUS server settings for 2.4GHz & 5GHz. Each frequency can use an internal or external RADIUS server.

Primary RADIUS Server	
RADIUS Type	<input type="radio"/> Internal <input checked="" type="radio"/> External
RADIUS Server	<input type="text"/>
Authentication Port	<input type="text" value="1812"/>
Shared Secret	<input type="text"/>
Session Timeout	<input type="text" value="3600"/> second(s)
Accounting	<input checked="" type="radio"/> Enable <input type="radio"/> Disable
Accounting Port	<input type="text" value="1813"/>

Secondary RADIUS Server	
RADIUS Type	<input type="radio"/> Internal <input checked="" type="radio"/> External
RADIUS Server	<input type="text"/>
Authentication Port	<input type="text" value="1812"/>
Shared Secret	<input type="text"/>
Session Timeout	<input type="text" value="3600"/> second(s)
Accounting	<input checked="" type="radio"/> Enable <input type="radio"/> Disable
Accounting Port	<input type="text" value="1813"/>

RADIUS Type	Select “Internal” to use the access point’s built-in RADIUS server or “external” to use an external RADIUS server.
RADIUS Server	Enter the RADIUS server host IP address.
Authentication Port	Set the UDP port used in the authentication protocol of the RADIUS server. Value must be between 1 – 65535.
Shared Secret	Enter a shared secret/password between 1 – 99 characters in length. This should match the “MAC-RADIUS” password used in IV-3-1-3-6 or IV-3-2-3 .

Session Timeout	Set a duration of session timeout in seconds between 0 – 86400.
Accounting	Enable or disable RADIUS accounting.
Accounting Port	When accounting is enabled (above), set the UDP port used in the accounting protocol of the RADIUS server. Value must be between 1 – 65535.

IV-3-4-2. Internal Server

> Internal Server The access point features a built-in RADIUS server which can be configured as shown below used when “Internal” is selected for “RADIUS Type” in the “Wireless Settings” → “RADIUS” → “RADIUS Settings” menu.

 **To use RADIUS servers, go to “Wireless Settings” → “Security” and select “MAC RADIUS Authentication” → “Additional Authentication” and select “MAC RADIUS Authentication” (see IV-3-1-3. & IV-3-2-3).**

Internal Server

Internal Server	<input type="checkbox"/> Enable
EAP Internal Authentication	PEAP(MS-PEAP) ▼
EAP Certificate File Format	PKCS#12(*.pfx/*.p12)
EAP Certificate File	<input type="button" value="Upload"/>
Shared Secret	<input type="text"/>
Session-Timeout	<input type="text" value="3600"/> second(s)
Termination-Action	<input checked="" type="radio"/> Reauthentication (RADIUS-Request) <input type="radio"/> Not-Reauthentication (Default) <input type="radio"/> Not-Send

Internal Server	Check/uncheck to enable/disable the access point’s internal RADIUS server.
EAP Internal Authentication	Select EAP internal authentication type from the drop down menu.

EAP Certificate File Format	Displays the EAP certificate file format: PCK#12(*.pfx/*.p12)
EAP Certificate File	Click “Upload” to open a new window and select the location of an EAP certificate file to use. If no certificate file is uploaded, the internal RADIUS server will use a self-made certificate.
Shared Secret	Enter a shared secret/password for use between the internal RADIUS server and RADIUS client. The shared secret should be 1 – 99 characters in length. This should match the “MAC-RADIUS” password used in IV-3-1-3-6 or IV-3-2-3 .
Session Timeout	Set a duration of session timeout in seconds between 0 – 86400.
Termination Action	Select a termination-action attribute: “Reauthentication” sends a RADIUS request to the access point, “Not-Reauthentication” sends a default termination-action attribute to the access point, “Not-Send” no termination-action attribute is sent to the access point.

IV-3-4-3. RADIUS Accounts

> Radius Accounts The internal RADIUS server can authenticate up to 256 user accounts. The “RADIUS Accounts” page allows you to configure and manage users.

The screenshot displays the RADIUS Accounts configuration interface, divided into three main sections:

- Radius Accounts:** This section features a header, a "User Name" label, an example string "Example: EDIMAX-USER1, EDIMAX-USER2, EDIMAX-USER3, EDIMAX-USER4", and a large text input field with the placeholder "Enter user name here". Below the input field are "Add" and "Reset" buttons.
- User Registration List:** This section contains a table with columns for "Select", "User Name", "Password", and "Customize". The table lists one user with "User Name" EDIMAX and "Password" Not Configured. An "Edit" button is located in the "Customize" column. Below the table are "Delete Selected" and "Delete All" buttons. A red arrow points from the "Edit" button down to the next section.
- Edit User Registration List:** This section shows a form for editing a user. It has two rows: "User Name" with the value "EDIMAX" and a "(4-16characters)" constraint, and "Password" with an empty field and a "(6-32characters)" constraint.

User Name	Enter the user names here, separated by commas.
Add	Click “Add” to add the user to the user registration list.
Reset	Clear text from the user name box.

Select	Check the box to select a user.
User Name	Displays the user name.
Password	Displays if specified user name has a password (configured) or not (not configured).
Customize	Click “Edit” to open a new field to set/edit a password for the specified user name (below).

Delete Selected	Delete selected user from the user registration list.
Delete All	Delete all users from the user registration list.

Edit User Registration List

User Name	Existing user name is displayed here and can be edited according to your preference.
Password	Enter or edit a password for the specified user.

IV-3-5. MAC Filter

> MAC Filter

Mac filtering is a security feature that can help to prevent unauthorized users from connecting to your access point.

This function allows you to define a list of network devices permitted to connect to the access point. Devices are each identified by their unique MAC address. If a device which is not on the list of permitted MAC addresses attempts to connect to the access point, it will be denied.

 **To enable MAC filtering, go to “Wireless Settings” → “2.4GHz 11bgn/5GHz 11ac 11an” → “Security” → “Additional Authentication” and select “MAC Filter” (see IV-3-1-3. & IV-3-2-3).**

The MAC address filtering table is displayed below:

Add MAC Addresses

AddReset

MAC Address Filtering Table

Select	MAC Address
<input type="checkbox"/>	FC:F8:AE:43:43:7E

Delete Selected Delete All Export

Add MAC Address	Enter a MAC address of computer or network device manually e.g. 'aa-bb-cc-dd-ee-ff' or enter multiple MAC addresses separated with commas, e.g. 'aa-bb-cc-dd-ee-ff,aa-bb-cc-dd-ee-gg'
Add	Click "Add" to add the MAC address to the MAC address filtering table.
Reset	Clear all fields.

MAC address entries will be listed in the "MAC Address Filtering Table". Select an entry using the "Select" checkbox.

Select	Delete selected or all entries from the table.
MAC Address	The MAC address is listed here.
Delete Selected	Delete the selected MAC address from the list.
Delete All	Delete all entries from the MAC address filtering table.
Export	Click "Export" to save a copy of the MAC filtering table. A new window will pop up for you to select a location to save the file.

IV-3-6. WMM

> WMM

Wi-Fi Multimedia (WMM) is a Wi-Fi Alliance interoperability certification based on the IEEE 802.11e standard, which provides

Quality of Service (QoS) features to IEEE 802.11 networks. WMM prioritizes traffic according to four categories: background, best effort, video and voice.

WMM-EDCA Settings				
WMM Parameters of Access Point				
	CWMin	CWMax	AIFSN	TxOP
Back Ground	4	10	7	0
Best Effort	4	6	3	0
Video	3	4	1	94
Voice	2	3	1	47

WMM Parameters of Station				
	CWMin	CWMax	AIFSN	TxOP
Back Ground	4	10	7	0
Best Effort	4	10	3	0
Video	3	4	2	94
Voice	2	3	2	47

Configuring WMM consists of adjusting parameters on queues for different categories of wireless traffic. Traffic is sent to the following queues:

Background	Low Priority	High throughput, non time sensitive bulk data e.g. FTP
Best Effort	Medium Priority	Traditional IP data, medium throughput and delay.
Video	High Priority	Time sensitive video data with minimum time delay.
Voice	High Priority	Time sensitive data such as VoIP and streaming media with minimum time delay.

Queues automatically provide minimum transmission delays for video, voice, multimedia and critical applications. The values can further be adjusted manually:

CWMin	Minimum Contention Window (milliseconds): This value is input to the initial random backoff wait time algorithm for retry of a data frame transmission. The backoff wait time will be generated between 0 and this value. If the frame is not sent, the random backoff value is doubled until the value reaches the number defined by CWMax (below). The CWMin value must be lower than the CWMax value. The contention window scheme helps to avoid frame collisions and determine priority of frame transmission. A shorter window has a higher probability (priority) of transmission.
CWMax	Maximum Contention Window (milliseconds): This value is the upper limit to random backoff value doubling (see above).
AIFSN	Arbitration Inter-Frame Space (milliseconds): Specifies additional time between when a channel goes idle and the AP/client sends data frames. Traffic with a lower AIFSN value has a higher priority.
TxOP	Transmission Opportunity (milliseconds): The maximum interval of time an AP/client can transmit. This makes channel access more efficiently prioritized. A value of 0 means only one frame per transmission. A greater value effects higher priority.

IV-4. Management

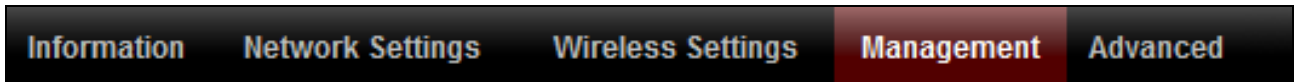

Screenshots displayed are examples. The information shown on your screen will vary depending on your configuration.

IV-4-1. Admin



You can change the password used to login to the browser-based configuration interface here.

It is advised to do so for security purposes.



If you change the administrator password, please make a note of the new password. In the event that you forget this password and are unable to login to the browser based configuration interface, see I-5. Reset for how to reset the access point.

Account to Manage This Device	
Administrator Name	<input type="text" value="admin"/>
Administrator Password	<input type="password" value="•••••"/> (4-32 Characters)
	<input type="password" value="•••••"/> (Confirm)
<input type="button" value="Apply"/>	

Advanced Settings	
Product Name	<input type="text" value="AP801F02F1968A"/>
Management Protocol	<input checked="" type="checkbox"/> HTTP <input checked="" type="checkbox"/> HTTPS <input checked="" type="checkbox"/> TELNET <input type="checkbox"/> SSH <input type="checkbox"/> SNMP
SNMP Version	v1/v2c ▾
SNMP Get Community	<input type="text" value="public"/>
SNMP Set Community	<input type="text" value="private"/>
SNMP Trap	Disabled ▾
SNMP Trap Community	<input type="text" value="public"/>
SNMP Trap Manager	<input type="text"/>
<input type="button" value="Apply"/>	

<i>Account to Manage This Device</i>	
Administrator Name	Set the access point's administrator name. This is used to log in to the browser based configuration interface and must be between 4-16 alphanumeric characters (case sensitive).
Administrator Password	Set the access point's administrator password. This is used to log in to the browser based configuration interface and must be between 4-32 alphanumeric characters (case sensitive).

<i>Advanced Settings</i>	
Product Name	Edit the product name according to your preference consisting of 1-32 alphanumeric characters. This name is used for reference purposes.

Management Protocol	Check/uncheck the boxes to enable/disable specified management interfaces (see below). When SNMP is enabled, complete the SNMP fields below.
SNMP Version	Select SNMP version appropriate for your SNMP manager.
SNMP Get Community	Enter an SNMP Get Community name for verification with the SNMP manager for SNMP-GET requests.
SNMP Set Community	Enter an SNMP Set Community name for verification with the SNMP manager for SNMP-SET requests.
SNMP Trap	Enable or disable SNMP Trap to notify SNMP manager of network errors.
SNMP Trap Community	Enter an SNMP Trap Community name for verification with the SNMP manager for SNMP-TRAP requests.
SNMP Trap Manager	Specify the IP address or sever name (2-128 alphanumeric characters) of the SNMP manager.

HTTP

Internet browser HTTP protocol management interface

HTTPS

Internet browser HTTPS protocol management interface

TELNET

Client terminal with telnet protocol management interface

SSH

Client terminal with SSH protocol version 1 or 2 management interface

SNMP

Simple Network Management Protocol. SNMPv1, v2 & v3 protocol supported. SNMPv2 can be used with community based authentication. SNMPv3 uses user-based security model (USM) architecture.

IV-4-2. Date and Time

> Date and Time

You can configure the time zone settings of your access point here. The date and time of the device can be configured manually or can be synchronized with a time server.

Date and Time Settings	
Local Time	2012 <input type="text"/> Year Jan <input type="text"/> Month 1 <input type="text"/> Day
	0 <input type="text"/> Hours 00 <input type="text"/> Minutes 00 <input type="text"/> Seconds
<input type="button" value="Acquire Current Time from Your PC"/>	

NTP Time Server	
Use NTP	<input type="checkbox"/> Enable
Server Name	<input type="text"/>
Update Interval	24 <input type="text"/> (Hours)

Time Zone	
Time Zone	(GMT) Greenwich Mean Time: Dublin, Edinburgh, Lisbon, London <input type="text"/>

Date and Time Settings	
Local Time	Set the access point's date and time manually using the drop down menus.
Acquire Current Time from your PC	Click "Acquire Current Time from Your PC" to enter the required values automatically according to your computer's current time and date.

<i>NTP Time Server</i>	
Use NTP	The access point also supports NTP (Network Time Protocol) for automatic time and date setup.
Server Name	Enter the host name or IP address of the time server if you wish.
Update Interval	Specify a frequency (in hours) for the access point to update/synchronize with the NTP server.

<i>Time Zone</i>	
Time Zone	Select the time zone of your country/ region. If your country/region is not listed, please select another country/region whose time zone is the same as yours.

IV-4-3. Syslog Server

> Syslog Server

The system log can be sent to a server or to attached USB storage.

Syslog Server Settings	
Transfer Logs	<input type="checkbox"/> Enable Syslog Server <input type="text"/>
Copy Logs to Attached USB Device	<input type="checkbox"/> Enable

Syslog Server	
Transfer Logs	Check/uncheck the box to enable/disable the use of a syslog server, and enter a host name, domain or IP address for the server, consisting of up to 128 alphanumeric characters.
Copy Logs to Attached USB Device	Check/uncheck the box to enable/disable copying logs to attached USB storage.

IV-4-4. I'm Here

> I'm Here

The access point features a built-in buzzer which can sound on command using the “I’m Here” page. This is useful for network administrators and engineers working in complex network environments to locate the access point.

Duration of Sound

Duration of Sound (1-300 seconds)

Sound Buzzer

 ***The buzzer is loud!***

Duration of Sound	Set the duration for which the buzzer will sound when the “Sound Buzzer” button is clicked.
Sound Buzzer	Activate the buzzer sound for the above specified duration of time.

IV-5. Advanced

Information Network Settings Wireless Settings Management **Advanced**



Screenshots displayed are examples. The information shown on your screen will vary depending on your configuration.

IV-5-1. LED Settings

> LED Settings

The access point's LEDs can be manually enabled or disabled according to your preference.

LED Settings	
Power LED	<input checked="" type="radio"/> On <input type="radio"/> Off
Diag LED	<input checked="" type="radio"/> On <input type="radio"/> Off

Power LED	Select on or off.
Diag LED	Select on or off.

IV-5-2. Update Firmware

> Update Firmware

The “Firmware” page allows you to update the system firmware to a more recent version. Updated firmware versions often offer increased performance and security, as well as bug fixes. You can download the latest firmware from the website.

Firmware Location

Update firmware from

a file on your PC

a file on an attached USB device (No USB device connected.)

Update firmware from PC

Firmware Update File

Firmware Location

Update firmware from

a file on your PC

a file on an attached USB device

Update firmware from USB

#	Select	Filename	Target	Version	Size (MB)
1	<input type="radio"/>	WAP1750-FW-V1-0-1-1.bin	WAP1750	1.0.1	7



Do not switch off or disconnect the access point during a firmware upgrade, as this could damage the device.

Update Firmware From	Select to upload firmware from your local computer or from an attached USB device. (You must transfer a firmware file to the USB device first.)
Firmware Update File	Click “Browse” to open a new window to locate and select the firmware file in your computer.
Update	Click “Update” to upload the specified firmware file to your access point.

IV-5-3. Save/Restore Settings

> Save/Restore Settings The access point's "Save/Restore Settings" page enables you to save/backup the access point's current settings as a file to your local computer or a USB device attached to the access point, and restore the access point to previously saved settings.

Save/Restore Method	
Using Device	<input checked="" type="radio"/> Using your PC <input type="radio"/> Using your USB device (No USB device connected.)

Save Settings to PC	
Save Settings	<input type="checkbox"/> Encrypt the configuration file with a password. <input type="text"/>
<input type="button" value="Save"/>	

Restore Settings from PC	
Restore Settings	<input type="text"/> <input type="button" value="Browse..."/> <input type="checkbox"/> Open file with password. <input type="text"/>
<input type="button" value="Restore"/>	

Save/Restore Method

Using Device

Using your PC
 Using your USB device

Save Settings to USB

Save Settings

Encrypt the configuration file with a password.

Save

Restore Settings from USB

Restore Settings

EDIMAX_AP801F02F1968A_20140416_00.bin
 Open file with password.

Restore

<i>Save / Restore Settings</i>	
Using Device	Select to save the access point's settings to your local computer or to an attached USB device.

<i>Save Settings to USB</i>	
Save Settings	Click "Save" to save settings and a new window will open to specify a location to save the settings file. If saving settings to your computer or USB device, you can also check the "Encrypt the configuration file with a password" box and enter a password to protect the file in the field underneath, if you wish.

<i>Restore Settings from USB</i>	
Restore Settings	Click the browse button to find a previously saved settings file on your computer or select a settings file from your USB device.

	<p>Settings files located on your USB storage will automatically be displayed. Then click “Restore” to replace your current settings. If your settings file is encrypted with a password, check the “Open file with password” box and enter the password in the field underneath.</p>
--	---------------------------------------------------------------------------------------------------------------------------------------------------------------------------------------------------------------------------------------------------------------------------------------

IV-5-4. Factory Default

> Factory Default

If the access point malfunctions or is not responding, then it is recommended that you reboot the device (see **IV-5.5**) or reset the device back to its factory default settings. You can reset the access point back to its default settings using this feature if the location of the access point is not convenient to access the reset button.

This will restore all settings to factory defaults.

Factory Default

Factory Default	Click “Factory Default” to restore settings to the factory default. A pop-up window will appear and ask you to confirm.
------------------------	-------------------------------------------------------------------------------------------------------------------------



After resetting to factory defaults, please wait for the access point to reset and restart.

IV-5-5. Reboot

> Reboot If the access point malfunctions or is not responding, then it is recommended that you reboot the device or reset the access point back to its factory default settings (see **IV-5-4**). You can reboot the access point remotely using this feature.

This will reboot the product. Your settings will not be changed. Click "Reboot" to reboot the product now.

Reboot

Reboot	Click "Reboot" to reboot the device. A countdown will indicate the progress of the reboot.
---------------	--------------------------------------------------------------------------------------------

V. Appendix

V-1. Configuring your IP address

The access point uses the default IP address **192.168.2.2**. In order to access the browser based configuration interface, you need to modify the IP address of your computer to be in the same IP address subnet e.g. **192.168.2.x (x = 3 – 254)**.

The procedure for modifying your IP address varies across different operating systems; please follow the guide appropriate for your operating system.

In the following examples we use the IP address **192.168.2.10** though you can use any IP address in the range **192.168.2.x (x = 3 – 254)**.

V-1-1. Windows XP

1. Click the “Start” button (it should be located in the lower-left corner of your computer), then click “Control Panel”. Double-click the “Network and Internet Connections” icon, click “Network Connections”, and then double-click “Local Area Connection”. The “Local Area Connection Status” window will then appear, click “Properties”.

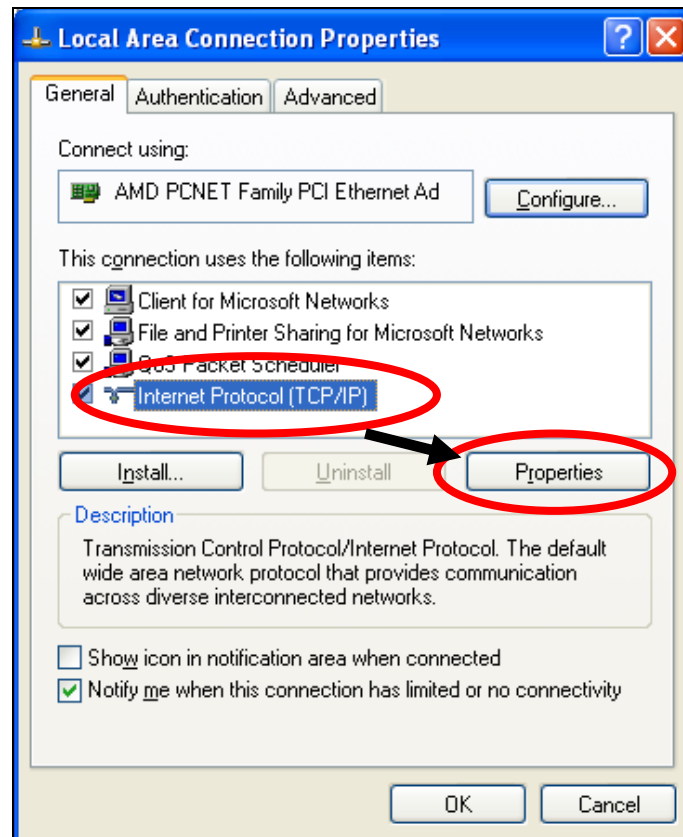

2. Select “Use the following IP address”, then input the following values:

IP address: 192.168.2.10

Subnet Mask: 255.255.255.0

Click ‘OK’ when finished.

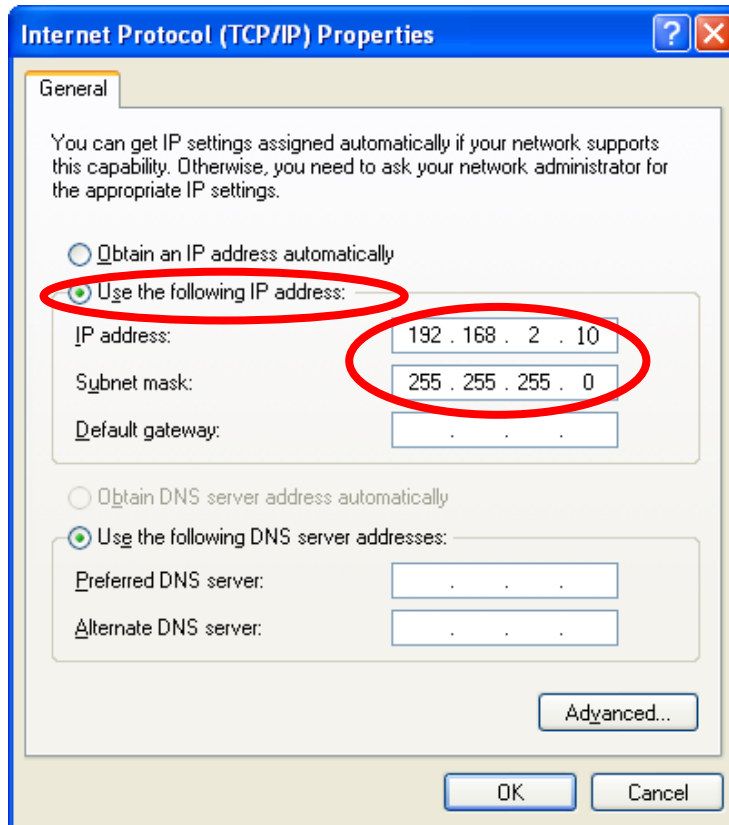

V-1-2. Windows Vista

1. Click the “Start” button (it should be located in the lower-left corner of your computer), then click “Control Panel”. Click “View Network Status and Tasks”, then click “Manage Network Connections”. Right-click “Local Area Network”, then select “Properties”. The “Local Area Connection Properties” window will then appear, select “Internet Protocol Version 4 (TCP / IPv4)”, and then click “Properties”.

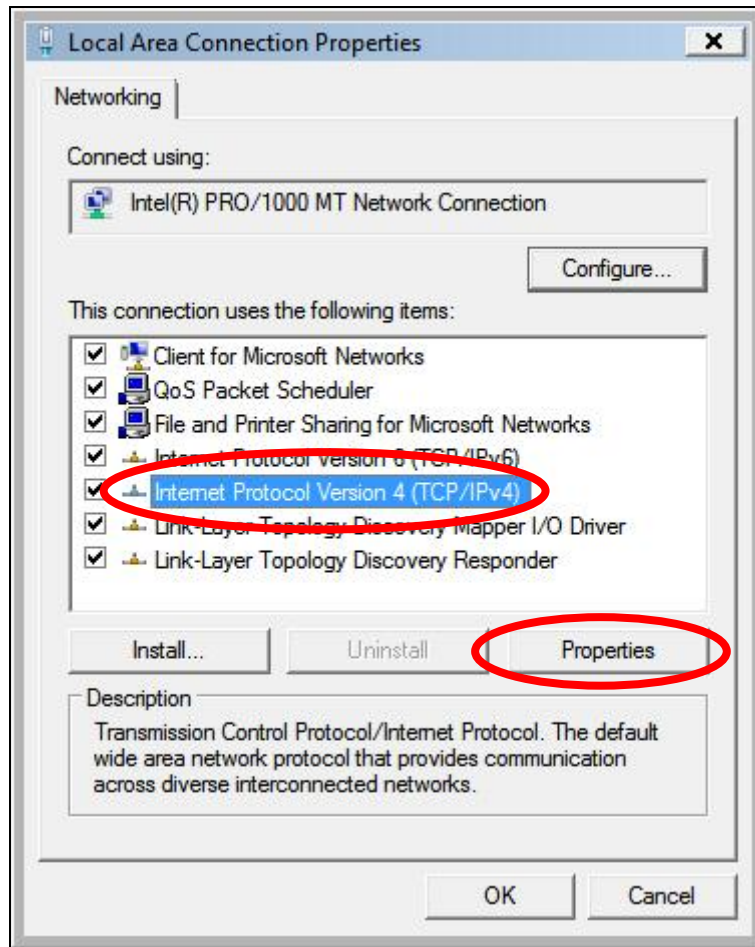

2. Select “Use the following IP address”, then input the following values:

IP address: 192.168.2.10

Subnet Mask: 255.255.255.0

Click ‘OK’ when finished.

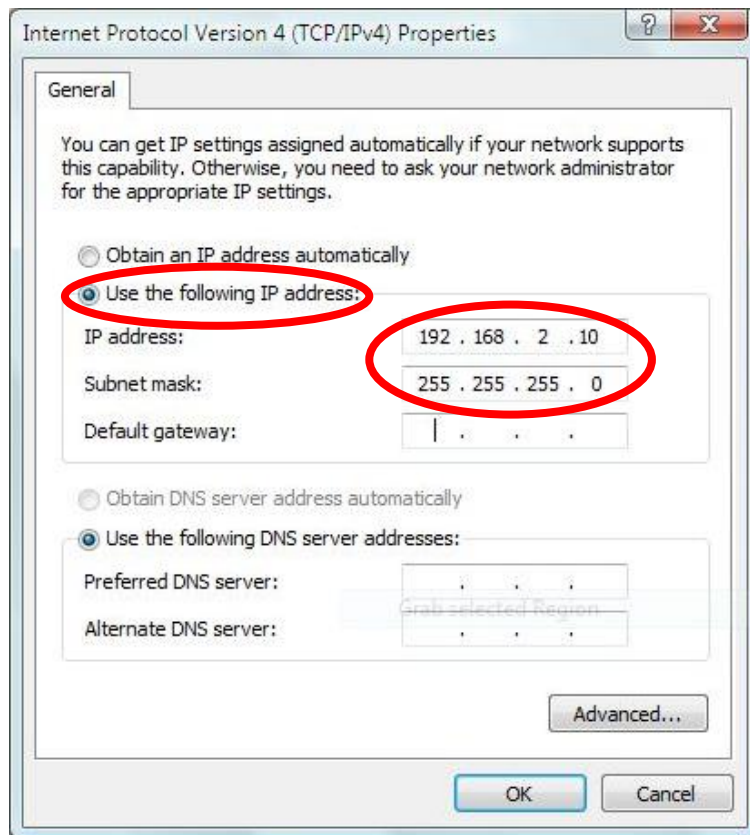

V-1-3. Windows 7

1. Click the “Start” button (it should be located in the lower-left corner of your computer), then click “Control Panel”.

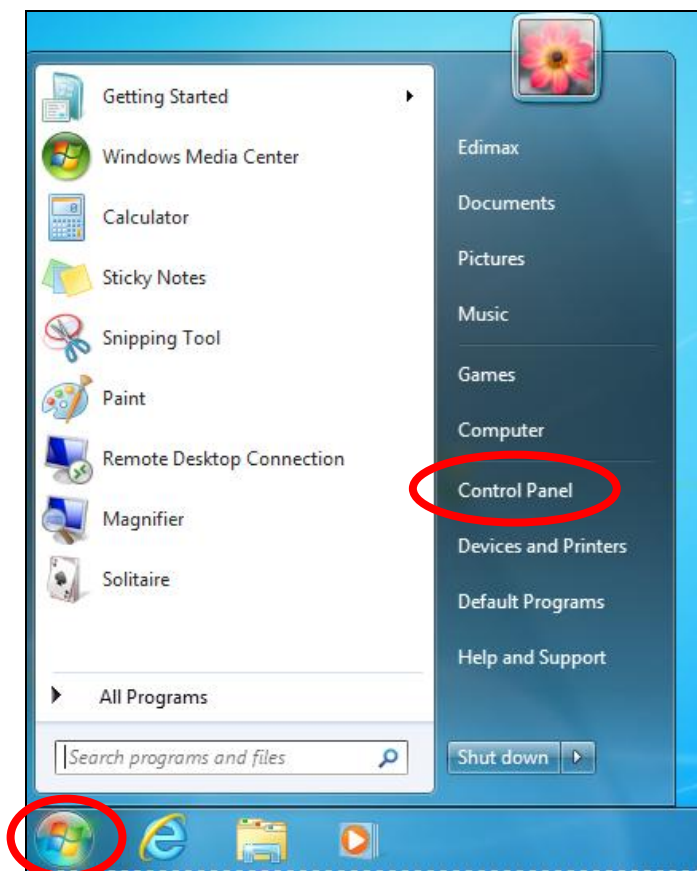

2. Under “Network and Internet” click “View network status and tasks”.

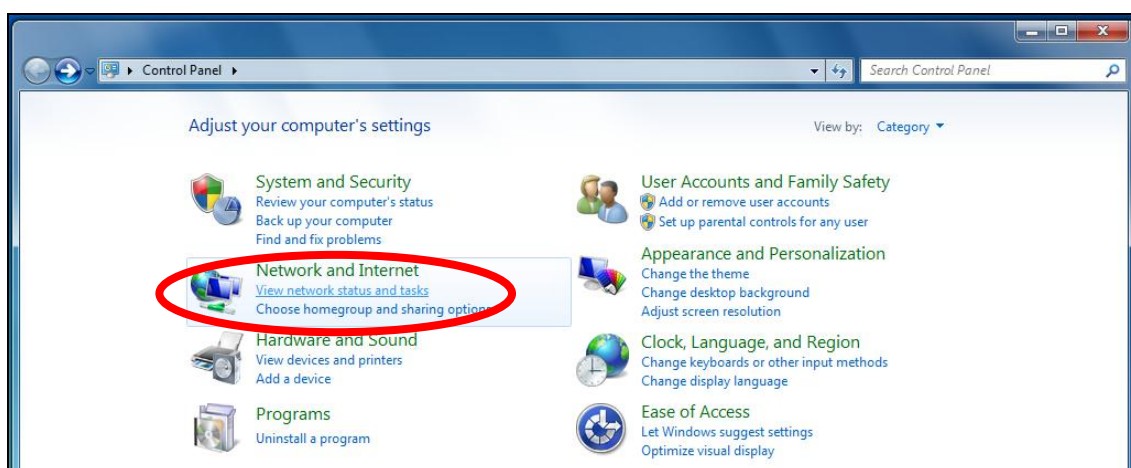

3. Click “Local Area Connection”.

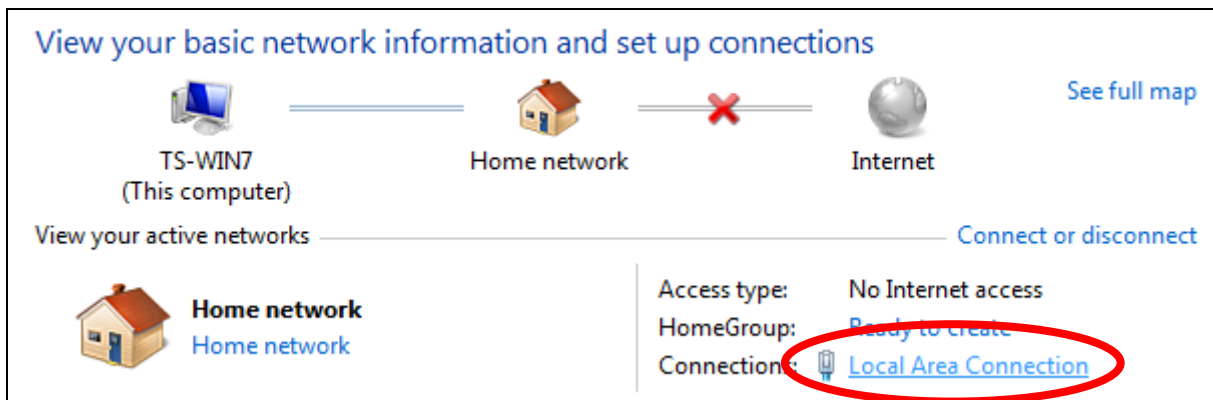

4. Click “Properties”.

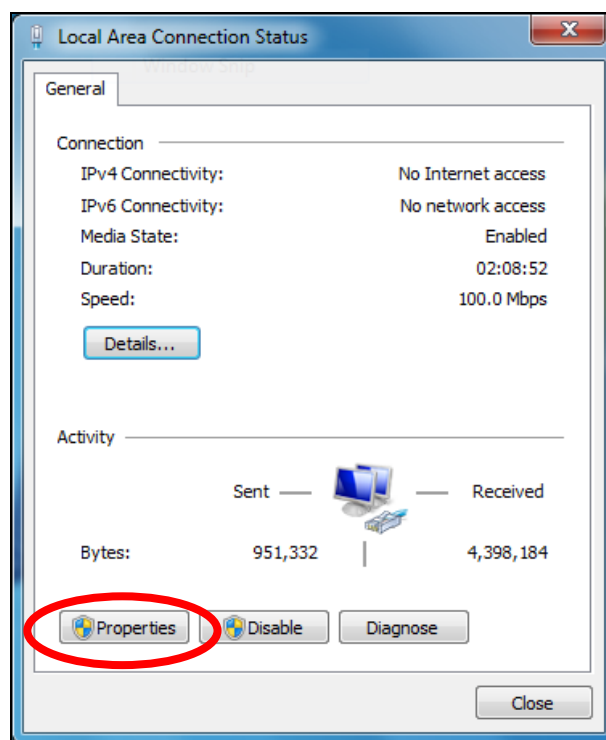

5. Select “Internet Protocol Version 4 (TCP/IPv4) and then click “Properties”.

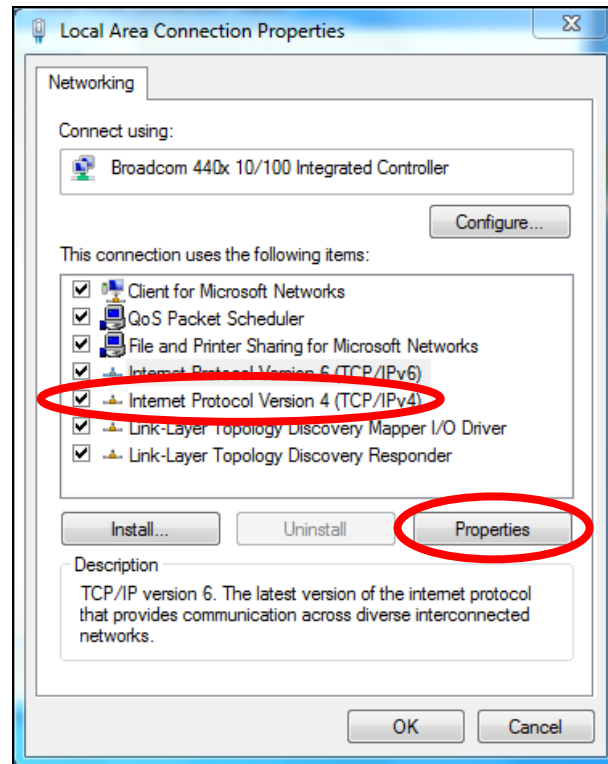

6. Select “Use the following IP address”, then input the following values:

IP address: 192.168.2.10

Subnet Mask: 255.255.255.0

Click ‘OK’ when finished.

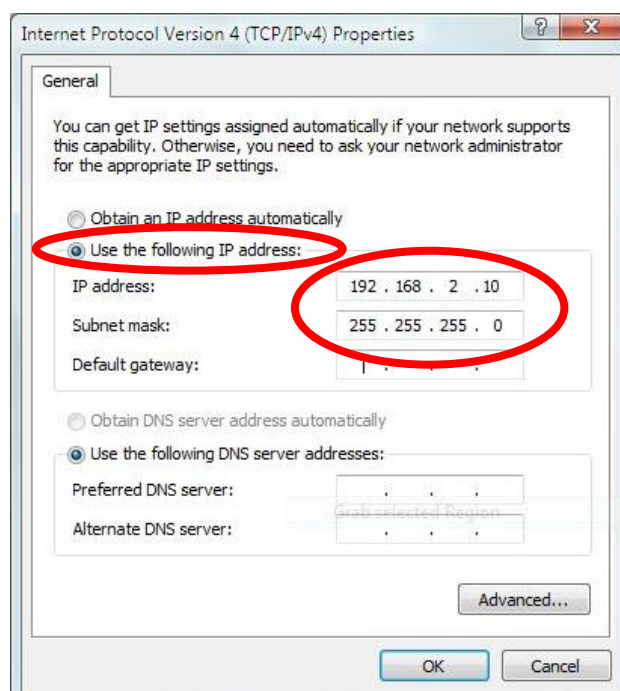

V-1-4. Windows 8

1. From the Windows 8 Start screen, you need to switch to desktop mode. Move your cursor to the bottom left of the screen and click.

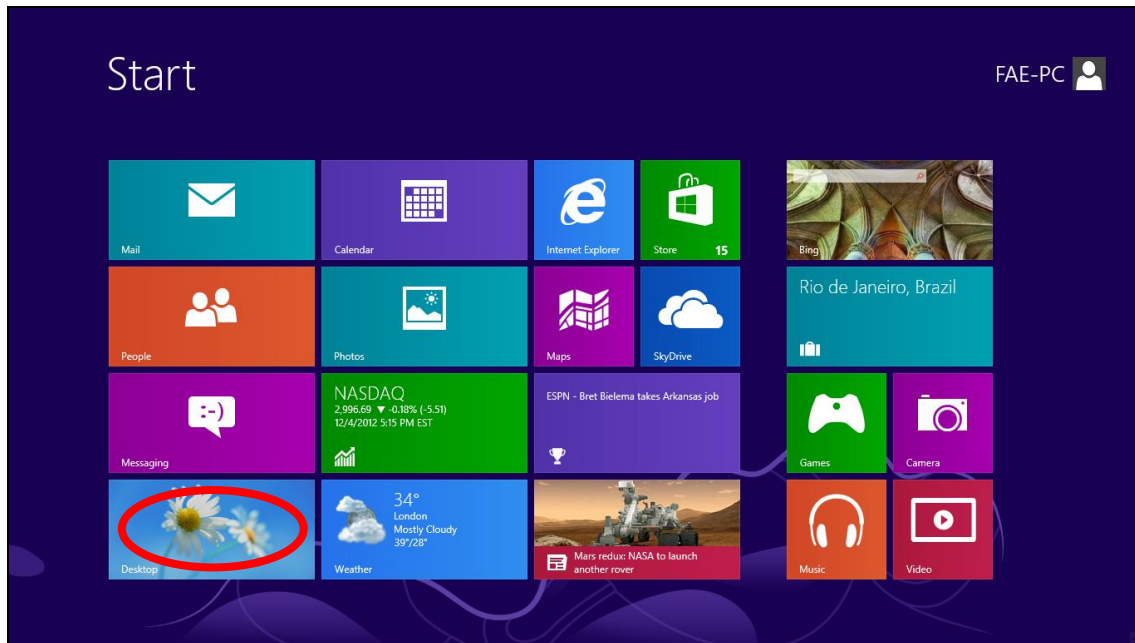

2. In desktop mode, click the File Explorer icon in the bottom left of the screen, as shown below.

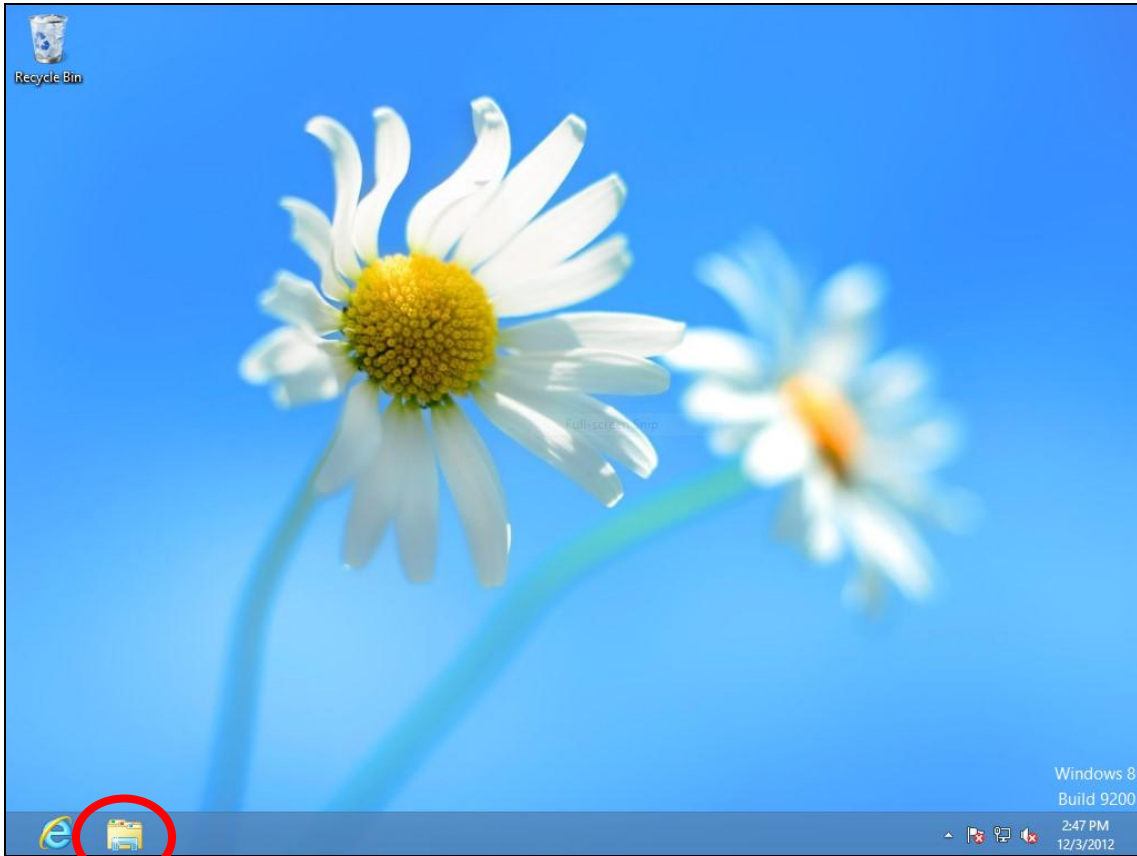

3. Right click “Network” and then select “Properties”.

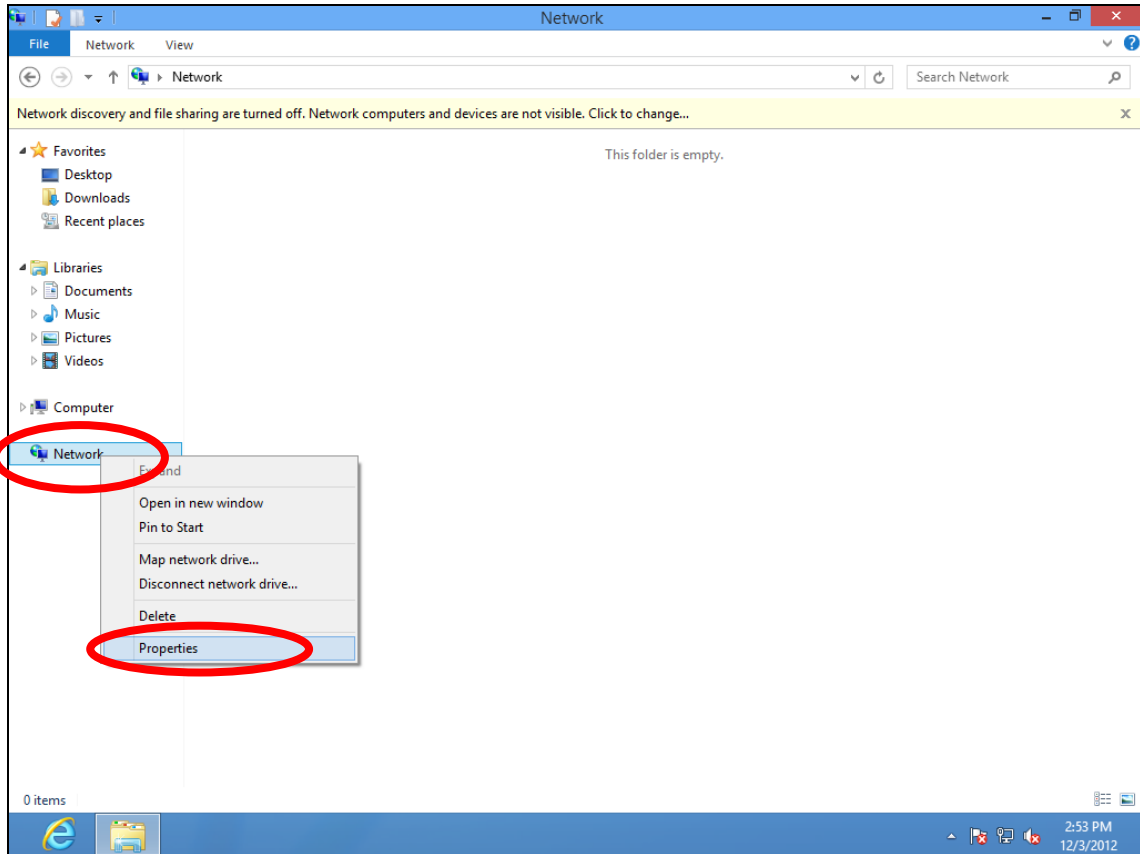

4. In the window that opens, select “Change adapter settings” from the left side.

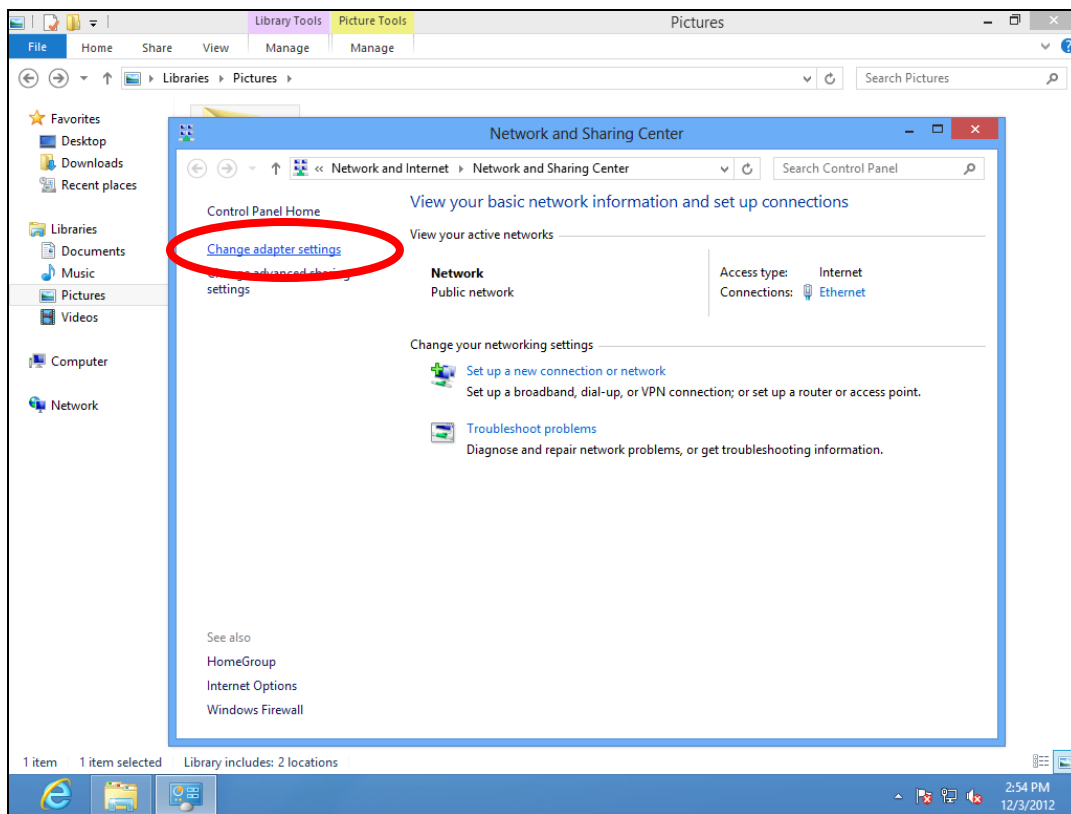

5. Choose your connection and right click, then select “Properties”.

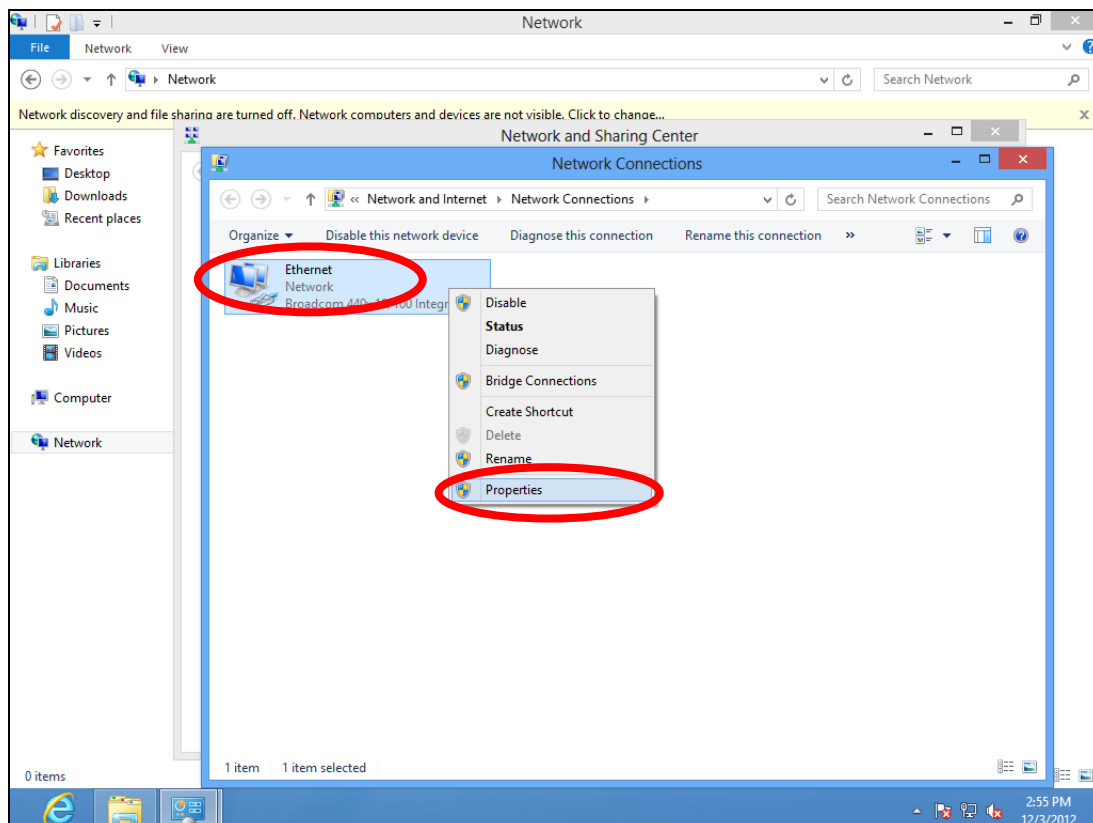

6. Select “Internet Protocol Version 4 (TCP/IPv4) and then click “Properties”.

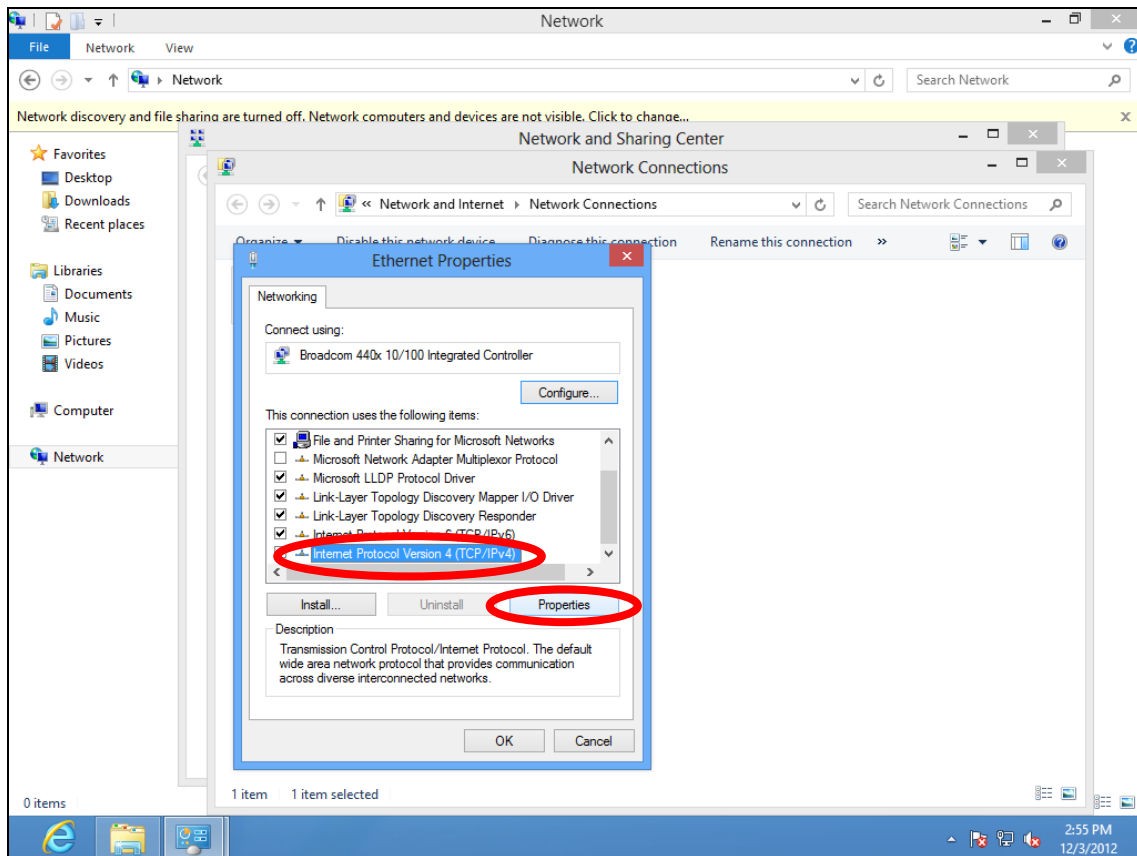

7. Select “Use the following IP address”, then input the following values:

IP address: 192.168.2.10

Subnet Mask: 255.255.255.0

Click ‘OK’ when finished.

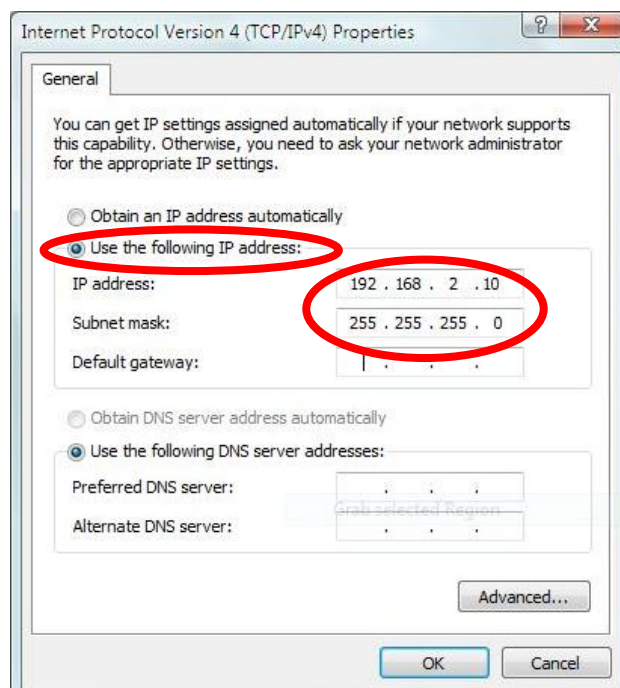

V-1-5. Mac

1. Have your Macintosh computer operate as usual, and click on “System Preferences”

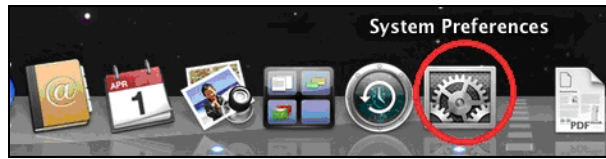

2. In System Preferences, click on “Network”.

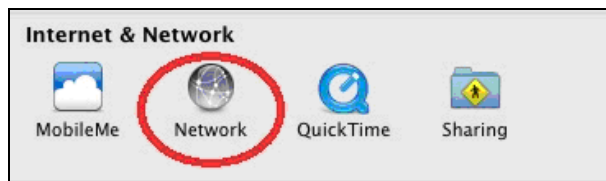

3. Click on “Ethernet” in the left panel.

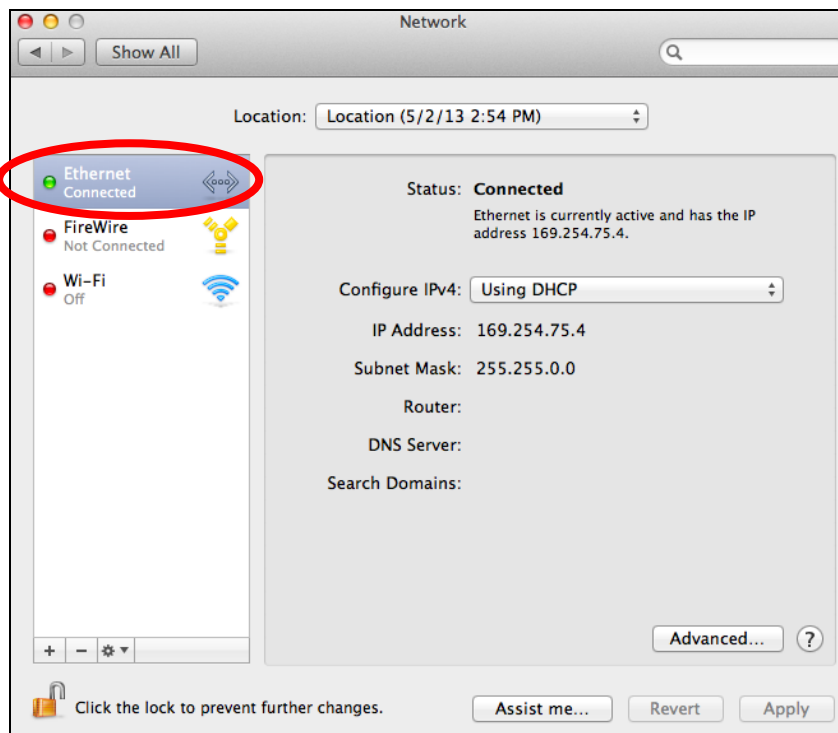

4. Open the drop-down menu labeled “Configure IPv4” and select “Manually”.

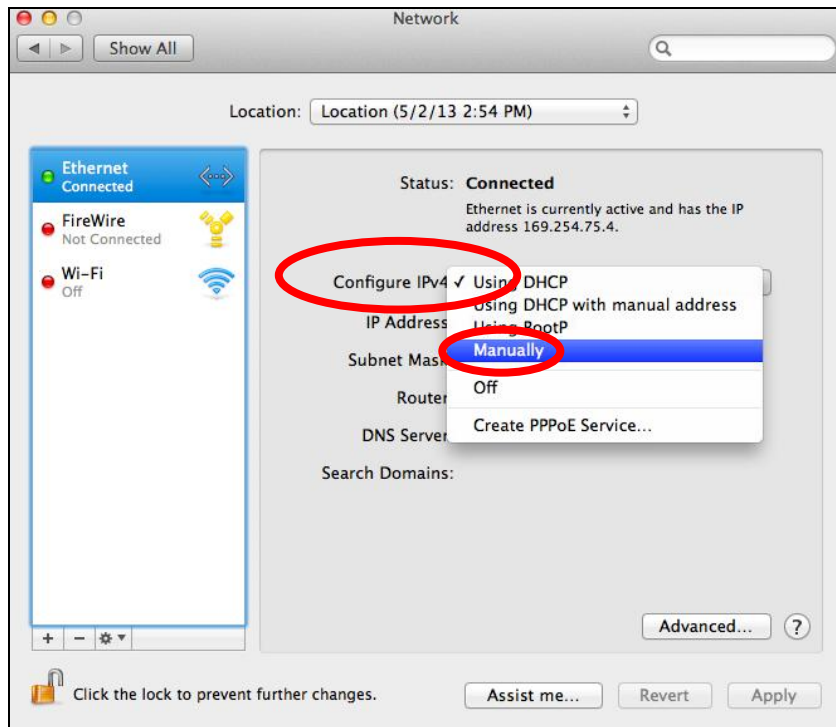

5. Enter the IP address 192.168.2.10 and subnet mask 255.255.255.0. Click on “Apply” to save the changes.

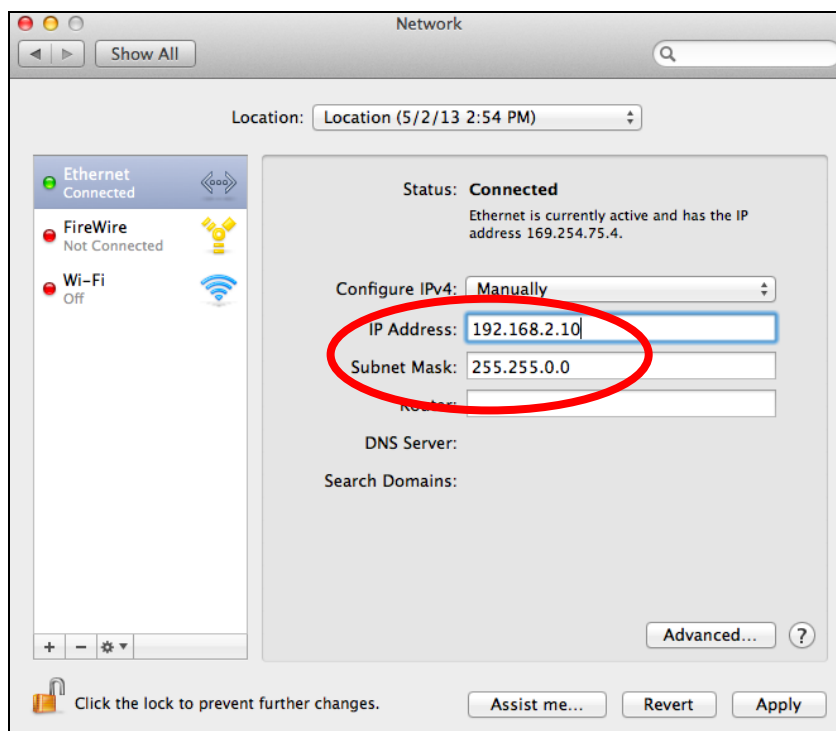

V-1-6. Glossary

Default Gateway (Access point): Every non-access point IP device needs to configure a default gateway's IP address. When the device sends out an IP packet, if the destination is not on the same network, the device has to send the packet to its default gateway, which will then send it out towards the destination.

DHCP: Dynamic Host Configuration Protocol. This protocol automatically gives every computer on your home network an IP address.

DNS Server IP Address: DNS stands for Domain Name System, which allows Internet servers to have a domain name (such as `www.Broadbandaccesspoint.com`) and one or more IP addresses (such as `192.34.45.8`). A DNS server keeps a database of Internet servers and their respective domain names and IP addresses, so that when a domain name is requested (as in typing "`Broadbandaccesspoint.com`" into your Internet browser), the user is sent to the proper IP address. The DNS server IP address used by the computers on your home network is the location of the DNS server your ISP has assigned to you.

DSL Modem: DSL stands for Digital Subscriber Line. A DSL modem uses your existing phone lines to transmit data at high speeds.

Ethernet: A standard for computer networks. Ethernet networks are connected by special cables and hubs, and move data around at up to 10/100 million bits per second (Mbps).

IP Address and Network (Subnet) Mask: IP stands for Internet Protocol. An IP address consists of a series of four numbers separated by periods, that identifies a single, unique Internet computer host in an IP network. Example: `192.168.2.1`. It consists of 2 portions: the IP network address, and the host identifier.

The IP address is a 32-bit binary pattern, which can be represented as four cascaded decimal numbers separated by ".": `aaa.aaa.aaa.aaa`, where each "aaa" can be anything from 000 to 255, or as four cascaded binary numbers separated by ".": `bbbbbbbb.bbbbbbbb.bbbbbbbb.bbbbbbbb`, where each "b" can either be 0 or 1.

A network mask is also a 32-bit binary pattern, and consists of consecutive leading 1's followed by consecutive trailing 0's, such as 11111111.11111111.11111111.00000000. Therefore sometimes a network mask can also be described simply as "x" number of leading 1's. When both are represented side by side in their binary forms, all bits in the IP address that correspond to 1's in the network mask become part of the IP network address, and the remaining bits correspond to the host ID.

For example, if the IP address for a device is, in its binary form, 11011001.10110000.10010000.00000111, and if its network mask is, 11111111.11111111.11110000.00000000 It means the device's network address is 11011001.10110000.10010000.00000000, and its host ID is, 00000000.00000000.00000000.00000111. This is a convenient and efficient method for access points to route IP packets to their destination.

ISP Gateway Address: (see ISP for definition). The ISP Gateway Address is an IP address for the Internet access point located at the ISP's office.

ISP: Internet Service Provider. An ISP is a business that provides connectivity to the Internet for individuals and other businesses or organizations.

LAN: Local Area Network. A LAN is a group of computers and devices connected together in a relatively small area (such as a house or an office). Your home network is considered a LAN.

MAC Address: MAC stands for Media Access Control. A MAC address is the hardware address of a device connected to a network. The MAC address is a unique identifier for a device with an Ethernet interface. It is comprised of two parts: 3 bytes of data that corresponds to the Manufacturer ID (unique for each manufacturer), plus 3 bytes that are often used as the product's serial number.

Access point: An access point is an intelligent network device that forwards packets between different networks based on network layer address information such as IP addresses.

Subnet Mask: A subnet mask, which may be a part of the TCP/IP information provided by your ISP, is a set of four numbers (e.g. 255.255.255.0) configured like an IP address. It is used to create IP address numbers used only within a

particular network (as opposed to valid IP address numbers recognized by the Internet, which must be assigned by InterNIC).

TCP/IP, UDP: Transmission Control Protocol/Internet Protocol (TCP/IP) and Unreliable Datagram Protocol (UDP). TCP/IP is the standard protocol for data transmission over the Internet. Both TCP and UDP are transport layer protocol. TCP performs proper error detection and error recovery, and thus is reliable. UDP on the other hand is not reliable. They both run on top of the IP (Internet Protocol), a network layer protocol.

Web-based management Graphical User Interface (GUI): Many devices support a graphical user interface that is based on the web browser. This means the user can use the familiar Netscape or Microsoft Internet Explorer to Control/configure or monitor the device being managed.

V-2. Hardware Specification

MCU/RF [↗]	Qualcomm <u>Atheros</u> QCA9558(2.4GHz) + QCA9880(5GHz)
PHY/Switch [↗]	Qualcomm <u>Atheros</u> AR8033 and AR8035
Memory [↗]	DDR2 128MB
Flash [↗]	16MB
Physical Interface [↗]	-LAN : 2 x 10/100/1000 Gigabit Ethernet with PoE support 802.3at (LAN 1) + 802.3af PSE Out (LAN 2, only available for 802.3at PSE input) [↗] - Reset Button -DC Power Jack
Power Requirement [↗]	Power over Ethernet, IEEE 802.3at DC : 12V / 2.5A
Antenna [↗]	Detachable Antenna x2
Others [↗]	Internal Buzzer (Find me)

V-3. ENVIRONMENT & PHYSICAL

Temperature Range	Operation : 0 to 50°C (32°F to 122°F) Storage : -20 to 60°C (-4°F to 140°F)
Humidity	90% or less – Operating, 90% or less - Storage
Certifications	FCC, CE
Dimensions	182mm (L) x 182mm (W) x 30mm (H)
Weight	470g
Package Content	1 x EW-7479WAC Access Point 2 x 2dBi SMA Antenna 1 x Power Adapter (12V / 2.5A) 1 x Wall Mount Screws Kit 1 x Wall Mount Screw Template 1 x Ethernet Cable

COPYRIGHT

Copyright ©2014 by this company. All rights reserved. No part of this publication may be reproduced, transmitted, transcribed, stored in a retrieval system, or translated into any language or computer language, in any form or by any means, electronic, mechanical, magnetic, optical, chemical, manual or otherwise, without the prior written permission of this company

This company makes no representations or warranties, either expressed or implied, with respect to the contents hereof and specifically disclaims any warranties, merchantability or fitness for any particular purpose. Any software described in this manual is sold or licensed "as is". Should the programs prove defective following their purchase, the buyer (and not this company, its distributor, or its dealer) assumes the entire cost of all necessary servicing, repair, and any incidental or consequential damages resulting from any defect in the software. Further, this company reserves the right to revise this publication and to make changes from time to time in the contents thereof without obligation to notify any person of such revision or changes.

Federal Communication Commission Interference Statement

This equipment has been tested and found to comply with the limits for a Class B digital device, pursuant to Part 15 of FCC Rules. These limits are designed to provide reasonable protection against harmful interference in a residential installation. This equipment generates, uses, and can radiate radio frequency energy and, if not installed and used in accordance with the instructions, may cause harmful interference to radio communications. However, there is no guarantee that interference will not occur in a particular installation. If this equipment does cause harmful interference to radio or television reception, which can be determined by turning the equipment off and on, the user is encouraged to try to correct the interference by one or more of the following measures:

1. Reorient or relocate the receiving antenna.
2. Increase the separation between the equipment and receiver.
3. Connect the equipment into an outlet on a circuit different from that to which the receiver is connected.
4. Consult the dealer or an experienced radio technician for help.

FCC Caution

This device and its antenna must not be co-located or operating in conjunction with any other antenna or transmitter. This device complies with Part 15 of the FCC Rules. Operation is subject to the following two conditions: (1) this device may not cause harmful interference, and (2) this device must accept any interference received, including interference that may cause undesired operation. Any changes or modifications not expressly approved by the party responsible for compliance could void the authority to operate equipment.

Federal Communications Commission (FCC) Radiation Exposure Statement

This equipment complies with FCC radiation exposure limits set forth for an uncontrolled environment. This equipment should be installed and operated with minimum distance 20cm between the radiator & your body.

Operations in the 5.15-5.25GHz band are restricted to indoor usage only.

Any changes or modifications not expressly approved by the party responsible for compliance could void the user's authority to operate this equipment.

This transmitter must not be co-located or operating in conjunction with any other antenna or transmitter.

R&TTE Compliance Statement

This equipment complies with all the requirements of DIRECTIVE 1999/5/EC OF THE EUROPEAN PARLIAMENT AND THE COUNCIL of March 9, 1999 on radio equipment and telecommunication terminal equipment and the mutual recognition of their conformity (R&TTE). The R&TTE Directive repeals and replaces in the directive 98/13/EEC (Telecommunications Terminal Equipment and Satellite Earth Station Equipment) As of April 8, 2000.

Safety

This equipment is designed with the utmost care for the safety of those who install and use it. However, special attention must be paid to the dangers of electric shock and static electricity when working with electrical equipment. All guidelines of this and of the computer manufacture must therefore be allowed at all times to ensure the safe use of the equipment.

EU Countries Intended for Use

The ETSI version of this device is intended for home and office use in Austria, Belgium, Bulgaria, Cyprus, Czech, Denmark, Estonia, Finland, France, Germany, Greece, Hungary, Ireland, Italy, Latvia, Lithuania, Luxembourg, Malta, Netherlands, Poland, Portugal, Romania, Slovakia, Slovenia, Spain, Sweden, Turkey, and United Kingdom. The ETSI version of this device is also authorized for use in EFTA member states: Iceland, Liechtenstein, Norway, and Switzerland.

EU Countries Not Intended for Use

None