



Bontrager RIDEtime Elite Computer plus Duo Trap S Sensor

www.bontrager.com

PN 580968

Parts list

RIDEtime Elite Computer

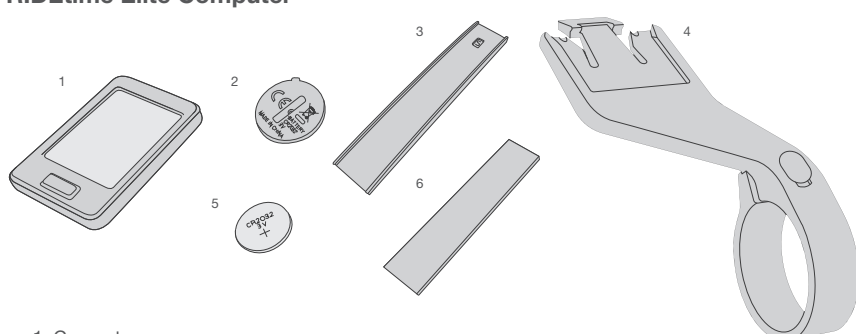

1. Computer
2. Battery cover
3. 31.8mm handlebar shim
4. Out front mount
5. CR2032 battery
6. 22.2, 25.4 & 26.0mm handlebar shim

Install battery

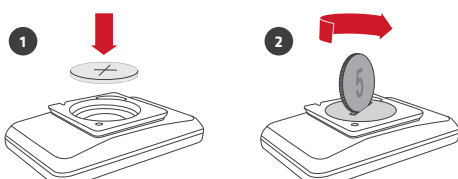

Install computer mount

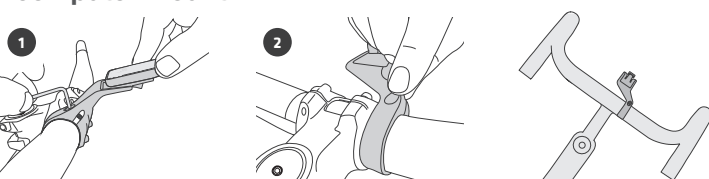

1. Shim use: Determine the diameter of your handlebar.
 - Use the thin shim with a 31.8mm handlebar.
 - Use the thick shim with a 25.4 or 26.0mm handlebar.
 - Use no shims with a 35mm handlebar.
 - Use both shims with a 22.2mm handlebar.
 2. Remove the rubber cover over the mounting clamp bolt.
 3. Use a 2.5mm hex wrench to torque the bolt to 0.8 N·m (7 in·lb).
 4. Replace the rubber cover over the clamp bolt.
- NOTE:** The mount is not to be used with a cell phone.

Mount computer

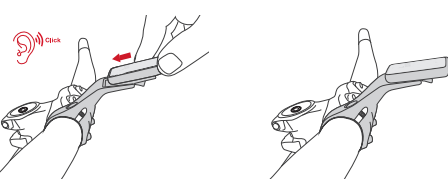

Understanding the instructions

Button location	Quick press	Multi press	Long press (2 seconds)
Front			
Rear			

- The letters indicate the order in which to push the buttons.
- More than one arrow means you should push the button until you see the value you want.
- Press and hold until next digit flashes to switch to next digit or field.



Selection note:
Gray color represents flashing characters that show selected value.

Shows number of digits to be set.

Screen icon	Description
	Speed sensor is connected. Flashing if searching for sensor.
	Cadence sensor is connected. Flashing if searching.
	Heart rate monitor is connected. Flashing if searching.
	Power meter is connected. Flashing if searching.
	A service interval has been reached. Flashing is a prompt to clear.
	Transmitter signal when connected to compatible lights. Flashing if searching.
	Battery life is sufficient. Replacement when only 1/3 indicated.

Enter and exit setup modes

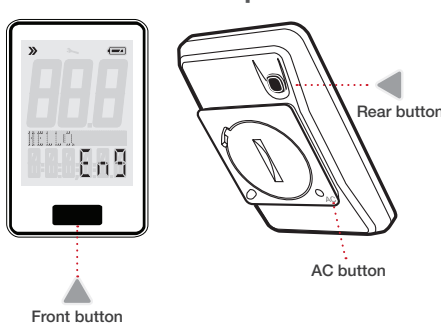

Rear button

- Press the rear button once to enter Primary setup.
- Press and hold the rear button 5 seconds to enter Pairing and Advanced setup.
- Press the rear button for 5 seconds to exit either setup mode.
- In Ride mode you can press the rear button for 5 seconds to return you to the beginning of the Primary setup without changing any previously entered settings.

NOTE: Do not use the rear button while riding. It will restart setup mode.

AC button

- Press the AC button for a "hard reset" to return the computer to the factory default settings.

Front button

- Press the front button to scroll through the screens to find your desired setting.

Primary setup

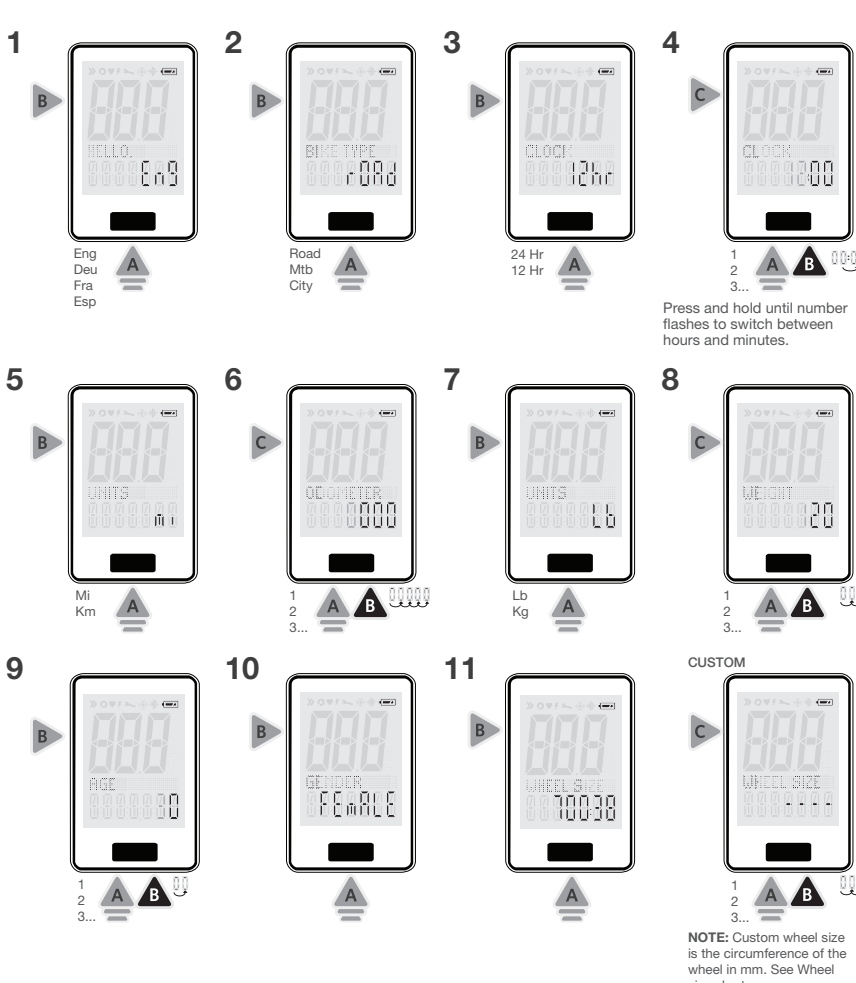

NOTE: Custom wheel size is the circumference of the wheel in mm. See Wheel size chart.

Road		Mountain		City	
Size	Code	Size	Code	Size	Code
700:23*	2124	29:2.2*	2340	700:28*	2164
700:25	2136	29:2.3 (2.35)	2359	700:32	2190
700:28	2164	29:3.0	2413	700:35	2209
700:32	2190	27.5:2.2	2221	700:38	2227
700:35	2209	27.5:2.4	2253	700:40	2240
700:38	2227	27.5:2.8	2309	700:42	2253
700:40	2240	27.5:3.8	2400	700:45	2271
700:42	2253	27.5:4.5	2485	26:2.0	2117
700:45	2271	26:2.0	2117	26:2.2	2148
Custom	001-2999	26:2.2	2148	Custom	01-2999
		26:3.8	2322		
		26:4.7	2403		
		Custom	01-2999		

*Default

About this product

WARNING

When riding your bicycle, do not stare at the computer for a long time. If you do not watch the road, you could hit an obstacle which might cause you to lose control, fall, and cause injury.

IMPORTANT: To use the RIDEtime Elite computer, you must have an ANT+ compatible speed, cadence, or power sensor mounted on your bicycle.

Compatible sensors:

- Bontrager Duo Trap – PN 508126
- Bontrager Duo Trap S – PN 437960
- Bontrager Interchange Combo – PN 438482
- Bontrager ANT+/BLE Softstrap Heart Rate Belt Kit – PN 519606
- Other ANT+ compatible sensor

To set up any other sensor, please refer to the manual that came with your sensor.

Duo Trap S

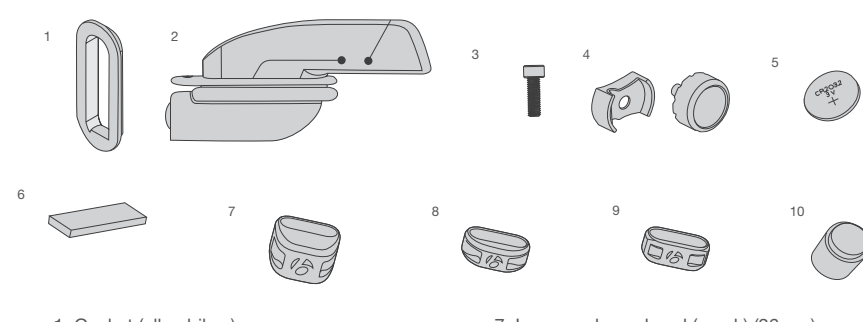

1. Gasket (alloy bikes)
2. Sensor with grommet and 2mm spacer installed (carbon bikes)
3. 8mm bike mounting screw
4. Speed magnet (wheel)
5. CR2032 battery
6. Cadence band shim
7. Large cadence band (crank) (26mm) W519998
8. Small cadence band with magnet (crank) (9mm) W519999
9. Xsmall cadence band with magnet (crank) (4mm) W534154
10. Plug (large cadence band)

Install battery

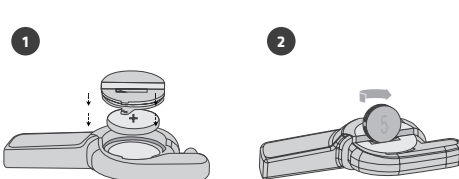

Install Duo Trap S sensor (alloy bikes)

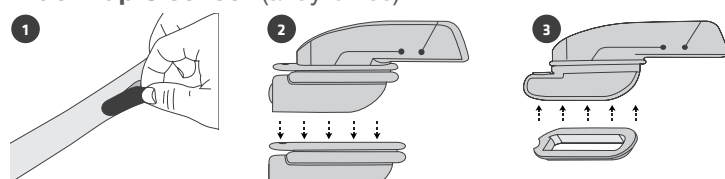

1. Remove the Duo Trap S cover from the chainstay.
2. Remove the grommet from the sensor.
3. Install the gasket onto the sensor with the notch facing forward as shown.

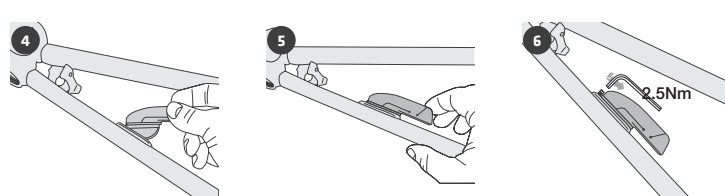

4. Install the sensor and gasket into the chainstay.
5. Hold the sensor into place and install the 8mm screw.
6. Use a 2.5mm hex tool to tighten the sensor.

Install Duo Trap S sensor (carbon bikes)

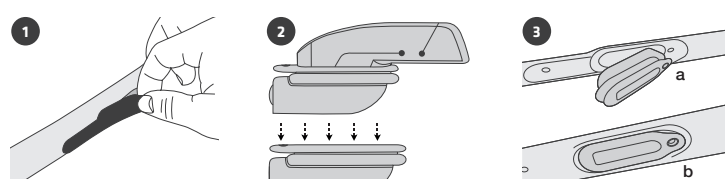

1. Remove the Duo Trap S cover from the chainstay.
2. Remove the grommet from the sensor.
3. Fully insert the grommet into the chainstay. Make sure the grommet is flush with the chainstay.

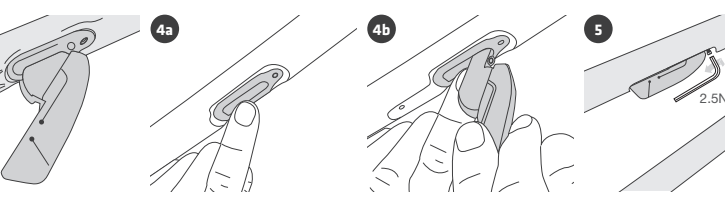

4. Install the sensor into the grommet in the chainstay.
- HINT:** Hold the grommet in place with one hand and insert the sensor with the other hand as shown.
5. Hold the sensor in place and use a 2.5mm hex to install and tighten the 8mm screw.

NOTE: Make sure the 2mm spacer is installed in the grommet before you tighten the screw.

Mount speed magnet

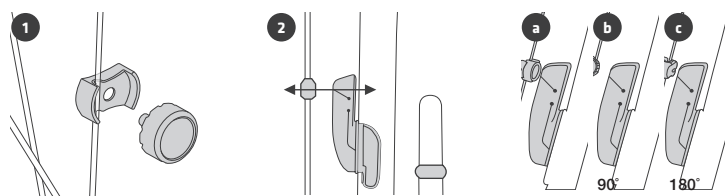

1. Tighten the speed magnet on a spoke
2. Align the speed magnet with the marking on the sensor.
3. If necessary, rotate the magnet 90° or 180° to achieve sensor clearance.
4. **Rotate the wheel and look for a red LED in the sensor to verify the magnet and sensor are in alignment.**

NOTE: The LED will illuminate for the first 10 revolutions only.

Install small cadence magnet

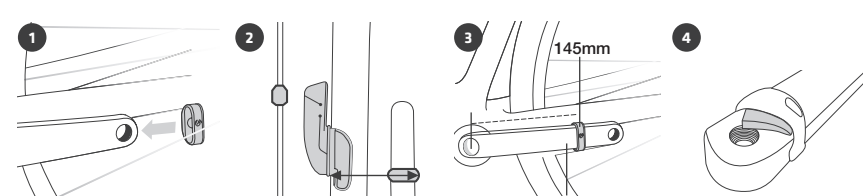

1. Remove the non driveside pedal and install the small cadence magnet on the crank arm with the thick side nearest to the chainstay.
2. Align the magnet with the sensor.
 - Alloy bikes: Align the magnet with the line on the sensor.
 - Carbon bikes: Place the magnet 135mm or 145mm from the center of the bottom bracket to the center of the magnet
3. Rotate the crank backwards. Look for the green LED on the cadence sensor to verify the magnet is correctly aligned.

NOTE: The LED will illuminate for the first 10 revolutions only.

4. Optional: If the magnet is aligned but the LED does not illuminate, place a cadence band shim underneath the appropriate magnet.
5. If the small band does not fit between the crank and the chainstay, use the XS (4mm) cadence band provided.

Install large cadence magnet

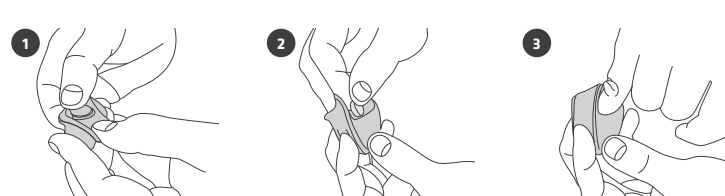

1. Remove the plastic cap from inside the small cadence band.
2. Remove the magnet from inside the small cadence band.
3. Insert the magnet fully inside the large cadence band so it is flush against the inside of the cavity.

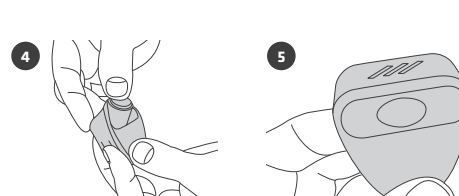

4. Insert the plastic plug into the cavity of the large cadence band to hold the magnet in place.
5. Follow the steps in the Small cadence magnet installation to complete this installation.

Measure your wheel size

1. With the valve stem of the wheel directly over the floor, mark the floor at the valve stem.
2. Roll the bike forward one revolution of the wheel so that the valve stem is again directly over the floor.
3. Mark the new location of the valve stem.
4. Measure the distance between the marks. Measurements in mm are required.

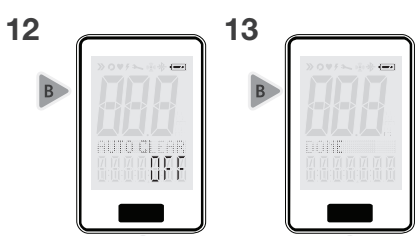
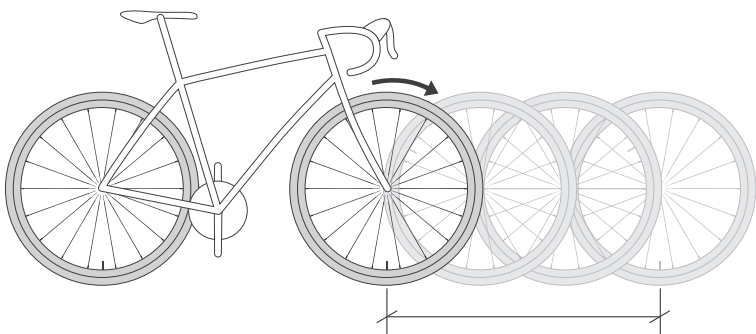

NOTE: If you have no paired sensors, you'll be taken to Pairing and Advanced setup upon completion of Primary setup.

NOTE: When Auto Clear is set, the number represents the amount of inactive time before the last ride's data is cleared.

Pairing and Advanced setup

Pairing

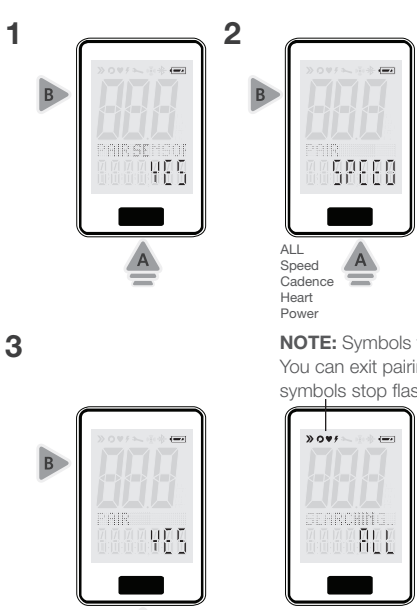

NOTES:

1. If you select ALL, the computer will look to pair all nearby devices. If you want to look for a specific type of sensor (speed, cadence, heart rate, or power) then select that choice.
2. If you want to pair more than one sensor but not all, pair one sensor at a time. Repeat the procedure for each sensor.
3. To exit and advance to the Pair lights step, press the rear button.

Power meter calibration (If power meter sensor is not paired, computer will advance to step 5.)

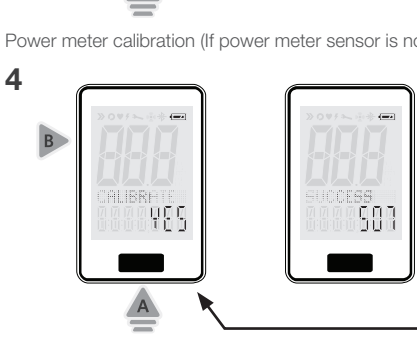

Follow the power meter guidelines to calibrate your power meter for the most accurate reading.

Pair lights

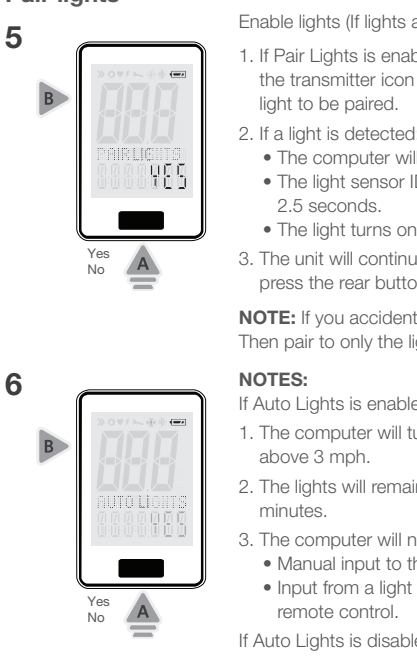

Enable lights (If lights are not paired, computer will advance to step 6.)

1. If Pair Lights is enabled (YES), the computer will enter search mode, and the transmitter icon (+) will flash. Hold the computer close to the desired light to be paired.
2. If a light is detected:
 - The computer will display FOUND.
 - The light sensor ID and the transmitter icon will display for 2.5 seconds.
 - The light turns on for 2.5 seconds, then turns off.
3. The unit will continue to search for up to three lights. To exit the search, press the rear button.

NOTE: If you accidentally pair a light, press the AC button to delete all lights. Then pair to only the lights desired.

NOTES:

If Auto Lights is enabled (YES):

1. The computer will turn your paired light(s) on when speed is detected above 3 mph.
2. The lights will remain on until speed drops below 1 mph for longer than 3 minutes.
3. The computer will not override:
 - Manual input to the lights.
 - Input from a light pairing with another computer or a remote control.

If Auto Lights is disabled (NO):

4. The paired light(s) will remain stored as saved connections.

5. The computer does not try to form a connection with the lights.

There are three occurrences when a command is sent to the lights to change their settings:

- Turn ON when speed above 3 mph is detected.
- Turn OFF when speed below 1 mph is detected for longer than 3 minutes.
- Change mode when Night mode state is changed.

Light setting

NOTES:

1. The computer should turn the lights ON to the appropriate mode based on whether Night Mode is enabled or disabled.
2. See light mode table in Night mode section.
3. In ride mode, if the battery level of a connected light reaches critically low, the transmitter icon will flash and the display will flash LOW BATTERY LIGHTS (low batt!) in the middle display and LIGHTS in the lower display).

Low battery detection

In ride mode, if the battery level reaches critically low:

- The transmitter icon will flash continuously and the display will show LOW BATTERY LIGHTS for 2.5 seconds.
- The LOW BATTERY LIGHTS message will be repeated every 30 seconds.

Display

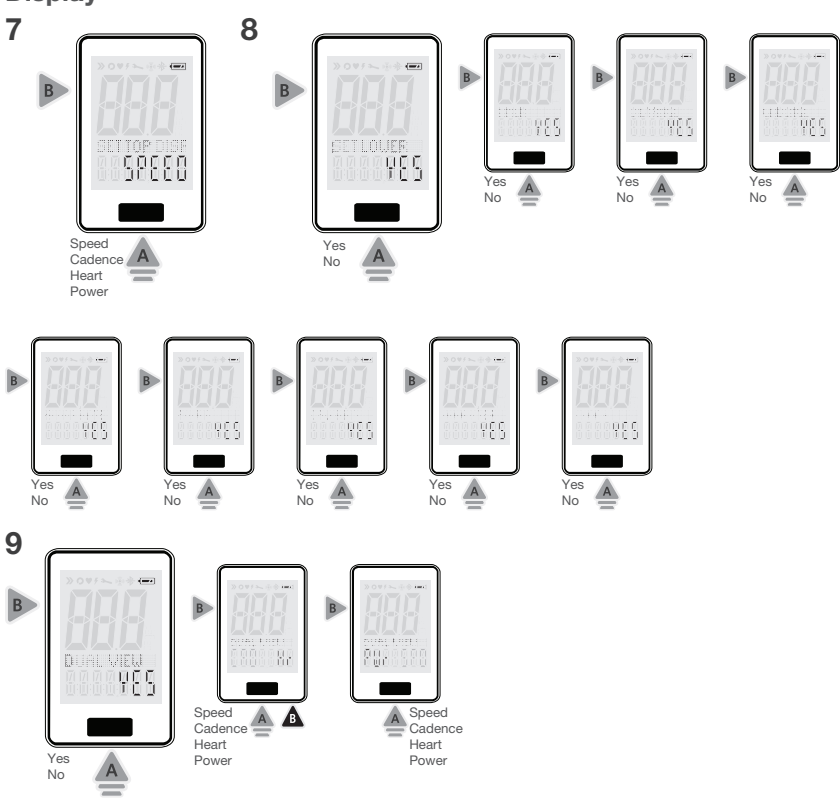

NOTES:

- These screens will be displayed only if Dual View was selected (YES) in step 9.
- If NO is selected in any of the display screens in step 8, that metric will not be available in the Scan display.

Display customization

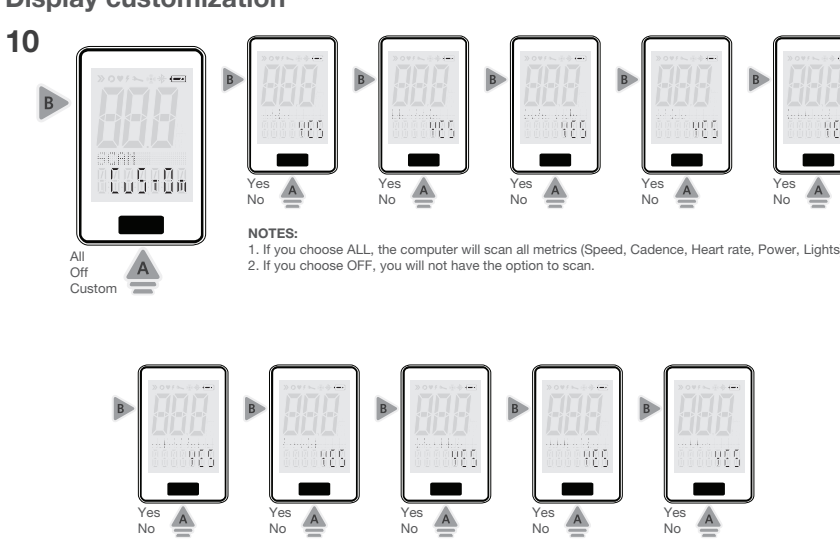

NOTE: Sensors disabled during step 10 will not show either the instantaneous screen or the AVG/MAX screen.

Ride mode

To wake the computer: Push any button or spin the wheel.

The default Ride mode is shown with all sensors connected, and Speed is selected as the primary metric. Sensors that are not connected or that are disabled will not be displayed and will be skipped.

The computer will turn off after 10 minutes of inactivity.

NOTE: If you do not have a speed sensor, the timer will still run if you have a cadence sensor or power meter.



To reset the timer, hold down the front button for 5 seconds from any Ride mode screen.

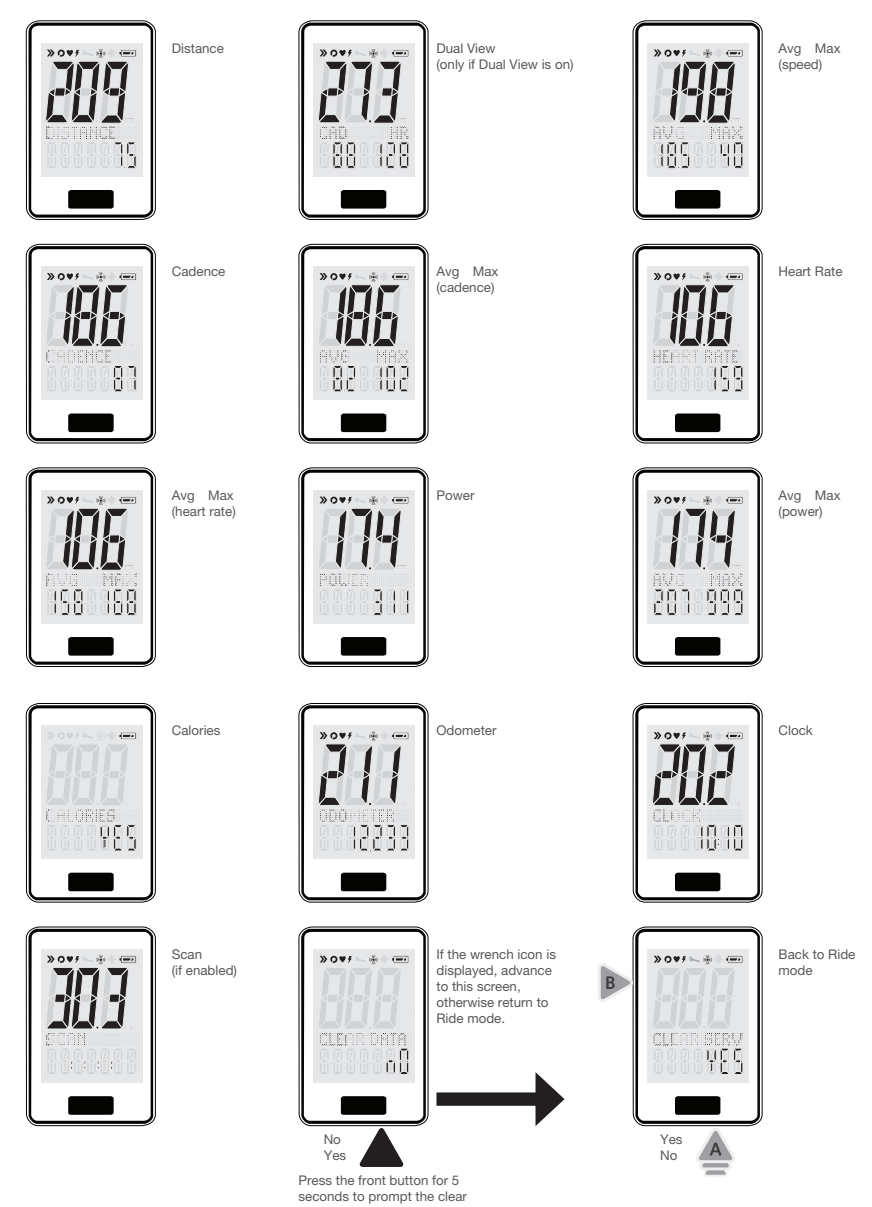

Night mode

Press the front button for 10 seconds to prompt the Night mode OFF/ON question.

- Night mode will enable the backlight.
- In Night mode, the first button press activates the backlight for 5 seconds and does not advance the carousel.
- Each additional press extends the backlight for 5 seconds, and advances the carousel.
- When Night mode is OFF, the backlight is disabled.
- If lights are connected, Night Mode setting will determine Light Mode.

When paired with Bontrager lights, the following table shows what mode the lights are in:

	Night Mode ON	Night Mode OFF
Headlight	Medium steady	Day flash
Taillight	Night flash	Day flash

Trek Bicycle Corporation

Contact information:

North America
Trek Bicycle Corporation
801 West Madison Street
Waterloo, WI 53594
Tel: 800-313-8735

Europe
Bikeurope BV
Ceintuurbaan 2-20C
3847 LG Harderwijk
The Netherlands
Tel: +31 (0)33 45 09 060

Statements of regulatory compliance

FCC Compliance

RIDEtime Elite Computer – FCC ID: O4GRTELITE
IC: 7666A-RTELITE

Duo Trap S – FCC ID: O4DUOTRAPS
IC: 7666A-DUOTRAPS

Transmission Frequency: 2.4GHz
Bluetooth: 2402MHz ~ 2480MHz
ANT+: 2457MHz
Bluetooth Max Power: <6dBm
ANT+ Max Power: <6dBm
Operating power: 3 V D.C.
Operating temperature: 0°C–50°C
RF exposure compliance distance is 20 millimeters.

These devices comply with part 15 of the FCC Rules.

Operation is subject to the following conditions: (1) this device may not cause harmful interference, and (2) this device must accept any interference received, including interference that may cause undesired operation.

NOTE: This equipment has been tested and found to comply with the limits for a Class B digital device, pursuant to Part 15 of the FCC Rules. These limits are designed to provide reasonable protection against harmful interference in a residential installation. This equipment generates uses and can radiate radio frequency energy and, if not installed and used in accordance with the instructions, may cause harmful interference to radio communications. However, there is no guarantee that interference will not occur in a particular installation.

If this equipment does cause harmful interference to radio or television reception, which can be determined by turning the equipment off and on, the user is encouraged to try to correct the interference by one or more of the following measures:

- Reorient or relocate the receiving antenna.
- Increase the separation between the equipment and receiver.
- Connect the equipment into an outlet on a circuit different from that to which the receiver is connected.
- Consult the dealer or experienced radio / TV technician for help.

CAUTION: Any changes or modifications not expressly approved by Trek Bicycle Corporation could void the user's authority to operate the equipment.

NOTE: TREK BICYCLE CORPORATION IS NOT RESPONSIBLE FOR ANY RADIO OR TV INTERFERENCE CAUSED BY UNAUTHORIZED MODIFICATIONS TO THIS EQUIPMENT.

Industry Canada Compliance

This device complies with Industry Canada license-exempt RSS standard(s). Operation is subject to the following two conditions: (1) this device may not cause interference, and (2) this device must accept any interference, including interference that may cause undesired operation of the device.

Léprésent appareil est conforme aux CNR d'Industrie Canada applicable aux appareils radio. Exempt de licence. L'exploitation est autorisée aux deux conditions suivantes: (1) l'appareil ne doit pas produire de brouillage, et (2) l'utilisateur de l'appareil doit accepter tout brouillage radioélectrique subi, même si le brouillage est susceptible d'en compromettre le fonctionnement.

This Bontrager equipment complies with FCC and IC radiation exposure limits set forth for an uncontrolled environment. The radiated output power of the Transmitt Wireless Device is below the Industry Canada (IC) radio frequency exposure limits. This transmitter must not be co-located or operating in conjunction with any other antenna or transmitter.

Status of the listing in the Industry Canada's REL (Radio Equipment List) can be found at the following web address: <http://www.ic.gc.ca/app/sitt/reitel/srch/nwRdSrch.do?lang=eng>

Additional Canadian information on RF exposure also can be found at the following web address: <http://www.ic.gc.ca/eic/site/smt-gst.nsf/eng/sf08792.html>

Cet appareil est conforme aux limites d'exposition à la fréquence radio (FR) d'IC et de FCC. La puissance de sortie émise par l'appareil de sans fil Transmitt est inférieure à la limite d'exposition aux fréquences radio d'Industrie Canada (IC). Cet appareil est en contact direct avec l'utilisateur dans des conditions normales d'utilisation. L'émetteur ne doit pas être co-implémenté ou utilisé conjointement avec une autre antenne ou un autre émetteur.

Ce périphérique est homologué pour l'utilisation au Canada. Pour consulter l'entrée correspondant à l'appareil dans la liste d'équipement radio (REL - Radio Equipment List) d'Industrie Canada rendezvous sur: <http://www.ic.gc.ca/app/sitt/reitel/srch/nwRdSrch.do?lang=fra> Pour des informations supplémentaires concernant l'exposition aux RF au Canada rendezvous sur: <http://www.ic.gc.ca/eic/site/smt-gst.nsf/eng/sf08792.html>

European Union Compliance

Trek Bicycle Corporation and Bontrager hereby declare that the wireless devices identified as RIDEtime Elite Computer and Duo Trap S Sensor are in compliance with the following European Directives:

- RED 2014/53/EU
- EMCD 2014/30/EU
- LVD 2014/35/EU
- RoSH Directive 2011/65/EU

The full text of the EU declaration of conformity is available from your bike shop, or at the following internet address: <http://www.bontrager.com/support>