



DCY

450 MHz RTK

OPERATOR'S MANUAL

450 MHz RTK

OMPFP10070 ISSUE A0 (ENGLISH)

CALIFORNIA

Proposition 65 Warning

Diesel engine exhaust and some of its constituents are known to the State of California to cause cancer, birth defects, and other reproductive harm.

If this product contains a gasoline engine:

WARNING

The engine exhaust from this product contains chemicals known to the State of California to cause cancer, birth defects or other reproductive harm.

The State of California requires the above two warnings.

John Deere Ag Management Solutions

North American Version
PRINTED IN THE U.S.A.



OMPFP10070

Introduction

www.StellarSupport.com

NOTE: Product functionality may not be fully represented in this document due to product changes occurring after the time of printing. Read the latest Operator's Manual and Quick Reference Guide prior to operation. To obtain a copy, see your dealer or visit www.StellarSupport.com

OUO6050,0000FB1 -19-12MAY09-1/1

Contents

	Page
Safety	05- 1
Safety Sign	
Antenna Front View Decal.....	07- 1
Licensing of 450 MHz RTK Base	
Licensing of 450 MHz RTK Base.....	10- 1
RTK Base Station Setup	
System Overview.....	15- 1
Vehicle Receiver.....	15- 2
Base Station Setup.....	15- 3
Base Station Setup—Amplifier Option.....	15- 4
Base Station Setup—Dual Radio.....	15- 6
Radio Power Setting to Meet Licensed ERP....	15-10
GS2 Display iTC—450 MHz RTK	
RTK SoftKey.....	20- 1
Screens Common to Standard and 450 MHz RTK.....	20- 2
RTK Main Page.....	20- 3
RTK Configure Page.....	20- 6
Diagnostic LEDs	
Diagnostic LEDs.....	25- 1
450 MHz RTK Radio LEDs.....	25- 1
Amplifier LEDs.....	25- 2
450 RTK Performance	
450 MHz RTK Accuracy.....	30- 1
Line of Sight.....	30- 2
12.5 kHz versus 25 kHz Bandwidth.....	30- 3
L2 versus L4 GFSK Modulation.....	30- 3
Operation of Vehicle Next to Base.....	30- 3

Original Instructions. All information, illustrations and specifications in this manual are based on the latest information available at the time of publication. The right is reserved to make changes at any time without notice.

COPYRIGHT © 2010
DEERE & COMPANY
Moline, Illinois
All rights reserved.
A John Deere ILLUSTRATION © Manual

Safety

Recognize Safety Information

This is a safety-alert symbol. When you see this symbol on your machine or in this manual, be alert to the potential for personal injury.

Follow recommended precautions and safe operating practices.



T81389 —UN—07DEC88

DX,ALERT -19-29SEP98-1/1

Understand Signal Words

A signal word—DANGER, WARNING, or CAUTION—is used with the safety-alert symbol. DANGER identifies the most serious hazards.

DANGER or WARNING safety signs are located near specific hazards. General precautions are listed on CAUTION safety signs. CAUTION also calls attention to safety messages in this manual.



TS187 —19—30SEP88

DX,SIGNAL -19-03MAR93-1/1

Follow Safety Instructions

Carefully read all safety messages in this manual and on your machine safety signs. Keep safety signs in good condition. Replace missing or damaged safety signs. Be sure new equipment components and repair parts include the current safety signs. Replacement safety signs are available from your John Deere dealer.

There can be additional safety information contained on parts and components sourced from suppliers that is not reproduced in this operator's manual.

Learn how to operate the machine and how to use controls properly. Do not let anyone operate without instruction.

Keep your machine in proper working condition. Unauthorized modifications to the machine may impair the function and/or safety and affect machine life.



TS201 —UN—23AUG88

If you do not understand any part of this manual and need assistance, contact your John Deere dealer.

DX,READ -19-16JUN09-1/1

Prepare for Emergencies

Be prepared if a fire starts.

Keep a first aid kit and fire extinguisher handy.

Keep emergency numbers for doctors, ambulance service, hospital, and fire department near your telephone.

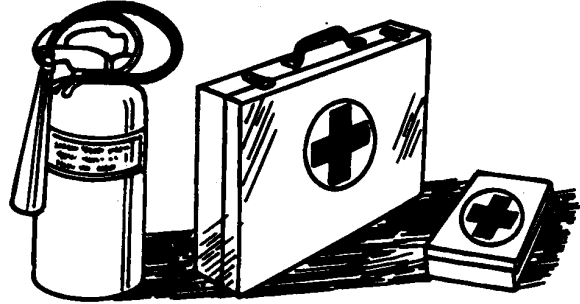

TS291—UN—23AUG88

DX,FIRE2 -19-03MAR93-1/1

Practice Safe Maintenance

Understand service procedure before doing work. Keep area clean and dry.

Never lubricate, service, or adjust machine while it is moving. Keep hands, feet, and clothing from power-driven parts. Disengage all power and operate controls to relieve pressure. Lower equipment to the ground. Stop the engine. Remove the key. Allow machine to cool.

Securely support any machine elements that must be raised for service work.

Keep all parts in good condition and properly installed. Fix damage immediately. Replace worn or broken parts. Remove any buildup of grease, oil, or debris.

On self-propelled equipment, disconnect battery ground cable (-) before making adjustments on electrical systems or welding on machine.

On towed implements, disconnect wiring harnesses from tractor before servicing electrical system components or welding on machine.



TS218—UN—23AUG88

DX,SERV -19-17FEB99-1/1

Handle Global Positioning Receivers and Brackets Safely

Falling while installing or removing a global positioning receiver can cause serious injury. Use a ladder or platform to easily reach a mounting location.

Use sturdy and secure footholds and handholds. Do not install or remove the receiver in wet or icy conditions.

The receiver mast used on implements is heavy and can be awkward to handle. Two people are required when mounting locations are not accessible from the ground or from a service platform. Use proper lifting techniques and wear proper protective equipment.

Do not install or service a RTK base station on a tower or other tall structure unless it provides sturdy and secure

steps and railings. If necessary, use a professional climber.



TSS249 —UN—23AUG88

SH20560,0000116 -19-05DEC09-1/1

Prevent Electrical Shock and Fires

To prevent injury from electrical shock, always disconnect power to the receiver, antenna, and amplifier before installing or servicing.

If installing with the power amplifier option, prevent electrical shock or fire by using a 14 AWG heavy-duty electrical cord with 15 amp rating suitable for outdoor use.

When using an AC/DC converter, always connect to a 120 V outlet protected by Ground Fault Interrupter (GFI).



PUPC000014 —UN—03DEC09

SH20560,0000115 -19-09DEC09-1/1

Avoid Exposure to High Radio Frequency Fields

Prevent injury from exposure to high radio frequency fields at an RTK base station. Do not touch the antenna while the system is transmitting. Always disconnect power to the receiver, radio and amplifier before installing or servicing.

While the RTK base station amplifier and radio are operating together, stay at least 6 ft. (1.8 m) away from the radio antenna for temporary exposure and 12 ft. (3.6 m) away for continual exposure.

While using the RTK base station radio without the amplifier option, stay at least 8 in. (20 cm) away from the radio antenna for temporary exposure and 15 in. (40 cm) away for continual exposure.

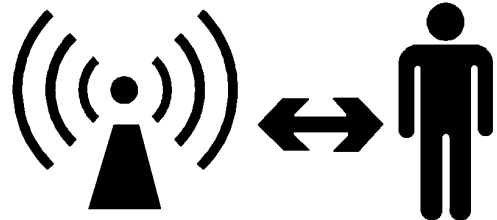

PUPC000015 —UN—03DEC09

SH20560,0000117 -19-05DEC09-1/1

Avoid Electrical Power Lines

Watch for wires. Do not install the base antenna near power lines. It may come into contact with low-hanging electrical cables. This would result in the installer suffering serious injury or death from electrocution.

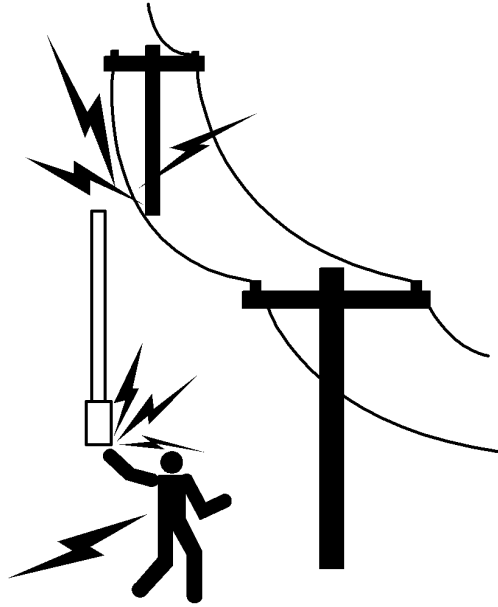

PUPC000036 —UN—09DEC09

SH20560,000012D -19-09DEC09-1/1

Safety Sign

Antenna Front View Decal

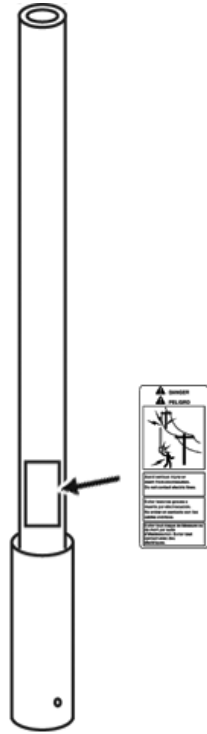

Decal Location

PUPC00037 —UN—10DEC09

⚠ DANGER
⚠ PELIGRO

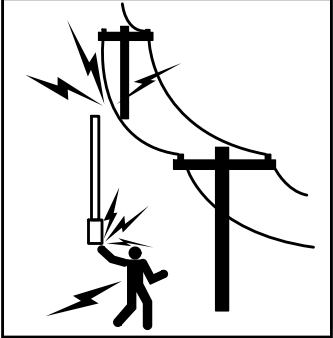

Avoid serious injury or death from electrocution. Do not contact electric lines.

Evitar lesiones graves o muerte por electrocución. No entrar en contacto con los cables eléctricos.

Eviter tout risque de blessure ou de mort par suite d'électrocution. Eviter tout contact avec des électriques.

Antenna Front View Decal

PUPC00034 —UN—09DEC09

SH20560,000012F -19-10DEC09-1/1

Licensing of 450 MHz RTK Base

Licensing of 450 MHz RTK Base

The 900 MHz RTK product sold by John Deere uses ISM band radios. These radios do not require licensing by the end user. The radios are limited to a specific frequency range and 1 W maximum output power. While this system works for the majority of applications, the reliability of the RTK link may become limited when passing through trees and dense foliage.

The intent of 450 MHz RTK is to increase the range and reliability of the RTK link. To overcome the attenuation of adverse field conditions, transmission power greater than 900 MHz RTK is needed. While there is some added benefit from using a radio with lower frequency and longer wavelength, the signal strength is the dominant factor in the radio link reliability. To legally transmit at a higher power, 450 MHz RTK uses a licensed band radio. The end user of the licensed band transmitting radio is responsible for obtaining and maintaining a valid site license from the local spectrum authorities. In 450 MHz RTK system, this requires a license for each base station.

Vehicle radios in 450 MHz system are not transmitters. Since they only receive corrections from the base, 450 MHz vehicle radios do not require a site license.

An end user can apply for the license by applying directly to the local spectrum authority:

Country	Authority
Australia	Australian Communications and Media Authority (ACMA)
Canada	Industry Canada (IC)
United States	Federal Communications Commission
New Zealand	Radio Spectrum Management Group

An end user can also apply with the aid of a frequency coordinator. A frequency coordinator is a private company that has been certified by the local frequency spectrum authority to recommend and aid in the application for a license. For a fee, these third party coordinators will reduce the complexity and confusion of the application process. However, the final responsibility of the license still resides with the end user.

Check www.StellarSupport.com for country specific instructions on how to obtain a site license.

IMPORTANT: Please contact your local radio authorities or partnering frequency coordinator for region specific regulations and licensing.

License Renewal Scams

After being granted a license for 450 MHz RTK radio, base station operators should be aware of license renewal scams. Spectrum licenses are public record. Other companies could retrieve licensee information and then mail current license holders offers to prepare applications for license renewal. The letters contain warnings that there will be monetary penalties if the licensee does not comply. These companies are not affiliated with government spectrum authorities. They are taking advantage of the public record and the licensee's desire to comply with the law. Their intention is to charge a "processing" fee on top of the actual amount that a licensee would pay for renewal. While it is important to not let your license expire, licensees should work directly with their local spectrum authority or a certified frequency coordinator. Internet searches of the companies involved usually identify if the company is relevant.

SH20560,0000118 -19-08DEC09-1/1

RTK Base Station Setup

System Overview

The StarFire™ RTK system consists of a local base station permanently mounted on a structure that transmits high accuracy corrections to the vehicle's StarFire™ receiver using 450 MHz RTK radios and an optional amplifier. The StarFire™ receiver on the RTK equipped vehicle must have a direct line of sight with the base station in order to receive the RTK signal. While the higher transmission power and longer wavelength of 450 MHz RTK aids in the transmission through trees and foliage, it will not penetrate through earth in hilly terrains.

Performance of the RTK correction is related to the operating distance from the base station. When operating

StarFire is a trademark of Deere & Company

beyond 20 km (12 mi.), degraded accuracy will occur and it may take longer to initially acquire the RTK signal.

IMPORTANT: The 900 MHz and 450 MHz RTK radio systems are not compatible. Vehicles with 450 MHz radios must receive corrections from a 450 MHz radio attached to the base. Likewise, vehicles with 900 MHz radios installed must receive their corrections from a base with a 900 MHz radio installed. Different radio models can not communicate with each other since they transmit on different frequencies.

SH20560,0000119 -19-07DEC09-1/1

Vehicle Receiver

Position receiver with integrated RTK radio module is located on top of machine. Position receiver combines the global positioning signals it receives with the RTK differential correction via the radio link to provide accurate position information to the GreenStar™ system.

The receiver has a dedicated operating mode (Vehicle Mode). Refer to *Operating Mode—RTK* in Section *StarFire iTC* for setup of the receiver on vehicle.

IMPORTANT: The antenna must be installed before the radio module is powered ON.

Avoid water intrusion by keeping the antenna attached whenever possible.

Removing the antenna while powered may damage the radio module.

The 450 MHz RTK system is only compatible with the deluxe shroud. This may require a conversion bracket for installation.



PUPC000011—UN—03DEC09

RTK Receiver on Top of Cab



PUPC000003—UN—03DEC09

Wire Bracket on Top of Cab

GreenStar is a trademark of Deere & Company

SH20560,000011A -19-08DEC09-1/1

Base Station Setup

The base station is the most critical part of RTK system. During installation, care must be taken to ensure the base has problem-free operation. There are two issues that are responsible for most problems with a base station: Shading and Multipathing. If a base station experiences one of these problems, it could be detrimental to your RTK operation. These issues are shared with the 900 MHz RTK system. Mitigation techniques have already been documented in the standard StarFire iTC – RTK manual that came with the iTC receiver. This manual provides detailed recommendations to minimizing these errors.

Base station operating mode can be either Absolute Survey Base Mode or Quick Survey Base Mode.

Once you have installed the base station receiver, installing the radio in a location to best maximize the output, can be a challenge. Below are several options currently available through John Deere.

- Leave the RTK radio in its original configuration attached directly behind the base station receiver.
- Use PF80821 extension harness [92 m (300 ft.) in length], moving the radio from the back of the base station receiver to an elevated position, and running the harness in between.

NOTE: It is important to use the PF80821 harness and grounding wire properly according to the installation instructions. This harness has built in protection for both your radio and receiver for unwanted electrical transients developed on the harness.

IMPORTANT: The antenna must be installed before the radio module is powered ON.

Avoid water intrusion by keeping the antenna attached whenever possible. Removing the antenna while transmitting may damage the radio module.

IMPORTANT: If using coaxial cable between the radio and the antenna, you need to use the lowest-loss cable available or you may suffer RTK radio link range issues.

- Attach the RTK radio in a secured location and run low-loss coaxial cable between the radio and the antenna.

NOTE: When using this option, it may be necessary to install a higher-gain antenna and/or the optional amplifier to compensate for loss.

450 MHz RTK Radio Specifications

Model Number	PF81428
Frequency Range	435-470 MHz
Bandwidth Options	25 or 12.5 kHz
Modulation	2 and 4 level GFSK
RF Baud, 25 kHz BW	19.2 kbps at L2
RF Baud, 12.5 kHz BW	9.6 kbps at L2
Frequency Channels	1400 at 25 kHz 2800 at 12.5 kHz
Output Power	0.2-2 W
Sensitivity	-110 dBm for 10 ⁻⁶ BER
In/Out Impedance	50 ohm
Operating Voltage	9-15 V
Operating Temperature	-30 to 60° C
Out RF Connectors	Female TNC
Control Connector	4-pin Deutsch

Every 450 MHz radio comes standard with 2 dBi whip antenna that has a TNC connection.

450 MHz Whip Antenna Specifications

Model Number	PF81464
Gain	2 dBi
Frequency Range	450-470 MHz
Impedance	50 ohm
VSWR	< 2:1
RF Connector	Female N-Type
Length	13.2 in. (33.5 cm)

Always mount the radio antenna vertically to make sure that the RTK signal is radiating outwards. If the antenna is at an angle, it may cause the data received at the vehicle to be lower than expected.

NOTE: The 450 MHz RTK whip antenna, PF81464, looks similar to 900 MHz and 869 MHz RTK whip antennas. To differentiate, it has a white stripe near its tip.

Base Station Setup—Amplifier Option

⚠ CAUTION: Install and operate the amplifier safely. Read and follow **PREVENT ELECTRICAL SHOCK AND FIRES** and **AVOID EXPOSURE TO HIGH RADIO FREQUENCY FIELDS** in the **SAFETY** section.

The primary reason for 450 MHz RTK is to provide a more robust RTK data link. Signal strength is the dominant factor in the link reliability and range. For areas where there are trees and other foliage, John Deere offers an optional in-line amplifier.

The PF81443 amplifier is a UHF RF power amplifier intended for use in 450 MHz RTK system. It is not intended to be used with 900 MHz RTK or any other applications. The amplifier can deliver RF power from 0 to 50 W proportional to the 0 to 2 W input from 450 MHz RTK Radio. It covers a frequency range from 450 MHz to 470 MHz. This higher signal strength provides greater range from the base and increased coverage in areas with dense foliage and trees.

This amplifier is inserted between the radio and the base antenna. The amplifier has been designed to function outdoors attached to its mounting plate with sun shade. Mount the amplifier in an area where air can freely circulate around it. If possible, mount in a location shaded from direct sunlight.

Operation of the amplifier inside an enclosure is not recommended. Poor ventilation within the box can cause the amplifier to overheat. While this would not permanently damage the amplifier, it would cause it to

stop amplification. The output signal would no longer be strong enough for the vehicles in the field to receive.

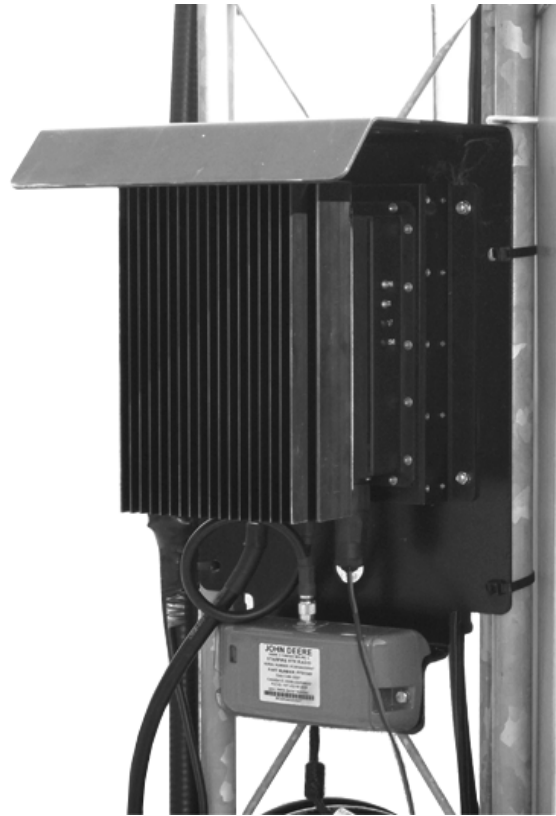

Amplifier Assembly

PUPC000027—UN—06DEC09

Continued on next page

SH20560,000011C -19-08DEC09-1/2

450 MHz Amplifier Specifications

Model Number	PF81443
Frequency Range	450-470 MHz
Input Power	0-2 W
Output Power	0-50 W
Current During Transmission	8 amp
Nominal Voltage	13.8 V DC
Internal fuse	15 amp
In/Out Impedance	50 ohm
Operating Voltage	11-15 V
Max Duty Cycle	100%
Operating Temperature	-30 to 60° C
In RF Connector	Female TNC
Out RF Connectors	Female N-Type
Power Connector	Amphenol (EcoMate C016 20D003 110 12)

There are 3 connections located at the bottom of the power amplifier:

1. 12 VDC power input
2. RF input via TNC connector
3. RF output via N-Type connector

The connectors should only be finger-tight. Using tools can over tighten and damage the RF and power connectors.

A 13.8 V power supply capable of providing a constant 10 amp to the amplifier is required. Amplifier operation with insufficient voltage can lead to higher amplifier operating temperatures. Insufficient current can cause the amplifier to not amplify or only partially amplify the RF signal. These conditions result in incomplete or no RTK transmissions being received by the vehicle.

IMPORTANT: Make sure the antenna and coax are attached before the amplifier module is powered ON or damage to the amplifier could



Amplifier Connection Ports

occur. Do not remove the coax or antenna while the amplifier is powered ON. Avoid water intrusion by keeping the connections attached whenever possible.

Make sure the power connector is attached and unpowered when handling the RF IN and RF OUT connectors. The ground provided by the power connector protects the amplifier against possible electrostatic discharge.

PUPC00028 —UN—06DEC09

SH20560,000011C -19-08DEC09-2/2

Base Station Setup—Dual Radio

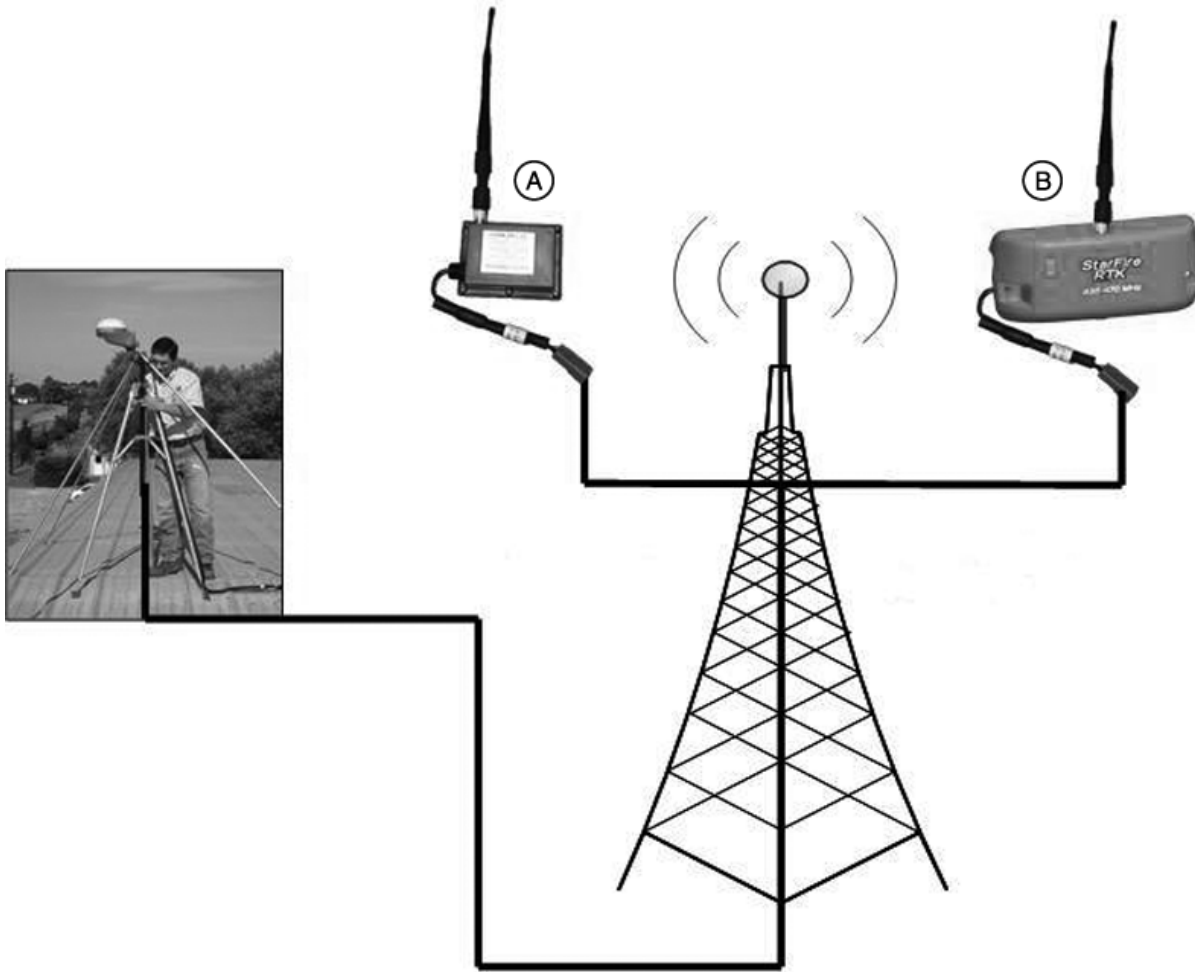

Dual Base Radio Cartoon

A—900 MHz

B—450 MHz with Amplifier

A single base station receiver can be used to support both the 900 MHz RTK and the 450 MHz RTK concurrently.

An additional harness is required that splits the RS232 correction stream from the StarFire™ receiver into two.

StarFire is a trademark of Deere & Company

PUPC000005—UN—03DEC09

Continued on next page

SH20560,000011D -19-08DEC09-1/4

RTK Base Station Setup

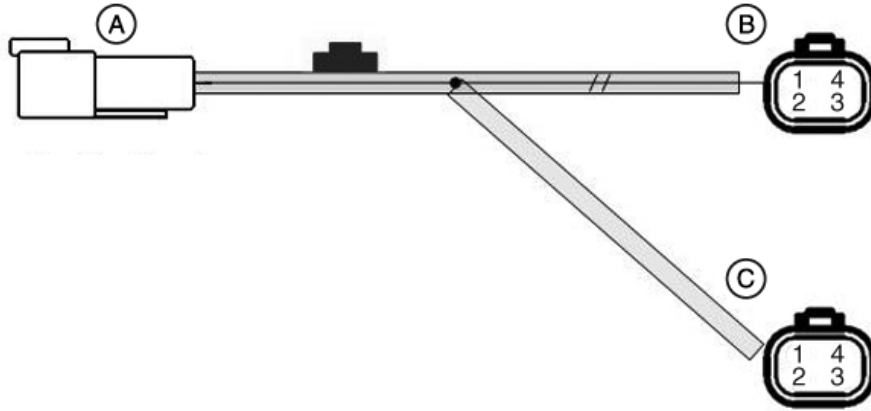

PUPC000030—UN—07DEC09

Dual Base RTK Harness Schematic

A—StarFire™ Receiver

B—400 MHz Radio Receiver and Configure

C—900 MHz Radio Receiver Only

A - StarFire™ Receiver	
Terminal	Detail
1	12 V Power
2	Tx (From SF)
3	Rx (To SF)
4	Gnd

C - 900 MHz Radio Receiver Only	
Terminal	Detail
1	12 V Power
2	Tx (From SF)
3	None
4	Gnd

B - 400 MHz Radio Receiver and Configure	
Terminal	Detail
1	12 V Power
2	Tx (From SF)
3	Rx (To SF)
4	Gnd

Continued on next page

SH20560,000011D -19-08DEC09-2/4

The ability to use a single base station is a substantial reduction in cost and maintenance. The drawback to this method is that only one radio can be configured at a time. A single RS232 port is used by the StarFire™ receiver to communicate with an RTK radio. Two radios can simultaneously receive RTK corrections from the receiver. Unfortunately, the receiver can not process simultaneous messages sent from the radios. The two radios send different messages and interfere. To ensure that this interference does not occur, the dual radio harness has the radio send wire in only one branch.

To prevent network connection errors, a specific procedure must be followed when configuring a base station supporting two radios:

1. Connect the Dual Radio Harness to the StarFire™ Receiver.
2. Power the base station StarFire™ Receiver with only 900 MHz connected to 4-wire Deutsch connector. The receiver must have clear view of the sky.
3. Once the receiver determines its position, configure 900 MHz radio Network ID and Radio Channel.
4. Power down the base station StarFire™ Receiver.
5. Disconnect 900 MHz radio and then connect 450 MHz radio to the 4-wire Deutsch connector.
6. Once the receiver determines its position and recognizes the radio, configure 450 MHz radio to comply with the site license.
7. Power down the receiver.
8. With 450 MHz radio still attached to the 4-Wire Deutsch connector, connect the 900 MHz radio to the 3-wire Deutsch connector.
9. Power the base station.

IMPORTANT: Do not attempt to change the radio parameters while both radios are attached. This can corrupt the configuration of 900 MHz radio and may cause problems with rovers liking to it. If this does occur, reconfigure the radios with the process given above.

During normal operation, ensure that 450 MHz radio is connected to the 4-wire connector and that 900 MHz radio is connected to the 3-wire connector. If the receiver detects a 900 MHz radio, 450 MHz radio link may be compromised. At its lowest data speed, the 450 MHz radio does not have the capacity to transmit corrections at the 900 MHz radio rate.



4-Wire RTK Connector



3-Wire RTK connector

PUPC00007—UN—03DEC09

PUPC00008—UN—03DEC09

Vehicles using 900 MHz will see fewer messages received when using a dual radio base station as their correction source. The mandatory narrow bandwidth of the licensed band radio results in a slower over-the-air baud rate. 450 MHz RTK uses the same message rates for most configurations. However, the message rate had to be reduced for the default narrowband settings to 2 messages per second.

Bandwidth (kHz)	GFSK Modulation	Data Rate (bps)	RTK Corrections/second
25	L4	38,400	5
25	L2	19,200	5
12.5	L4	19,200	5
12.5	L2	9,600	2

Continued on next page

SH20560,000011D -19-08DEC09-3/4

The 900 MHz RTK message rates are designed with extra redundancy. System performance is not compromised at 2 Hz message rate. Both 900 MHz and 450 MHz RTK systems have sufficient redundancy to ensure RTK reliability and accuracy. The diagnostic reading on vehicles with 900 MHz radios will be based on 5 Hz message rate. The result is that 900 MHz customers receiving corrections from base with a narrowband L2 attached will be 40% data received at best.

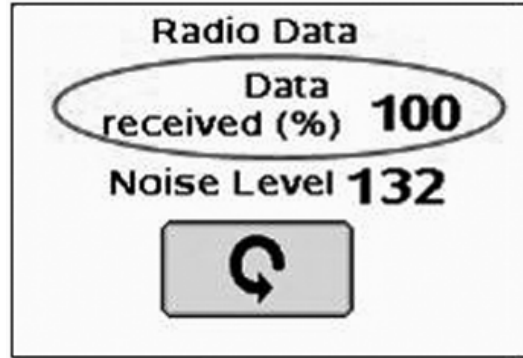

Data Received 5 Hz

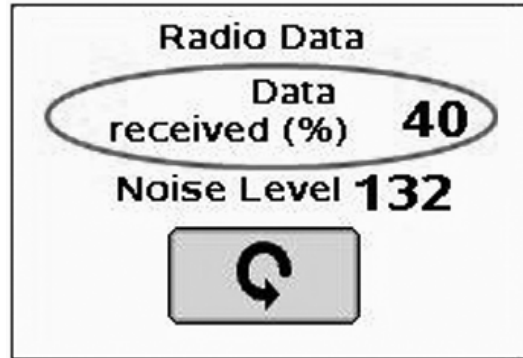

Data Received 2 Hz

PUPC000009 —UN—03DEC09

PUPC000010 —UN—03DEC09

SH20560,000011D -19-08DEC09-4/4

RTK Base Station Setup

Radio Power Setting to Meet Licensed ERP

The 450 MHz RTK system has been designed to meet a wide range of possible configurations. This gives the end user the ability to optimize the system for their specific location and application. The end user must obtain a site license from the local spectrum authorities. It is the end user's responsibility to ensure that 450 MHz RTK system parameters are configured correctly. Frequency, bandwidth, output power and antenna height must all conform to the granted license.

The frequency, bandwidth and output power of the John Deere 450 MHz radio are programmable by the StarFire™ receiver. The available ranges are:

Frequency	435 – 470 MHz
Frequency Resolution	12.5 kHz
Bandwidth	12.5 or 25 kHz
Radio Output Power	0.2 to 2.0 W
Amplifier Output Power	5.0 to 50.0 W

When installing a base station, the total output power of the system must be adjusted to comply with the granted license. Cable losses, connection losses and the antenna gain must be considered when calculating the total system output power. The radio output power is configured using GreenStar 2 System™ Display. Equivalent Radiated Power (ERP) of the radio should be adjusted to ensure that the total 450 MHz RTK system output power complies with the license granted by the local spectrum authority. The following tables can be used to determine the appropriate setting.

Radio Only Power Output												
LRS-455 Output Power Watts	No Coax			15 in. (4.6 m)			100 in. (30.5 m)			200 in. (61 m)		
	2 dBi Whip	5 dBi Magnetic Mount	7 dBi Base	2 dBi Whip	5 dBi Magnetic Mount	7 dBi Base	2 dBi Whip	5 dBi Magnetic Mount	7 dBi Base	2 dBi Whip	5 dBi Magnetic Mount	7 dBi Base
2.0	3.2	6.3	—	2.8	5.6	8.9	2.0	3.9	6.2	1.2	2.5	3.9
1.6	2.5	5.0	—	2.2	4.5	7.1	1.6	3.1	4.9	1.0	2.0	3.1
1.3	2.0	4.0	—	1.8	3.6	5.6	1.2	2.5	3.9	0.8	1.6	2.5
1.0	1.6	3.2	—	1.4	2.8	4.5	1.0	2.0	3.1	0.6	1.2	2.0
0.8	1.3	2.5	—	1.1	2.2	3.6	0.8	1.6	2.5	0.5	1.0	1.6
0.6	1.0	2.0	—	0.9	1.8	2.8	0.6	1.2	2.0	0.4	0.8	1.2
0.5	0.8	1.6	—	0.7	1.4	2.2	0.5	1.0	1.6	0.3	0.6	1.0
0.4	0.6	1.3	—	0.6	1.1	1.8	0.4	0.8	1.2	0.2	0.5	0.8
0.3	0.5	1.0	—	0.4	0.9	1.4	0.3	0.6	1.0	0.2	0.4	0.6
0.3	0.4	0.8	—	0.4	0.7	1.1	0.2	0.5	0.8	0.2	0.3	0.5
0.2	0.3	0.6	—	0.3	0.6	0.9	0.2	0.4	0.6	0.1	0.2	0.4

Radio and Amplifier Power Output												
LRS-455 Output Power Watts	No Coax			15 in. (4.6 m)			100 in. (30.5 m)			200 in. (61 m)		
	2 dBi Whip	5 dBi Mag Mnt	7 dBi Base	2 dBi Whip	5 dBi Mag Mnt	7 dBi Base	2 dBi Whip	5 dBi Mag Mnt	7 dBi Base	2 dBi Whip	5 dBi Mag Mnt	7 dBi Base
2.0	79.2	158.1	—	70.6	140.9	223.3	48.9	97.5	154.5	30.8	61.5	97.5
1.6	62.9	125.6	—	56.1	111.9	177.4	38.8	77.4	122.7	24.5	48.9	77.4
1.3	50.0	99.8	—	44.6	88.9	140.9	30.8	61.5	97.5	19.5	38.8	61.5
1.0	39.7	79.2	—	35.4	70.6	111.9	24.5	48.9	77.4	15.5	30.8	48.9
0.8	31.5	62.9	—	28.1	56.1	88.9	19.5	38.8	61.5	12.3	24.5	38.8
0.6	25.1	50.0	—	22.3	44.6	70.6	15.5	30.8	48.9	9.7	19.5	30.8
0.5	19.9	39.7	—	17.7	35.4	56.1	12.3	24.5	38.8	7.7	15.5	24.5
0.4	15.8	31.5	—	14.1	28.1	44.6	9.7	19.5	30.8	6.2	12.3	19.5
0.3	12.6	25.1	—	11.2	22.3	35.4	7.7	15.5	24.5	4.9	9.7	15.5
0.3	10.0	19.9	—	8.9	17.7	28.1	6.2	12.3	19.5	3.9	7.7	12.3
0.2	7.9	15.8	—	7.0	14.1	22.3	4.9	9.7	15.4	3.1	6.1	9.7

GreenStar 2 System is a trademark of Deere & Company

SH20560,000011E -19-09DEC09-1/1

GS2 Display iTC—450 MHz RTK

RTK SoftKey

450 MHz RTK is supported by VI displays. These include GreenStar 2 System™ Displays and SDUA. Configuration with the original GreenStar™ Display is not supported.

Allows for setup and display of both Standard RTK and 450 MHz RTK information:

- Operating Mode
- RTK Network Configuration
- Base Station Data
- Radio Data

The 450 MHz RTK shares the same activation as 900 MHz RTK. The iTC receiver automatically detects which radio is connected at start-up and adjusts its screens for the appropriate radio when the softkey is pressed.

450 MHz RTK can be operated in three modes:

- Vehicle
- Quick Survey Base
- Absolute Base

IMPORTANT: Any time the radio is reconfigured or changed, power must be cycled at the GPS receiver before continuing.

Vehicle Mode Select this mode if the receiver is on a vehicle.

Quick Survey Base Mode Select if exact location of guidance tracks do not need to be stored for future applications. If Quick Survey Base Mode is used to establish rows or paths that will be used at a later date, location or Track 0 must be stored using Current Track 0 in Guidance Setup – Set Track 0. When Track 0 is recalled, a onetime use of Shift Track feature will be needed to align vehicle on previous tracks.

Absolute Survey Base Mode Select if exact location of guidance tracks need to be stored for future guidance applications without relying on visual reference for track position to align using Shift Track feature. Track 0 must

*GreenStar 2 System is a trademark of Deere & Company
GreenStar is a trademark of Deere & Company*

PC8663 —UN—05AUG05



MENU Button

PC8659 —UN—05AUG05



StarFire iTC Button

PC8689 —UN—09AUG05

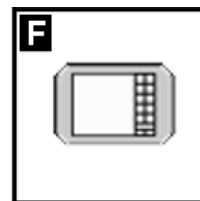

RTK Softkey

be stored using Current Track 0 in Guidance Setup – Set Track 0 in order to follow previously used tracks. Absolute Base Mode requires 24 hour self survey to be conducted on location before first use. After survey is completed, base station will then transmit corrections. If base station is moved to another position and then returned to original surveyed position, it is very important that base station is mounted in exact same position. Any difference between original surveyed position and mounted position will result in offset of corrected position. For this reason, it is important to mount receiver to a fixed position like a building or post mounted in concrete.

OFF Mode This mode disables all RTK functionality in receiver. RTK Operating Mode must be OFF for normal SF1 or SF2 operation on SF2 licensed receiver.

SH20560,0000120 -19-04DEC09-1/1

Screens Common to Standard and 450 MHz RTK

When RTK is in the OFF mode, the main pages are common between the two systems. The details of these particular pages are provided in the *StarFire iTC and RTK Operator's Manual*. This manual was provided with the purchase on an iTC receiver. When in VEHICLE or BASE mode, the pages for 450 MHz RTK system vary slightly from the pages for 900 MHz RTK system.

There is single RTK activation that provides access to both 900 MHz RTK and 450 MHz RTK. The difference between the two systems is the radio hardware. After power is supplied, the receiver links up to the attached radio and shows the relevant screens.

The Rover Access List currently used for 900 MHz RTK is unchanged. When upgrading to 450 MHz RTK, previous

lists remained stored in the receiver. The methods of adding, editing and deleting Rover receiver serial numbers remains unchanged.

Several other features in 900 MHz RTK are also provided unchanged in the 450 MHz RTK:

- RTK-x
- Optimized shading
- Radio self test page
- Absolute Base Coordinate Setup
- TCM Calibration

Repeaters are not supported in 450 MHz system. Because a vehicle repeater would be a mobile transmitter, it requires a different type of license.

SH20560,0000121 -19-04DEC09-1/1

RTK Main Page

IMPORTANT: Base station receiver and vehicle receiver must be setup before operating RTK. See *RTK Base Station Setup* Section.

NOTE: Check that base station and vehicle have same Frequency, Bandwidth, Baud Rate and Network ID.

RTK Main—Vehicle

A—The *Radio ID* control has been replaced with the *Radio Frequency (MHz)*

B—Only *Radio* is referenced on the *Configure* button title.

C—The *Radio Connection* control is disabled since repeaters are not supported with the 450 MHz RTK.

RTK Main—Vehicle

The majority of the diagnostics and controls are the same as 900 MHz RTK on the RTK Main – vehicle screen. Three items have been modified on the RTK Main Page for 450 MHz RTK.

Press: MENU Button >> StarFire iTC™ Button >> RTK Softkey >> OPERATING MODE drop-down box >> VEHICLE

StarFire iTC is a trademark of Deere & Company

Continued on next page

SH20560,0000122 -19-05DEC09-1/3

PUPC000016—UN—08DEC09

RTK Main—Base Station

StarFire iTC - RTK

SN 339215

Operating Mode

Quick Survey Base ▲▼

RTK Network Configuration	Base Station Data
Radio Frequency 462.61250 (MHz)	Status OK
Network ID 1 1 - 4000	Sat. Corrections 6
Radio Configure	Distance (ft) 5.19
	Direction (°) 163
	Base Battery (V) 12.3
	Location #
	Quick Survey

Radio Data

Noise Level

132

↻

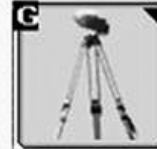

PUPC000018—UN—04DEC09

RTK Main Vehicle (Quick Survey Base)

StarFire iTC - RTK
SN 339215

Operating Mode

Absolute Base

RTK Network Configuration

Radio Frequency 462.61250 (MHz)

Network ID 1

1 - 4000

Radio Configure

Base Station Data

Status **Stored Base**

Sat. Corrections **none**

Distance (ft) **0.00**

Direction (°) **0**

Base Battery (V) **12.3**

Location #

No Stored Base

Radio Data

Noise Level

126

↻

Edit stored RTK Base

Start

Caution

RTK Main Vehicle (Absolute Base)

The Quick Survey Base and Absolute Base versions of the RTK Main screens also display the frequency of the radio link.

PUPC000017 - UN - 04DEC09

RTK Configure Page

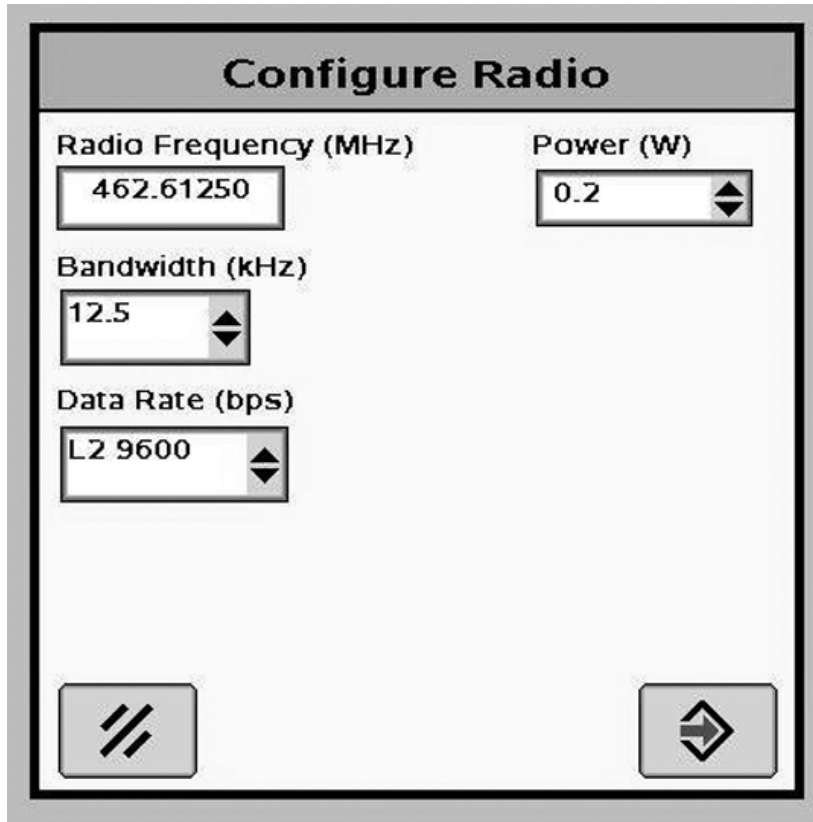

Configure Radio Screen

PUPC000026—UN—05DEC09

The frequency and power settings for 900 MHz RTK are fixed to comply with ISM band requirements. For 450 MHz RTK, these settings can be controlled and are the responsibility of the end user. Besides the Network ID on the RTK Main screen, there are four parameters that manage the radio link between the vehicle and Base: Radio Frequency, Bandwidth, Data Rate and Power.

The **Radio Frequency** is the center frequency of the link shared between the Base and Rover.

The **Bandwidth** is the range of the frequency that the transmitted signal is modulated. This range, or band, is centered about the Radio frequency. For example, if the radio is set at 460 MHz with a bandwidth of 12.5 kHz, then the radio link will be contained within 460 ± 0.0125 MHz.

The **Data Rate** is the over-the-air speed of the data link. This baud rate is directly related to the bandwidth setting

of the radio. The signal to noise increases with larger bandwidth. A larger bandwidth is therefore related to higher baud rates. Two Data Rate settings are provided for each bandwidth. L2 is the lower speed and provides the maximum radio link range. L4 has twice the speed, but comes at the cost of reduced range.

Press: MENU Button >> StarFire iTC™ Button >> RTK Softkey >> Radio Configure Button

The output power control is only displayed when the receiver is set to Quick Survey Base or Absolute base Operating Modes. When the receiver is set as a Vehicle, the radio output power is set to its lowest output power since it is a receiver only.

The cancel button disregards any input to the Radio Configure screen and returns the user to the RTK Main page.

StarFire iTC is a trademark of Deere & Company

Continued on next page

SH20560,0000123 -19-05DEC09-1/3

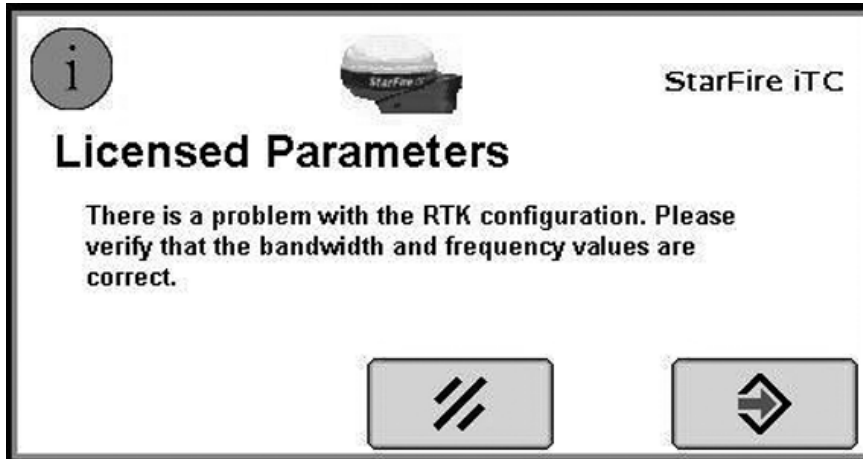

Invalid Parameters Pop-up

When the return button is pressed, verification is made on the input radio parameters. If the combination inputs are invalid, a pop-up screen will appear to communicate this.

SH20560,0000123 -19-05DEC09-2/3

PUPC000019 —UN—04DEC09

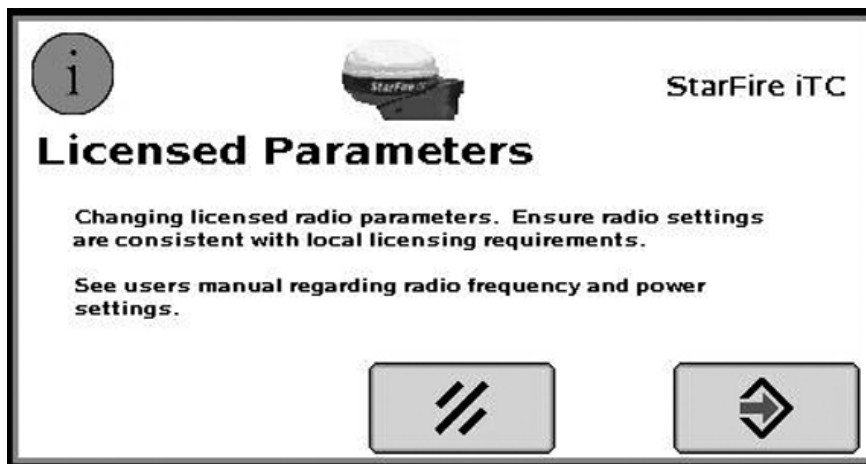

Valid Parameters Pop-up

When a valid set of parameters is entered, a confirmation screen will pop-up reminding the user not to vary from the parameters designated in the license.

The 450 MHz RTK system is capable of operating over a wide range of frequency and power settings. Since the final license parameters granted to the customer is unknown to the manufacturer, this system flexibility exists

to enable use by a large range of customers and markets. The end user has the responsibility of configuring the system parameters to meet the license granted them by the local spectrum authority. Frequency, bandwidth and output power (if a base) will be designated by the local license, and the base must be set to comply with these specifications.

SH20560,0000123 -19-05DEC09-3/3

PUPC000020 —UN—04DEC09

Diagnostic LEDs

Diagnostic LEDs

A key aid to gain insight into the working state of the 450 RTK system are the LEDs on both the RTK radio and

the in-line amplifier. These diagnostic lights can be used during setup, maintenance and troubleshooting.

SH20560,0000124 -19-04DEC09-1/1

450 MHz RTK Radio LEDs

There are three radio LEDs. They can be seen after the radio has been powered. They are viewed through a small window on the front of the radio.

The LEDs can be used to determine

- Is the radio powered?
- Is the radio is configured as a Base Station or a vehicle?
- Is the radio searching or linked?
- Is the radio in configuration mode?

The radio enters configuration mode when parameters are being read/set or when diagnostics are being retrieved. While in configure mode, the radio does not transmit or receive communications.

The meanings of the radio LED states are provided in the table below.



LED Window

PUPC000021—UN—06DEC09

SH20560,0000125 -19-07DEC09-1/2

450 RTK	Base Station (TX)	Vehicle (RX)
Searching	Master does not search. See Linked and Master Transmitting	<input type="checkbox"/> Solid Red <input type="checkbox"/> Off <input type="checkbox"/> Slow Blinking Red
Linked and Master Transmitting	<input type="checkbox"/> Solid Red <input type="checkbox"/> Fast Blinking Red <input type="checkbox"/> Off	<input type="checkbox"/> Solid Green <input type="checkbox"/> Off <input type="checkbox"/> Solid Red
Configuring	<input type="checkbox"/> Solid Green <input type="checkbox"/> Solid Green <input type="checkbox"/> Solid Green	<input type="checkbox"/> Solid Green <input type="checkbox"/> Solid Green <input type="checkbox"/> Solid Green

Radio LEDs Table

PUPC000032—UN—07DEC09

SH20560,0000125 -19-07DEC09-2/2

Amplifier LEDs

There are four amplifier LEDs. They are located on the side of the amplifier.

The LEDs can be used to determine

- Is the amplifier powered?
- Is there an internal failure?
- Is the radio signal being amplified?
- Is the amplifier setup causing it to overheat?
- Is the antenna or its connection path faulty?

The LEDs operate in two states: *Start Up* and *Operation*.

After the amplifier is initially powered, the amplifier strobes through each LED sequentially. This rapid flashing sequence indicates that the internal firmware test sequence is initiated. It checks the power to the unit and the integrity of internal components.

The outcome of a successful startup test sequence results in only the PWR LED on. The outcome of an unsuccessful startup sequence results in the PWR LED and any of the red LEDs on. These red LEDs indicate a failure.

During normal operation after a successful startup, each amplifier LED has a specific meaning.

Power LED Indicates that the amplifier has DC power.

TX LED Indicates that an RF signal is being actively amplified and transmitted. This light blinking indicates normal function.

O/T LED Indicates that the unit has exceeded its internal temperature limits. When this light is on, the unit will cease amplification. This allows the unit to cool and prevents permanent damage.

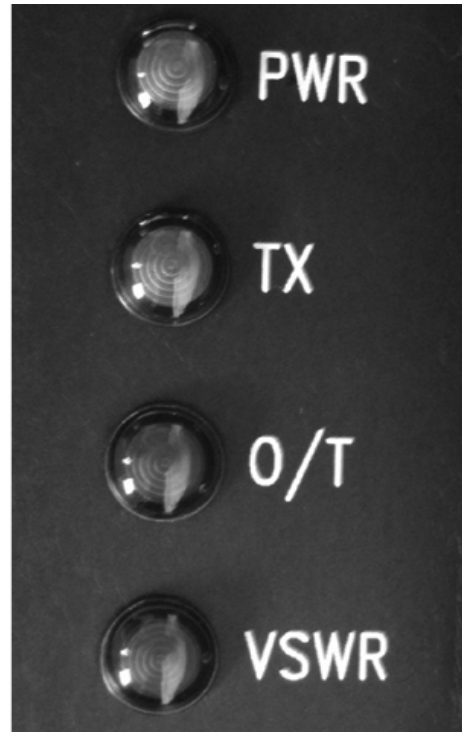

Amplifier LED

VSWR LED Indicates that the antenna path is faulty. When this light is on, the unit will cease amplification. This prevents the output power from being reflected back into the amplifier and causing permanent damage.

PUPC000031 —UN—07DEC09

SH20560,0000126 -19-08DEC09-1/1

450 RTK Performance

450 MHz RTK Accuracy

The accuracy of 450 MHz RTK is the same as 900 MHz RTK. The UHF link is more robust, but the content sent by the StarFire RTK™ base to the vehicle is identical.

StarFire RTK™ delivers 1 in. repeatable accuracy. RTK accuracy is expressed as an absolute value (without +/-)

StarFire RTK is a trademark of Deere & Company

because RTK performance is not subject to GPS drift over time. RTK accuracy levels are described on a static basis measured at the vehicle receiver, 68 percent of the time, within 12 mi. (20 km) line of sight with the base station, assuming unobstructed view of the sky, favorable PDOP, and correct base station setup.

SH20560,0000127 -19-04DEC09-1/1

Line of Sight

Line of sight is the direct path between two points, free of obstacles. For the RTK application, this is the line between the base and vehicle antennas. Typical obstructions include:

- Trees and foliage
- Buildings or other man-made objects
- Terrain variation, such as hills or valleys
- Curvature of the Earth

The higher RF power of 450 MHz RTK will reduce attenuation due to plants and small variations in terrain.

Blockage due to man-made objects can be reduced through planning of the base antenna location. Similar to analysis performed to locate the StarFire™ receiver installation, the transmitting antenna should be located away from nearby obstructions.

To deal with obstructions away from the base, small terrain variations and the curvature of the Earth, the antenna should be placed as high as possible. The local spectrum authority will limit the range and potential interference of the base station signal by setting a maximum power and maximum antenna height. End users should install their base antenna to the maximum height allowed for best performance.

StarFire RTK™ retains its published accuracy to 12 mi. (20 km). If consistent with the granted site license, it is recommended that antennas are mounted ≥ 30 m (100 ft.) to ensure the full range of coverage. The table below relates the base antenna height to the line-of-sight to the base radio horizon.

Base Height	Base Station Radio Horizon	Base Height	Base Station Radio Horizon	Line of Sight
<i>ft.</i>	<i>mi.</i>	<i>m</i>	<i>km</i>	
148	16.3	45	26.3	Strong
131	15.4	40	24.8	
125	15.0	38	24.2	
115	14.4	35	23.2	
98	13.4	30	21.5	Good
82	12.2	25	19.6	
66	10.9	20	17.6	Marginal
49	9.4	15	15.2	
33	7.7	10	12.4	Poor
20	6.0	6	9.6	
10	4.2	3	6.8	
5	3.0	1.5	4.8	

Antenna Height

RTK Shared Base Station: Antenna Height

StarFire is a trademark of Deere & Company
 StarFire RTK is a trademark of Deere & Company

PC9393 —UN—23OCT06



In order to maintain a good RTK Radio link, the antenna must be mounted high enough to radiate over the earth's curvature and any obstacles. As shown in the figure, the curve of the earth can block the signal from the RTK link. If the radiating base station radio antenna is mounted too low, the broadcasting range will be drastically reduced.

Continued on next page

SH20560,0000128 -19-09DEC09-1/2

12.5 kHz versus 25 kHz Bandwidth

There are two possible bandwidths that can be set in the 450 MHz RTK radio:

25 kHz	Wideband
12.5 kHz	Narrowband

The 25 kHz bandwidth delivers twice the baud rate of the 12.5 kHz. Wide bands have more data capacity and faster message transmission than narrow bands. In the RTK system, this results in a more robust data link. However, the disadvantage to using a larger bandwidth is that fewer licensed frequencies are available to applicants. To more

efficiently use the available frequencies, some spectrum authorities are transitioning from older wideband licensing plans to narrowband licensing plans.

For example, in the United States the FCC has established January 1, 2013 as the deadline for migration to 12.5 kHz technology. Applications for wideband operations (25 kHz channels) will be accepted until January 1, 2011. All existing Part 90 radio systems operating on frequencies between 150-512 MHz have eight years to convert those systems either to 12.5 kHz bandwidth or to a technology that provides one voice path per 12.5 kHz of bandwidth or provides a data rate of 4800 bps per 6.25 kHz.

SH20560,000012A -19-08DEC09-1/1

L2 versus L4 GFSK Modulation

The 450 MHz RTK radio is a digital transmitter. There are two possible modulation techniques that can be set in 450 MHz RTK radio: Level 2 (L2) or Level 4 (L4) Gaussian Frequency-Shift Keying (GFSK).

When transmitting with L2 modulation, 1's and 0's are sent by shifting the frequency between two possible states about the center frequency within the bandwidth of the radio. The "Gaussian" term refers to a technique of smoothing the transition between the two frequencies.

When transmitting with L4 modulation, the radio shifts between four frequencies about the center frequency. This allows four different symbols to be sent during a

single transmission: 00,01,10,and 11. This results in 2x the over-the-air speed as the L2 modulation technique. The drawback is that the signal to noise is lower with the L4 technique relative to the L2. This is because the vehicle radio must differentiate between 4 frequencies instead of only 2.

The default modulation for the 450 MHz RTK is L2. This provides the greatest RTK range. L4 will be an advantage in selected applications. One example is operation near the base where small objects frequently block the line of sight. Here the signal strength is sufficient for L4. The higher baud rate results in short transmission times. These messages then have a lower probability of being blocked.

SH20560,000012B -19-08DEC09-1/1

Operation of Vehicle Next to Base

Depending on the base station setup, operation of vehicles directly under or next to the base may be limited. The 450 MHz system has both higher power and higher signal sensitivity than standard RTK. A consequence of this is that radio signals in the immediate vicinity of the

transmitter may be too strong for the receiving radios. For base stations that serve vehicles at both ≥ 20 km and ≤ 1 km from the base, it may be necessary to add inline RF attenuators to the rovers operating directly under the base. Attenuator specifications: RF load of 15 dBm, capable of 2W, inline female TNC to male TNC.

SH20560,000012C -19-04DEC09-1/1

Index

	Page		Page
A			
Absolute Base Page, RTK Main	20- 3	Main Page-Quick Survey Base	20- 3
Accuracy	30- 1	Main Page-Vehicle	20- 3
Antenna Front View Decal	07- 1	Softkey	20- 1
B			
Bandwidth	30- 3	System Overview	15- 1
Base Station Setup	15- 3	Vehicle Receiver	15- 2
Amplifier Option	15- 4	RTK Accuracy	30- 1
Dual Radio	15- 6	RTK Configure Page	20- 6
Base Station Setup - Amplifier Option	15- 4	RTK Main Page	20- 3
Base Station Setup—Dual Radio	15- 6	RTK Softkey	20- 1
Base Station, RTK Main	20- 3	RTK Vehicle Page	20- 3
C			
Common Screens	20- 2	S	
Configure Page, RTK	20- 6	Safety Sign	07- 1
D			
Decal	07- 1	Screens Common to Standard and 450 MHz RTK... ..	20- 2
Diagnostic	25- 1	Setting to Meet Licensed ERB.....	15-10
Diagnostic LEDs	25- 1	Sight	30- 2
Difference between Bandwidth	30- 3	Softkey.....	20- 1
Difference between Modulation	30- 3	Standard and 450 MHz RTK Common Screens.....	20- 2
L			
L2 versus L4 GFSK Modulation.....	30- 3	System Overview.....	15- 1
Line of Sight.....	30- 2	V	
M			
Modulation	30- 3	Vehicle Next to Base	30- 3
O			
Operation of Vehicle Next to Base.....	30- 3	Vehicle Page, RTK Main.....	20- 3
Q			
Quick Survey Base Page, RTK Main.....	20- 3	Vehicle Receiver.....	15- 2
R			
Radio Power Setting	15-10		
Radio Power Setting to Meet Licensed ERB	15-10		
RTK			
450 MHz and Standard Common Screens	20- 2		
Base Station Setup	15- 3		
Base Station Setup - Amplifier Option	15- 4		
Base Station Setup—Dual Radio.....	15- 6		
Main Page.....	20- 3		
Main Page-Absolute Base	20- 3		
Main Page-Base Station	20- 3		

John Deere Service Literature Available

Technical Information

Technical information can be purchased from John Deere. Some of this information is available in electronic media, such as CD-ROM disks, and in printed form. There are many ways to order. Contact your John Deere dealer. Call **1-800-522-7448** to order using a credit card. Search online from <http://www.JohnDeere.com>. Please have available the model number, serial number, and name of the product.

Available information includes:

- **PARTS CATALOGS** list service parts available for your machine with exploded view illustrations to help you identify the correct parts. It is also useful in assembling and disassembling.
- **OPERATOR'S MANUALS** providing safety, operating, maintenance, and service information. These manuals and safety signs on your machine may also be available in other languages.
- **OPERATOR'S VIDEO TAPES** showing highlights of safety, operating, maintenance, and service information. These tapes may be available in multiple languages and formats.
- **TECHNICAL MANUALS** outlining service information for your machine. Included are specifications, illustrated assembly and disassembly procedures, hydraulic oil flow diagrams, and wiring diagrams. Some products have separate manuals for repair and diagnostic information. Some components, such as engines, are available in separate component technical manuals
- **FUNDAMENTAL MANUALS** detailing basic information regardless of manufacturer:
 - Agricultural Primer series covers technology in farming and ranching, featuring subjects like computers, the Internet, and precision farming.
 - Farm Business Management series examines "real-world" problems and offers practical solutions in the areas of marketing, financing, equipment selection, and compliance.
 - Fundamentals of Services manuals show you how to repair and maintain off-road equipment.
 - Fundamentals of Machine Operation manuals explain machine capacities and adjustments, how to improve machine performance, and how to eliminate unnecessary field operations.



TS189 —UN—17JAN89



TS191 —UN—02DEC88

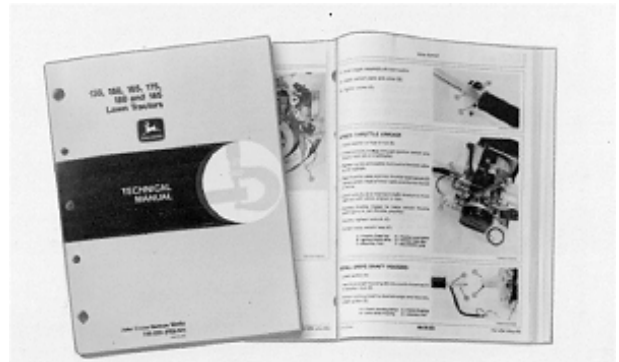

TS224 —UN—17JAN89



TS1663 —UN—10OCT97

DX,SERVLIT -19-31,JUL03-1/1

John Deere Service Keeps You On The Job

John Deere Is At Your Service

CUSTOMER SATISFACTION is important to John Deere.

Our dealers strive to provide you with prompt, efficient parts and service:

- Maintenance and service parts to support your equipment.
- Trained service technicians and the necessary diagnostic and repair tools to service your equipment.



CUSTOMER SATISFACTION PROBLEM RESOLUTION PROCESS

Your John Deere dealer is dedicated to supporting your equipment and resolving any problem you may experience.

1. When contacting your dealer, be prepared with the following information:

- Machine model and product identification number
- Date of purchase

-Nature of problem

2. Discuss problem with dealer service manager.
3. If unable to resolve, explain problem to dealership manager and request assistance.
4. If you have a persistent problem your dealership is unable to resolve, ask your dealer to contact John Deere for assistance. Or contact the Ag Customer Assistance Center at 1-866-99DEERE (866-993-3373) or e-mail us at www.deere.com/en_US/ag/contactus/.

DX,IBC,2 -19-01MAR06-1/1

TS201 -UN-23AUG88

