

T184367
DeereTrax®
VCA10023

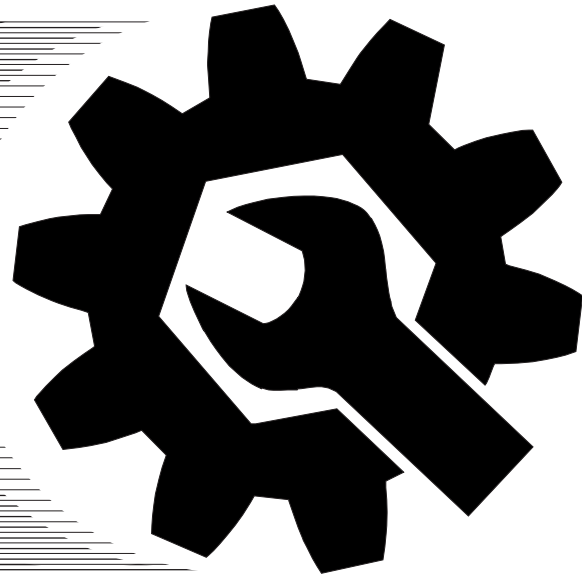

**INSTALLATION
INSTRUCTIONS**



All
1600
C, F, U

John Deere Dubuque Works
DeereTrax (03FEB00)
ENGLISH

COPYRIGHT © 2000
DEERE & COMPANY
Moline, Illinois
All rights reserved
A John Deere ILLUSTRATION® Manual
DeereTrax-19-03FEB00

LIVE WITH SAFETY

Before returning machine to customer, make sure machine is functioning properly, especially the safety systems. Install all guards and shields.



TS231 -19-07OCT88

DX,LIVE -19-25SEP92-1/1

PARTS LIST

Part numbers may change without notice.

Replacement parts are available through your John Deere dealer.

• Installation Kit VCA10023

- VCA10000 Communications Controller Harness
- VCA10001 Communications Controller
- VCA10002 Power Harness
- VCA10003 LED Light Harness
- VCA10029 Cellular Antenna Whip and Ferrule
- VCU10028 Cellular Antenna Cable
- VCA10005 Antenna Mounting Bracket and Clamp
- VCU10008 GPS (Global Positioning System) Antenna And Cable
- VCU10009 Alcohol Wipe
- VCU10010 Hook and Hook Fastener (Type 400)
- VCU10011 Hook and Hook Fastener (Type 250)
- VCU10012 Primer 97 (For Hook and Hook Fastener) (3 used)
- VCU0013 Self Tapping Screw 6mm x 75mm (4 Used)
- VCU10014 Installation Instructions T184367
- VCU10017 U-bolt (2 used)
- VCU10019 Wire 16 ga. 12 ft.
- VCU10020 Convoluted Tubing 12 ft.
- VCU10022 6mm Lock Washer (4 used)
- VCU10031 Flat Washer Stainless Steel .250 in. (2 used)
- VCU10035 Cellular Antenna And Cable
- VCU10034 Cellular Antenna Cable
- AT180705 Ground Strap
- H159144 Grommets (3 used)
- R105388 Tie Band (25 used)
- T178552 Connectors (6 used)
- Heat Shrink Tubing T178552 (6 used)
- Template (Hole Location For Controller)
- 14M7194 Nut Hex 6mm (2 used)
- 14M7229 Nut Hex 5mm (3 used)
- 14M7151 Nut Hex 8mm (2 used)
- 19H1648 Cap Screw 3/8-16 x 3/4
- 24M7138 Washer 5mm (3 used)
- 24M3739 Washer 8mm (2 used)
- 24M7105 Washer 6mm (2 used)

Installation Instruction

- 24H1136 Washer 5/16 x .734 x .065
- 24H1622 Washer 3/8 x .870 x .083
- 37H37 Self Tapping Screw 5/16 x 0.75

CED,TX13067,2386 -19-02FEB99-2/2

PARTS INCLUDED IN KIT

T128007B

T128007B -UN-

1—VCA10002 Power
Harness

POWER HARNESS

Continued on next page

CED,TX13067,2662 -19-31JAN00-1/12

T128008B

T128008B -UN-

1—VCA10000
Communications
Controller Harness

2—VCA10003 LED Light
Harness

**COMMUNICATIONS CONTROLLER AND LED
HARNESSES**

Continued on next page

CED,TX13067,2662 -19-31JAN00-2/12

COMMUNICATIONS CONTROLLER

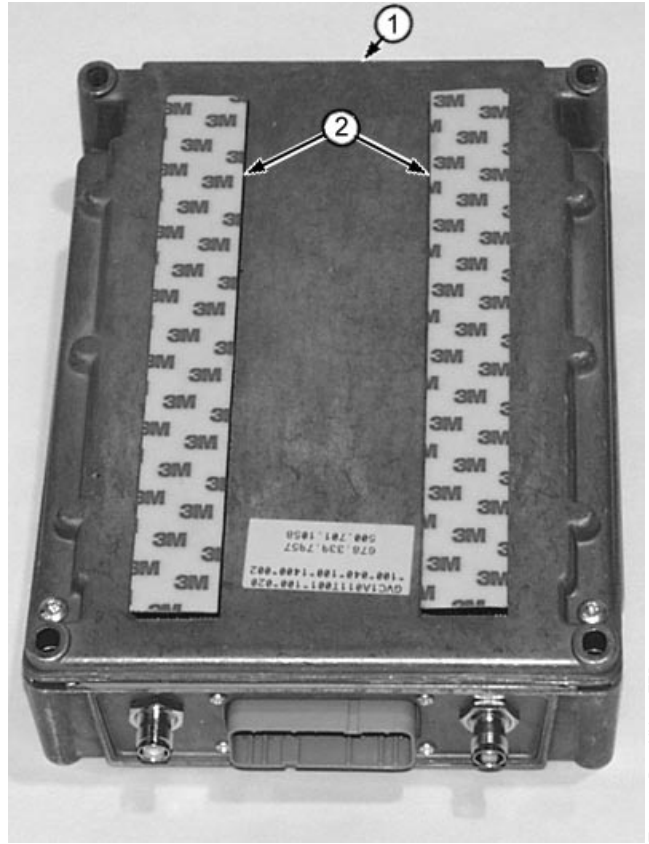

T127991B -UN-02FEB00

- 1—VCA10001 Communications Controller
- 2—VCU10010 and VCU10011 Hook and Loop Fastener

Continued on next page

CED,TX13067,2662 -19-31JAN00-3/12

COMMUNICATIONS COMMUNICATOR MOUNTING HARDWARE

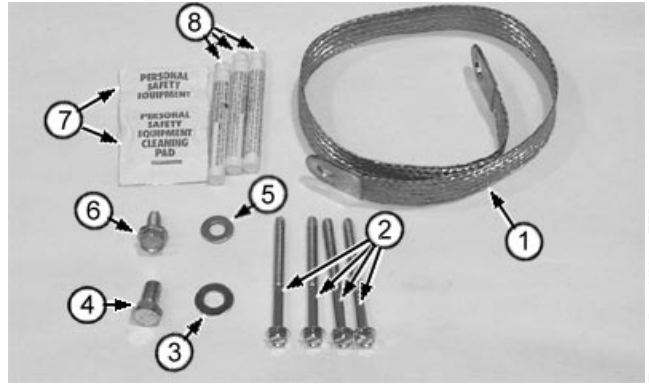

T127992B -UN-02FEB00

- 1—AT180705 Ground Strap
- 2—VCU10013 6mm x 75mm Self Tapping Screws (4)
- 3—24H1622 Washer 3/8 x .870 .083
- 4—19H1648 Cap Screw 3/8-16 x 3/4
- 5—24H1136 Washer 5/16 x .734 x .065
- 6—37H37 5/16 x .75 Self Tapping Screw
- 7—VCU10009 Alcohol Wipe (2)
- 8—VCU10012 Primer 97 (3)

CED,TX13067,2662 -19-31JAN00-4/12

ALTERNATOR HARDWARE

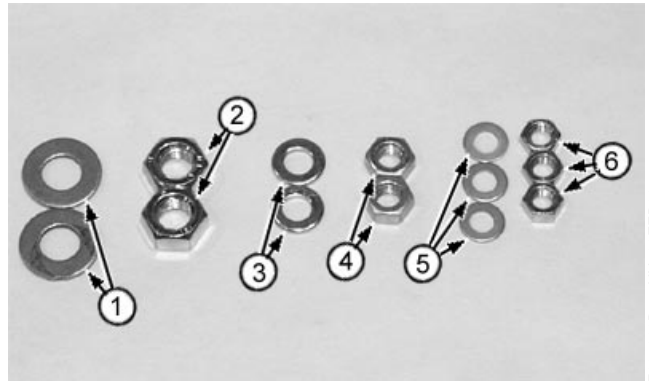

T127993B -UN-02FEB00

- 1—24M3739 8mm Flat Washer (2)
- 2—14M7151 8mm Hex Nut (2)
- 3—24M7105 6mm Flat Washer (2)
- 4—14M7194 6mm Hex Nut (2)
- 5—24M7138 5mm Flat Washer (3)
- 6—14M7229 5mm Hex Nut (3)

Continued on next page

CED,TX13067,2662 -19-31JAN00-5/12

INSTALLATION AND OPERATING INSTRUCTIONS

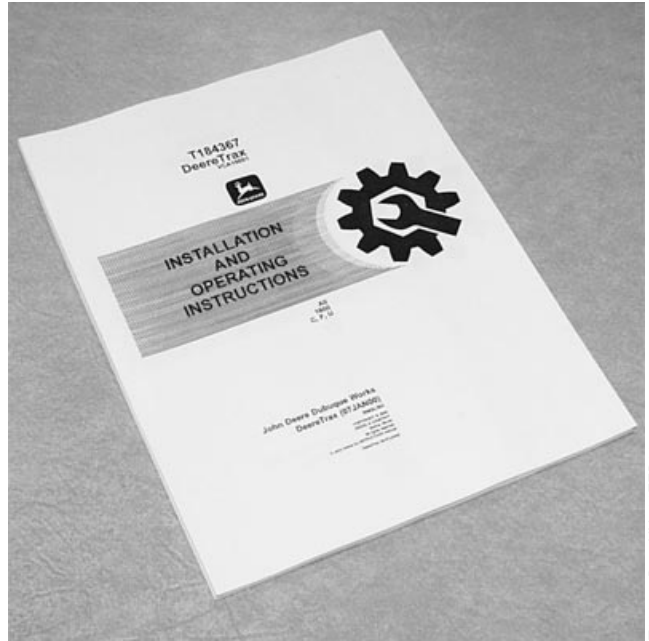

T128067B -UN-03FEB00

Installation and Operating Instructions

Continued on next page

CED,TX13067,2662 -19-31JAN00-6/12

HARNESS ROUTING HARDWARE



T127996B -UN-02FEB00

- 1—VCU10020 Convoluted Tubing and VCU10019 Wire
- 2—T178552 Connectors (6)
- 3—T178552 Heat Shrink Tubing (6)
- 4—AT159144 Grommet (3)
- 5—R105388 Tie Band (25)

Continued on next page

CED, TX13067, 2662 -19-31JAN00-7/12

ANTENNA MOUNT BRACKET



T128082B -UN-03FEB00

1—VCU10005 Antenna Mounting Bracket

Continued on next page

CED,TX13067,2662 -19-31JAN00-8/12

ANTENNA MOUNTING U-BOLTS

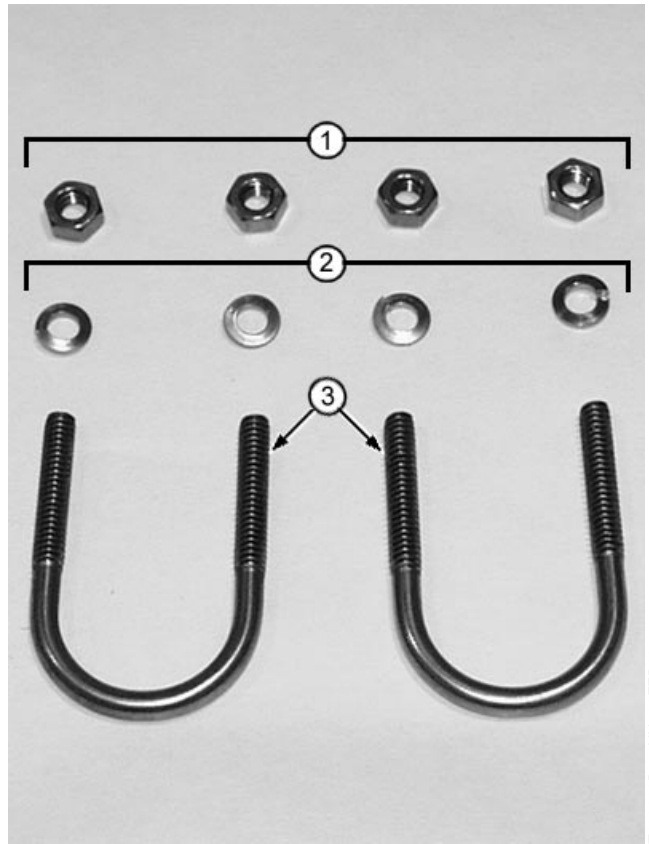

- 1—14H387 1/4-20 Hex Nut (4)
- 2—VCU10022 6mm Lock Washer (4)
- 3—VCU10017 U-Bolts (2)

T128002B -UN-02FEB00

CED,TX13067,2662 -19-31JAN00-9/12

CELLULAR ANTENNA

VCU10035 Cellular antenna includes all parts shown.



- 1—Antenna
- 2—Rubber Washer

T127999B -UN-02FEB00

Continued on next page

CED,TX13067,2662 -19-31JAN00-10/12

CELLULAR ANTENNA CABLE

VCU10034 Cellular antenna cable includes all parts shown.



T128068B -UN-03FEB00

- 1—Cable
- 2—Nut
- 3—O-Ring

CED,TX13067,2662 -19-31JAN00-11/12

GPS ANTENNA AND CABLE

VCU10008 GPS antenna includes all parts shown.

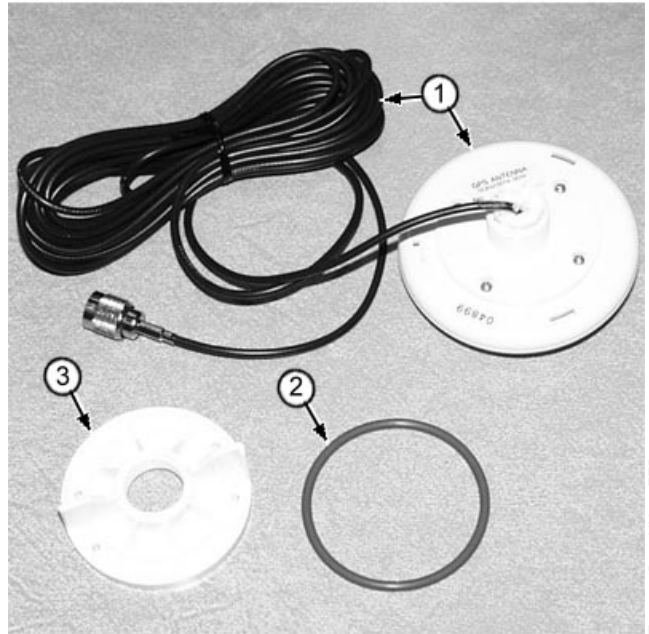

T128001B -UN-02FEB00

- 1—Antenna and cable
- 2—O-Ring
- 3—Nut

CED,TX13067,2662 -19-31JAN00-12/12

TOOLS AND EQUIPMENT

Not Supplied With Kit

- Drill Bits
 - #4 or 7/32 in.
 - 17/64 in.
 - 3/8 in.
 - 1/2 in.
 - 3/4 in.
 - Uni-Bit®
- Volt-Ohmmeter
- Electric Drill
- Duct Tape
- Electrical Tape
- Screw Drivers
- Metric and SAE Wrenches
- Fish Tape
- Utility Knife
- Wire Crimping Tool
- Weatherpack Tool JDG364

CED, TX13067,2455 -19-03AUG99-1/1

CUSTOMER SUPPORT CENTER

The Customer Support Center will assist dealers or customers having problems installing or operating.

Customer Support Center phone number:
1-800-939-0805.

CED, TX13067,2452 -19-03AUG99-1/1

CUSTOMER PERSONAL SERVICE (CPS)

Note to customer:

CPS will be used to gain access to your vehicle's information via the Internet through the Deere Web Site at <http://cps.deere.com>

CED,TX13067,2453 -19-03AUG99-1/1

CELLULAR PHONE SERVICE

DeereTrax communicates via a built-in cellular phone. The unit is pre-programmed at the factory and will be activated when it is shipped to the dealer. If problems arise, contact the Customer Support Center at 1-800-939-0805.

CED,TX13067,2454 -19-03AUG99-1/1

BASIC SYSTEM LAYOUT

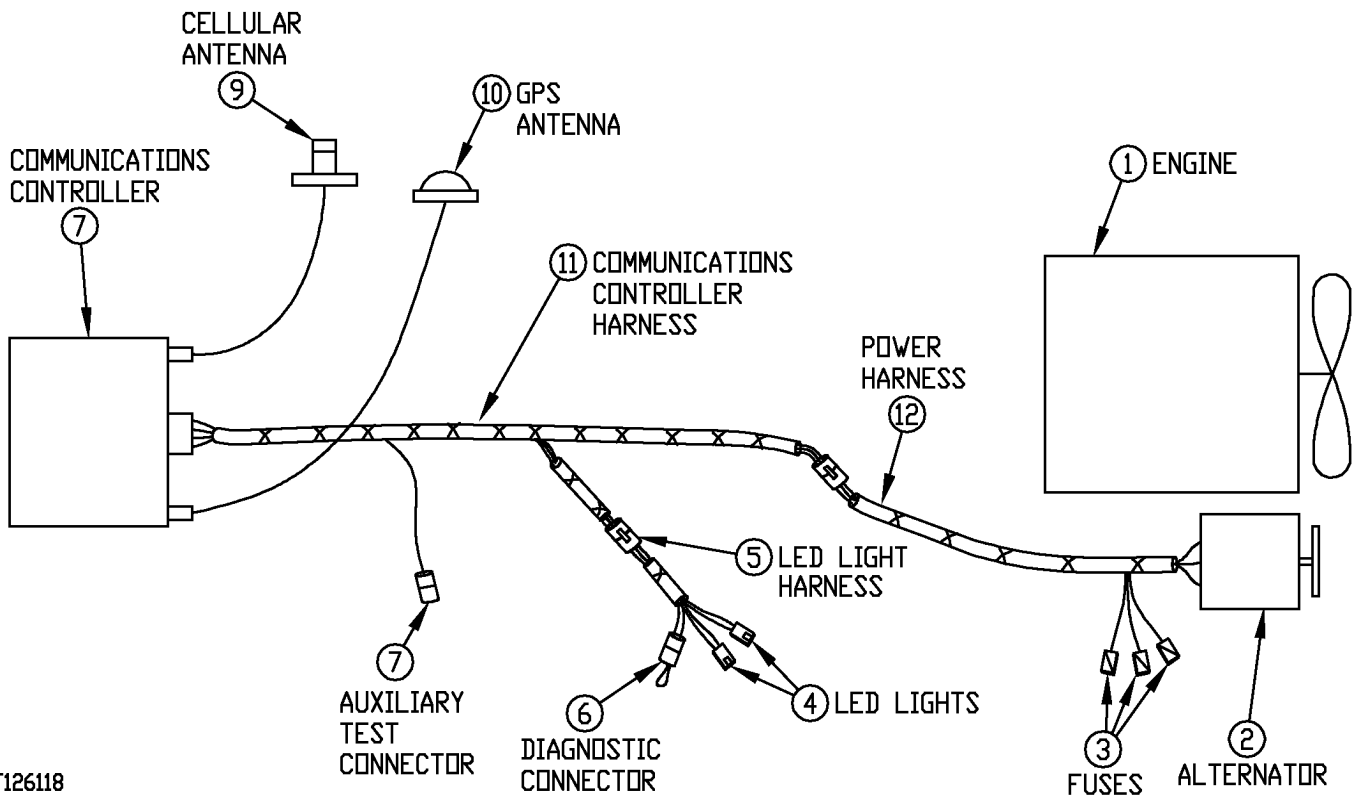

T126118

- 1—Engine
- 2—Alternator
- 3—Fuses
- 4—LED Lights

- 5—Diagnostic Connector
- 6—Auxiliary Connectors
- 7—Communications Controller

- 8—Cellular Antenna
- 9—GPS Antenna
- 10—Communications Harness

- 11—Power Harness

Basic components of the system are:

1. Antennas and antenna cables
2. Harnesses
3. Communications controller

Before installation is started, read this instruction.

Find the best location for each component.

Follow guidelines to prevent components from becoming damaged during machine operation.

Make sure components are close enough to communications controller so cables will reach.

CED, TX13067, 2596 -19-19NOV99-1/1

T126118 -19-02FEB00

SELECTING MOUNTING LOCATION FOR COMMUNICATIONS CONTROLLER

IMPORTANT: Before doing any work on an electrical component, turn battery disconnect switch OFF or disconnect negative battery cable. Damage to electrical components may result if terminals are shorted during maintenance.

Never install close to the engine, transmission or hydraulic tank where temperature may exceed 70°C (160°F). Never install on a panel that vibrates excessively. Controller damage may result if exposed to excessive heat or vibration.

- Install communications controller in a protected area where it won't be exposed to excessive heat or damage from chains or tools carried in the cab. The load center area of a 4-wheel drive loader is an ideal location.
- Avoid installation in areas where temperature can exceed 70°C (160°F). Typical areas to avoid are inside the engine compartment, next to a hydraulic tank or transmission.
- Select a location so harness connectors and antenna cables can be attached or removed easily.
- Do not install in a location that will prevent removal of other components.
- Install controller horizontally or with connectors down to prevent water or oil from collecting in harness connections.
- Before final location is chosen, check power harness length and antenna cable length.

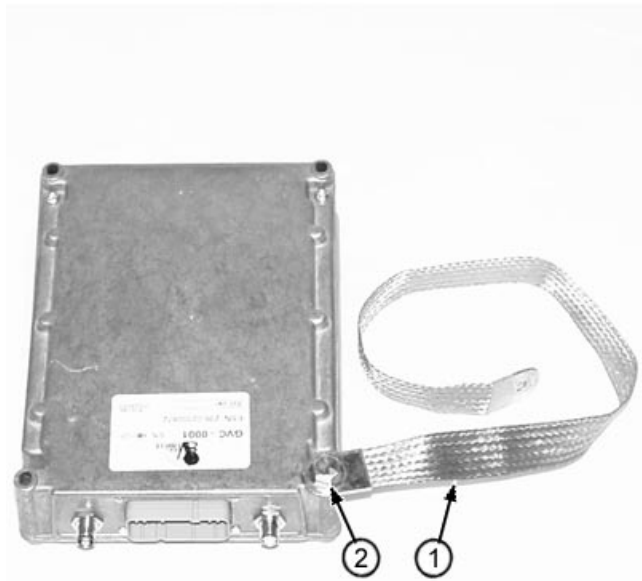

T127567B -UN-22JAN00

CED, TX13067, 2458 -19-03AUG99-1/1

INSTALLING COMMUNICATIONS CONTROLLER

Communications controller can be installed using hook and hook fastener or using cap screws. Choose the best procedure for your application.

CED,TX13067,2600 -19-22NOV99-1/4

INSTALLING COMMUNICATIONS CONTROLLER USING HOOK AND HOOK FASTENER

1. Communications controller already has hook and hook fastener attached.
2. Clean installation area of machine using VCU10009 alcohol wipe (3) then apply VCU10012 Primer 97 (2), to the cleaned area. Follow directions on primer tube.
3. Remove clear strips (1) from hook and hook fastener and press communications controller firmly into place.

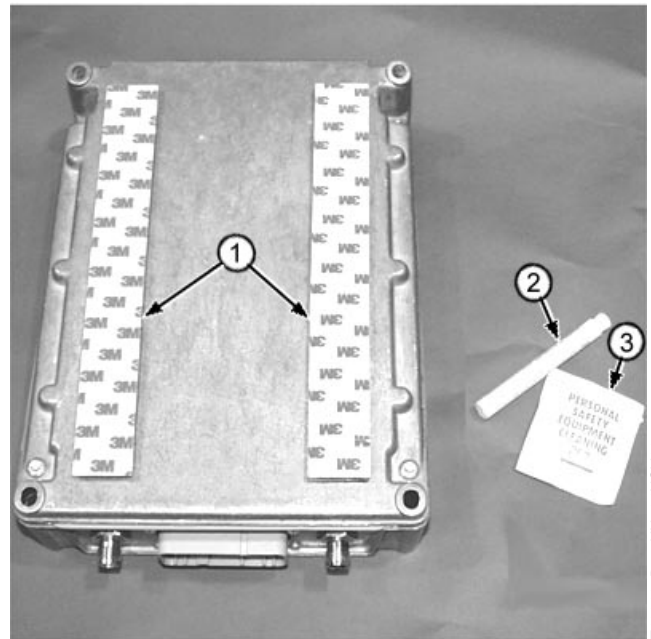

T126195B -UN-24NOV99

- 1—Hook and Hook Clear Strips
- 2—VCU10012 Primer 97
- 3—VCU10009 Alcohol Wipe

Continued on next page

CED,TX13067,2600 -19-22NOV99-2/4

4. One hole in the communications controller has internal threads. Install Capscrew (2) to attach Ground Strap (1).
5. Attach other end of ground strap (1) to a good clean ground connection on the machine.



T127567B -UN-22JAN00

1—AT180705 Ground Strap
2—19H1648 Cap Screw

CED, TX13067,2600 -19-22NOV99-3/4

INSTALLING COMMUNICATIONS CONTROLLER USING CAP SCREWS

1. Choose a mounting area using guidelines in Selecting Mounting Location For Communications Controller.
2. Use template to locate mount holes. (See Drill Template For Communications Controller on next page)
3. Drill mount holes using a No. 4 or 7/32 bit.
4. Install Self-tapping cap screws (1). Use one screw to attach ground strap (2).
5. Attach other end of ground strap to a good clean ground connection on the machine.

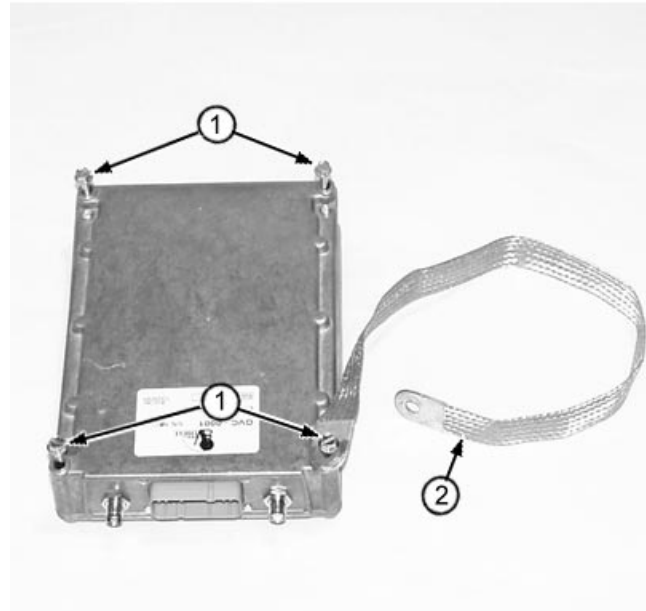

T127570B -UN-01FEB00

1—VCU10013 6mm x 75 Self Tapping Cap Screw
(4 used)
2—AT180705 Ground Strap

CED, TX13067,2600 -19-22NOV99-4/4

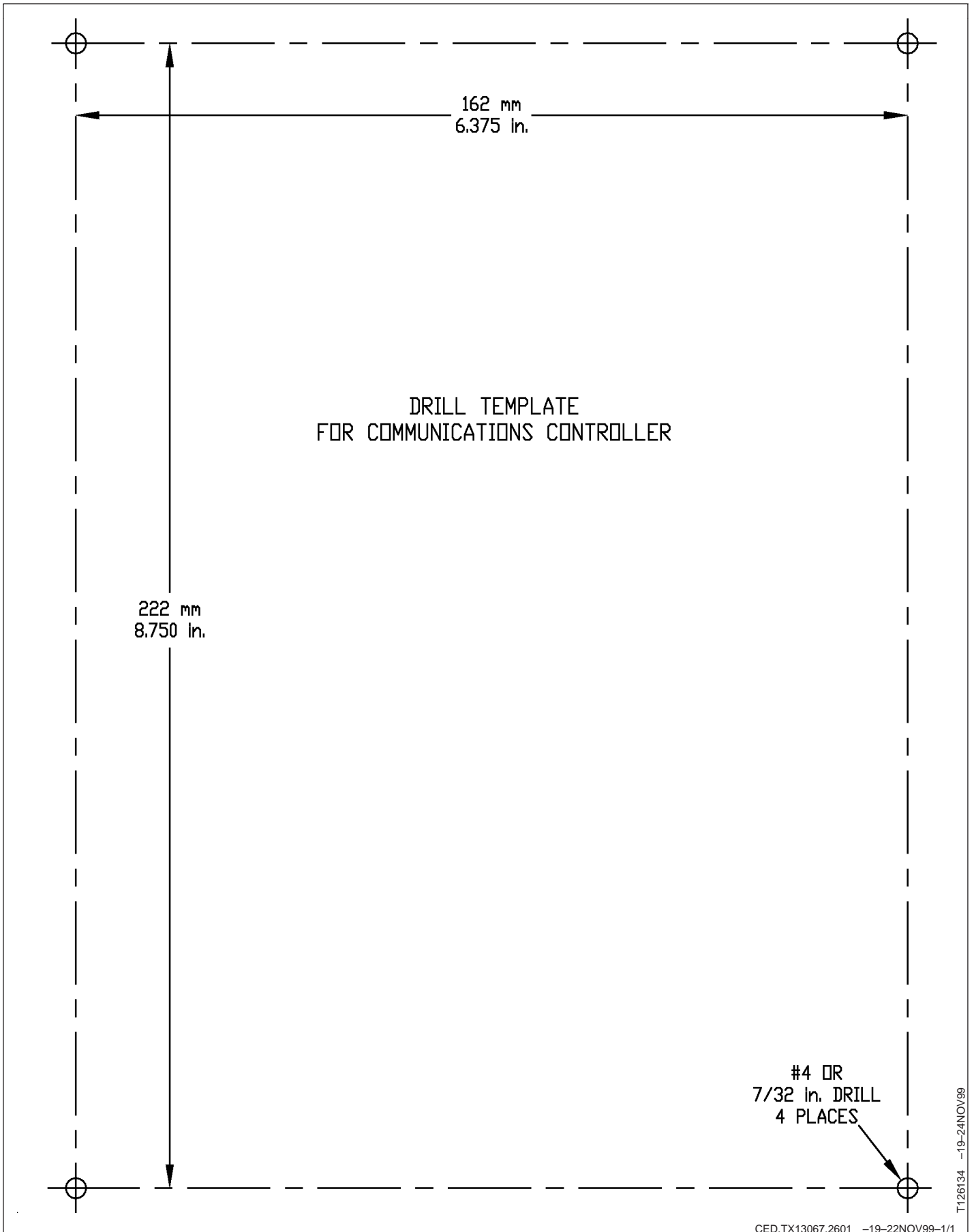

T126134 -19-24NOV99

CED, TX13067, 2601 -19-22NOV99-1/1

REMOVING COMMUNICATIONS CONTROLLER

1. To remove the communications controller after installing with the hook and hook fastener:
 - a. Carefully pry controller from mounting surface starting at a corner. To prevent hook and hook fastener from pulling away from controller, push your finger between the fastener pieces.
 - b. If hook and hook fastener pulls loose from the controller, press it back in place.
2. To reinstall the controller, align hook and hook fastener strips on controller and mounting surface, then press controller against one end of the fastener strips and “rock” into full contact.

Slowly apply pressure along full length of controller until fasteners are secure.

CED, TX13067, 2664 -19-02FEB00-1/1

INSTALLING COMMUNICATIONS CONTROLLER HARNESS

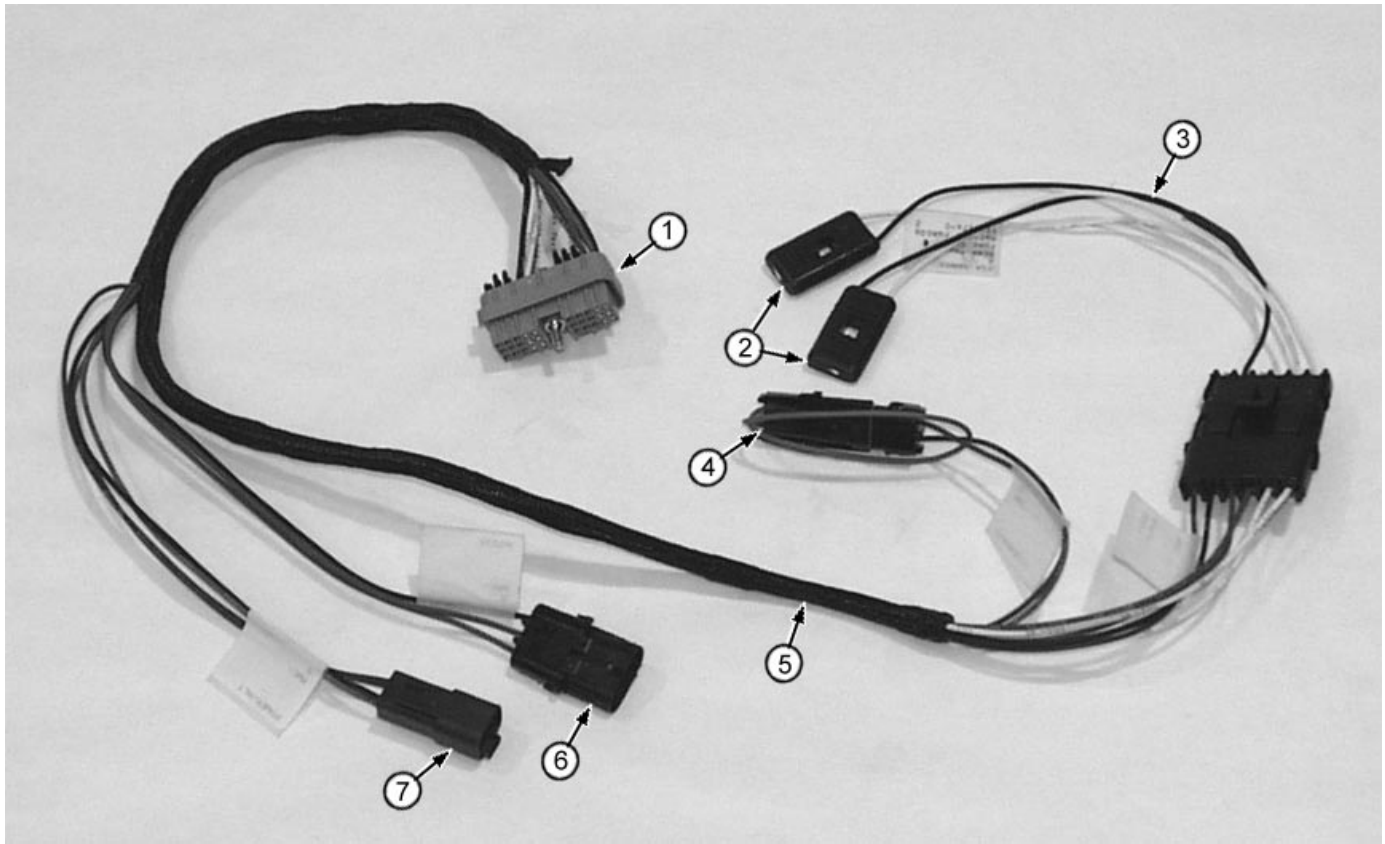

T128057B -UN-03FEB00

1—Connector to Communications Controller

2—LED Lights
3—LED Light Harness
4—Diagnostic Connector

5—Communications Controller Harness
6—Auxiliary Connectors

7—4-Pin Connector to Power Harness

1. Route communications controller harness so the LED lights (4) and diagnostic connector (5) are protected from damage and yet accessible. LED

lights and diagnostic connector will be used for troubleshooting the system.

Continued on next page

CED,TX13067,2599 -19-22NOV99-1/2

INSTALLING POWER HARNESS

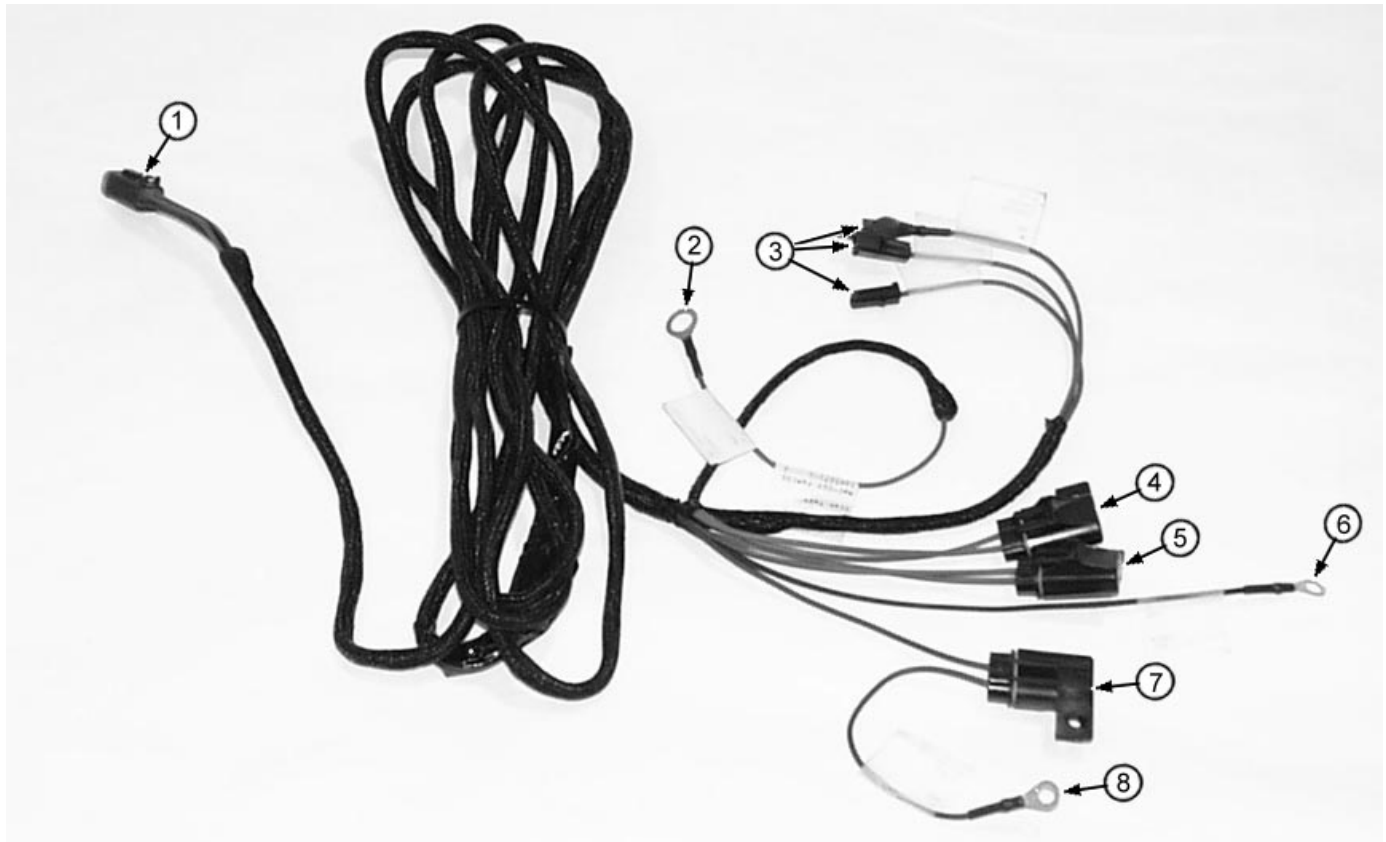

VCA10002 Power Harness

- 1—4-pin Connector to Communications Controller
- 2—B+ Unswitched Power (Red Wire)
- 3—W+/R+ Engine Running (Purple Wire) Connectors (Use whichever needed)

- 4—B+ Unswitched Power Fuse
- 5—W+/R+ Engine Running Fuse
- 6—GND (Ground) (Black Wire)
- 7—D+ Switched Power Fuse

- 8—D+ Switched Power (Brown Wire)

Power Harness Electrical Requirements	
Wire Color	Machine Connection
Red	Constant positive (+) power source. 12—24 volts typical, 36 volts maximum. With key ON or OFF
Brown	Positive (+) power source. 12—24 volts typical, 36 volts maximum. Only with key ON (0 volts with key OFF.).
Purple	Positive (+) power source. 6—24 volts typical, 36 volts maximum. With engine running.
Black	Ground (GND)

Continued on next page

CED, TX13067, 2550 -19-26OCT99-1/5

CONNECTING B+ UNSWITCHED POWER (RED WIRE)



CAUTION: Before doing any electrical maintenance, turn battery disconnect switch OFF or disconnect negative (-) battery cable. Damage to electrical components or personal injury could result if a power wire is shorted to ground.

This connection supplies battery voltage to the communications controller regardless of key switch position.

Typical connection for unswitched power is B+ terminal on the alternator.

If connecting B+ Red wire terminal to an existing machine wire, use VCU10018 Connector and T178552 Heat Shrink Tubing.

CONNECTING D+ SWITCHED POWER (BROWN WIRE)

This connection supplies switched power to the communications controller.

Connect to a place where battery power is present with the key switch ON and not present with the key switch OFF.

Typical connection for switched power is D+ terminal on the alternator.

1. Connect D+ Brown to switched power source. If splicing into existing machine wire, use VCU10018 Connector and T178552 Heat Shrink Tubing.
2. If alternator does not have a D+ terminal, locate another source for switched power.

Use a VCU10018 butt splice to connect to an existing wire or terminal.

Cover splice with heat shrink tubing to prevent shorting to ground.

CONNECTING GROUND (GND) (BLACK WIRE)

This connection provides a ground for the system.

Connect Black Ground wire to alternator case or machine frame.

CONNECTING W+/R+ ENGINE RUNNING (PURPLE WIRE)

This connection provides the communications controller with a signal indicating the engine is running. A minimum of 6 volts is required.

Typical source for this signal is the W+ or R+ terminal on the alternator. This provides a signal when the engine is running.

Three W+/R+ Purple wires are included in the harness, each has a different connector. Choose the one that fits your alternator. Tie the other Purple wires to the harness so they won't be damaged during normal operation.

If Machine Has:	Connect Purple Wire To:
W+ terminal on alternator	W+ alternator terminal
R+ terminal on alternator	R+ alternator terminal
If alternator does not have above terminals	Switched power source

Continued on next page

CED, TX13067,2550 -19-26OCT99-2/5

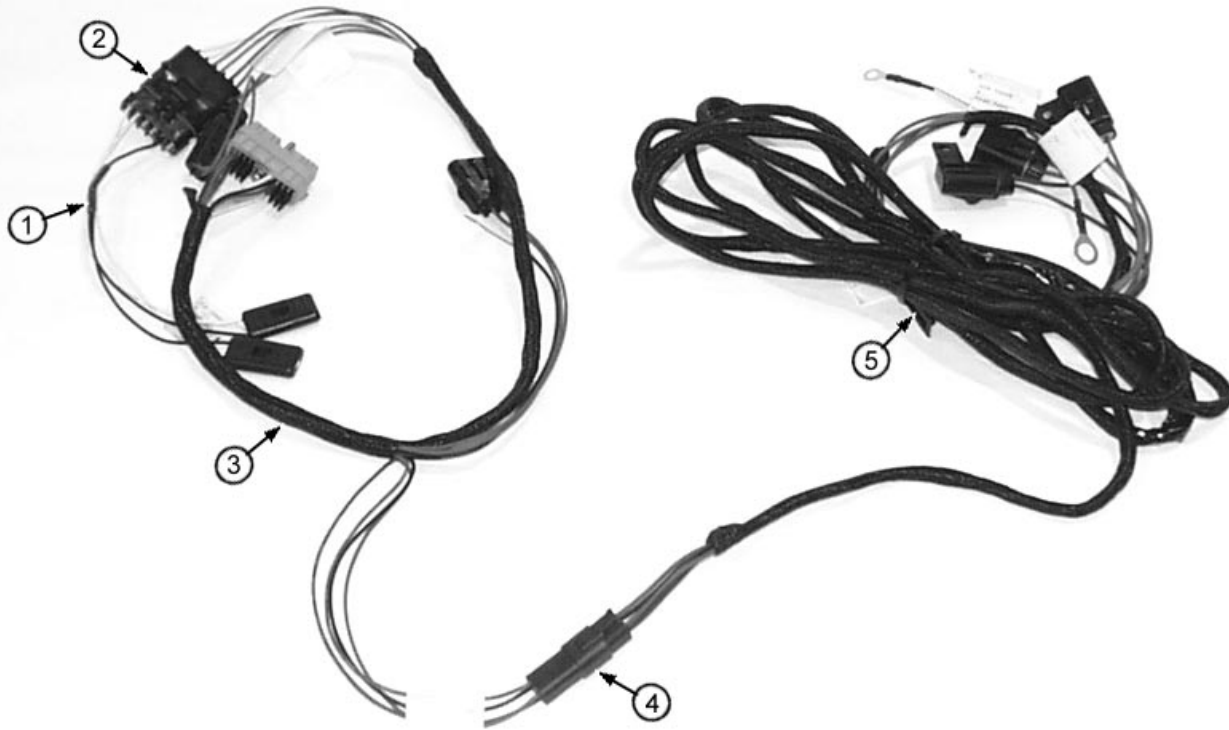

LED Light Harness, Communications Controller Harness and Power Harness

1—VCA10003 LED Light
Harness
2—6-pin Connector

3—VCA10001
Communications
Controller Harness

4—4-pin Connector
5—VCA10002 Power
Harness

CONNECTING AND ROUTING HARNESSES TO COMMUNICATIONS CONTROLLER

1. **IMPORTANT:** Route harnesses away from hot, moving or vibrating components. Do not attach harnesses to hydraulic hoses. Avoid sharp edges and use grommets and tie bands where needed.

bands to secure harnesses to existing harnesses where possible.

- 2. Connect LED light harness 6-pin connector (2) to communications controller harness.
- 3. Connect power harness 4-pin connector (4) to communications controller harness 4-pin connector.

Route communications controller harness to communications controller mounting location. Use tie

Continued on next page

CED, TX13067,2550 -19-26OCT99-3/5

T128062B -UN-03FEB00

TYPICAL CONNECTIONS TO AN ALTERNATOR

Shown are typical connections to a Bosch alternator.

Terminal location on your alternator may be different, but they should be marked the same.

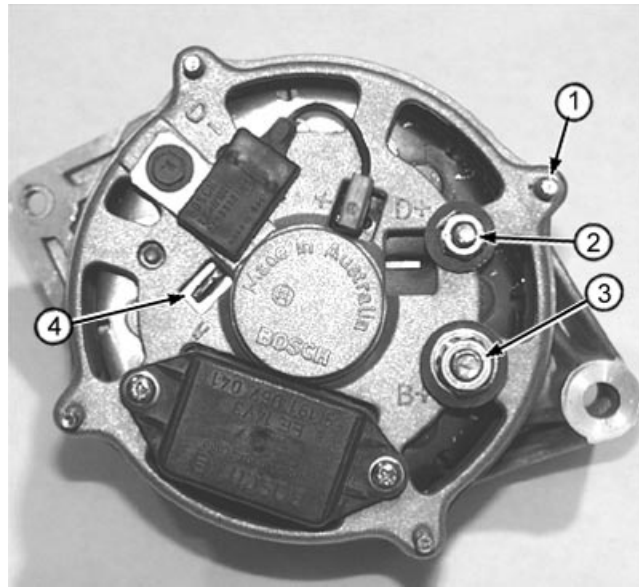

Typical Alternator Terminals

- 1—GND Terminal
- 2—D+ Terminal
- 3—B+ Terminal
- 4—W Terminal

CED, TX13067,2550 -19-26OCT99-4/5

1. Connect B+ Red wire to B+ terminal on alternator.
2. Connect D+ Brown wire to D+ alternator terminal.
3. Connect GND Black wire to alternator case or machine frame.
4. Connect W+/R+ Purple wire to W+ or R+ alternator terminal.
5. Use tie bands to secure harnesses to existing harnesses where possible.

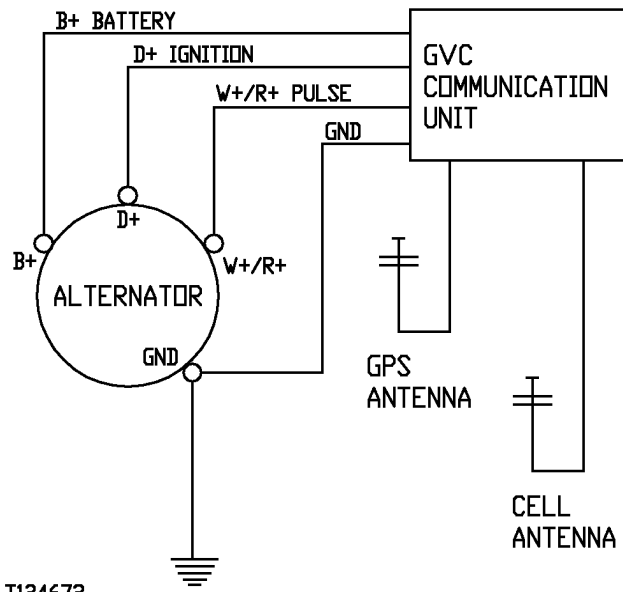

T124672

Typical Connection To Alternator

T124672 -19-09DEC99

CED, TX13067,2550 -19-26OCT99-5/5

SELECTING MOUNTING LOCATION FOR ANTENNAS

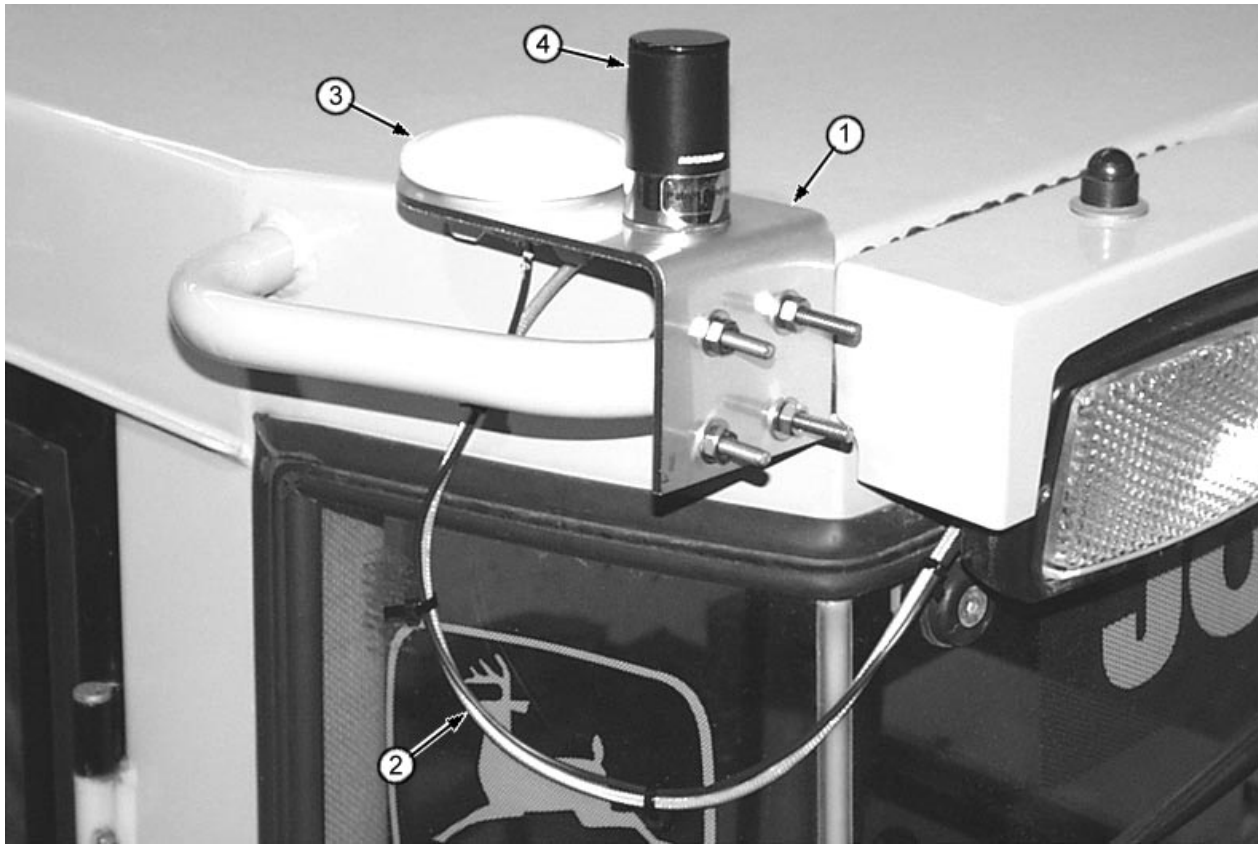

1—VCA10005 Antenna
Mounting Bracket
2—Drip Loop in Antenna
Cables

3—VCU10008 GPS Antenna
4—VCU10034 Cellular
Antenna

⚠ CAUTION: Never modify by drilling or welding a Roll Over Protection Structure (ROPS). Structure may fail during a roll over accident.

The Falling Objects Protection Structure (FOPS) may be modified by drilling holes up to 25mm (1.0 in.) diameter.

FCC Antenna Warning Label

While the device is in operation, a separation of at least 500 mm (20 in.) must be maintained between antennae and the body of the user or nearby persons in order to meet the FCC RF exposure guidelines.

- Antennas must be mounted outside the cab at least

500 mm (20 in.) away from the machine operator.

- Cellular antenna should be mounted using VCA10005 mounting bracket if possible.
- Entire length of cellular antenna must be mounted above cab roof or any structure within 300 mm (12 in.).
- Mount cellular antenna (4) at least 300mm (12 in.) from upright metallic structures, like mirrors. Center of the cab roof or attached to a roof handhold is an ideal location.
- Mount the GPS antenna (3) in an area that allows an unobstructed view of the sky. Mounting near the cellular antenna is OK. Use Antenna Mounting Bracket (1) when possible.

Continued on next page

CED,TX13067,2597 -19-19NOV99-1/2

- Antennas may be mounted directly to a cab or ROPS roof. Ensure all gaskets and O-Rings are installed under antennas to prevent water entry. Petroleum jelly may be used to prevent O-Rings from slipping out of position. Ensure adequate ground plane is available (See Installing Antennas Through Machine or Metal Panel).
- Where antenna cables go through the roof or steel panels, install convoluted tubing or grommets to prevent chaffing or shorting. Make “drip loops” (2) in cables to prevent water from running down the cables and into the cab.
- Mount antennas where they are best protected from damage.
- Antenna height must not exceed overall height limitations for transporting the machine.
- Route antenna cables with existing cables or harnesses.

CED,TX13067,2597 -19-19NOV99-2/2

ASSEMBLING ANTENNAS USING MOUNTING BRACKET

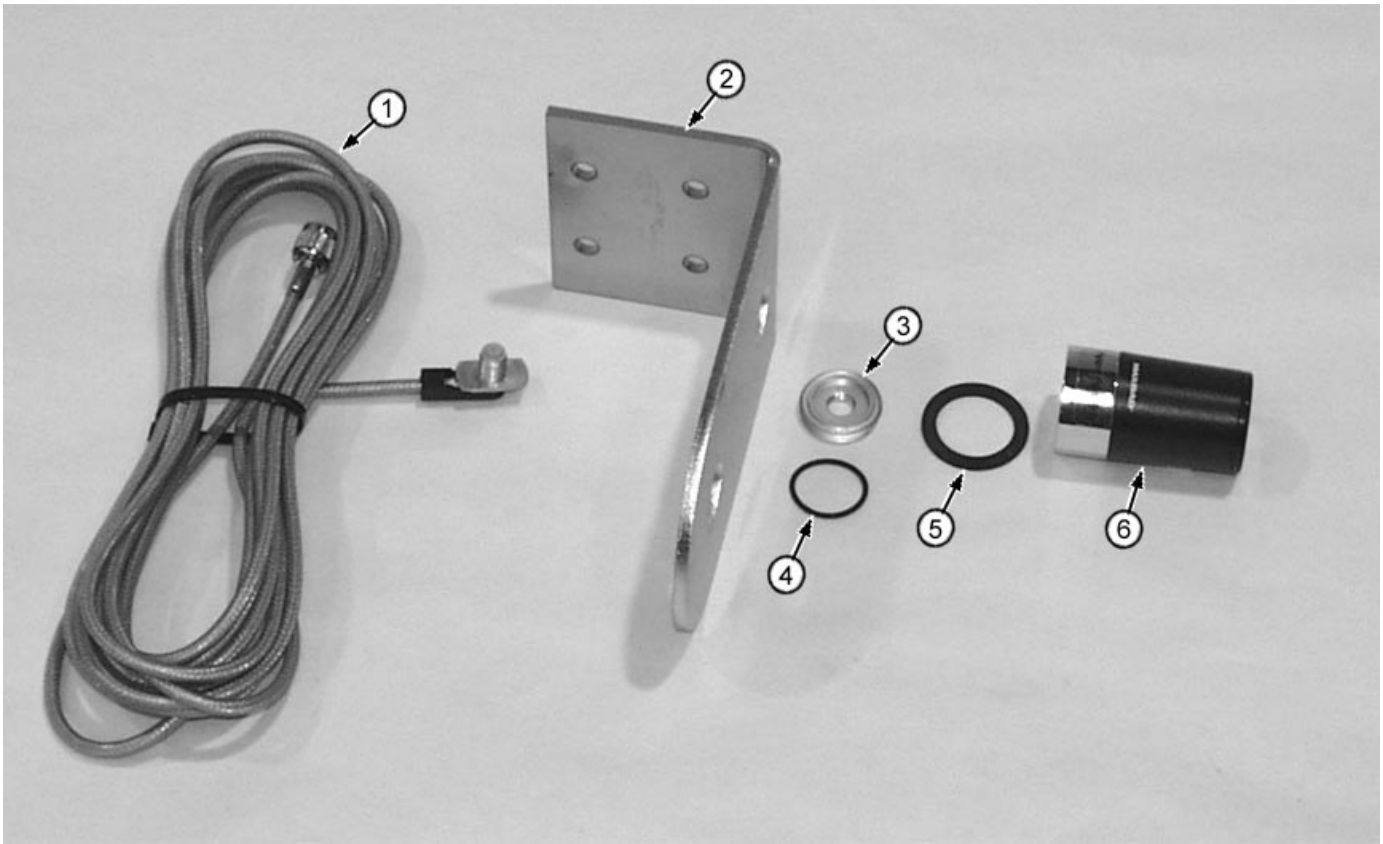

1—VCU10034 Cellular
Antenna Cable
2—VCA10005 Antenna
Mounting Bracket

3—Nut
4—O-ring
5—Rubber Washer
6—Cellular Antenna

7—Spacer

Continued on next page

CEDEX, TX13067, 2552 -19-27OCT99-1/6

T128019B -UN-02FEB00

ASSEMBLING CELLULAR ANTENNA

1. Insert cable end (1) through small hole in bracket (3).
2. Use tie bands (2) to attach cable to bracket.

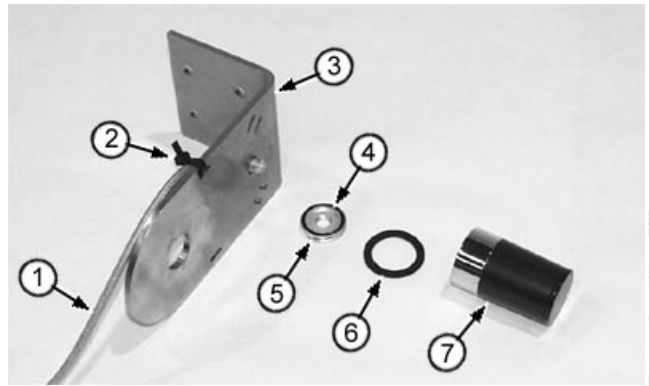

T128081B -UN-03FEB00

- 1—VCU10034 Cellular Antenna Cable
- 2—Tie Band
- 3—VCA10005 Antenna Mounting Bracket
- 4—O-ring
- 5—Nut
- 6—Rubber Washer
- 7—VCU10035 Cellular Antenna

CED, TX13067,2552 -19-27OCT99-2/6

3. Screw nut (4) over cable end. Apply petroleum jelly to O-ring to ensure it stays in groove.
4. Apply petroleum jelly to rubber washer to prevent it from rolling. Install rubber washer (5) over nut (4). Screw antenna (6) onto nut. Hand tighten only.

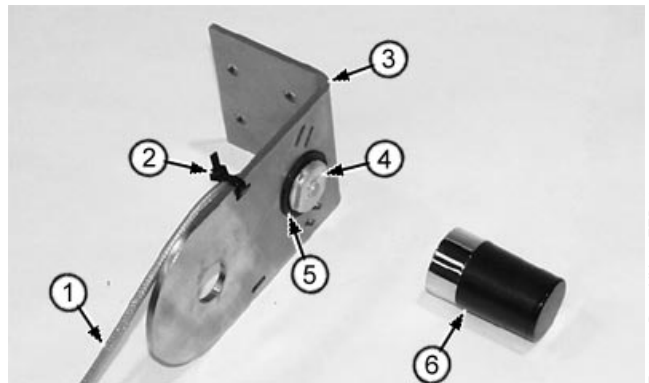

T128075B -UN-03FEB00

- 1—VCU10034 Cellular Antenna Cable
- 2—Tie Band
- 3—VCA10005 Antenna Mounting Bracket
- 4—Nut
- 5—Rubber Washer
- 6—VCU10035 Cellular Antenna

Continued on next page

CED, TX13067,2552 -19-27OCT99-3/6

ASSEMBLING GPS ANTENNA

1. Pass cable (1) through O-ring (4), Bracket (3) and Nut (2). Screw nut onto antenna, ensure O-ring stays in step on antenna.
2. Secure antenna cables as needed.
3. Install additional tie bands on cables as needed to keep them neatly together.

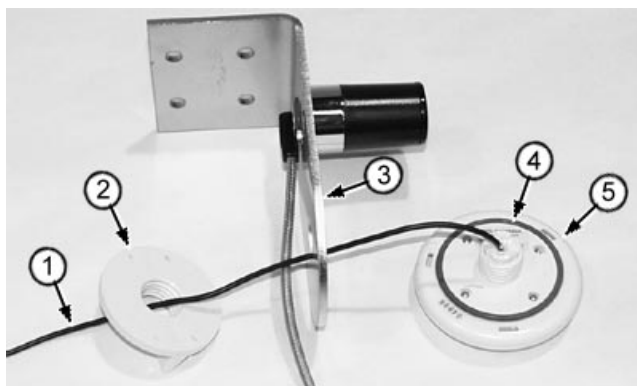

- 1—Cable
- 2—Nut
- 3—VCU10005 Antenna Mounting Bracket
- 4—O-Ring
- 5—VCU10008 GPS Antenna

Continued on next page

CED, TX13067,2552 -19-27OCT99-4/6

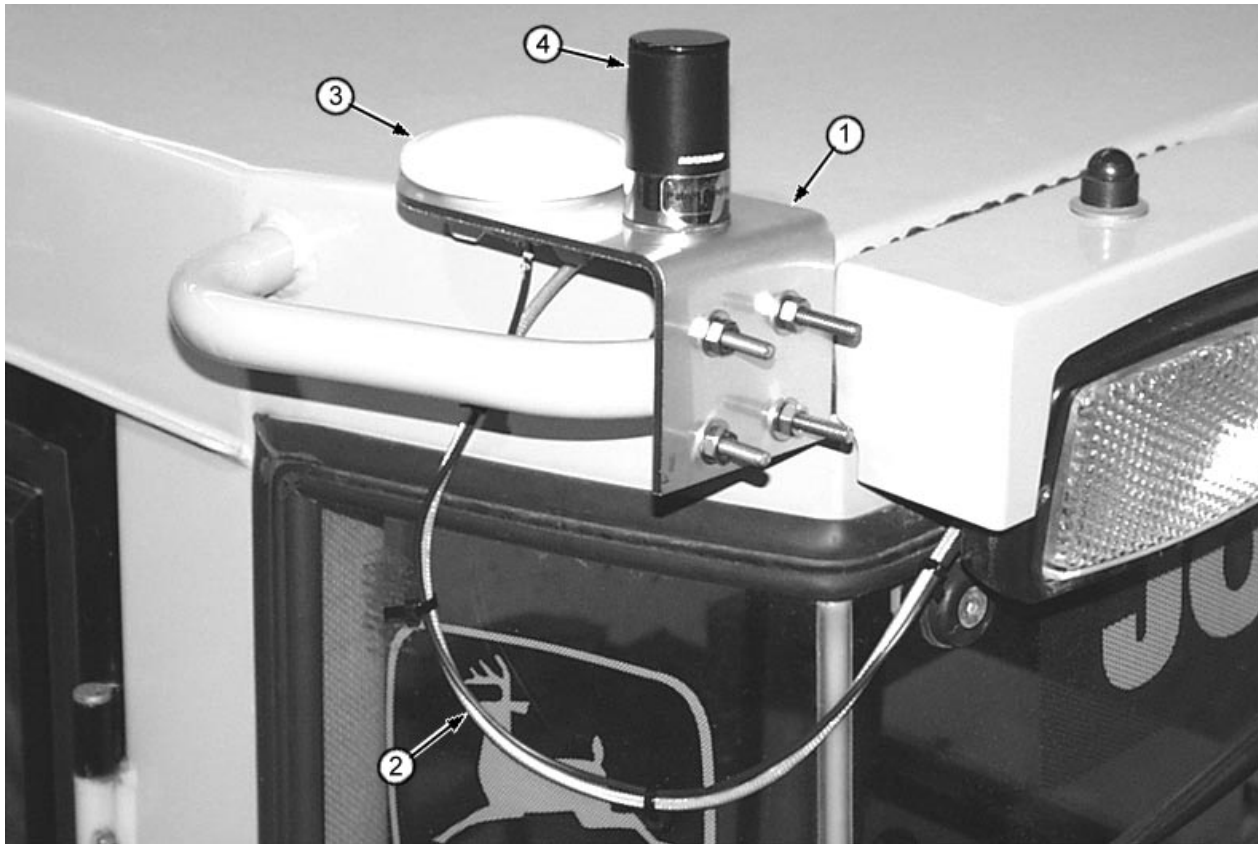

Typical Bracket Mount

- 1—VCU10005 Antenna Mounting Bracket
- 2—Drip Loop in Antenna Cables
- 3—VCU10008 GPS Antenna
- 4—VCU10035 Cellular Antenna

4. Attach bracket and antennas to hand hold or other suitable location using U-bolts.

Mount cellular antenna (4) at least at least 300 mm (12 in.) from upright structures like mirrors.

Mount antenna at least 500 mm (20 in.) from operators body.

5. Make a drip loop (2) to prevent water from running along the cables into the cab.

FCC Antenna Warning Label

While the device is in operation, a separation of at least 500 mm (20 in.) must be maintained between antennae and the body of the user or nearby persons in order to meet the FCC RF exposure guidelines.

Continued on next page

CED, TX13067,2552 -19-27OCT99-5/6

T128018B -UN-02FEB00

- Route both the cellular and GPS antenna cables to the communication controller.

Connect cables to controller. Cable ends are different to prevent connecting them incorrectly.

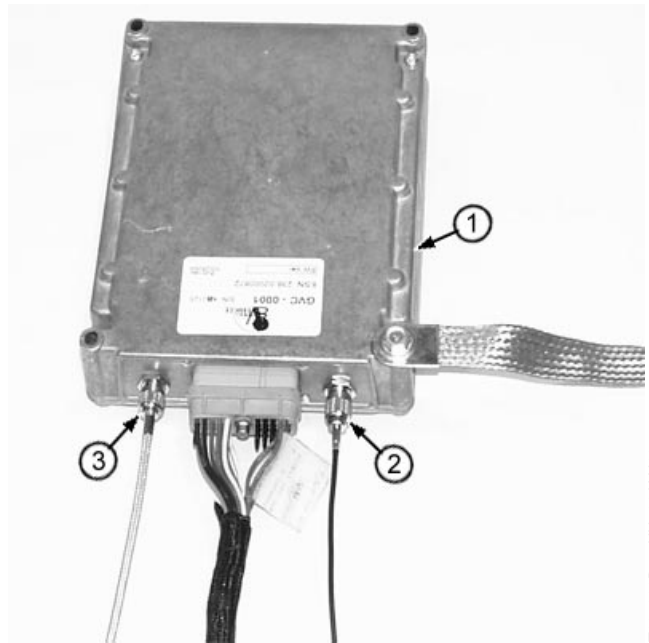

T1127600B -UN-22JAN00

- 1—Communications Controller
- 2—VCU10008 GPS Antenna Cable
- 3—VCU10004 Cellular Antenna Cable

CED,TX13067,2552 -19-27OCT99-6/6

INSTALLING ANTENNAS THROUGH MACHINE ROOF OR METAL PANEL



CAUTION: Never modify a Roll Over Protection Structure (ROPS) by drilling or welding. Structure may fail during a roll over accident.

The Falling Objects Protection Structure (FOPS) may be modified by drilling holes up to 25mm (1.0 in.) diameter.

- Choose a place on the machine roof or other suitable panel where the antennas are protected and the cables will reach the communications controller.

For proper operation, the antenna must be mounted on a metal surface (like a steel roof).

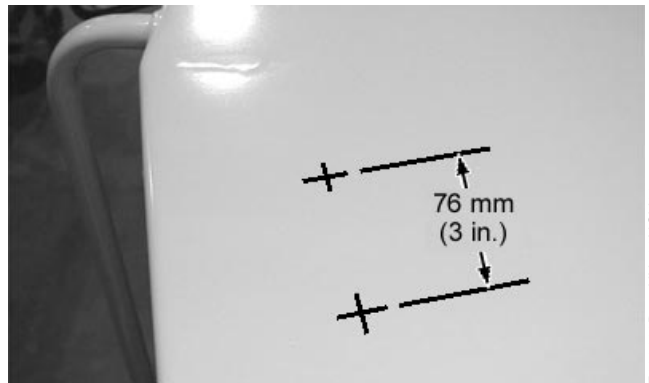

T126133B -UN-22NOV99

Continued on next page

CED,TX13067,2598 -19-22NOV99-1/2

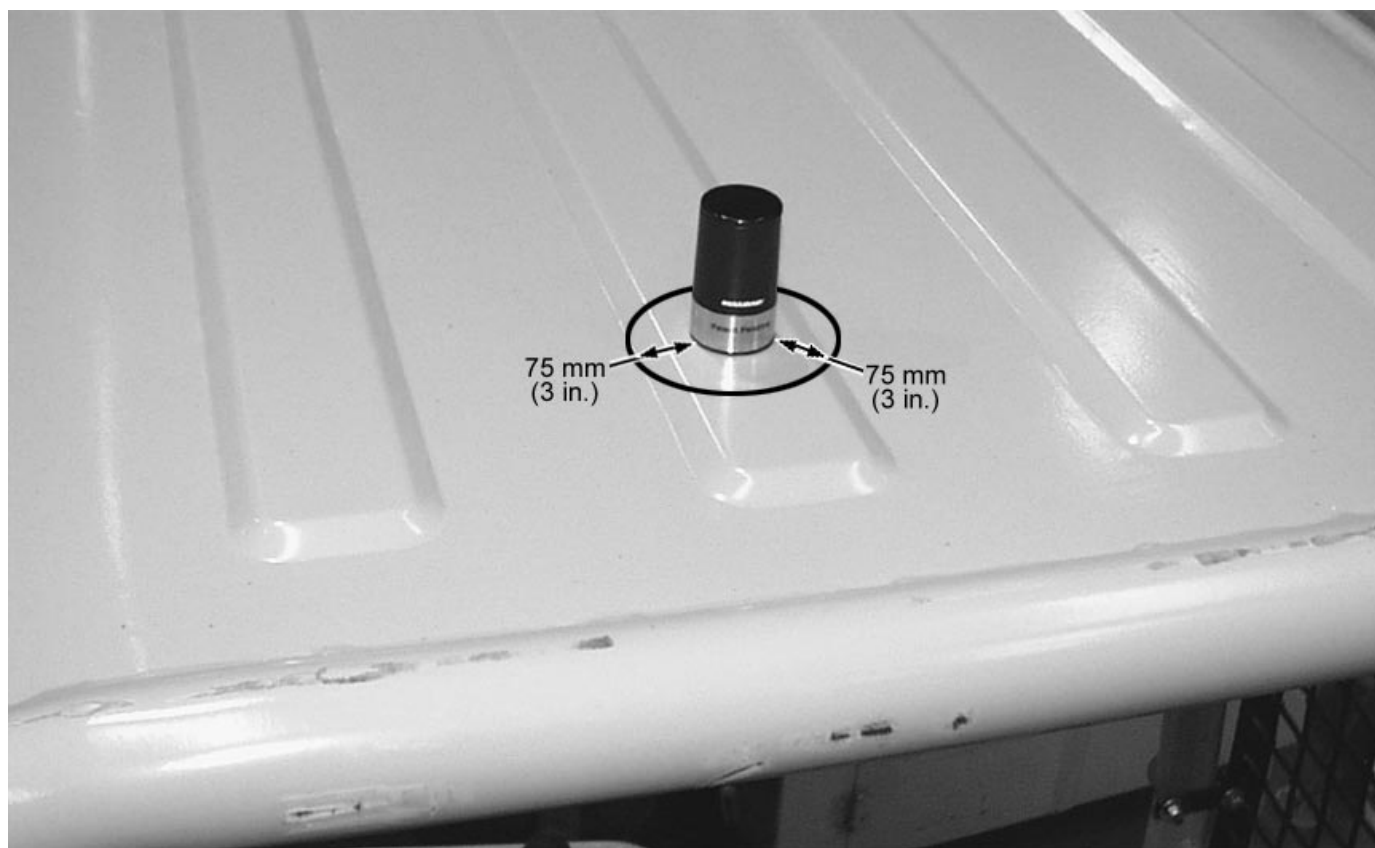

T128065B -UN-03FEB00

Cellular Antenna Ground Plane

- At least 75 mm (3.0 in.) around the cellular antenna in every direction must be free of other metal items like hand holds, beacons or other antennas. The area must be flat to ensure a good ground plane.
2. Mark the roof or panel so the holes will be at least 76 mm (3 in.) apart. (The GPS antenna mounting hole location is OK).
 3. Drill one hole 3/8 in. for the cellular antenna.
 4. Drill the other hole 7/8 in. for the GPS antenna.
 5. Assemble antennas through roof following guidelines in Assembling Antennas Using Mounting Bracket.

CED, TX13067, 2598 -19-22NOV99-2/2

SYSTEM TESTING

To determine if unit is functioning properly, move machine outdoors with no overhead obstructions or power lines.

1. Engine OFF.
2. Key ON.
3. Observe CELL and GPS LED lights as ignition key is turned ON. Both LED lights must be ON for 1—5 seconds indicating power to the communications controller. LED lights may go OFF indicating no cellular service or GPS lock.
4. The system will now test CELL and GPS functionality. Both LED lights will come ON indicating successful completion of this test. This may take 10 minutes.

CED, TX13067,2460 -19-03AUG99-1/2

5. Carefully remove GPS antenna cable (2) from communications controller (1). The GPS LED light (3) should go OFF to indicate No GPS lock.
 6. With GPS antenna cable disconnected, start engine. LED light should come ON indicating the engine is running.
 7. Stop engine. Connect GPS antenna cable.
- System is OK.

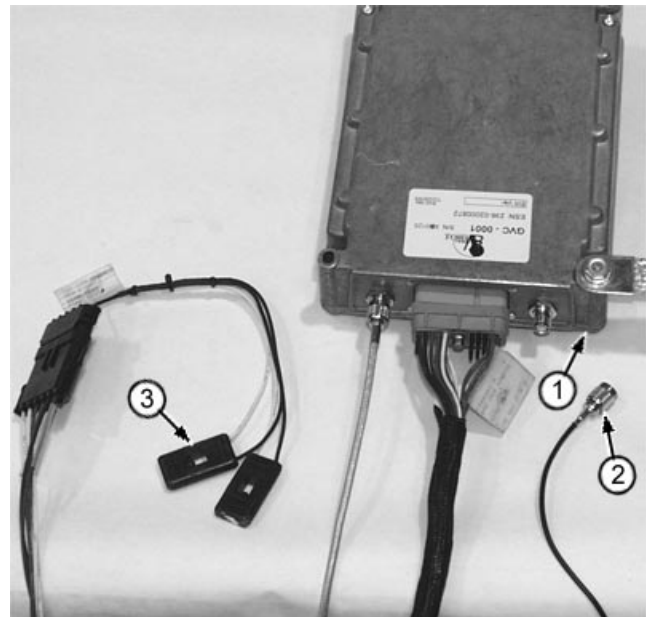

T1127603B -UN-22JAN00

CED, TX13067,2460 -19-03AUG99-2/2

VEHICLE HOURS SYNCHRONIZATION

When installation is complete, vehicle hours must be synchronized with communications controller.

Record vehicle hours, date and time of synchronization on DeereTrax® Installation Record.

When DeereTrax™ Installation Record is complete Fax it to the number on the record.

To synchronize the communications controller:

CED,TX13067,2595 -19-18NOV99-1/3

1. Key switch ON. Wait for both LED lights (1 and 2) to come ON.

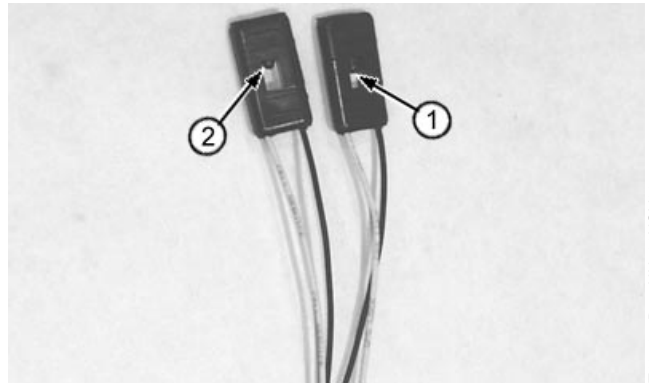

T125457B -UN-23NOV99

1—GPS Light
2—CELL Light

Continued on next page

CED,TX13067,2595 -19-18NOV99-2/3

2. Disconnect diagnostic connector (2), wait more than six seconds.
3. Connect diagnostic connector.
4. Watch LED lights (GPS and CELL lights) (1).
5. GPS light goes OFF.
6. CELL light remains ON.
7. Cell light goes OFF.
8. When both lights come back ON, system is OK.
9. If both lights DO NOT come back ON, go to Problem Diagnosis.

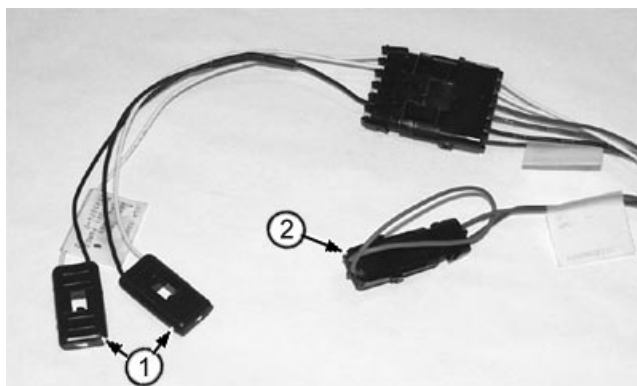

T128066B -UN-03FEB00

LED Lights and Diagnostic Connector

- 1—GPS and CELL Lights
- 2—Diagnostic Connector

CED, TX13067, 2595 -19-18NOV99-3/3

PROBLEM DIAGNOSIS

Symptom	Problem	Solution
LED Lights Do Not Come ON When Key Is Turned ON	Blown fuses	Check fuses in power harness
	Connection to alternator incorrect	Check harness connections to terminals on alternator.
		B+ unswitched power (Red Wire) must be connected to positive (+) power source.
		GND (Black wire) must be connected to clean frame ground.
	Power harness failure	D+ switched power (Brown Wire) must be connected to positive (+) power source. Voltage with key ON.
		Check Brown wire in four-pin power harness connector. It must have voltage only when the key is ON.
Check Red wire in four-pin power harness connector. It must have voltage all the time.		
Check Black wire in four-pin power harness connector. It must have a good connection to frame ground.		
Communications controller harness failure	Check pin 1A (Red wire) in connector to communications controller. It must have battery voltage at all times.	
	Check pin A3 (Brown wire) for battery voltage only when key is ON.	
	Check pin 2A (Black wire) for continuity to frame ground.	

Continued on next page

CED, TX13067, 2532 -19-05OCT99-1/3

Symptom	Problem	Solution
Cellular Connection LED Does Not Come ON	LED harness failure	<p>Check for battery voltage on both Yellow wires in six-pin connector on communications controller harness as key is turned ON (Use the Black wire in that connector as a ground reference).</p> <p>Voltage may fluctuate for five seconds, but should remain constant after that.</p> <p>If voltage is present on yellow wires, but LED lights aren't ON, harness has failed. replace harness.</p>
	Communications controller failure	If voltages in previous checks are correct, communications controller has failed.
	Cellular antenna cable connection	Check cellular cable connection at antenna and communications controller.
	Cellular antenna failure	Check general antenna condition. Replace if damage is seen.
	Lack of cellular service	Assure cellular service is available, call with a hand-held cellular phone to be sure. Perform procedure to activate cellular service. If service is still not activated, call Customer Support Center at 1-800-939-0805
GPS LED Light Does Not Come ON (Engine OFF)	Communications controller failure	Replace antenna and cable. Verify cellular phones will work in that location. If LEDs do not come ON and voltage checks are OK, replace communications controller.
	Obstructed view of sky	Move machine to an open location away from buildings and overhead power lines.

Continued on next page

CED, TX13067, 2532 -19-05OCT99-2/3

Symptom	Problem	Solution
GPS LED Light Does Not Come ON (Engine Running)	GPS antenna failure	Check general antenna condition, replace if damage is seen.
	GPS antenna cable connection	Check GPS antenna cable connections at antenna and communications controller.
	Communications controller failure	Replace antenna and cable. If LEDs do not come ON and voltage checks are OK, replace communications controller.
	Blown fuse	Check W+/R+ Engine Running Fuse in Power Harness
	Incorrect voltage or poor connection at engine running signal source	With engine running a minimum of 6 volts must be present at W+/R+ Engine Running connection to engine (Purple wire).
	Power harness failure	With engine running, check for a minimum of 6 volts on Purple wire in 4-pin connector of power harness.
	Communications controller harness failure	With engine running, check for a minimum of 6 volts on pin B-1 (Purple wire) in connector of communications controller harness.
	Communications controller failure	If voltages are correct, communications controller has failed.

CED, TX13067, 2532 -19-05OCT99-3/3

