

# Dell™ User's Guide

---

## Notes, Notices, and Cautions



**NOTE:** A NOTE indicates important information that helps you make better use of your computer.



**NOTICE:** A NOTICE indicates either potential damage to hardware or loss of data and tells you how to avoid the problem.



**CAUTION:** A CAUTION indicates a potential for property damage, personal injury, or death.

---

## Abbreviations and Acronyms

For a complete list of abbreviations and acronyms, see the [Glossary](#).

If you purchased a Dell™ n Series computer, any references in this document to Microsoft® Windows® operating systems are not applicable.

---

**Information in this document is subject to change without notice.  
© 2003 Dell Inc. All rights reserved.**

Reproduction in any manner whatsoever without the written permission of Dell Inc. is strictly forbidden.

Trademarks used in this text: *Dell*, the *DELL* logo, *Latitude*, *Dell Precision*, *OptiPlex*, *Inspiron*, *Dimension*, *Dell Travellite*, and *DellNet* are trademarks of Dell Inc.; *Intel* and *Pentium* are registered trademarks and *Intel SpeedStep* and *Centrino* are trademarks of Intel Corporation; *Microsoft*, *Windows*, *Windows NT*, and *MS-DOS* are registered trademarks of Microsoft Corporation; *Bluetooth* is a trademark owned by Bluetooth SIG, Inc. and is used by Dell Inc. under license; *ENERGY STAR* is a registered trademark of the U.S. Environmental Protection Agency. As an ENERGY STAR Partner, Dell Inc. has determined that this product meets the ENERGY STAR guidelines for energy efficiency.

Other trademarks and trade names may be used in this document to refer to either the entities claiming the marks and names or their products. Dell Inc. disclaims any proprietary interest in trademarks and trade names other than its own.

**Model PP10L**

**September 2003 P/N M1794 Rev. A00**

# Glossary

[A](#) [B](#) [C](#) [D](#) [E](#) [F](#) [G](#) [H](#) [I](#) [K](#) [L](#) [M](#) [N](#) [O](#) [P](#) [R](#) [S](#) [T](#) [U](#) [V](#) [W](#) [X](#) [Z](#)

Terms in this Glossary are provided for informational purposes only and may or may not describe features included with your particular computer.

---

## A

**AC** — alternating current — The form of electricity that powers your computer when you plug the AC adapter power cable in to an electrical outlet.

**ACPI** — advanced configuration and power interface — A power management specification that enables Microsoft® Windows® operating systems to put a computer in standby or hibernate mode to conserve the amount of electrical power allocated to each device attached to the computer.

**AGP** — accelerated graphics port — A dedicated graphics port that allows system memory to be used for video-related tasks. AGP delivers a smooth, true-color video image because of the faster interface between the video circuitry and the computer memory.

**antivirus software** — A program designed to identify, quarantine, and/or delete viruses from your computer.

**APR** — advanced port replicator — A docking device that allows you to conveniently use a monitor, keyboard, mouse, and other devices with your portable computer.

**ASF** — alert standards format — A standard to define a mechanism for reporting hardware and software alerts to a management console. ASF is designed to be platform- and operating system-independent.

---

## B

**backup** — A copy of a program or data file on a floppy disk, CD, or hard drive. As a precaution, back up the data files from your hard drive regularly.

**battery** — An internal power source used to operate portable computers when not connected to an AC adapter and an electrical outlet.

**battery life span** — The length of time (years) during which a portable computer battery is able to be depleted and recharged.

**battery operating time** — The length of time (minutes or hours) that a portable computer battery holds a charge while powering the computer.

**BIOS** — basic input/output system — A program (or utility) that serves as an interface between the computer hardware and the operating system. Unless you understand what effect the settings have on the computer, do not change the settings for this program. Also referred to as the *system setup program*.

**bit** — The smallest unit of data interpreted by your computer.

**Bluetooth™** — A wireless technology standard for short-range (9 m [29 feet]) networking devices that allows for enabled devices to automatically recognize each other.

**boot sequence** — Specifies the order of the devices from which the computer attempts to boot.

**bootable CD** — A CD that you can use to start your computer. In case your hard drive is damaged or your computer has a virus, ensure that you always have a bootable CD or floppy disk available. Your *Drivers and Utilities* or Resource CD is a bootable CD.

**bootable disk** — A disk that you can use to start your computer. In case your hard drive is damaged or your computer has a virus, ensure that you always have a bootable CD or floppy disk available.

**bps** — bits per second — The standard unit for measuring data transmission speed.

**BTU** — British thermal unit — A measurement of heat output.

**bus** — A communication pathway between the components in your computer.

**bus speed** — The speed, given in MHz, that indicates how fast a bus can transfer information.

**byte** — The basic data unit used by your computer. A byte is usually equal to 8 bits.

---

## C

**C** — Celsius — A temperature measurement system where 0° is the freezing point and 100° is the boiling point of water.

**cache** — A special high-speed storage mechanism which can be either a reserved section of main memory or an independent high-speed storage device. The cache enhances the efficiency of many microprocessor operations.

L1 cache — Primary cache stored inside the microprocessor.

L2 cache — Secondary cache which can either be external to the microprocessor or incorporated into the microprocessor architecture.

**carnet** — An international customs document that facilitates temporary imports into foreign countries. Also known as a *merchandise passport*.

**CD** — compact disc — An optical form of storage media, typically used for audio and software programs.

**CD drive** — A drive that uses optical technology to read data from CDs.

**CD player** — The software used to play music CDs. The CD player displays a window with buttons that you use to play a CD.

**CD-R** — CD recordable — A recordable version of a CD. Data can be recorded only once onto a CD-R. Once recorded, the data cannot be erased or written over.

**CD-RW** — CD rewritable — A rewritable version of a CD. Data can be written to a CD-RW disc, and then erased and written over (rewritten).

**CD-RW drive** — A drive that can read CDs and write to CD-RW (rewritable CDs) and CD-R (recordable CDs) discs. You can write to CD-RW discs multiple times, but you can write to CD-R discs only once.

**CD-RW/DVD drive** — A drive, sometimes referred to as a combo drive, that can read CDs and DVDs and write to CD-RW (rewritable CDs) and CD-R (recordable CDs) discs. You can write to CD-RW discs multiple times, but you can write to CD-R discs only once.

**clock speed** — The speed, given in MHz, that indicates how fast computer components that are connected to the system bus operate.

**COA** — Certificate of Authenticity — The Windows alpha-numeric code located on a sticker on your computer. You may need the COA to complete the operating system setup or reinstallation. Also referred to as the *Product Key* or *Product ID*.

**Control Panel** — A Windows utility that allows you to modify operating system and hardware settings, such as display settings.

**controller** — A chip that controls the transfer of data between the microprocessor and memory or between the microprocessor and devices.

**CRIMM** — continuity rambus in-line memory module — A special module that has no memory chips and is used to fill unused RIMM slots.

**cursor** — The marker on a display or screen that shows where the next keyboard, touch pad, or mouse action will occur. It often is a blinking solid line, an underline character, or a small arrow.

---

## D

**DDR SDRAM** — double-data-rate SDRAM — A type of SDRAM that doubles the data burst cycle, improving system performance.

**device** — Hardware such as a disk drive, printer, or keyboard that is installed in or connected to your computer.

**device driver** — See *driver*.

**DIN connector** — A round, six-pin connector that conforms to DIN (Deutsche Industrie-Norm) standards; it is typically used to connect PS/2 keyboard or mouse cable connectors.

**disk striping** — A technique for spreading data over multiple disk drives. Disk striping can speed up operations that retrieve data from disk storage. Computers that use disk striping generally allow the user to select the data unit size or stripe width.

**DMA** — direct memory access — A channel that allows certain types of data transfer between RAM and a device to bypass the microprocessor.

**docking device** — See *APR*.

**DMTF** — Distributed Management Task Force — A consortium of hardware and software companies who develop management standards for distributed desktop, network, enterprise, and Internet environments.

**domain** — A group of computers, programs, and devices on a network that are administered as a unit with common rules and procedures for use by a specific group of users. A user logs on to the domain to gain

access to the resources.

**DRAM** — dynamic random-access memory — Memory that stores information in integrated circuits containing capacitors.

**driver** — Software that allows the operating system to control a device such as a printer. Many devices do not work properly if the correct driver is not installed in the computer.

**DSL** — Digital Subscriber Line — A technology that provides a constant, high-speed Internet connection through an analog telephone line.

**dual display mode** — A display setting that allows you to use a second monitor as an extension of your display. Also referred to as *extended display mode*.

**DVD** — digital versatile disc — A disc usually used to store movies. DVDs are double-sided, whereas CDs are single-sided. DVD drives read most CD media as well.

**DVD drive** — A drive that uses optical technology to read data from DVDs and CDs.

**DVD player** — The software used to watch DVD movies. The DVD player displays a window with buttons that you use to watch a movie.

**DVD+RW** — DVD rewritable — A rewritable version of a DVD. Data can be written to a DVD+RW disc, and then erased and written over (rewritten). (DVD+RW technology is different from DVD-RW technology.)

**DVD+RW drive** — A drive that can read DVDs and most CD media and write to DVD+RW (rewritable DVDs) discs.

**DVI** — digital video interface — A standard for digital transmission between a computer and a digital video display; the DVI adapter works through the computer's integrated graphics.

---

## E

**ECC** — error checking and correction — A type of memory that includes special circuitry for testing the accuracy of data as it passes in and out of memory.

**ECP** — extended capabilities port — A parallel connector design that provides improved bidirectional data transmission. Similar to EPP, ECP uses direct memory access to transfer data and often improves performance.

**EIDE** — enhanced integrated device electronics — An improved version of the IDE interface for hard drives and CD drives.

**EMI** — electromagnetic interference — Electrical interference caused by electromagnetic radiation.

**ENERGY STAR®** — Environmental Protection Agency requirements that decrease the overall consumption of electricity.

**EPP** — enhanced parallel port — A parallel connector design that provides bidirectional data transmission.

**ESD** — electrostatic discharge — A rapid discharge of static electricity. ESD can damage integrated circuits found in computer and communications equipment.

**expansion card** — A circuit board that installs in an expansion slot on the system board in some computers, expanding the capabilities of the computer. Examples include video, modem, and sound cards.

**expansion slot** — A connector on the system board (in some computers) where you insert an expansion card, connecting it to the system bus.

**Express Service Code** — A numeric code located on a sticker on your Dell™ computer. Use the Express Service Code when contacting Dell for assistance. Express Service Code service may not be available in some countries.

**extended display mode** — A display setting that allows you to use a second monitor as an extension of your display. Also referred to as *dual display mode*.



**NOTE:** If your computer has two PC Card connectors, always install extended PC Cards in the top connector.

**extended PC Card** — A PC Card that extends beyond the edge of the PC Card slot when installed.



**NOTICE:** Always remove an extended PC Card before packing the computer or traveling. If something strikes the exposed end of the PC Card, the system board may be damaged.

---

## F

**Fahrenheit** — A temperature measurement system where 32° is the freezing point and 212° is the boiling point of water.

**FCC** — Federal Communications Commission — A U.S. agency responsible for enforcing communications-related regulations that state how much radiation computers and other electronic equipment can emit.

**floppy drive** — A disk drive that can read and write to floppy disks.

**folder** — A term used to describe space on a disk or drive where files are organized and grouped. Files in a folder can be viewed and ordered in various ways, such as alphabetically, by date, and by size.

**format** — The process that prepares a drive or disk for file storage. When a drive or disk is formatted, the existing information on it is lost.

**FSB** — front side bus — The data path and physical interface between the microprocessor and RAM.

**FTP** — file transfer protocol — A standard Internet protocol used to exchange files between computers connected to the Internet.

---

## G

**G** — gravity — A measurement of weight and force.

**GB** — gigabyte — A measurement of data storage that equals 1024 MB (1,073,741,824 bytes). When used to refer to hard drive storage, the term is often rounded to 1,000,000,000 bytes.

**GHz** — gigahertz — A measurement of frequency that equals one thousand million Hz, or one thousand MHz. The speeds for computer microprocessors, buses, and interfaces are often measured in GHz.

**graphics mode** — A video mode that can be defined as x horizontal pixels by y vertical pixels by z colors. Graphics modes can display an unlimited variety of shapes and fonts.

**GUI** — graphical user interface — Software that interacts with the user by means of menus, windows, and icons. Most programs that operate on the Windows operating systems are GUIs.

---

## H

**hard drive** — A drive that reads and writes data on a hard disk. The terms hard drive and hard disk are often used interchangeably.

**heat sink** — A metal plate on some microprocessors that helps dissipate heat.

**help file** — A file that contains descriptive or instructional information about a product. Some help files are associated with a particular program, such as *Help* in Microsoft Word. Other help files function as stand-alone reference sources. Help files typically have a filename extension of **.hlp** or **.chm**.

**hibernate mode** — A power management mode that saves everything in memory to a reserved space on the hard drive and then turns off the computer. When you restart the computer, the memory information that was saved to the hard drive is automatically restored.

**HTML** — hypertext markup language — A set of codes inserted into an Internet web page intended for display on an Internet browser.

**HTTP** — hypertext transfer protocol — A protocol for exchanging files between computers connected to the Internet.

**Hz** — hertz — A unit of frequency measurement that equals 1 cycle per second. Computers and electronic devices are often measured in kilohertz (kHz), megahertz (MHz), gigahertz (GHz), or terahertz (THz).

---

## I

**IC** — Industry Canada — The Canadian regulatory body responsible for regulating emissions from electronic equipment, much as the FCC does in the United States.

**IC** — integrated circuit — A semiconductor wafer, or chip, on which thousands or millions of tiny electronic components are fabricated for use in computer, audio, and video equipment.

**IDE** — integrated device electronics — An interface for mass storage devices in which the controller is integrated into the hard drive or CD drive.

**IEEE 1394** — Institute of Electrical and Electronics Engineers, Inc. — A high-performance serial bus used to connect IEEE 1394-compatible devices, such as digital cameras and DVD players, to the computer.

**infrared sensor** — A port that allows you to transfer data between the computer and infrared-compatible devices without using a cable connection.

**integrated** — Usually refers to components that are physically located on the computer's system board. Also referred to as *built-in*.

**I/O** — input/output — An operation or device that enters and extracts data from your computer. Keyboards and printers are I/O devices.

**I/O address** — An address in RAM that is associated with a specific device (such as a serial connector, parallel connector, or expansion slot) and allows the microprocessor to communicate with that device.

**IRQ** — interrupt request — An electronic pathway assigned to a specific device so that the device can communicate with the microprocessor. Each device connection must be assigned an IRQ. Although two devices can share the same IRQ assignment, you cannot operate both devices simultaneously.

**ISP** — Internet service provider — A company that allows you to access its host server to connect directly to the Internet, send and receive e-mail, and access websites. The ISP typically provides you with a software package, user name, and access phone numbers for a fee.

---

## K

**Kb** — kilobit — A unit of data that equals 1024 bits. A measurement of the capacity of memory integrated circuits.

**KB** — kilobyte — A unit of data that equals 1024 bytes but is often referred to as 1000 bytes.

**keyboard shortcut** — A command requiring you to press multiple keys at the same time. Also referred to as a *key combination*.

**kHz** — kilohertz — A measurement of frequency that equals 1000 Hz.

---

## L

**LAN** — local area network — A computer network covering a small area. A LAN usually is confined to a building or a few nearby buildings. A LAN can be connected to another LAN over any distance through telephone lines and radio waves to form a wide area network (WAN).

**LCD** — liquid crystal display — The technology used by portable computer and flat-panel displays.

**LED** — light-emitting diode — An electronic component that emits light to indicate the status of the computer.

**local bus** — A data bus that provides a fast throughput for devices to the microprocessor.

**LPT** — line print terminal — The designation for a parallel connection to a printer or other parallel device.

---

## M

**Mb** — megabit — A measurement of memory chip capacity that equals 1024 Kb.



**Mbps** — megabits per second — One million bits per second. This measurement is typically used for transmission speeds for networks and modems.

**MB** — megabyte — A measurement of data storage that equals 1,048,576 bytes. 1 MB equals 1024 KB. When used to refer to hard drive storage, the term is often rounded to 1,000,000 bytes.

**MB/sec** — megabytes per second — One million bytes per second. This measurement is typically used for data transfer ratings.

**memory** — A temporary data storage area inside your computer. Because the data in memory is not permanent, it is recommended that you frequently save your files while you are working on them, and always save your files before you shut down the computer. Your computer can contain several different forms of memory, such as RAM, ROM, and video memory. Frequently, the word memory is used as a synonym for RAM.

**memory address** — A specific location where data is temporarily stored in RAM.

**memory mapping** — The process by which the computer assigns memory addresses to physical locations at start-up. Devices and software can then identify information that the microprocessor can access.

**memory module** — A small circuit board containing memory chips, which connects to the system board.

**MHz** — megahertz — A measure of frequency that equals 1 million cycles per second. The speeds for computer microprocessors, buses, and interfaces are often measured in MHz.

**microprocessor** — A computer chip that interprets and executes program instructions. Sometimes the microprocessor is referred to as the processor or the CPU (central processing unit).

**modem** — A device that allows your computer to communicate with other computers over analog telephone lines. Three types of modems include: external, PC Card, and internal. You typically use your modem to connect to the Internet and exchange e-mail.

**module bay** — A bay that supports devices such as optical drives, a second battery, or a Dell TravelLite™ module.

**monitor** — The high-resolution TV-like device that displays computer output.

**mouse** — A pointing device that controls the movement of the cursor on your screen. Typically you roll the mouse over a hard, flat surface to move the pointer or cursor on your screen.

**ms** — millisecond — A measure of time that equals one thousandth of a second. Access times of storage devices are often measured in ms.

---

## N

**network adapter** — A chip that provides network capabilities. A computer may include a network adapter on its system board, or it may contain a PC Card with an adapter on it. A network adapter is also referred to as a *NIC* (network interface controller).

**NIC** — See *network adapter*.

**notification area** — The section of the Windows taskbar that contains icons for providing quick access to programs and computer functions, such as the clock, volume control, and print status. Also referred to as

*system tray.*

**ns** — nanosecond — A measure of time that equals one billionth of a second.

**NVRAM** — nonvolatile random access memory — A type of memory that stores data when the computer is turned off or loses its external power source. NVRAM is used for maintaining computer configuration information such as date, time, and other system setup options that you can set.

---

## O

**Optical Drive** — A drive that uses optical technology to read or write data from CDs, DVDs, or DVD+RWs. Example of optical drives include CD drives, DVD drives, CD-RW drives, and CD-RW/DVD combo drives.

---

## P

**parallel connector** — An I/O port often used to connect a parallel printer to your computer. Also referred to as an *LPT port*.

**partition** — A physical storage area on a hard drive that is assigned to one or more logical storage areas known as logical drives. Each partition can contain multiple logical drives.

**PC Card** — A removable I/O card adhering to the PCMCIA standard. Modems and network adapters are common types of PC Cards.

**PCI** — peripheral component interconnect — PCI is a local bus that supports 32-and 64-bit data paths, providing a high-speed data path between the microprocessor and devices such as video, drives, and networks.

**PCMCIA** — Personal Computer Memory Card International Association — The organization that establishes standards for PC Cards.

**PIN** — personal identification number — A sequence of numerals and/or letters used to restrict unauthorized access to computer networks and other secure systems.

**PIO** — programmed input/output — A method of transferring data between two devices through the microprocessor as part of the data path.

**pixel** — A single point on a display screen. Pixels are arranged in rows and columns to create an image. A video resolution, such as 800 x 600, is expressed as the number of pixels across by the number of pixels up and down.

**Plug-and-Play** — The ability of the computer to automatically configure devices. Plug and Play provides automatic installation, configuration, and compatibility with existing hardware if the BIOS, operating system, and all devices are Plug and Play compliant.

**POST** — power-on self-test — Diagnostics programs, loaded automatically by the BIOS, that perform basic tests on the major computer components, such as memory, hard drives, and video. If no problems are detected during POST, the computer continues the start-up.

**program** — Any software that processes data for you, including spreadsheet, word processor, database, and

game packages. Programs require an operating system to run.

**PS/2** — personal system/2 — A type of connector for attaching a PS/2-compatible keyboard, mouse, or keypad.

**PXE** — pre-boot execution environment — A WfM (Wired for Management) standard that allows networked computers that do not have an operating system to be configured and started remotely.

---

## R

**RAID** — redundant array of independent disks — A system of two or more drives working together for performance and fault tolerance. RAID drives are typically used on servers and high-end PCs.

The three most common RAID levels are 0, 3, and 5:

- Level 0: Provides data striping but no redundancy. Level 0 improves performance but does not provide fault tolerance.
- Level 3: Same as Level 0, but also reserves one dedicated drive for error correction data, providing good performance and some level of fault tolerance.
- Level 5: Provides data striping at the byte level and also stripe error correction information, resulting in excellent performance and good fault tolerance.

**RAM** — random-access memory — The primary temporary storage area for program instructions and data. Any information stored in RAM is lost when you shut down your computer.

**readme file** — A text file included with a software package or hardware product. Typically, readme files provide installation information and describe new product enhancements or corrections that have not yet been documented.

**read-Only** — Data and/or files you can view but cannot edit or delete. A file can have read-only status if:

- It resides on a physically write-protected floppy disk, CD, or DVD.
- It is located on a network in a directory and the system administrator has assigned rights only to specific individuals.

**refresh rate** — The frequency, measured in Hz, at which your screen's horizontal lines are recharged (sometimes also referred to as its *vertical frequency*). The higher the refresh rate, the less video flicker can be seen by the human eye.

**resolution** — The sharpness and clarity of an image produced by a printer or displayed on a monitor. The higher the resolution, the sharper the image.

**RFI** — radio frequency interference — Interference that is generated at typical radio frequencies, in the range of 10 kHz to 100,000 MHz. Radio frequencies are at the lower end of the electromagnetic frequency spectrum and are more likely to have interference than the higher frequency radiations, such as infrared and light.

**ROM** — read-only memory — Memory that stores data and programs that cannot be deleted or written to by the computer. ROM, unlike RAM, retains its contents after you shut down your computer. Some programs essential to the operation of your computer reside in ROM.

**RPM** — revolutions per minute — The number of rotations that occur per minute. Hard drive speed is often measured in rpm.

**RTC** — real time clock — Battery-powered clock on the system board that keeps the date and time after you

shut down the computer.

**RTCRTS** — real-time clock reset — A jumper on the system board of some computers that can often be used for troubleshooting problems.

---

## S

**ScanDisk** — A Microsoft utility that checks files, folders, and the hard disk's surface for errors. ScanDisk often runs when you restart the computer after it has stopped responding.

**SDRAM** — synchronous dynamic random-access memory — A type of DRAM that is synchronized with the optimal clock speed of the microprocessor.

**serial connector** — An I/O port often used to connect devices such as a handheld digital device or digital camera to your computer.

**Service Tag** — A bar code label on your computer that identifies your computer when you access Dell Support at **support.dell.com** or when you call Dell for customer service or technical support.

**setup program** — A program that is used to install and configure hardware and software. The **setup.exe** or **install.exe** program comes with most Windows software packages. Setup program differs from system setup program.

**shortcut** — An icon that provides quick access to frequently used programs, files, folders, and drives. When you place a shortcut on your Windows desktop and double-click the icon, you can open its corresponding folder or file without having to find it first. Shortcut icons do not change the location of files. If you delete a shortcut, the original file is not affected. Also, you can rename a shortcut icon.

**shutdown** — The process of closing windows and exiting programs, exiting the operating system, and turning off your computer. You can lose data if you turn off your computer before completing a shutdown.

**smart card** — A card that is embedded with a microprocessor and a memory chip. Smart cards can be used to authenticate a user on computers equipped for smart cards.

**software** — Anything that can be stored electronically, such as computer files or programs.

**S/PDIF** — Sony/Philips Digital Interface — An audio transfer file format that allows the transfer of audio from one file to another without converting it to and from an analog format, which could degrade the quality of the file.

**standby mode** — A power management mode that shuts down all unnecessary computer operations to save energy.

**surge protectors** — Prevent voltage spikes, such as those that may occur during an electrical storm, from entering the computer through the electrical outlet. Surge protectors do not protect against lightning strikes or against brownouts, which occur when the voltage drops more than 20 percent below the normal AC-line voltage level.

Network connections cannot be protected by surge protectors. Always disconnect the network cable from the network connector during electrical storms.

**SVGA** — super-video graphics array — A video standard for video cards and controllers. Typical SVGA resolutions are 800 x 600 and 1024 x 768.

The number of colors and resolution that a program displays depends on the capabilities of the monitor, the video controller and its drivers, and the amount of video memory installed in the computer.

**S-video TV-out** — A connector used to attach a TV or digital audio device to the computer.

**SXGA** — super-extended graphics array — A video standard for video cards and controllers that supports resolutions up to 1280 x 1024.

**SXGA+** — super-extended graphics array plus — A video standard for video cards and controllers that supports resolutions up to 1400 x 1050.

**system board** — The main circuit board in your computer. Also known as the *motherboard*.

**system setup program** — A utility that serves as an interface between the computer hardware and the operating system. System setup allows you to configure user-selectable options in the BIOS, such as date and time or system password. Unless you understand what effect the settings have on the computer, do not change the settings for this program.

**system tray** — See *notification area*.

---

## T

**TAPI** — telephony application programming interface — Enables Windows programs to operate with a wide variety of telephony devices, including voice, data, fax, and video.

**text editor** — A program used to create and edit files that contain only text; for example, Windows Notepad uses a text editor. Text editors do not usually provide word wrap or formatting functionality (the option to underline, change fonts, and so on).

**travel module** — A plastic device designed to fit inside the module bay of a portable computer to reduce the weight of the computer.

---

## U

**UPS** — uninterruptible power supply — A backup power source used when the electrical power fails or drops to an unacceptable voltage level. A UPS keeps a computer running for a limited amount of time when there is no electrical power. UPS systems typically provide surge suppression and may also provide voltage regulation. Small UPS systems provide battery power for a few minutes to enable you to shut down your computer.

**USB** — universal serial bus — A hardware interface for a low-speed device such as a USB-compatible keyboard, mouse, joystick, scanner, set of speakers, printer, broadband devices (DSL and cable modems), imaging devices, or storage devices. Devices are plugged directly in to a 4-pin socket on your computer or in to a multi-port hub that plugs in to your computer. USB devices can be connected and disconnected while the computer is turned on, and they can also be daisy-chained together.

**UTP** — unshielded twisted pair — Describes a type of cable used in most telephone networks and some computer networks. Pairs of unshielded wires are twisted to protect against electromagnetic interference, rather than relying on a metal sheath around each pair of wires to protect against interference.

**UXGA** — ultra extended graphics array — A video standard for video cards and controllers that supports

resolutions up to 1600 x 1200.

---

## V

**video controller** — The circuitry on a video card or on the system board (in computers with an integrated video controller) that provides the video capabilities—in combination with the monitor—for your computer.

**video memory** — Memory that consists of memory chips dedicated to video functions. Video memory is usually faster than system memory. The amount of video memory installed primarily influences the number of colors that a program can display.

**video mode** — A mode that describes how text and graphics are displayed on a monitor. Graphics-based software, such as Windows operating systems, displays in video modes that can be defined as  $x$  horizontal pixels by  $y$  vertical pixels by  $z$  colors. Character-based software, such as text editors, displays in video modes that can be defined as  $x$  columns by  $y$  rows of characters.

**video resolution** — See *resolution*.

**virus** — A program that is designed to inconvenience you or to destroy data stored on your computer. A virus program moves from one computer to another through an infected disk, software downloaded from the Internet, or e-mail attachments. When an infected program starts, its embedded virus also starts.

A common type of virus is a boot virus, which is stored in the boot sectors of a floppy disk. If the floppy disk is left in the drive when the computer is shut down and then turned on, the computer is infected when it reads the boot sectors of the floppy disk expecting to find the operating system. If the computer is infected, the boot virus may replicate itself onto all the floppy disks that are read or written in that computer until the virus is eradicated.

**V** — volt — The measurement of electric potential or electromotive force. One V appears across a resistance of 1 ohm when a current of 1 ampere flows through that resistance.

---

## W

**W** — watt — The measurement of electrical power. One W is 1 ampere of current flowing at 1 volt.

**WHr** — watt-hour — A unit of measure commonly used to indicate the approximate capacity of a battery. For example, a 66-WHr battery can supply 66 W of power for 1 hour or 33 W for 2 hours.

**wallpaper** — The background pattern or picture on the Windows desktop. Change your wallpaper through the Windows Control Panel. You can also scan in your favorite picture and make it wallpaper.

**write-protected** — Files or media that cannot be changed. Use write-protection when you want to protect data from being changed or destroyed. To write-protect a 3.5-inch floppy disk, slide its write-protect tab to the open position.

---

## X

**XGA** — extended graphics array — A video standard for video cards and controllers that supports resolutions up to 1024 x 768.

---

## Z

**ZIF** — zero insertion force — A type of socket or connector that allows a computer chip to be installed or removed with no stress applied to either the chip or its socket.

**Zip** — A popular data compression format. Files that have been compressed with the Zip format are called Zip files and usually have a filename extension of **.zip**. A special kind of zipped file is a self-extracting file, which has a filename extension of **.exe**. You can unzip a self-extracting file by double-clicking it.

**Zip drive** — A high-capacity floppy drive developed by Iomega Corporation that uses 3.5-inch removable disks called Zip disks. Zip disks are slightly larger than regular floppy disks, about twice as thick, and hold up to 100 MB of data.

# Appendix

- [Macrovision Product Notice](#)
  - [Ergonomic Computing Habits](#)
  - [Regulatory Notices](#)
  - [Warranty and Return Policy](#)
- 

## Macrovision Product Notice

This product incorporates copyright protection technology that is protected by method claims of certain U.S. patents and other intellectual property rights owned by Macrovision Corporation and other rights owners. Use of this copyright protection technology must be authorized by Macrovision Corporation, and is intended for home and other limited viewing uses only unless otherwise authorized by Macrovision Corporation. Reverse engineering or disassembly is prohibited.

---

## Ergonomic Computing Habits



**CAUTION: Improper or prolonged keyboard use may result in injury.**



**CAUTION: Viewing the display or external monitor screen for extended periods of time may result in eye strain.**

For comfort and efficiency, observe the following ergonomic guidelines when setting up and using your computer workstation:

- Position your computer directly in front of you as you work.
- Adjust the tilt of the computer's display, its contrast and/or brightness settings, and the lighting around you (such as overhead lights, desk lamps, and the curtains or blinds on nearby windows) to minimize reflections and glare on the display.
- When using an external monitor with your computer, set the monitor at a comfortable viewing distance (usually 450 to 610 millimeters [18 to 24 inches] from your eyes). Make sure the monitor screen is at eye level or slightly lower when you are sitting in front of the monitor.
- Use a chair that provides good lower-back support.
- Keep your forearms horizontal with your wrists in a neutral, comfortable position while using the keyboard, touch pad, track stick, or external mouse.
- Always use the palm rest with the keyboard, touch pad, or track stick. Leave space to rest your hands when using an external mouse.
- Let your upper arms hang naturally at your sides.



- Ensure that your feet are resting flat on the floor.
- When sitting, make sure the weight of your legs is on your feet and not on the front of your chair seat. Adjust your chair's height or use a footrest, if necessary, to maintain proper posture.
- Vary your work activities. Try to organize your work so that you do not have to type for extended periods of time. When you stop typing, try to do things that use both hands.

For more information about ergonomic computing habits, see the BSR/HFES 100 standard, which can be purchased on the Human Factors and Ergonomics Society (HFES) website at:  
**[www.hfes.org/publications/HFES100.html](http://www.hfes.org/publications/HFES100.html)**

#### References:

1. American National Standards Institute. *ANSI/HFES 100: American National Standards for Human Factors Engineering of Visual Display Terminal Workstations*. Santa Monica, CA: Human Factors Society, Inc., 1988.
2. Human Factors and Ergonomics Society. *BSR/HFES 100 Draft standard for trial use: Human Factors Engineering of Computer Workstations*. Santa Monica, CA: Human Factors and Ergonomics Society, 2002.
3. International Organization for Standardization (ISO). *ISO 9241 Ergonomics requirements for office work with visual display terminals (VDTs)*. Geneva, Switzerland: International Organization for Standardization, 1992.

---

## Regulatory Notices

Electromagnetic Interference (EMI) is any signal or emission, radiated in free space or conducted along power or signal leads, that endangers the functioning of a radio navigation or other safety service or seriously degrades, obstructs, or repeatedly interrupts a licensed radio communications service. Radio communications services include but are not limited to AM/FM commercial broadcast, television, cellular services, radar, air-traffic control, pager, and Personal Communication Services (PCS). These licensed services, along with unintentional radiators such as digital devices, including computers, contribute to the electromagnetic environment.

Electromagnetic Compatibility (EMC) is the ability of items of electronic equipment to function properly together in the electronic environment. While this computer has been designed and determined to be compliant with regulatory agency limits for EMI, there is no guarantee that interference will not occur in a particular installation. If this equipment does cause interference with radio communications services, which can be determined by turning the equipment off and on, you are encouraged to try to correct the interference by one or more of the following measures:

- Reorient the receiving antenna.
- Relocate the computer with respect to the receiver.
- Move the computer away from the receiver.
- Plug the computer into a different outlet so that the computer and the receiver are on different branch circuits.

If necessary, consult a Dell Technical Support representative or an experienced radio/television technician for additional suggestions.

Dell™ computers are designed, tested, and classified for their intended electromagnetic environment. These electromagnetic environment classifications generally refer to the following harmonized definitions:

- Class A is typically for business or industrial environments.
- Class B is typically for residential environments.

Information Technology Equipment (ITE), including devices, expansion cards, printers, input/output (I/O) devices, monitors, and so on, that are integrated into or connected to the computer should match the electromagnetic environment classification of the computer.

**A Notice About Shielded Signal Cables: Use only shielded cables for connecting devices to any Dell device to reduce the possibility of interference with radio communications services. Using shielded cables ensures that you maintain the appropriate EMC classification for the intended environment. For parallel printers, a cable is available from Dell. If you prefer, you can order a cable from Dell on the World Wide Web at [accessories.us.dell.com/sna/category.asp?category\\_id=4117](http://accessories.us.dell.com/sna/category.asp?category_id=4117).**

Most Dell computers are classified for Class B environments. However, the inclusion of certain options can change the rating of some configurations to Class A. To determine the electromagnetic classification for your computer or device, see the following sections specific for each regulatory agency. Each section provides country-specific EMC/EMI or product safety information.

## FCC Notices (U.S. Only)

Most Dell computers are classified by the Federal Communications Commission (FCC) as Class B digital devices. To determine which classification applies to your computer, examine all FCC registration labels located on the bottom, side, or back panel of your computer, on card-mounting brackets, and on the cards themselves. If any one of the labels carries a Class A rating, your entire computer is considered to be a Class A digital device. If *all* labels carry an FCC Class B rating as distinguished by either an FCC ID number or the FCC logo, (FC), your computer is considered to be a Class B digital device.

Once you have determined your computer's FCC classification, read the appropriate FCC notice. Note that FCC regulations provide that changes or modifications not expressly approved by Dell could void your authority to operate this equipment.

This device complies with Part 15 of the FCC Rules. Operation is subject to the following two conditions:

- This device may not cause harmful interference.
- This device must accept any interference received, including interference that may cause undesired operation.

## Class A

This equipment has been tested and found to comply with the limits for a Class A digital device pursuant to Part 15 of the FCC Rules. These limits are designed to provide reasonable protection against harmful interference when the equipment is operated in a commercial environment. This equipment generates, uses, and can radiate radio frequency energy and, if not installed and used in accordance with the manufacturer's instruction manual, may cause harmful interference with radio communications. Operation of this equipment in a residential area is likely to cause harmful interference, in which case you will be required to correct the interference at your own expense.

## Class B

This equipment has been tested and found to comply with the limits for a Class B digital device pursuant to Part 15 of the FCC Rules. These limits are designed to provide reasonable protection against harmful interference in a residential installation. This equipment generates, uses, and can radiate radio frequency energy and, if not installed and used in accordance with the manufacturer's instruction manual, may cause interference with radio communications. However, there is no guarantee that interference will not occur in a particular installation. If this equipment does cause harmful interference to radio or television reception, which

can be determined by turning the equipment off and on, you are encouraged to try to correct the interference by one or more of the following measures:

- Reorient or relocate the receiving antenna.
- Increase the separation between the equipment and the receiver.
- Connect the equipment into an outlet on a circuit different from that to which the receiver is connected.
- Consult the dealer or an experienced radio/television technician for help.

## **FCC Identification Information**

The following information is provided on the device or devices covered in this document in compliance with FCC regulations:

- Model number:
- Company name:

Dell Inc.  
One Dell Way  
Round Rock, Texas 78682 USA  
512-338-4400

## **Modem Regulatory Information**

This equipment complies with Part 68 of the FCC Rules. On the bottom of your computer is a label that contains, among other information, the FCC registration number and ringer equivalence number (REN) for your equipment. If requested, you must provide this information to the telephone company.

The REN is used to determine the quantity of devices that may be connected to the telephone line. Excessive RENs on the telephone line may result in the devices not ringing in response to an incoming call. In most areas, the sum of all the RENs on your telephone line should be less than five to ensure proper service from the telephone company. To be certain of the number of devices that you may connect to a line, as determined by the total RENs, contact your local telephone company.

The registration jack Universal Service Order Code (USOC) used by this equipment is RJ-11C. An FCC compliant telephone cord and modular plug is provided with this equipment. This equipment is designed to be connected to the telephone network or premises wiring using a compatible modular jack that is Part 68 compliant.

This equipment cannot be used on public coin-phone service provided by the telephone company. Connection to party line service is subject to state tariffs.

There are no user serviceable parts on the modem contained in your computer.

If your telephone equipment causes harm to the telephone network, the telephone company will notify you in advance that service may be temporarily discontinued. If advance notice is not practical, the telephone company will notify you as soon as possible. Also, you will be advised of your right to file a complaint with the FCC if you believe it is necessary.

The telephone company may make changes in its facilities, equipment, operations, or procedures that could affect the operation of this equipment. If this happens, the telephone company will provide advance notice in order for you to make necessary modifications to maintain uninterrupted service.

If you experience trouble with this telephone equipment, see "Getting Help" in your computer's

troubleshooting documentation or, for some computers, the section titled "Contacting Dell" in your computer's online guide to find the appropriate telephone number for obtaining customer assistance. If the equipment is causing harm to the telephone network, the telephone company may request that you disconnect the equipment until the problem is resolved.

## Fax Branding

The Telephone Consumer Protection Act of 1991 makes it unlawful for any person to use a computer or other electronic device, including fax machines, to send any message unless such message clearly contains in a margin at the top or bottom of each transmitted page or on the first page of the transmission, the date and time it is sent, identification of the business, other entity, or individual sending the message, and the telephone number of the sending machine or such business, other entity, or individual. The telephone number provided may not be a 900 number or any other number for which charges exceed local or long-distance transmission charges.

## IC Notice (Canada Only)

Most Dell computers (and other Dell digital apparatus) are classified by the Industry Canada (IC) Interference-Causing Equipment Standard #3 (ICES-003) as Class B digital devices. To determine which classification (Class A or B) applies to your computer (or other Dell digital apparatus), examine all registration labels located on the bottom, side, or the back panel of your computer (or other digital apparatus). A statement in the form of "IC Class A ICES-003" or "IC Class B ICES-003" will be located on one of these labels. Note that Industry Canada regulations provide that changes or modifications not expressly approved by Dell could void your authority to operate this equipment.

This Class B (or Class A, if so indicated on the registration label) digital apparatus meets the requirements of the Canadian Interference-Causing Equipment Regulations.

Cet appareil numérique de la Classe B (ou Classe A, si ainsi indiqué sur l'étiquette

## Modem Regulatory Information

The IC label identifies certified equipment. This certification means that the equipment meets telecommunications network protective, operational, and safety requirements as prescribed in the appropriate Terminal Equipment Technical Requirements document(s). The IC label does not guarantee that the equipment will operate to the user's satisfaction.

Before installing this equipment, users should ensure that it is permissible to be connected to the facilities of the local telecommunications company. The equipment must also be installed using an acceptable method of connection. The customer should be aware that compliance with the above conditions may not prevent degradation of service in some situations.

Repairs to certified equipment should be coordinated by a representative designated by the supplier. Any repairs or alteration made by a user to this equipment, or equipment malfunctions, may give the telephone communications company cause to request the user to disconnect the equipment.

Users should ensure for their own protection, that the electrical ground connections of the power utility, telephone lines, and internal metallic water-pipe system, if present, are connected together. This precaution may be particularly important in rural areas.



**NOTICE:** Users should not attempt to make such connections themselves. Contact the appropriate electric inspection authority, or electrician, as appropriate.



**NOTE:** The REN assigned to each terminal device provides an indication of the maximum number of

terminals allowed to be connected to a telephone interface. The termination on an interface may consist of any combination of devices subject only to the requirement that the sum of the RENs of all the devices does not exceed the number five.

The REN for the internal modem as stated on the IC regulatory label located on the bottom of the computer is 0.6 B.

The following information is provided in compliance with IC regulations:

Dell Inc.  
One Dell Way  
Round Rock, TX 78682 USA  
512-338-4400

## CE Notice (European Union)

Marking by the symbol  indicates compliance of this Dell computer to the EMC Directive and the Low Voltage Directive of the European Union. Such marking is indicative that this Dell system meets the following technical standards:

- EN 55022 — "Information Technology Equipment — Radio Disturbance Characteristics — Limits and Methods of Measurement."
- EN 55024 — "Information Technology Equipment - Immunity Characteristics - Limits and Methods of Measurement."
- EN 61000-3-2 — "Electromagnetic Compatibility (EMC) - Part 3: Limits - Section 2: Limits for Harmonic Current Emissions (Equipment Input Current Up to and Including 16 A Per Phase)."
- EN 61000-3-3 — "Electromagnetic Compatibility (EMC) - Part 3: Limits - Section 3: Limitation of Voltage Fluctuations and Flicker in Low-Voltage Supply Systems for Equipment With Rated Current Up to and Including 16 A."
- EN 60950 — "Safety of Information Technology Equipment."

 **NOTE:** EN 55022 emissions requirements provide for two classifications:

- Class A is for typical commercial areas.
- Class B is for typical domestic areas.

**RF INTERFERENCE WARNING: This is a Class A product. In a domestic environment this product may cause radio frequency (RF) interference, in which case the user may be required to take adequate measures.**

This Dell device is classified for use in a typical Class B domestic environment.

A "Declaration of Conformity" in accordance with the preceding directives and standards has been made and is on file at Dell Inc. Products Europe BV, Limerick, Ireland.

## CE Mark Notice

This equipment complies with the essential requirements of the European Union Directive 1999/5/EC.

Cet équipement est conforme aux principales caractéristiques définies dans la Directive européenne RTTE 1999/5/CE.

Die Geräte erfüllen die grundlegenden Anforderungen der RTTE-Richtlinie (1999/5/EG).

Questa apparecchiatura é conforme ai requisiti essenziali della Direttiva Europea R&TTE 1999/5/CE.

Este equipo cumple los requisitos principales de la Directiva 1999/5/CE de la UE, "Equipos de Terminales de Radio y Telecomunicaciones".

Este equipamento cumpre os requisitos essenciais da Directiva 1999/5/CE do Parlamento Europeu e do Conselho (Directiva RTT).

Ο εξοπλισμός αυτός πληροί τις βασικές απαιτήσεις της κοινοτικής οδηγίας EU R&TTE 1999/5/EK.

Deze apparatuur voldoet aan de noodzakelijke vereisten van EU-richtlijn betreffende radioapparatuur en telecommunicatie-apparatuur 1999/5/EG.

Dette udstyr opfylder de Væsentlige krav i EU's direktiv 1999/5/EC om Radio- og teleterminaludstyr.

Dette utstyret er i overensstemmelse med hovedkravene i R&TTE-direktivet (1999/5/EC) fra EU.

Utrustningen uppfyller kraven för EU-direktivet 1999/5/EC om ansluten teleutrustning och ömsesidigt erkännande av utrustningens överensstämmelse (R&TTE).

Tämä laite vastaa EU:n radio- ja telepäätelaitedirektiivin (EU R&TTE Directive 1999/5/EC) vaatimuksia.

## New Zealand Telecom Warnings

### General

"The grant of a Telepermit for any item of terminal equipment indicates only that Telecom has accepted that the item complies with minimum conditions for connection to its network. It indicates no endorsement of the product by Telecom, nor does it provide any sort of warranty. Above all, it provides no assurance that any item will work correctly in all respects with another item of Telepermitted equipment of a different make or model, nor does it imply that any product is compatible with all of Telecom's network services."

"This equipment does not fully meet Telecom impedance requirements. Performance limitations may occur when used in conjunction with some parts of the network. Telecom will accept no responsibility should difficulties arise in such circumstances."

"This equipment shall not be set up to make automatic calls to the Telecom `111' Emergence Service."

"If a charge for local calls is unacceptable, the `Dial' button should NOT be used for local calls. Only the 7-digits of the local number should be dialed from your telephone. DO NOT dial the area code digit or the `0' prefix."

"This equipment may not provide for the effective hand-over of a call to another device connected to the same line."

### Important Notice

"Under power failure conditions, this telephone may not operate. Please ensure that a separate telephone, not dependent on local power, is available for emergency use."

"Some parameters required for compliance with Telecom's Telepermit requirements are dependent on the equipment (PC) associated with this device. The associated equipment shall be set to operate within the following limits for compliance with Telecom's Specification:

1. There shall be no more than 10 call attempts to the same number within any 30-minute period for any single manual call initiation, and the equipment shall go on-hook for a period of not less than 30 seconds between the end of one attempt and the beginning of the next attempt.
2. Where automatic calls are made to different numbers, the equipment shall go on-line for a period of not less than 5 seconds between the end of one attempt and the beginning of the next attempt.
3. The equipment shall be set to ensure that calls are answered between 3 and 30 seconds of receipt of ringing."

"All persons using this device for recording telephone conversations shall comply with New Zealand law. This requires that at least one party to the conversation is to be aware that it is being recorded. In addition, the Principles enumerated in the Privacy Act of 1993 shall be complied with in respect to the nature of the personal information collected, the purpose for its collection, how it is used and what is disclosed to any other party."

## Simplified Chinese Class A Warning Notice (China Only)

On Class A systems, the following warning will appear near the regulatory label:

**Warning: This is a Class A product. In a domestic environment this product may cause radio interference, in which case the user may be required to take adequate measures.**

### 声明

此为A级产品，在生活环境中，该产品可能会造成无线电干扰。在这种情况下，可能需要用户对其干扰采取切实可行的措施。

## EN 55022 Compliance (Czech Republic Only)

This device belongs to Class B devices as described in EN 55022, unless it is specifically stated that it is a Class A device on the specification label. The following applies to devices in Class A of EN 55022 (radius of protection up to 30 meters). The user of the device is

Pokud není na typovém štítku počítače uvedeno, že spadá do třídy A podle EN 55022, spadá automaticky do třídy B podle EN 55022. Pro zařízení zařazená do třídy A (ochranné pásmo 30m) podle EN 55022 platí následující. Dojde-li k rušení telekomunikačních nebo jiných zařízení, je uživatel povinen provést taková opatření, aby rušení odstranil.

## VCCI Notice (Japan Only)

Most Dell computers are classified by the Voluntary Control Council for Interference (VCCI) as Class B information technology equipment (ITE). However, the inclusion of certain options can change the rating of some configurations to Class A. ITE, including devices, expansion cards, printers, input/output (I/O) devices, monitors, and so on, integrated into or connected to the computer should match the electromagnetic environment classification (Class A or B) of the computer.

To determine which classification applies to your computer, examine the regulatory labels/markings located on the bottom, side, or back panel of your computer. Once you have determined your computer's VCCI classification, read the appropriate VCCI notice (see "VCCI Class A ITE Regulatory Mark" or "VCCI Class B ITE Regulatory Mark").

## Class A ITE

この装置は、情報処理装置等電波障害自主規制協議会 (VCCI) の基準に基づくクラス A 情報技術装置です。この装置を家庭環境で使用すると電波妨害を引き起こすことがあります。この場合には使用者が適切な対策を講ずるよう要求されることがあります。

This is a Class A product based on the standard of the Voluntary Control Council for Interference (VCCI) for information technology equipment. If this equipment is used in a domestic environment, radio disturbance may arise. When such trouble occurs, the user may be required to take corrective actions.

### VCCI Class A ITE Regulatory Mark

If the regulatory label includes the following marking, your computer is a Class A product: 

### Class B ITE

この装置は、情報処理装置等電波障害自主規制協議会 (VCCI) の基準に基づくクラス B 情報技術装置です。この装置は家庭環境で使用することを目的としていますが、ラジオやテレビジョン受信機に近接して使用されると、受信障害を引き起こすことがあります。取扱説明書に従って正しい取り扱いをしてください。

This is a Class B product based on the standard of the Voluntary Control Council for Interference (VCCI) for information technology equipment. If this equipment is used near a radio or television receiver in a domestic environment, it may cause radio interference. Install and use the equipment according to the instruction manual.

### VCCI Class B ITE Regulatory Mark

If the regulatory label includes the following marking, your computer is a Class B product:



## MIC Notice (Republic of Korea Only)

To determine which classification (Class A or B) applies to your computer (or other Dell digital device), examine the Republic of Korean Ministry of Information and Communications (MIC) registration labels located on your computer (or other Dell digital device). The MIC label may be located separately from the other regulatory marking applied to your product. Line two of the label identifies the emissions class for the product—"A" for Class A products or "B" for Class B products.

 **NOTE:** MIC emissions requirements provide for two classifications:

- Class A devices are for business purposes.
- Class B devices are for nonbusiness purposes.

### Class A Device



기종별	사용자안내문
A급 기기 (업무용 정보통신기기)	이 기기는 업무용으로 전자파적합등록을 한 기기이오니 판매자 또는 사용자는 이 점을 주의하시기 바라며 만약 잘못 판매 또는 구입하였을 때에는 가정용으로 교환하시기 바랍니다.

Please note that this device has been approved for business purposes with regard to electromagnetic interference. If you find that this device is not suitable for your use, you may exchange it for a nonbusiness-purpose device.

### MIC Class A Regulatory Label

If the regulatory label includes the following marking, your computer is a Class A product:



1. 기기의 명칭(모델명):
2. 인증번호:(A)
3. 인증받은 자의 상호:
4. 제조년월일:
5. 제조자/제조국가:

### Class B Device

기종별	사용자안내문
B급 기기 (가정용 정보통신기기)	이 기기는 가정용으로 전자파적합등록을 한 기기로서 주거지역에서는 물론 모든 지역에서 사용할 수 있습니다.

Please note that this device has been approved for nonbusiness purposes and may be used in any environment, including residential areas.

### MIC Class B Regulatory Label

If the regulatory label includes the following marking, your computer is a Class B product:



- 명칭/모델명: 델컴퓨터/ PP10L (Latitude 505)  
 인증번호: Refer to Regulatory Label  
 인증받은자의 상호: 델 컴퓨터  
 제조년월일: Refer to Regulatory Label  
 제조자/제조국: Refer to Regulatory Label  
 for Country of Origin

### Polish Center for Testing and Certification Notice

The equipment should draw power from a socket with an attached protection circuit (a 3-prong socket). All equipment that works together (computer, monitor, printer, and so on) should have the same power supply source.

The phasing conductor of the room's electrical installation should have a reserve short-circuit protection device in the form of a fuse with a nominal value no larger than 16 amperes (A).

To completely switch off the equipment, the power supply cable must be removed from the power supply socket, which should be located near the equipment and easily accessible.

A protection mark "B" confirms that the equipment is in compliance with the protection usage requirements of standard PN-EN 55022.

#### Wymagania Polskiego Centrum Badań i Certyfikacji

Urządzenie powinno być zasilane z gniazda z przyłączonym obwodem ochronnym (gniazdo z kołkiem). Współpracujące ze sobą urządzenia (komputer, monitor, drukarka) powinny być zasilane z tego samego źródła.

Instalacja elektryczna pomieszczenia powinna zawierać w przewodzie fazowym rezerwową ochronę przed zwarciami, w postaci bezpiecznika o wartości znamionowej nie większej niż 16A (amperów).



W celu całkowitego wyłączenia urządzenia z sieci zasilania, należy wyjąć wtyczkę kabla zasilającego z gniazdka, które powinno znajdować się w pobliżu urządzenia i być łatwo dostępne. Znak bezpieczeństwa "B" potwierdza zgodność urządzenia z wymaganiami bezpieczeństwa użytkowania zawartymi w PN-EN 60950:2000 i PN-EN 55022:2000.

Jeżeli na tabliczce znamionowej umieszczono informacje, że urządzenie jest klasy A, to oznacza, że urządzenie w środowisku mieszkalnym może powodować zakłócenia radioelektryczne. W takich przypadkach można zadac od jego użytkownika zastosowania odpowiednich środków zaradczych.

#### Pozostałe instrukcje bezpieczeństwa

- Nie należy używać wtyczek adapterowych lub usuwać kołka obwodu ochronnego z wtyczki. Jeżeli konieczne jest użycie przedłużacza to należy użyć przedłużacza 3-żyłowego z prawidłowo połączonym przewodem ochronnym.
- System komputerowy należy zabezpieczyć przed nagłymi, chwilowymi wzrostami lub spadkami napięcia, używając eliminatora przepięć, urządzenia dopasowującego lub bezzakłócenowego źródła zasilania.
- Należy upewnić się, aby nic nie leżało na kablach systemu komputerowego, oraz aby kable nie były umieszczone w miejscu, gdzie można byłoby na nie nadeptywać lub potykać się o nie.
- Nie należy rozlewać napojów ani innych płynów na system komputerowy.
- Nie należy wpychać żadnych przedmiotów do otworów systemu komputerowego, gdyż może to spowodować pożar lub porażenie prądem, poprzez zwarcie elementów wewnętrznych.
- System komputerowy powinien znajdować się z dala od grzejników i źródeł ciepła. Ponadto, nie należy blokować otworów wentylacyjnych. Należy unikać kładzenia luźnych papierów pod komputer oraz umieszczania komputera w ciasnym miejscu bez możliwości cyrkulacji powietrza wokół niego.

## BSMI Notice (Taiwan Only)

If you find a  or  mark on the regulatory label on the bottom, side, or back panel of your computer, the following section is applicable:

## BSMI通告 (僅限於台灣)

大多數的 Dell 電腦系統被 BSMI (經濟部標準檢驗局) 劃分為乙類數位裝置。但是，使用某些選件會使有些組態的等級變成甲類。若要確定您的電腦系統適用等級，請檢查所有位於電腦底部或背面板、擴充卡安裝托架，以及擴充卡上的 BSMI 註冊標籤。如果其中有一甲類標籤，即表示您的系統為甲類數位裝置。如果只有 BSMI 的檢驗號碼標籤，則表示您的系統為乙類數位裝置。

一旦確定了系統的 BSMI 等級，請閱讀相關的 BSMI 通告。請注意，BSMI 通告規定凡是未經 Dell Computer Corporation 明確批准的擅自變更或修改，將導致您失去此設備的使用權。

此裝置符合 BSMI (經濟部標準檢驗局) 的規定，使用時須符合以下兩項條件：

- 此裝置不會產生有害干擾。
- 此裝置必須能接受所接收到的干擾，包括可能導致無法正常作業的干擾。

## 甲類

此設備經測試證明符合 BSMI (經濟部標準檢驗局) 之甲類數位裝置的限制規定。這些限制的目的是為了在商業環境中使用此設備時，能提供合理的保護以防止有害的干擾。此設備會產生、使用並散發射頻能量；如果未遵照製造廠商的指導手冊來安裝和使用，可能會干擾無線電通訊。請勿在住宅區使用此設備。

**警告使用者：**  
這是甲類的資訊產品，在居住的環境中使用時，可能會造成射頻干擾，  
在這種情況下，使用者會被要求採取某些適當的對策。

## 乙類

此設備經測試證明符合 BSMI (經濟部標準檢驗局) 之乙類數位裝置的限制規定。這些限制的目的是為了在住宅區安裝時，能防止有害的干擾，提供合理的保護。此設備會產生、使用並散發射頻能量；如果未遵照製造廠商的指導手冊來安裝和使用，可能會干擾無線電通訊。但是，這並不保證在個別的安装中不會產生干擾。您可以透過關閉和開啓此設備來判斷它是否會對廣播和電視收訊造成干擾；如果確實如此，我們建議您嘗試以下列一種或多種方法來排除干擾：

- 重新調整天線的接收方向或重新放置接收天線。
- 增加設備與接收器的距離。
- 將設備連接至不同的插座，使設備與接收器連接在不同的電路上。
- 請向經銷商或有經驗的無線電 / 電視技術人員查詢，以獲得幫助。

## NOM Information (Mexico Only)

The following information is provided on the device(s) described in this document in compliance with the requirements of the official Mexican standards (NOM):

Exporter:	Dell Inc. One Dell Way Round Rock, TX 78682
Importer:	Dell Computer de México, S.A. de C.V. Paseo de la Reforma 2620 - 11° Piso Col. Lomas Altas 11950 México, D.F.
Ship to:	Dell Computer de México, S.A. de C.V. al Cuidado de Kuehne & Nagel de México S. de R.L. Avenida Soles No. 55 Col. Peñon de los Baños 15520 México, D.F.
Model number:	PP10L
Supply voltage:	100-240 VAC

Frequency:	50–60 Hz
Current Consumption:	1.5 A
Output voltage:	19.5 VDC
Output current:	4.62 A

## ENERGY STAR® Compliance

Certain configurations of Dell computers comply with the requirements set forth by the Environmental Protection Agency (EPA) for energy-efficient computers. If the front panel of your computer bears the ENERGY STAR® Emblem, your original configuration complies with these requirements and all ENERGY STAR® power management features of the computer are enabled.

 **NOTE:** Any Dell computer bearing the ENERGY STAR® Emblem is certified to comply with EPA ENERGY STAR® requirements as configured when shipped by Dell. Any changes you make to this configuration (such as installing additional expansion cards or drives) may increase the computer's power consumption beyond the limits set by the EPA's ENERGY STAR® Computers program.

## ENERGY STAR® Emblem



The EPA's ENERGY STAR® Computers program is a joint effort between the EPA and computer manufacturers to reduce air pollution by promoting energy-efficient computer products. The EPA estimates that use of ENERGY STAR® computer products can save computer users up to two billion dollars annually in electricity costs. In turn, this reduction in electricity usage can reduce emissions of carbon dioxide, the gas primarily responsible for the greenhouse effect, and sulfur dioxide and nitrogen oxides, the primary causes of acid rain.

You can also help reduce electricity usage and its side effects by turning off your computer when it is not in use for extended periods of time, particularly at night and on weekends.

---

## Warranty and Return Policy

Dell Inc. ("Dell") manufactures its hardware products from parts and components that are new or equivalent to new in accordance with industry-standard practices. For information about the Dell™ warranty for your computer, see the *System Information Guide* or separate paper warranty document that shipped with your computer.

# Specifications

<b>Microprocessor</b>	
Microprocessor type	Intel® Centrino™ Mobile Technology or Intel® Pentium® M Processor
L1 cache	64 KB (internal); 32-KB instruction and 32-KB write-back data
L2 cache	1 MB
External bus frequency	400 MHz, source synchronous processor system bus

<b>System Information</b>	
Data bus width	64 bits
DRAM bus width	64 bits
Microprocessor address bus width	32 bits
Flash EPROM	1MB
PCI bus	32 bits

<b>PC Card</b>	
CardBus controller	PCI4510 CardBus controller
PC Card connector	supports one Type I or Type II card
Cards supported	3.3 V and 5 V
PC Card connector size	68 pins
Data width (maximum)	PCMCIA 16 bits CardBus 32 bits

<b>Memory</b>	
Minimum speed requirement	266 MHz
Memory module connector	two user-accessible DDR SDRAM connectors
Memory module capacities	128 MB, 256 MB, 512 MB, and 1024MB
Memory type	2.5V DDR SDRAM
Standard memory	128 MB
Maximum memory	2 GB

<b>Ports and Connectors</b>	
Serial	9-pin connector; 16550C-compatible,

	16-byte buffer connector
Parallel	25-hole connector; unidirectional, bidirectional, or ECP
Video	15-hole connector
Audio	microphone miniconnector, stereo headphones/speakers miniconnector
USB	two 4-pin USB 2.0-compliant connectors
Infrared sensor	sensor compatible with IrDA Standard 1.1 (Fast IR) and IrDA Standard 1.0 (Slow IR)
S-video TV-out	7-pin mini-DIN connector (optional S-video to composite video adapter cable)
Mini PCI	Type IIIA Mini PCI card slot
Modem	RJ-11 port
Network adapter	RJ-45 port
IEEE 1394	4-pin serial connector

<b>Communications</b>	
Modem:	
Type	v.92 56K MDC
Controller	softmodem
Interface	internal AC'97 bus
Network adapter	10/100 Ethernet LAN on system board
Wireless	internal Mini PCI Wi-Fi wireless support; Bluetooth™ (optional, available at point of sale only)

<b>Video</b>	
Video type	Intel UMA Integrated
Video controller	Intel 855GME Integrated chip set
Video memory	1 MB with Intel DVMT up to 32 MB (with 128 MB of system memory) or 64 MB (with 256 MB or more of system memory)
LCD interface	LVDS

<b>Audio</b>	
Audio type	compatible with Soundblaster and Microsoft® Windows® Sound

	System
Audio controller	Intel AC'97
Stereo conversion	20-bit (stereo digital-to-analog), 18-bit (stereo analog-to-digital)
Interfaces:	
Internal	AC'97
External	microphone miniconnector, stereo headphones/speakers miniconnector
Speaker	two 4-ohm speakers
Internal speaker amplifier	2-W channel into 4 ohms
Volume controls	keyboard shortcuts or program menus

<b>Display</b>	
Type (active-matrix TFT)	XGA
Dimensions:	
Height	228.1 mm (9 inches)
Width	304.1 mm (12 inches)
Diagonal	380.1 mm (15 inches)
Maximum resolutions	1024 x 768 at 16.8 million colors
Response time (typical)	25-ms rise (maximum), 35-ms fall (maximum)
Refresh rate	60 Hz
Operating angle	0° (closed) to 180°
Viewing angles:	
Horizontal	±60°
Vertical	±45°
Pixel pitch	0.2172 x 0.2172 mm
Power Consumption:	
Panel with backlight (typical)	4.6 W
Controls	brightness can be controlled through keyboard shortcuts

<b>Keyboard</b>	
Number of keys	87 (U.S. and Canada); 88 (Europe); 91 (Japan)
Key travel	2.7 mm ± 0.3 mm (0.11 inch ± 0.016 inch)
Key spacing	19.05 mm ± 0.3 mm (0.75 inch ±

	0.012 inch)
Layout	QWERTY/AZERTY/Kanji

<b>Touch Pad</b>	
X/Y position resolution (graphics table mode)	240 cpi
Size:	
Width	64.88-mm (2.55-inch) sensor-active area
Height	48.88-mm (1.92-inch) rectangle

<b>Battery</b>	
Type	6-cell "smart" lithium ion (48 WHr) 4-cell "smart" lithium ion (32 WHr)
Dimensions:	
Depth	77.5 mm (3.05 inches)
Height	19.5 mm (0.76 inch)
Width	123.4 mm (4.86 inches)
Weight	0.32 kg (0.7 lb) (6-cell battery) 0.23 kg (0.52 lb) (4-cell battery)
Voltage	11.1 VDC (6-cell battery) 14.8 VDC (4-cell battery)
Charge time with computer off (approximate)	1 hour for 80 percent charge
Operating time	approximately 3 to 4 hours (6-cell battery); approximately 2 to 2.5 hours (4-cell battery); can be significantly reduced under certain <a href="#">power-intensive conditions</a>
Life span (approximate)	300 discharge/charge cycles
Temperature range:	
Operating	0° to 35°C (32° to 95°F)
Storage	-20° to 65°C (-4° to 149°F)

<b>AC Adapter</b>	
Input voltage	90-264 VAC
Input current (maximum)	1.7 A
Input frequency	47-63 Hz
Output current	3.34A (65 W) 4.62A (90 W)
Output power	65 W or 90 W



Rated output voltage	19.5 VDC
Dimensions:	
Height	28.2mm (1.11 inches) (65 W) 34.2mm (1.35 inches) (90 W)
Width	57.9mm (2.28 inches) (65 W) 60.8mm (2.39 inches) (90 W)
Depth	137.2mm (5.40 inches) (65 W) 153.4mm (6.04 inches) (90 W)
Weight (with cables)	0.4 kg (1 lb) (90 W) 0.3 kg (.69 lb) (65 W)
Temperature range:	
Operating	0° to 35°C (32° to 95°F)
Storage	-40° to 65°C (-40° to 149°F)

<b>Computer Dimensions and Weight</b>	
Height	35.5 mm (1.40 inches)
Width	338.4 mm (13.32 inches)
Depth	273 mm (10.75 inches)
Weight:	
With travel module and standard battery	2.49 kg (5.49 lb)
With CD drive and standard battery	2.70 kg (5.94 lb)

<b>Computer Environmental</b>	
Temperature range:	
Operating	0° to 35°C (32° to 95°F)
Storage	-40° to 65°C (-40° to 149°F)
Relative humidity (maximum):	
Operating	10% to 90% (noncondensing)
Storage	5% to 95% (noncondensing)
Maximum vibration (using a random-vibration spectrum that simulates user environment):	
Operating	0.66 GRMS
Storage	1.30 GRMS
Maximum shock (measured with hard drive in head-parked position and a 2-ms half-sine pulse):	
Operating	122 G
Storage	163 G

Altitude (maximum):	
Operating	-15.2 to 3048 m (-50 to 10,000 ft)
Storage	-15.2 to 10,668 m (-50 to 35,000 ft)

# Specifications

<b>Microprocessor</b>	
Microprocessor type	Intel® Centrino™ Mobile Technology or Intel® Pentium® M Processor
L1 cache	64 KB (internal); 32-KB instruction and 32-KB write-back data
L2 cache	1 MB
External bus frequency	400 MHz, source synchronous processor system bus

<b>System Information</b>	
Data bus width	64 bits
DRAM bus width	64 bits
Microprocessor address bus width	32 bits
Flash EPROM	1MB
PCI bus	32 bits

<b>PC Card</b>	
CardBus controller	PCI4510 CardBus controller
PC Card connector	supports one Type I or Type II card
Cards supported	3.3 V and 5 V
PC Card connector size	68 pins
Data width (maximum)	PCMCIA 16 bits CardBus 32 bits

<b>Memory</b>	
Minimum speed requirement	266 MHz
Memory module connector	two user-accessible DDR SDRAM connectors
Memory module capacities	128 MB, 256 MB, 512 MB, and 1024MB
Memory type	2.5V DDR SDRAM
Standard memory	128 MB
Maximum memory	2 GB

<b>Ports and Connectors</b>	
Serial	9-pin connector; 16550C-compatible,

	16-byte buffer connector
Parallel	25-hole connector; unidirectional, bidirectional, or ECP
Video	15-hole connector
Audio	microphone miniconnector, stereo headphones/speakers miniconnector
USB	two 4-pin USB 2.0-compliant connectors
Infrared sensor	sensor compatible with IrDA Standard 1.1 (Fast IR) and IrDA Standard 1.0 (Slow IR)
S-video TV-out	7-pin mini-DIN connector (optional S-video to composite video adapter cable)
Mini PCI	Type IIIA Mini PCI card slot
Modem	RJ-11 port
Network adapter	RJ-45 port
IEEE 1394	4-pin serial connector

<b>Communications</b>	
Modem:	
Type	v.92 56K MDC
Controller	softmodem
Interface	internal AC'97 bus
Network adapter	10/100 Ethernet LAN on system board
Wireless	internal Mini PCI Wi-Fi wireless support; Bluetooth™ (optional, available at point of sale only)

<b>Video</b>	
Video type	Intel UMA Integrated
Video controller	Intel 855GME Integrated chip set
Video memory	1 MB with Intel DVMT up to 32 MB (with 128 MB of system memory) or 64 MB (with 256 MB or more of system memory)
LCD interface	LVDS

<b>Audio</b>	
Audio type	compatible with Soundblaster and Microsoft® Windows® Sound

	System
Audio controller	Intel AC'97
Stereo conversion	20-bit (stereo digital-to-analog), 18-bit (stereo analog-to-digital)
Interfaces:	
Internal	AC'97
External	microphone miniconnector, stereo headphones/speakers miniconnector
Speaker	two 4-ohm speakers
Internal speaker amplifier	2-W channel into 4 ohms
Volume controls	keyboard shortcuts or program menus

<b>Display</b>	
Type (active-matrix TFT)	XGA
Dimensions:	
Height	228.1 mm (9 inches)
Width	304.1 mm (12 inches)
Diagonal	380.1 mm (15 inches)
Maximum resolutions	1024 x 768 at 16.8 million colors
Response time (typical)	25-ms rise (maximum), 35-ms fall (maximum)
Refresh rate	60 Hz
Operating angle	0° (closed) to 180°
Viewing angles:	
Horizontal	±60°
Vertical	±45°
Pixel pitch	0.2172 x 0.2172 mm
Power Consumption:	
Panel with backlight (typical)	4.6 W
Controls	brightness can be controlled through keyboard shortcuts

<b>Keyboard</b>	
Number of keys	87 (U.S. and Canada); 88 (Europe); 91 (Japan)
Key travel	2.7 mm ± 0.3 mm (0.11 inch ± 0.016 inch)
Key spacing	19.05 mm ± 0.3 mm (0.75 inch ±

	0.012 inch)
Layout	QWERTY/AZERTY/Kanji

<b>Touch Pad</b>	
X/Y position resolution (graphics table mode)	240 cpi
Size:	
Width	64.88-mm (2.55-inch) sensor-active area
Height	48.88-mm (1.92-inch) rectangle

<b>Battery</b>	
Type	6-cell "smart" lithium ion (48 WHr) 4-cell "smart" lithium ion (32 WHr)
Dimensions:	
Depth	77.5 mm (3.05 inches)
Height	19.5 mm (0.76 inch)
Width	123.4 mm (4.86 inches)
Weight	0.32 kg (0.7 lb) (6-cell battery) 0.23 kg (0.52 lb) (4-cell battery)
Voltage	11.1 VDC (6-cell battery) 14.8 VDC (4-cell battery)
Charge time with computer off (approximate)	1 hour for 80 percent charge
Operating time	approximately 3 to 4 hours (6-cell battery); approximately 2 to 2.5 hours (4-cell battery); can be significantly reduced under certain <a href="#">power-intensive conditions</a>
Life span (approximate)	300 discharge/charge cycles
Temperature range:	
Operating	0° to 35°C (32° to 95°F)
Storage	-20° to 65°C (-4° to 149°F)

<b>AC Adapter</b>	
Input voltage	90-264 VAC
Input current (maximum)	1.7 A
Input frequency	47-63 Hz
Output current	3.34A (65 W) 4.62A (90 W)
Output power	65 W or 90 W

Rated output voltage	19.5 VDC
Dimensions:	
Height	28.2mm (1.11 inches) (65 W) 34.2mm (1.35 inches) (90 W)
Width	57.9mm (2.28 inches) (65 W) 60.8mm (2.39 inches) (90 W)
Depth	137.2mm (5.40 inches) (65 W) 153.4mm (6.04 inches) (90 W)
Weight (with cables)	0.4 kg (1 lb) (90 W) 0.3 kg (.69 lb) (65 W)
Temperature range:	
Operating	0° to 35°C (32° to 95°F)
Storage	-40° to 65°C (-40° to 149°F)

<b>Computer Dimensions and Weight</b>	
Height	35.5 mm (1.40 inches)
Width	338.4 mm (13.32 inches)
Depth	273 mm (10.75 inches)
Weight:	
With travel module and standard battery	2.49 kg (5.49 lb)
With CD drive and standard battery	2.70 kg (5.94 lb)

<b>Computer Environmental</b>	
Temperature range:	
Operating	0° to 35°C (32° to 95°F)
Storage	-40° to 65°C (-40° to 149°F)
Relative humidity (maximum):	
Operating	10% to 90% (noncondensing)
Storage	5% to 95% (noncondensing)
Maximum vibration (using a random-vibration spectrum that simulates user environment):	
Operating	0.66 GRMS
Storage	1.30 GRMS
Maximum shock (measured with hard drive in head-parked position and a 2-ms half-sine pulse):	
Operating	122 G
Storage	163 G

Altitude (maximum):	
Operating	-15.2 to 3048 m (-50 to 10,000 ft)
Storage	-15.2 to 10,668 m (-50 to 35,000 ft)



# Getting Help

- [Technical Assistance](#)
  - [Problems With Your Order](#)
  - [Product Information](#)
  - [Returning Items for Warranty Repair or Credit](#)
  - [Before You Call](#)
  - [Contacting Dell](#)
- 

## Technical Assistance

If you need help with a technical problem, Dell is ready to assist you.



**CAUTION:** If you need to remove the computer covers, first disconnect the computer power and modem cables from all electrical outlets.

1. Complete the procedures in "[Solving Problems](#)."
2. Run the Dell Diagnostics.
3. Make a copy of the [Diagnostics Checklist](#) and fill it out.
4. Use Dell's extensive suite of online services available at Dell Support ([support.dell.com](http://support.dell.com)) for help with installation and troubleshooting procedures.
5. If the preceding steps have not resolved the problem, contact Dell.

**NOTE:** Call technical support from a telephone near or at the computer so that technical support can assist you with any necessary procedures.

**NOTE:** Dell's Express Service Code system may not be available in all countries.

When prompted by Dell's automated telephone system, enter your Express Service Code to route the call directly to the proper support personnel. If you do not have an Express Service Code, open the **Dell Accessories** folder, double-click the **Express Service Code** icon, and follow the directions.

For instructions on using the technical support service, see "[Technical Support Service](#)."

**NOTE:** Some of the following services are not always available in all locations outside the continental U.S. Call your local Dell representative for information on availability.

## Online Services

You can access Dell Support at **support.dell.com**. Select your region on the **WELCOME TO DELL SUPPORT** page, and fill in the requested details to access help tools and information.

You can contact Dell electronically using the following addresses:

- World Wide Web

**www.dell.com/**

**www.dell.com/ap/** (for Asian/Pacific countries only)

**www.euro.dell.com** (for Europe only)

**www.dell.com/la/** (for Latin American countries)

- Anonymous file transfer protocol (FTP)

**ftp.dell.com/**

Log in as user: `anonymous`, and use your e-mail address as your password.

- Electronic Support Service

mobile\_support@us.dell.com

support@us.dell.com

apsupport@dell.com (for Asian/Pacific countries only)

**support.euro.dell.com** (for Europe only)

- Electronic Quote Service

sales@dell.com

apmarketing@dell.com (for Asian/Pacific countries only)

- Electronic Information Service

info@dell.com

## AutoTech Service

Dell's automated technical support service—AutoTech—provides recorded answers to the questions most frequently asked by Dell customers about their portable and desktop computers.

When you call AutoTech, use your touch-tone telephone to select the subjects that correspond to your questions.

The AutoTech service is available 24 hours a day, 7 days a week. You can also access this service through the technical support service. For the telephone number to call, see the [contact numbers](#) for your region.

## Automated Order-Status Service

To check on the status of any Dell products that you have ordered, you can go to **support.dell.com**, or you can call the automated order-status service. A recording prompts you for the information needed to locate and report on your order. For the telephone number to call, see the [contact numbers](#) for your region.

## Technical Support Service

Dell's technical support service is available 24 hours a day, 7 days a week, to answer your questions about Dell hardware. Our technical support staff uses computer-based diagnostics to provide fast, accurate answers.

To contact Dell's technical support service, see "[Technical Assistance](#)" and then call the number for your country as listed in "[Contacting Dell](#)."

---

## Problems With Your Order

If you have a problem with your order, such as missing parts, wrong parts, or incorrect billing, contact Dell for customer assistance. Have your invoice or packing slip handy when you call. For the telephone number to call, see the [contact numbers](#) for your region.

---

## Product Information

If you need information about additional products available from Dell, or if you would like to place an order, visit the Dell website at **www.dell.com**. For the telephone number to call to speak to a sales specialist, see the [contact numbers](#) for your region.

---

## Returning Items for Warranty Repair or Credit

Prepare all items being returned, whether for repair or credit, as follows:

1. Call Dell to obtain a Return Material Authorization Number, and write it clearly and prominently on the outside of the box.

For the telephone number to call, see the [contact numbers](#) for your region.

2. Include a copy of the invoice and a letter describing the reason for the return.
3. Include a copy of the [Diagnostics Checklist](#) indicating the tests you have run and any error messages reported by the Dell Diagnostics.
4. Include any accessories that belong with the item(s) being returned (power cables, software floppy disks, guides, and so on) if the return is for credit.
5. Pack the equipment to be returned in the original (or equivalent) packing materials.

You are responsible for paying shipping expenses. You are also responsible for insuring any product returned, and you assume the risk of loss during shipment to Dell. Collect On Delivery (C.O.D.) packages are not accepted.

Returns that are missing any of the preceding requirements will be refused at Dell's receiving dock and returned to you.

---

## Before You Call

**NOTE:** Have your Express Service Code ready when you call. The code helps Dell's automated-support telephone system direct your call more efficiently.

Remember to fill out the [Diagnostics Checklist](#). If possible, turn on your computer before you call Dell for technical assistance and call from a telephone at or near the computer. You may be asked to type some commands at the keyboard, relay detailed information during operations, or try other troubleshooting steps possible only at the computer itself. Ensure that the computer documentation is available.



**CAUTION:** Before working inside your computer, read the safety instructions in your *System Information Guide*.

Diagnostics Checklist
Name:
Date:
Address:
Phone number:
Service tag (bar code on the back of the computer):
Express Service Code:
Return Material Authorization Number (if provided by Dell support technician):
Operating system and version:
Devices:
Expansion cards:
Are you connected to a network? Yes No
Network, version, and network adapter:
Programs and versions:
See your operating system documentation to determine the contents of the system's start-up files. If the computer is connected to a printer, print each file. Otherwise, record the contents of each file before calling Dell.
Error message, beep code, or diagnostic code:
Description of problem and troubleshooting procedures you performed:

---

## Contacting Dell

To contact Dell electronically, you can access the following websites:

- **www.dell.com**
- **support.dell.com** (technical support)
- **premiersupport.dell.com** (technical support for educational, government, healthcare, and medium/large business customers, including Premier, Platinum, and Gold customers)

For specific web addresses for your country, find the appropriate country section in the table below.

**NOTE:** Toll-free numbers are for use within the country for which they are listed.

When you need to contact Dell, use the electronic addresses, telephone numbers, and codes provided in the following table. If you need assistance in determining which codes to use, contact a local or an international operator.

<b>Country (City) International Access Code Country Code City Code</b>	<b>Department Name or Service Area, Website and E-Mail Address</b>	<b>Area Codes, Local Numbers, and Toll-Free Numbers</b>
<b>Anguilla</b>	General Support	toll-free: 800-335-0031
<b>Antigua and Barbuda</b>	General Support	1-800-805-5924
<b>Argentina (Buenos Aires)</b>  International Access Code: <b>00</b>  Country Code: <b>54</b>  City Code: <b>11</b>	Website: <b>www.dell.com.ar</b>	
	Tech Support and Customer Care	toll-free: 0-800-444-0733
	Sales	0-810-444-3355
	Tech Support Fax	11 4515 7139
	Customer Care Fax	11 4515 7138
<b>Aruba</b>	General Support	toll-free: 800-1578
<b>Australia (Sydney)</b>  International Access Code: <b>0011</b>  Country Code: <b>61</b>  City Code: <b>2</b>	E-mail (Australia): <b>au_tech_support@dell.com</b>	
	E-mail (New Zealand): <b>nz_tech_support@dell.com</b>	
	Home and Small Business	1-300-65-55-33
	Government and Business	toll-free: 1-800-633-559
	Preferred Accounts Division (PAD)	toll-free: 1-800-060-889
	Customer Care	toll-free: 1-800-819-339
	Corporate Sales	toll-free: 1-800-808-385
	Transaction Sales	toll-free: 1-800-808-312
Fax	toll-free: 1-800-818-341	
<b>Austria (Vienna)</b>  International Access Code: <b>900</b>  Country Code: <b>43</b>  City Code: <b>1</b>	Website: <b>support.euro.dell.com</b>	
	E-mail: <b>tech_support_central_europe@dell.com</b>	
	Home/Small Business Sales	0820 240 530 00
	Home/Small Business Fax	0820 240 530 49
	Home/Small Business Customer Care	0820 240 530 14

	Preferred Accounts/Corporate Customer Care	0820 240 530 16
	Home/Small Business Technical Support	0820 240 530 14
	Preferred Accounts/Corporate Technical Support	0660 8779
	Switchboard	0820 240 530 00
<b>Bahamas</b>	General Support	toll-free: 1-866-278-6818
<b>Barbados</b>	General Support	1-800-534-3066
<b>Belgium (Brussels)</b>  International Access Code: <b>00</b>  Country Code: <b>32</b>  City Code: <b>2</b>	Website: <b>support.euro.dell.com</b>	
	E-mail: tech_be@dell.com	
	E-mail for French Speaking Customers: <b>support.euro.dell.com/be/fr/emaildell/</b>	
	Technical Support	02 481 92 88
	Customer Care	02 481 91 19
	Corporate Sales	02 481 91 00
	Fax	02 481 92 99
	Switchboard	02 481 91 00
<b>Bermuda</b>	General Support	1-800-342-0671
<b>Bolivia</b>	General Support	toll-free: 800-10-0238
<b>Brazil</b>  International Access Code: <b>00</b>  Country Code: <b>55</b>  City Code: <b>51</b>	Website: <b>www.dell.com/br</b>	
	Customer Support, Technical Support	0800 90 3355
	Tech Support Fax	51 481 5470
	Customer Care Fax	51 481 5480
	Sales	0800 90 3390
<b>British Virgin Islands</b>	General Support	toll-free: 1-866-278-6820
<b>Brunei</b>  Country Code: <b>673</b>	Customer Technical Support (Penang, Malaysia)	604 633 4966
	Customer Service (Penang, Malaysia)	604 633 4949
	Transaction Sales (Penang, Malaysia)	604 633 4955
<b>Canada (North York, Ontario)</b>  International Access Code: <b>011</b>	Online Order Status: <b>www.dell.ca/ostatus</b>	
	AutoTech (automated technical support)	toll-free: 1-800-247-9362
	TechFax	toll-free: 1-800-950-1329
	Customer Care (Home Sales/Small Business)	toll-free: 1-800-847-4096
	Customer Care (med./large business, government)	toll-free: 1-800-326-9463
	Technical Support (Home Sales/Small Business)	toll-free: 1-800-847-4096
	Technical Support (med./large bus., government)	toll-free: 1-800-387-5757
	Sales (Home Sales/Small Business)	toll-free: 1-800-387-5752
	Sales (med./large bus., government)	toll-free: 1-800-387-5755
	Spare Parts Sales & Extended Service Sales	1 866 440 3355

<b>Cayman Islands</b>	General Support	1-800-805-7541
<b>Chile (Santiago)</b>	Sales, Customer Support, and Technical Support	toll-free: 1230-020-4823
Country Code: <b>56</b>		
City Code: <b>2</b>		
<b>China (Xiamen)</b>	Tech Support website: <b>support.ap.dell.com/china</b>	
Country Code: <b>86</b>	Tech Support E-mail: cn_support@dell.com	
City Code: <b>592</b>	Tech Support Fax	818 1350
	Home and Small Business Technical Support	toll-free: 800 858 2437
	Corporate Accounts Technical Support	toll-free: 800 858 2333
	Customer Experience	toll-free: 800 858 2060
	Home and Small Business	toll-free: 800 858 2222
	Preferred Accounts Division	toll-free: 800 858 2062
	Large Corporate Accounts GCP	toll-free: 800 858 2055
	Large Corporate Accounts Key Accounts	toll-free: 800 858 2628
	Large Corporate Accounts North	toll-free: 800 858 2999
	Large Corporate Accounts North Government and Education	toll-free: 800 858 2955
	Large Corporate Accounts East	toll-free: 800 858 2020
	Large Corporate Accounts East Government and Education	toll-free: 800 858 2669
	Large Corporate Accounts Queue Team	toll-free: 800 858 2572
	Large Corporate Accounts South	toll-free: 800 858 2355
	Large Corporate Accounts West	toll-free: 800 858 2811
	Large Corporate Accounts Spare Parts	toll-free: 800 858 2621
<b>Colombia</b>	General Support	980-9-15-3978
<b>Costa Rica</b>	General Support	0800-012-0435
<b>Czech Republic (Prague)</b>	Website: <b>support.euro.dell.com</b>	
	E-mail: czech_dell@dell.com	
International Access Code: <b>00</b>	Technical Support	02 2186 27 27
	Customer Care	02 2186 27 11
Country Code: <b>420</b>	Fax	02 2186 27 14
City Code: <b>2</b>	TechFax	02 2186 27 28
	Switchboard	02 2186 27 11
<b>Denmark (Copenhagen)</b>	Website: <b>support.euro.dell.com</b>	
International Access Code: <b>00</b>	E-mail Support (portable computers): den_nbk_support@dell.com	
	E-mail Support (desktop computers):	

Country Code: <b>45</b>	den_support@dell.com	
	E-mail Support (servers): Nordic_server_support@dell.com	
	Technical Support	7023 0182
	Customer Care (Relational)	7023 0184
	Home/Small Business Customer Care	3287 5505
	Switchboard (Relational)	3287 1200
	Fax Switchboard (Relational)	3287 1201
	Switchboard (Home/Small Business)	3287 5000
	Fax Switchboard (Home/Small Business)	3287 5001
<b>Dominica</b>	General Support	toll-free: 1-866-278-6821
<b>Dominican Republic</b>	General Support	1-800-148-0530
<b>Ecuador</b>	General Support	toll-free: 999-119
<b>El Salvador</b>	General Support	01-899-753-0777
<b>Finland (Helsinki)</b>  International Access Code: <b>990</b>  Country Code: <b>358</b>  City Code: <b>9</b>	Website: <b>support.euro.dell.com</b>	
	E-mail: fin_support@dell.com	
	E-mail Support (servers): Nordic_support@dell.com	
	Technical Support	09 253 313 60
	Technical Support Fax	09 253 313 81
	Relational Customer Care	09 253 313 38
	Home/Small Business Customer Care	09 693 791 94
	Fax	09 253 313 99
	Switchboard	09 253 313 00
<b>France (Paris) (Montpellier)</b>  International Access Code: <b>00</b>  Country Code: <b>33</b>  City Codes: <b>(1) (4)</b>	Website: <b>support.euro.dell.com</b>	
	E-mail: <b>support.euro.dell.com/fr/fr/emaildell/</b>	
	<b>Home and Small Business</b>	
	Technical Support	0825 387 270
	Customer Care	0825 823 833
	Switchboard	0825 004 700
	Switchboard (calls from outside of France)	04 99 75 40 00
	Sales	0825 004 700
	Fax	0825 004 701
	Fax (calls from outside of France)	04 99 75 40 01
	<b>Corporate</b>	
	Technical Support	0825 004 719
	Customer Care	0825 338 339
	Switchboard	01 55 94 71 00



	Sales	01 55 94 71 00
	Fax	01 55 94 71 01
<b>Germany (Langen)</b>	Website: <b>support.euro.dell.com</b>	
International Access Code: <b>00</b>	E-mail: tech_support_central_europe@dell.com	
Country Code: <b>49</b>	Technical Support	06103 766-7200
City Code: <b>6103</b>	Home/Small Business Customer Care	0180-5-224400
	Global Segment Customer Care	06103 766-9570
	Preferred Accounts Customer Care	06103 766-9420
	Large Accounts Customer Care	06103 766-9560
	Public Accounts Customer Care	06103 766-9555
	Switchboard	06103 766-7000
<b>Greece</b>	Website: <b>support.euro.dell.com</b>	
International Access Code: 00	E-mail: support.euro.dell.com/gr/en/emaildell/	
Country Code: 30	Technical Support	080044149518
	Gold Technical Support	08844140083
	Switchboard	2108129800
	Sales	2108129800
	Fax	2108129812
<b>Grenada</b>	General Support	toll-free: 1-866-540-3355
<b>Guatemala</b>	General Support	1-800-999-0136
<b>Guyana</b>	General Support	toll-free: 1-877-270-4609
<b>Hong Kong</b>	Website: <b>support.ap.dell.com</b>	
International Access Code: <b>001</b>	E-mail: ap_support@dell.com	
Country Code: <b>852</b>	Technical Support (Dimension™ and Inspiron™)	296 93188
	Technical Support (OptiPlex™, Latitude™, and Dell Precision™)	296 93191
	Customer Service (non-technical, post-sales issues)	800 93 8291
	Transaction Sales	toll-free: 800 96 4109
	Large Corporate Accounts HK	toll-free: 800 96 4108
	Large Corporate Accounts GCP HK	toll-free: 800 90 3708
<b>India</b>	Technical Support	1600 33 8045
	Sales	1600 33 8044
<b>Ireland (Cherrywood)</b>	Website: <b>support.euro.dell.com</b>	
International Access Code: <b>16</b>	E-mail: dell_direct_support@dell.com	
Country Code: <b>353</b>	Ireland Technical Support	1850 543 543
	U.K. Technical Support (dial within U.K. only)	0870 908 0800
	Home User Customer Care	01 204 4014

City Code: <b>1</b>	Small Business Customer Care	01 204 4014
	U.K. Customer Care (dial within U.K. only)	0870 906 0010
	Corporate Customer Care	1850 200 982
	Corporate Customer Care (dial within U.K. only)	0870 907 4499
	Ireland Sales	01 204 4444
	U.K. Sales (dial within U.K. only)	0870 907 4000
	Fax/SalesFax	01 204 0103
	Switchboard	01 204 4444
<b>Italy (Milan)</b>  International Access Code: <b>00</b>  Country Code: <b>39</b>  City Code: <b>02</b>	Website: <b>support.euro.dell.com</b>	
	E-mail: <b>support.euro.dell.com/it/it/emaildell/</b>	
	<b>Home and Small Business</b>	
	Technical Support	02 577 826 90
	Customer Care	02 696 821 14
	Fax	02 696 821 13
	Switchboard	02 696 821 12
	<b>Corporate</b>	
	Technical Support	02 577 826 90
	Customer Care	02 577 825 55
	Fax	02 575 035 30
	Switchboard	02 577 821
	<b>Jamaica</b>	General Support (dial from within Jamaica only)
<b>Japan (Kawasaki)</b>  International Access Code: <b>001</b>  Country Code: <b>81</b>  City Code: <b>44</b>	Website: <b>support.jp.dell.com</b>	
	Technical Support (servers)	toll-free: 0120-198-498
	Technical Support outside of Japan (servers)	81-44-556-4162
	Technical Support (Dimension™ and Inspiron™)	toll-free: 0120-198-226
	Technical Support outside of Japan (Dimension and Inspiron)	81-44-520-1435
	Technical Support (Dell Precision™, OptiPlex™, and Latitude™)	toll-free:0120-198-433
	Technical Support outside of Japan (Dell Precision, OptiPlex, and Latitude)	81-44-556-3894
	Faxbox Service	044-556-3490
	24-Hour Automated Order Service	044-556-3801
	Customer Care	044-556-4240
	Business Sales Division (up to 400 employees)	044-556-1465
	Preferred Accounts Division Sales (over 400 employees)	044-556-3433
	Large Corporate Accounts Sales (over 3500 employees)	044-556-3430

	Public Sales (government agencies, educational institutions, and medical institutions)	044-556-1469
	Global Segment Japan	044-556-3469
	Individual User	044-556-1760
	Switchboard	044-556-4300
<b>Korea (Seoul)</b>  International Access Code: <b>001</b>  Country Code: <b>82</b>  City Code: <b>2</b>	Technical Support	toll-free: 080-200-3800
	Sales	toll-free: 080-200-3600
	Customer Service (Seoul, Korea)	toll-free: 080-200-3800
	Customer Service (Penang, Malaysia)	604 633 4949
	Fax	2194-6202
	Switchboard	2194-6000
<b>Latin America</b>	Customer Technical Support (Austin, Texas, U.S.A.)	512 728-4093
	Customer Service (Austin, Texas, U.S.A.)	512 728-3619
	Fax (Technical Support and Customer Service) (Austin, Texas, U.S.A.)	512 728-3883
	Sales (Austin, Texas, U.S.A.)	512 728-4397
	SalesFax (Austin, Texas, U.S.A.)	512 728-4600 or 512 728-3772
<b>Luxembourg</b>  International Access Code: <b>00</b>  Country Code: <b>352</b>	Website: <b>support.euro.dell.com</b>	
	E-mail: tech_be@dell.com	
	Technical Support (Brussels, Belgium)	3420808075
	Home/Small Business Sales (Brussels, Belgium)	toll-free: 080016884
	Corporate Sales (Brussels, Belgium)	02 481 91 00
	Customer Care (Brussels, Belgium)	02 481 91 19
	Fax (Brussels, Belgium)	02 481 92 99
	Switchboard (Brussels, Belgium)	02 481 91 00
<b>Macao</b>  Country Code: <b>853</b>	Technical Support	toll-free: 0800 582
	Customer Service (Penang, Malaysia)	604 633 4949
	Transaction Sales	toll-free: 0800 581
<b>Malaysia (Penang)</b>  International Access Code: <b>00</b>  Country Code: <b>60</b>  City Code: <b>4</b>	Technical Support	toll-free: 1 800 888 298
	Customer Service	04 633 4949
	Transaction Sales	toll-free: 1 800 888 202
	Corporate Sales	toll-free: 1 800 888 213
<b>Mexico</b>  International Access	Customer Technical Support	001-877-384-8979 or 001-877-269-3383

Code: <b>00</b>	Sales	50-81-8800
Country Code: <b>52</b>		or 01-800-888-3355
	Customer Service	001-877-384-8979
		or 001-877-269-3383
	Main	50-81-8800
		or 01-800-888-3355
<b>Montserrat</b>	General Support	toll-free: 1-866-278-6822
<b>Netherlands Antilles</b>	General Support	001-800-882-1519
<b>Netherlands (Amsterdam)</b>	Website: <b>support.euro.dell.com</b>	
International Access Code: <b>00</b>	E-mail (Technical Support):	
Country Code: <b>31</b>	(Enterprise): nl_server_support@dell.com	
City Code: <b>20</b>	(Latitude): nl_latitude_support@dell.com	
	(Inspiron): nl_inspiron_support@dell.com	
	(Dimension): nl_dimension_support@dell.com	
	(OptiPlex): nl_optiplex_support@dell.com	
	(Dell Precision): nl_workstation_support@dell.com	
	Technical Support	020 674 45 00
	Technical Support Fax	020 674 47 66
	Home/Small Business Customer Care	020 674 42 00
	Relational Customer Care	020 674 4325
	Home/Small Business Sales	020 674 55 00
	Relational Sales	020 674 50 00
	Home/Small Business Sales Fax	020 674 47 75
	Relational Sales Fax	020 674 47 50
	Switchboard	020 674 50 00
	Switchboard Fax	020 674 47 50
<b>New Zealand</b>	E-mail (New Zealand): nz_tech_support@dell.com	
International Access Code: <b>00</b>	E-mail (Australia): au_tech_support@dell.com	
Country Code: <b>64</b>	Home and Small Business	0800 446 255
	Government and Business	0800 444 617
	Sales	0800 441 567
	Fax	0800 441 566
<b>Nicaragua</b>	General Support	001-800-220-1006

<b>Norway (Lysaker)</b>  International Access Code: <b>00</b>  Country Code: <b>47</b>	Website: <b>support.euro.dell.com</b>	
	E-mail Support (portable computers): nor_nbk_support@dell.com	
	E-mail Support (desktop computers): nor_support@dell.com	
	E-mail Support (servers): nordic_server_support@dell.com	
	Technical Support	671 16882
	Relational Customer Care	671 17514
	Home/Small Business Customer Care	23162298
	Switchboard	671 16800
	Fax Switchboard	671 16865
	<b>Panama</b>	General Support
<b>Peru</b>	General Support	0800-50-669
<b>Poland (Warsaw)</b>  International Access Code: <b>011</b>  Country Code: <b>48</b>  City Code: <b>22</b>	Website: <b>support.euro.dell.com</b>	
	E-mail: pl_support@dell.com	
	Customer Service Phone	57 95 700
	Customer Care	57 95 999
	Sales	57 95 999
	Customer Service Fax	57 95 806
	Reception Desk Fax	57 95 998
	Switchboard	57 95 999
<b>Portugal</b>  International Access Code: <b>00</b>  Country Code: <b>351</b>	Website: <b>support.euro.dell.com</b>	
	E-mail: <b>support.euro.dell.com/pt/en/emaiddell/</b>	
	Technical Support	707200149
	Customer Care	800 300 413
	Sales	800 300 410 or 800 300 411 or 800 300 412 or 21 422 07 10
	Fax	21 424 01 12
<b>Puerto Rico</b>	General Support	1-800-805-7545
<b>St. Kitts and Nevis</b>	General Support	toll-free: 1-877-441-4731
<b>St. Lucia</b>	General Support	1-800-882-1521
<b>St. Vincent and the Grenadines</b>	General Support	toll-free: 1-877-270-4609
<b>Singapore</b>	Technical Support	toll-free: 800 6011 051

<b>(Singapore)</b>  International Access Code: <b>005</b>  Country Code: <b>65</b>	Customer Service (Penang, Malaysia)	604 633 4949
	Transaction Sales	toll-free: 800 6011 054
	Corporate Sales	toll-free: 800 6011 053
<b>South Africa (Johannesburg)</b>  International Access Code:  <b>09/091</b>  Country Code: <b>27</b>  City Code: <b>11</b>	Website: <b>support.euro.dell.com</b>	
	E-mail: dell_za_support@dell.com	
	Technical Support	011 709 7710
	Customer Care	011 709 7707
	Sales	011 709 7700
	Fax	011 706 0495
	Switchboard	011 709 7700
<b>Southeast Asian and Pacific Countries</b>	Customer Technical Support, Customer Service, and Sales (Penang, Malaysia)	604 633 4810
<b>Spain (Madrid)</b>  International Access Code: <b>00</b>  Country Code: <b>34</b>  City Code: <b>91</b>	Website: <b>support.euro.dell.com</b>	
	E-mail: <b>support.euro.dell.com/es/es/emaildell/</b>	
	<b>Home and Small Business</b>	
	Technical Support	902 100 130
	Customer Care	902 118 540
	Sales	902 118 541
	Switchboard	902 118 541
	Fax	902 118 539
	<b>Corporate</b>	
	Technical Support	902 100 130
	Customer Care	902 118 546
	Switchboard	91 722 92 00
	Fax	91 722 95 83
<b>Sweden (Upplands Vasby)</b>  International Access Code: <b>00</b>  Country Code: <b>46</b>  City Code: <b>8</b>	Website: <b>support.euro.dell.com</b>	
	E-mail: swe_support@dell.com	
	E-mail Support for Latitude and Inspiron: Swe-nbk_kats@dell.com	
	E-mail Support for OptiPlex: Swe_kats@dell.com	
	E-mail Support for Servers: Nordic_server_support@dell.com	
	Technical Support	08 590 05 199
	Relational Customer Care	08 590 05 642
	Home/Small Business Customer Care	08 587 70 527
Employee Purchase Program (EPP) Support	20 140 14 44	

	Fax Technical Support	08 590 05 594
	Sales	08 590 05 185
<b>Switzerland (Geneva)</b>  International Access Code: <b>00</b>  Country Code: <b>41</b>  City Code: <b>22</b>	Website: <b>support.euro.dell.com</b>	
	E-mail: swisstech@dell.com	
	E-mail for French-speaking HSB and Corporate Customers: <b>support.euro.dell.com/ch/fr/emaildell/</b>	
	Technical Support (Home and Small Business)	0844 811 411
	Technical Support (Corporate)	0844 822 844
	Customer Care (Home and Small Business)	0848 802 202
	Customer Care (Corporate)	0848 821 721
	Fax	022 799 01 90
	Switchboard	022 799 01 01
<b>Taiwan</b>  International Access Code: <b>002</b>  Country Code: <b>886</b>	Technical Support (portable and desktop computers)	toll-free: 00801 86 1011
	Technical Support (servers)	toll-free: 0080 60 1256
	Transaction Sales	toll-free: 0080 651 228 or 0800 33 556
	Corporate Sales	toll-free: 0080 651 227 or 0800 33 555
<b>Thailand</b>  International Access Code: <b>001</b>  Country Code: <b>66</b>	Technical Support	toll-free: 0880 060 07
	Customer Service (Penang, Malaysia)	604 633 4949
	Sales	toll-free: 0880 060 09
<b>Trinidad/Tobago</b>	General Support	1-800-805-8035
<b>Turks and Caicos Islands</b>	General Support	toll-free: 1-866-540-3355
<b>U.K. (Bracknell)</b>  International Access Code: <b>00</b>  Country Code: <b>44</b>  City Code: <b>1344</b>	Website: <b>support.euro.dell.com</b>	
	Customer Care website: <b>support.euro.dell.com/uk/en/ECare/Form/Home.asp</b>	
	E-mail: dell_direct_support@dell.com	
	Technical Support (Corporate/Preferred Accounts/PAD [1000+ employees])	0870 908 0500
	Technical Support (direct/PAD and general)	0870 908 0800
	Global Accounts Customer Care	01344 373 186
	Home and Small Business Customer Care	0870 906 0010
	Corporate Customer Care	01344 373 185

	Preferred Accounts (500-5000 employees) Customer Care	0870 906 0010
	Central Government Customer Care	01344 373 193
	Local Government & Education Customer Care	01344 373 199
	Health Customer Care	01344 373 194
	Home and Small Business Sales	0870 907 4000
	Corporate/Public Sector Sales	01344 860 456
<b>Uruguay</b>	General Support	toll-free: 000-413-598-2521
<b>U.S.A. (Austin, Texas)</b>  International Access Code: <b>011</b>  Country Code: <b>1</b>	Automated Order-Status Service	toll-free: 1-800-433-9014
	AutoTech (portable and desktop computers)	toll-free: 1-800-247-9362
	<b>Consumer</b> (Home and Home Office)	
	Technical Support	toll-free: 1-800-624-9896
	Customer Service	toll-free: 1-800-624-9897
	DellNet™ Service and Support	toll-free: 1-877-Dellnet (1-877-335-5638)
	Employee Purchase Program (EPP) Customers	toll-free: 1-800-695-8133
	Financial Services website: <b>www.dellfinancialservices.com</b>	
	Financial Services (lease/loans)	toll-free: 1-877-577-3355
	Financial Services (Dell Preferred Accounts [DPA])	toll-free: 1-800-283-2210
	<b>Business</b>	
	Customer Service and Technical Support	toll-free: 1-800-822-8965
	Employee Purchase Program (EPP) Customers	toll-free: 1-800-695-8133
	Projectors Technical Support	toll-free: 1-877-459-7298
	<b>Public</b> (government, education, and healthcare)	
	Customer Service and Technical Support	toll-free: 1-800-456-3355
	Employee Purchase Program (EPP) Customers	toll-free: 1-800-234-1490
	Dell Sales	toll-free: 1-800-289-3355 or toll-free: 1-800-879-3355
	Dell Outlet Store (Dell refurbished computers)	toll-free: 1-888-798-7561
	Software and Peripherals Sales	toll-free: 1-800-671-3355
Spare Parts Sales	toll-free: 1-800-357-3355	
Extended Service and Warranty Sales	toll-free: 1-800-247-4618	
Fax	toll-free: 1-800-727-8320	
Dell Services for the Deaf, Hard-of-Hearing, or Speech-Impaired	toll-free: 1-877-DELLTTY (1-877-335-5889)	



<b>U.S. Virgin Islands</b>	General Support	1-877-673-3355
<b>Venezuela</b>	General Support	8001-3605

# Using the System Setup Program

- [Overview](#)
  - [Viewing the System Setup Screens](#)
  - [System Setup Screens](#)
  - [Commonly Used Options](#)
- 

## Overview

 **NOTE:** Your operating system may automatically configure most of the options available in the system setup program, thus overriding options that you set through the system setup program. (An exception is the **External Hot Key** option, which you can disable or enable only through the system setup program.) For more information on configuring features for your operating system, see your Microsoft® Windows® *Help* or the Windows Help and Support Center.

You can use the system setup program as follows:

- To set or change user-selectable features—for example, your password
- To verify information about the computer's current configuration, such as the amount of system memory

After you set up the computer, run the system setup program to familiarize yourself with your system configuration information and optional settings. You may want to write down the information for future reference.

 **NOTICE:** Unless you are an expert computer user or are directed to do so by Dell technical support, do not change the settings for this program. Certain changes might make your computer work incorrectly.

---

## Viewing the System Setup Screens

1. Turn on (or restart) your computer.
  2. When the DELL™ logo appears, press <F2> immediately. If you wait too long and the Windows logo appears, continue to wait until you see the Windows desktop. Then shut down your computer and try again.
- 

## System Setup Screens

The system setup screens display the current setup information and settings for your computer. On each

screen, the system setup options are listed at the left of the screen. To the right of each option is the setting or value for that option. You can change settings that appear as white type on the screen. Options or values that you cannot change (because they are determined by the computer) appear less bright.

The upper-right corner of the screen displays help information for the currently highlighted option; the lower-right corner displays information about the computer. System setup key functions are listed across the bottom of the screen.

The screens display such information as:

- System configuration
- Boot order
- Boot (start-up) configuration and docking-device configuration settings
- Basic device configuration settings
- Battery charge status
- System security and hard-drive password settings

---

## Commonly Used Options

Certain options require that you reboot the computer for new settings to take effect.

## Changing the Boot Sequence

The *boot sequence*, or *boot order*, tells the computer where to look to find the software needed to start the operating system. You can control the boot sequence using the **Boot Order** page of the system setup program.

The **Boot Order** page displays a general list of the bootable devices that may be installed in your computer, including but not limited to the following:

- **Diskette Drive**
- **Modular bay HDD**
- **Internal HDD**
- **CD/DVD/CD-RW drive**

During the boot routine, the computer starts at the top of the list and scans each enabled device for the operating system start-up files. When the computer finds the files, it stops searching and starts the operating system.

To control the boot devices, select (highlight) a device by pressing the up-arrow key or down-arrow key, and then enable or disable the device or change its order in the list.

- To enable or disable a device, highlight the item and press the space-bar key. Enabled items appear as white and display a small triangle to their left; disabled items appear blue or dimmed without a triangle.
- To reorder a device in the list, highlight the device and then press <U> or <D> (not case-sensitive) to

move the highlighted device up or down.

Boot sequence changes take effect as soon as you save the changes and exit the system setup program.

## Performing a One-Time Boot

You can set a one-time-only boot sequence without entering the system setup program. (You can also use this procedure to boot the Dell Diagnostics on the diagnostics utility partition on your hard drive.)

1. Shut down the computer.
2. Connect the computer to an electrical outlet.
3. Turn on the computer. When the DELL logo appears, press <F12> immediately. If you wait too long and the Windows logo appears, continue to wait until you see the Windows desktop. Then shut down your computer and try again.
4. When the boot device list appears, highlight the device from which you want to boot and press <Enter>.

The computer boots to the selected device.

The next time you reboot the computer, the normal boot order is restored.

## Changing Printer Modes

Set the **Parallel Mode** option according to the type of printer or device connected to the parallel connector. To determine the correct mode to use, see the documentation that came with the device.

Setting **Parallel Mode** to **Disabled** disables the parallel port and the port's LPT address, freeing its interrupt for another device to use.

## Changing COM Ports

**Serial Port** allows you to map the serial port COM address or disable the serial port and its address, freeing its interrupt for another device to use.

## Enabling the Infrared Sensor

1. Enter the system setup program:
  - a. Turn on your computer.
  - b. Press <F2> when the DELL logo appears.
2. Press <Alt><P> until you locate **Infrared Data Port** under **Basic Device Configuration**.
3. Press the down-arrow key to highlight **Disabled** next to **Infrared Data Port**.
4. Press the right-arrow key to change the setting to a COM port.

Ensure that the COM port that you select is different from the COM port assigned to the serial connector.

5. Press the down-arrow key to select **Infrared Mode**, and press the right-arrow key to change the

setting to **Fast IR** or **Slow IR**.

It is recommended that you use **Fast IR**. If the infrared device cannot communicate with your computer, turn off the computer and repeat steps 1 through 5 to change the setting to **Slow IR**.

6. Press <Esc> to save the changes and exit the system setup program.

If you are prompted to restart your computer, click **Yes**.

7. Follow the instructions on the screen while the infrared sensor driver is being installed.
8. At the end of the installation process, click **Yes** to restart the computer.

After you enable the infrared sensor, you can use it to establish a link to an infrared device. To set up and use an infrared device, see the infrared device documentation and Windows *Help*.

# Adding and Replacing Parts

- [Before You Begin](#)
  - [Recommended Tools](#)
  - [Shutting Down Your Computer](#)
  - [Memory](#)
  - [Keyboard](#)
  - [Bluetooth™](#)
  - [Mini PCI Card](#)
  - [Hard Drive](#)
  - [Connecting a Television to the Computer](#)
- 

## Before You Begin

This section provides procedures for removing and installing the components in your computer. Unless otherwise noted, each procedure assumes that the following conditions exist:

- You have performed the steps in "[Shutting Down Your Computer](#)."
  - You have read the safety information in your *System Information Guide*.
- 

## Recommended Tools

The procedures in this document may require the following tools:

- Small flat-blade screwdriver
  - Phillips screwdriver
  - Small plastic scribe
  - Flash BIOS update program floppy disk or CD
- 

## Shutting Down Your Computer

Use the following safety guidelines to help protect your computer from potential damage and to ensure your own personal safety.



**CAUTION:** Before you begin any of the procedures in this section, follow the safety instructions in the *System Information Guide*.



**NOTICE:** Only a certified service technician should perform repairs on your computer. Damage due to servicing that is not authorized by Dell is not covered by your warranty.



**CAUTION:** Handle components and cards with care. Do not touch the components or contacts on a card. Hold a card by its edges or by its metal mounting bracket. Hold a component such as a microprocessor by its edges, not by its pins.



**NOTICE:** When you disconnect a cable, pull on its connector or on its strain-relief loop, not on the cable itself. Some cables have a connector with locking tabs; if you are disconnecting this type of cable, press in on the locking tabs before you disconnect the cable. As you pull connectors apart, keep them evenly aligned to avoid bending any connector pins. Also, before you connect a cable, ensure that both connectors are correctly oriented and aligned.



**NOTICE:** To avoid damaging the computer, perform the following steps before you begin working inside the computer.

1. Ensure that the work surface is flat and clean to prevent the computer cover from being scratched.
2. Shut down the computer.
3. Ensure that the computer and any attached devices are turned off. If your computer and attached devices did not automatically turn off when you shut down your computer, press and hold the power button for 4 seconds.
4. If the computer is connected to a docking device (docked), undock it. See the documentation that came with your docking device for instructions.



**NOTICE:** To disconnect a network cable, first unplug the cable from your computer and then unplug it from the network wall jack.

5. Disconnect any telephone or telecommunication lines from the computer.
6. Disconnect your computer and all attached devices from their electrical outlets, and then press the power button to ground the system board.



**NOTICE:** To connect a network cable, first plug the cable into the network wall jack and then plug it into the computer.

7. Remove any installed PC Cards from the PC Card slot.
8. Close the display and turn the computer upside down on a flat work surface.



**NOTICE:** To avoid damaging the system board, you must remove the main battery before you service the computer.

9. Slide and hold the battery-bay latch release on the bottom of the computer, and then remove the battery from the bay.
10. Remove any installed modules, including a second battery, if installed.
11. Remove the hard drive.

## Memory

You can increase your computer memory by installing memory modules on the system board. See "[Specifications](#)" for information on the memory supported by your computer. Be sure to add only memory modules that are intended for your computer.

 **NOTE:** Memory modules purchased from Dell are covered under your computer warranty.

 **CAUTION:** Before working inside your Dell™ computer, read the safety instructions in your *System Information Guide*.

1. Turn the computer over, remove the screw from the memory module cover, and lift the cover.

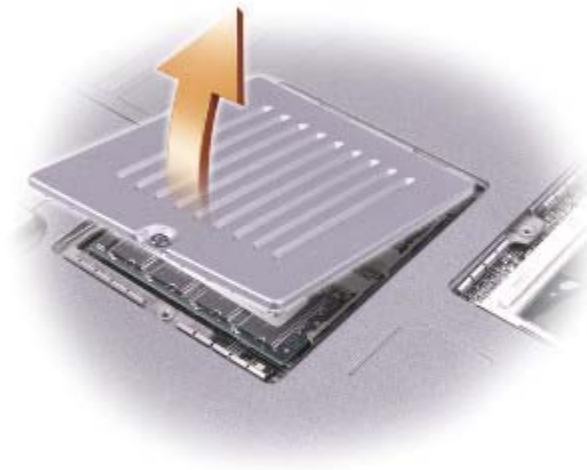

 **NOTICE:** To prevent damage to the memory module connector, do not use tools to spread the inner metal tabs that secure the memory module.

2. If you are replacing a memory module, remove the existing module.

 **NOTICE:** Handle memory modules by their edges, and do not touch the components on a module.

- a. Use your fingertips to carefully spread apart the securing clips on each end of the memory module connector until the module pops up.
- b. Remove the module from the connector.



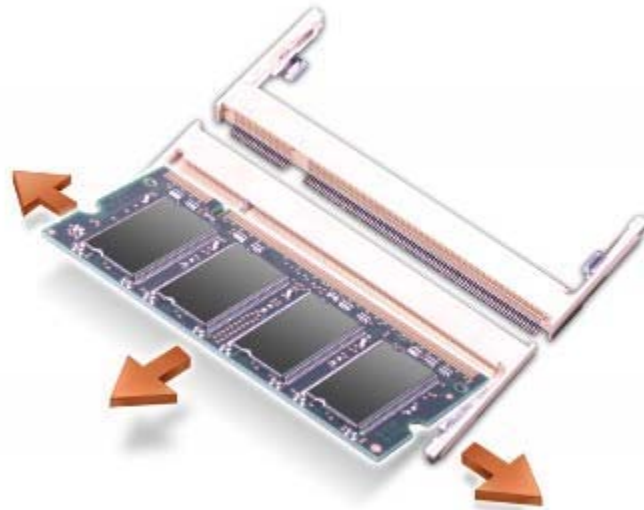

- ➔ **NOTICE:** If you need to install memory modules in two connectors, install a memory module in the connector labeled "JDIM (DIMMA)" before you install a module in the connector labeled "JDIM2 (DIMMB)."
3. Ground yourself and install the new memory module:
    - a. Align the notch in the module with the slot in the center of the connector.
    - b. Slide the edge of the module firmly into the connector, and rotate the module down until you feel a click. If you do not feel the click, remove the module and reinstall it.
- 🔪 **NOTE:** If the memory module is not installed properly, the computer does not boot. No error message indicates this failure.
4. Replace the cover and screw.
- ➔ **NOTICE:** If the memory module cover is difficult to close, remove the module and reinstall it. Forcing the cover to close may damage your computer.
5. Insert the battery into the battery bay, or connect the AC adapter to your computer and an electrical outlet.
  6. Turn on the computer.

As the computer boots, it detects the additional memory and automatically updates the system configuration information.

---

## Keyboard

⚠ **CAUTION:** Before performing the following procedures, read the safety instructions in your *System Information Guide*.

**NOTICE:** To avoid electrostatic discharge, ground yourself by using a wrist grounding strap or by

➡ periodically touching an unpainted metal surface (such as the back panel) on the computer."

1. Turn the computer top-side up and open it.



1	display
2	center control cover
3	palm rest

2. Remove the center control cover:
  - a. Open the display all the way (180 degrees) so that it lies flat against your work surface.
  - b. Starting on the right side of the computer, use a plastic scribe to pry up the center control cover. Lift it away from the computer, and lay it aside.



1	center control cover
---	----------------------

3. Remove the keyboard:

- a. Remove the two M2.5 x 6-mm screws across the top of the keyboard.

**➡ NOTICE:** The keycaps on the keyboard are fragile, easily dislodged, and time-consuming to replace. Be careful when removing and handling the keyboard.

- b. Rotate the keyboard up and slide it forward.
- c. Hold the keyboard up and slightly forward to allow access to the keyboard connector.
- d. Pull up on the keyboard connector tab to disconnect the keyboard connector from the system board.



1	M2.5 x 6-mm screws (2)
2	keyboard tabs
3	palm rest



**NOTE:** When you replace the keyboard, ensure that the keyboard tabs are completely in place to avoid scratching the palm rest.

## Bluetooth™

If you ordered a Bluetooth card with your computer, the card is already installed.



**CAUTION:** Before working inside your computer, read the safety instructions in your *System Information Guide*.

1. Ensure that the work surface is flat and clean to prevent scratching the computer cover.
2. Save and close any open files, exit any open programs, and then shut down the computer.
3. If the computer is connected to a docking device (docked), undock it. See the documentation that came with your docking device for instructions.
4. Disconnect the computer from the electrical outlet.
5. Wait 10 to 20 seconds, and then disconnect any attached devices.
6. Remove any installed PC Cards, batteries, and module bay devices.



**NOTICE:** Handle components and cards by their edges, and avoid touching pins and contacts. Ground yourself by touching a metal connector on the back of the computer. Continue to ground yourself periodically during this procedure.

7. Remove the [Hard Drive](#).

8. Pull the Bluetooth card connector out of the system board connector.
9. Pull the cable to remove the Bluetooth card from the computer.

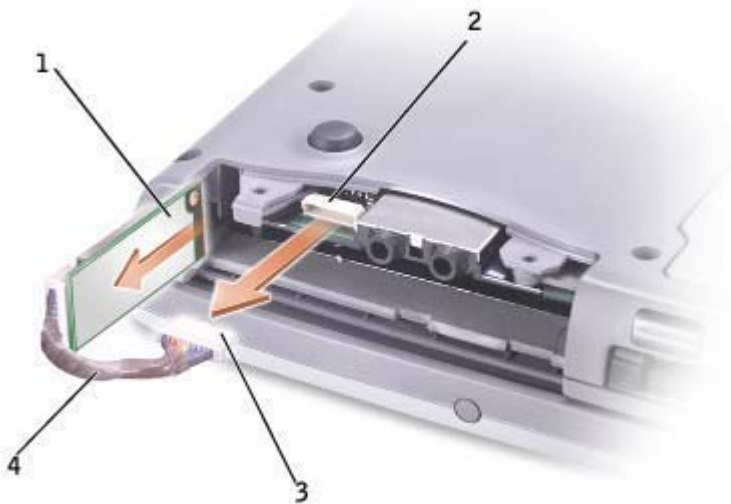

1	Bluetooth card
2	system board connector
3	Bluetooth card connector
4	cable

 **NOTE:** When replacing the Bluetooth card, ensure the Bluetooth cable is routed correctly so that you do not damage the cable when you install the hard drive.

## Mini PCI Card

 **CAUTION:** FCC rules strictly prohibit users from installing 5-GHz (802.11a, 802.11a/b, 802.11a/b/g) Wireless LAN Mini PCI cards. Under no circumstances should the user install such a device. Only trained Dell service personnel are authorized to install a 5-GHz Wireless LAN Mini PCI card.

If you are removing and/or installing a 2.4-GHz (802.11b, 802.11b/g) Mini PCI card, follow the instructions noted below. Only products approved for use in your portable computer may be installed. Approved Mini PCI cards may be purchased only from Dell.

 **NOTE:** 2.4-GHz Wireless LAN PC Cards may be removed and installed by the user.

If you ordered a Mini PCI card at the same time that you ordered your computer, the card is already installed.

 **NOTE:** Handle components and cards by their edges, and avoid touching pins and contacts.

 **CAUTION:** Before working inside your computer, read the safety instructions in your *System*

**Information Guide.**

1. Turn the computer over, and remove the screw from the Mini PCI card cover.



2. Place your finger under the cover at the indentation, and lift and slide the cover open.

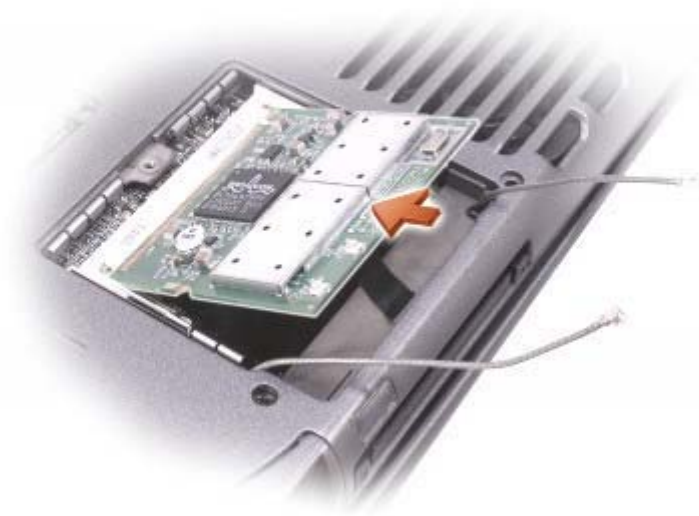

3. If a Mini PCI card is not already installed, go to [step 6](#). If you are replacing a Mini PCI card, remove the existing card:
  - a. Disconnect the Mini PCI card from any attached cables.
  - b. Release the Mini PCI card by spreading the metal securing tabs until the card pops up slightly.
  - c. Lift the Mini PCI card out of its connector.
4. Align the new Mini PCI card with the connector at a 45-degree angle, and press the Mini PCI card into the connector.

5. Connect the antenna cables from the Mini PCI card to the antenna connectors on the computer.

**NOTICE:** The connectors are keyed for correct insertion; do not force the connections.

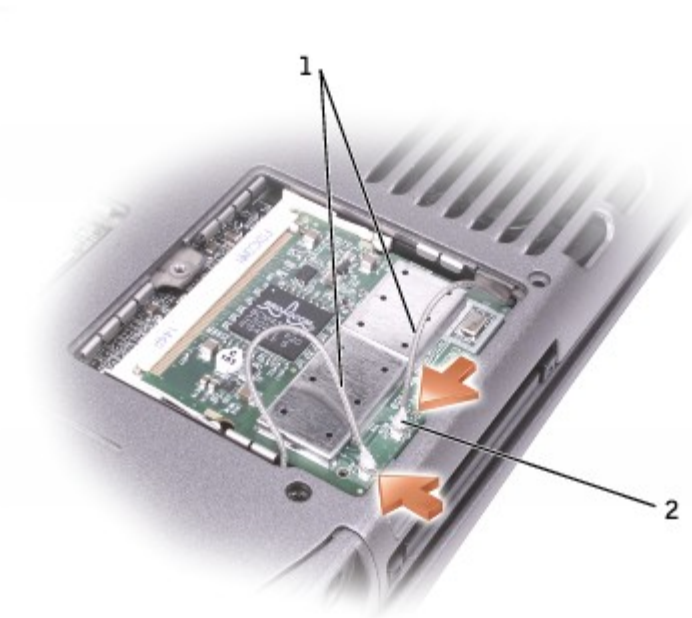

1	antenna connectors on card (2)
2	antenna cables (2)

6. Lower the Mini PCI card toward the inner tabs to approximately a 20-degree angle.
7. Continue lowering the Mini PCI card until it snaps into the inner tabs of the connector.
8. Replace the cover.

## Hard Drive

**NOTICE:** To prevent data loss, shut down your computer before removing the hard drive. Do not remove the hard drive while the computer is on, in [standby mode](#), or in [hibernate mode](#).

**NOTICE:** Hard drives are extremely fragile; even a slight bump can damage the drive.

**CAUTION:** If you remove the hard drive from the computer when the drive is hot, do not touch the metal housing of the hard drive.

**CAUTION:** Before working inside your computer, read the safety instructions in your *System Information Guide*.

**NOTE:** Dell does not guarantee compatibility or provide support for hard drives from sources other than Dell.

1. Turn the computer over. Use a small screwdriver to loosen the captive hard drive screw.



1	captive screws
---	----------------

2. Turn the computer over so that it is upright.

➡ **NOTICE:** You cannot remove your hard drive unless you open your display first.

3. Open the display approximately 2.54 cm (1 in).



➡ **NOTICE:** When the hard drive is not in the computer, store it in protective antistatic packaging. See "Protecting Against Electrostatic Discharge" in your *System Information Guide*."

4. Pull the hard drive cover out of the computer.

5. Remove the new drive from its packaging.

Save the original packaging for use when storing or shipping the hard drive.



 **NOTICE:** You cannot replace your hard drive unless you open your display first.

6. Ensure that the display is open approximately 2.54 cm (1 inch).

 **NOTICE:** Use firm and even pressure to slide the drive into place. If you force the hard drive into place using excessive force, you may damage the hard drive connector.

7. Press the hard drive cover into the bay until it is fully seated in the bay.

8. Turn the computer over. Use a small screwdriver to tighten the screw.

9. Use the *Operating System* CD to [install the operating system](#) for your computer.

10. Use the *Drivers and Utilities* CD to [install the drivers and utilities](#) for your computer.

---

## Connecting a Television to the Computer

Your computer has an S-video TV-out connector that enables you to connect the computer to a television. Using a commercially available S-video cable or composite video cable, you can connect the computer to a television in one of two ways:

- S-video (for a television with S-video input)
- Composite video (for a television with only a composite video input; also uses a composite TV-out adapter cable)

 **NOTE:** Diagrams for each connection combination appear at the beginning of each subsection to help you determine which method you should use.

The audio connector on the side of the computer enables you to connect the computer to your television or audio device, using a commercially available audio cable.

When you complete the cable connection, see "[Enabling the Display Settings for a Television](#)" to ensure that the computer recognizes and works properly with the television.

### S-Video Connection

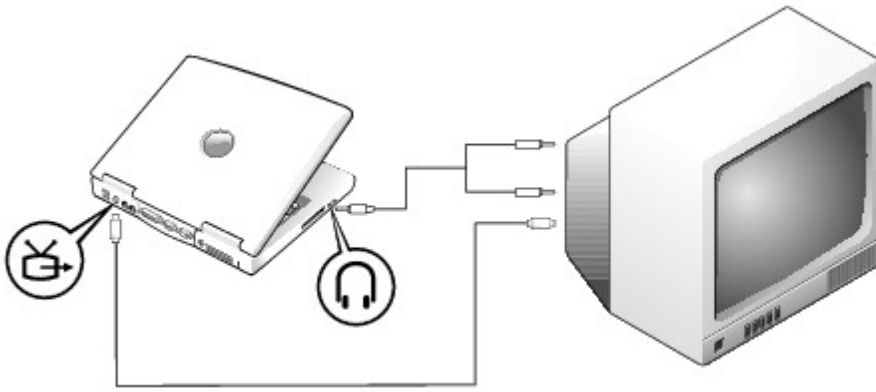

Before you begin, ensure that you have the following cables:

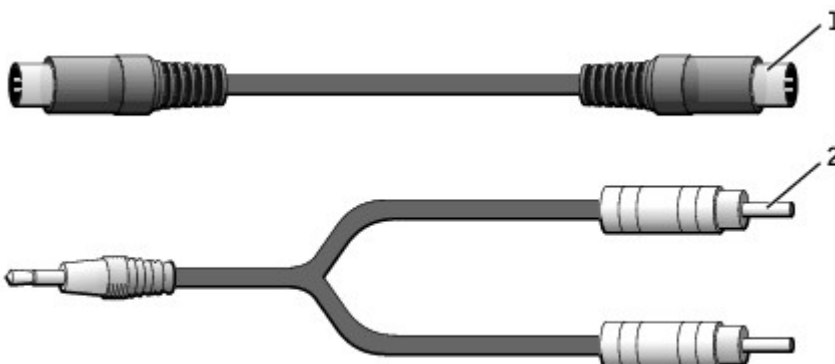

1	S-video cable
2	audio cable

1. Shut down the computer and the television and/or audio device you want to connect.
2. Plug one end of the S-video cable in to the S-video connector on the computer.

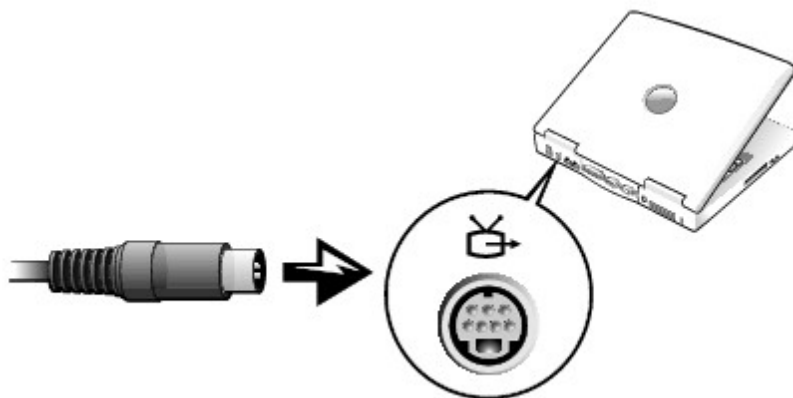

3. Plug the other end of the S-video cable in to your television.
4. Plug the single-connector end of the audio cable in to the headphone connector on your computer.

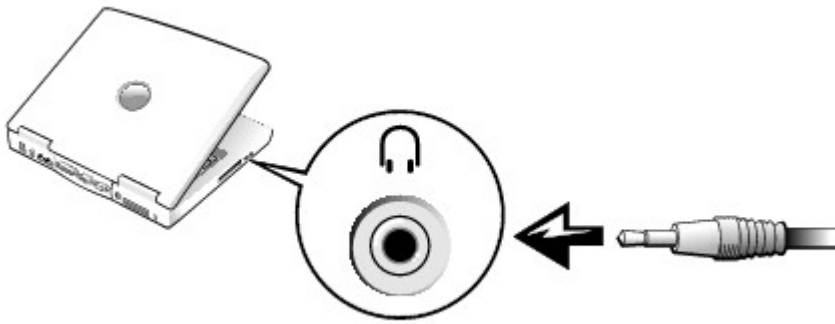

5. Plug the two RCA connectors on the other end of the audio cable in to the audio input connectors on your television or audio device.
6. Turn on the television, turn on any audio device you connected, and then turn on the computer.
7. See "[Enabling the Display Settings for a Television](#)" to ensure that the computer recognizes and works properly with the television.

## Composite Video Connection

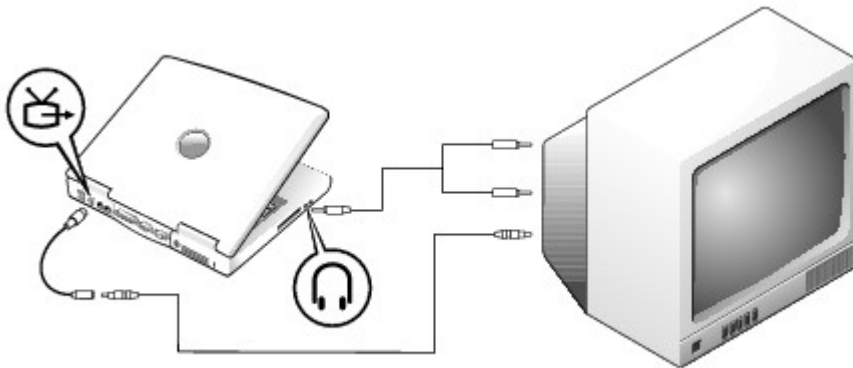

To connect the computer to a television that has a composite video input only, use a composite TV-out adapter cable available from Dell. Before you begin, ensure that you have the following cables:

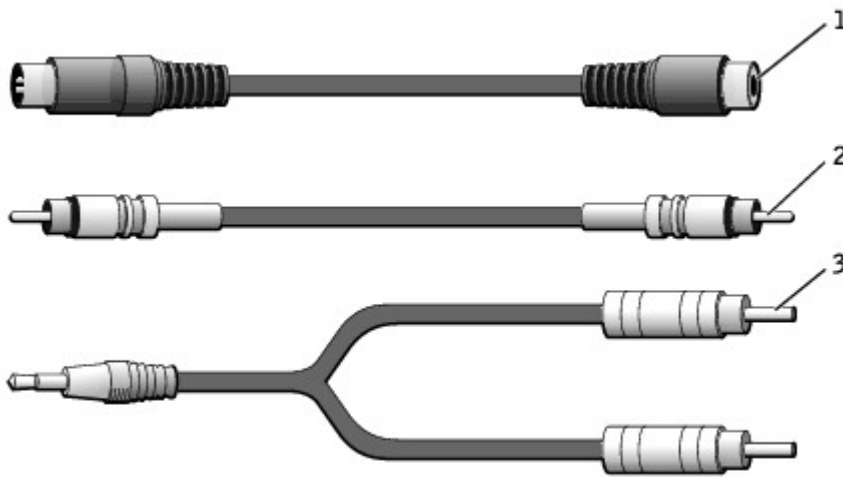

1	composite TV-out adapter cable
2	composite video cable
3	audio cable

1. Turn off the computer and the television and/or audio device you want to connect.
2. Connect the composite TV-out adapter cable to the S-video TV-out connector on the computer.

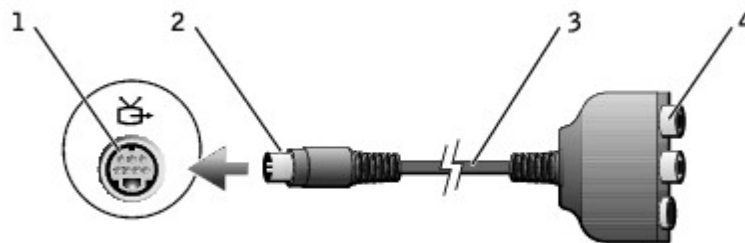

1	S-video TV-out connector
2	S-video connector
3	composite TV-out adapter cable
4	composite video connector

3. Plug one end of the composite video cable in to the composite video connector on the composite TV-out adapter cable.



4. Plug the other end of the composite video cable in to the composite video connector on the television.
5. Plug the single-connector end of the audio cable in to the headphone connector on the computer.

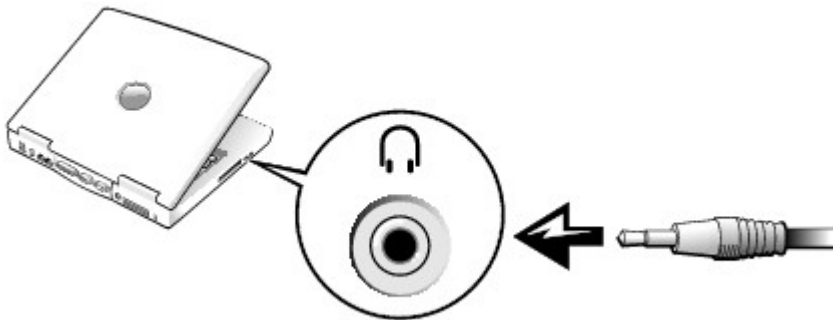

6. Plug the two RCA connectors on the other end of the audio cable in to the audio input connectors on your television or audio device.

## Enabling the Display Settings for a Television

### Intel UMA Integrated Video Controller

 **NOTE:** Ensure that you properly connect the television before you enable the display settings.

1. Open the **Control Panel** window.

*In Microsoft® Windows® XP,* click the **Start** button and click the **Control Panel** icon. Under **Pick a Category**, click **Appearance and Themes**.

*In Windows 2000,* click the **Start** button, point to **Settings**, and then click **Control Panel**.

2. Double-click the **Display** icon, click the **Settings** tab, and then click **Advanced**.
3. Click the **Intel (R) Extreme Graphics** tab.
4. Click the **Graphic Properties** button.
5. If you want to use only a television without using the computer display or any other display options:
  - a. In the new window, click **Television** so that a red check mark appears over the television icon.
  - b. Ensure that the settings are correct.

6. If you want to use a television and the computer display at the same time:
  - a. In the new window, click **Intel (R) Dual Display Clone** and ensure that one of the devices listed is a television.
  - b. Click **Device Settings**.
  - c. In the new window, ensure that the display resolution settings are correct.
7. Click **Apply** to view the new settings.

# Reinstalling Software

- [Reinstalling Drivers and Utilities](#)
  - [Resolving Software and Hardware Incompatibilities](#)
  - [Using Microsoft® Windows® System Restore](#)
  - [Reinstalling Windows® XP](#)
  - [Reinstalling Windows 2000](#)
- 

## Reinstalling Drivers and Utilities

Dell ships your computer to you with required drivers and utilities already installed—no further installation or configuration is needed.

- ➔ **NOTICE:** The *Drivers and Utilities* CD may contain drivers for operating systems that are not on your computer. Ensure that you are installing software appropriate for your operating system.

To reinstall drivers for optional devices such as wireless communications and DVD drives, you may need the CD and documentation that came with those devices.

- ➔ **NOTICE:** The Dell Support website, [support.dell.com](http://support.dell.com), and the *Drivers and Utilities* CD provide approved drivers for Dell™ computers. If you install drivers from other sources, your computer might not work correctly.

To reinstall a driver or utility from your *Drivers and Utilities* CD:

1. Save and close any open files, and exit any open programs.
2. Insert the *Drivers and Utilities* CD.

In most cases, the CD starts running automatically. If it does not, start Microsoft® Windows® Explorer, click your CD drive directory to display the CD contents, and then double-click the **autorcd.exe** file. The first time that you run the CD, it might prompt you to install setup files. Click **OK**, and follow the instructions on the screen to continue.

3. From the **Language** drop-down menu in the toolbar, select your preferred language for the driver or utility (if available).

A welcome screen appears.

4. Click **Next**. The CD automatically scans your hardware to detect drivers and utilities used by your computer.

After the CD completes the hardware scan, you can also detect other drivers and utilities. Under **Search Criteria**, select the appropriate categories from the **System Model**, **Operating System**, and **Topic**

drop-down menus.

A link or links appear(s) for the specific drivers and utilities used by your computer.

5. Click the link of a specific driver or utility to display information about the driver or utility that you want to install.
6. Click the **Install** button (if present) to begin installing the driver or utility. At the welcome screen, follow the screen prompts to complete the installation.

If no **Install** button is present, automatic installation is not an option. For installation instructions, either see the appropriate instructions in the following subsections, or click **Extract**, follow the extracting instructions, and read the readme file.

If instructed to navigate to the driver files, click the CD directory on the driver information window to display the files associated with that driver.

## Manually Reinstalling Drivers for Windows XP

 **NOTE:** If you are reinstalling an infrared-sensor driver, you must first enable the infrared sensor in the system setup program before continuing with the driver installation.

1. After extracting the driver files to your hard drive as described previously, click the **Start** button, point to **Settings**, and then click **Control Panel**. Click the **Start** button and right-click **My Computer**.
2. Click **Properties**.
3. Click the **Hardware** tab and click **Device Manager**.
4. Double-click the type of device for which you are installing the driver (for example, **Modems** or **Infrared devices**).
5. Double-click the name of the device for which you are installing the driver.
6. Click the **Driver** tab and click **Update Driver**.
7. Select **Install from a list or specific location (Advanced)** and click **Next**.
8. Click **Browse**, and browse to the location to which you previously extracted the driver files.
9. When the name of the appropriate driver appears, click **Next**.
10. Click **Finish** and restart your computer.

## Using the Windows XP Device Driver Rollback

If you install a new device driver that causes system instability, you can use the Windows XP Device Driver Rollback to replace the new device driver with the previously installed version of the device driver. If you cannot reinstall your previous driver by using the Device Driver Rollback process, then use [System Restore](#) to return your operating system to its previous operating state before you installed the new device driver. To use Device Driver Rollback:

1. Click the **Start** button and right-click **My Computer**.
2. Click **Properties**.
3. Click the **Hardware** tab and click **Device Manager**.



4. In the **Device Manager** window, right-click the device for which the new driver was installed and then click **Properties**.
5. Click the **Drivers** tab.
6. Click **Roll Back Driver**.

## Manually Reinstalling Drivers for Windows 2000



**NOTE:** If you are reinstalling an infrared driver, you must first enable the infrared sensor in the system setup program before continuing with the driver installation.

1. After extracting the driver files to your hard drive as described previously, click the **Start** button, point to **Settings**, and then click **Control Panel**.
2. Double-click the **System** icon.
3. Click the **Hardware** tab.
4. Click **Device Manager**.
5. Double-click the type of device for which you are installing the driver (for example, **Modems** or **Infrared devices**).
6. Double-click the name of the device.
7. Click the **Driver** tab and click **Update Driver**.
8. Click **Next**.
9. Ensure that **Search for a suitable driver for my device (recommended)** is selected, and then click **Next**.
10. Ensure that the **Specify a location** check box is checked and that all other check boxes are unchecked, and click **Next**.
11. Click **Browse** to browse to the location to which you previously extracted the driver files.
12. When the name of the appropriate driver appears, click **Next**.
13. Click **Finish** and restart your computer.

---

## Resolving Software and Hardware Incompatibilities

In the Microsoft® Windows® XP and Windows 2000 operating systems, IRQ conflicts occur if a device either is not detected during the operating system setup or is detected but incorrectly configured. See the following subsection that corresponds to your operating system to check for IRQ conflicts on your computer.

### Windows XP

1. Click the **Start** button and click **Control Panel**.
2. Click **Performance and Maintenance** and click **System**.

3. Click the **Hardware** tab and click **Device Manager**.
4. In the **Device Manager** list, check for conflicts with the other devices.

Conflicts are indicated by a yellow exclamation point (!) beside the conflicting device or a red X if the device has been disabled.

5. Double-click any conflicting device listed to bring up the **Properties** window so that you can determine what needs to be reconfigured or removed from the Device Manager.
6. Resolve these conflicts before checking specific devices.
7. Double-click the malfunctioning device type in the **Device Manager** list.
8. Double-click the icon for the specific device in the expanded list.

The **Properties** window appears.

If an IRQ conflict exists, the **Device status** area in the **Properties** window reports what other devices are sharing the device's IRQ.

9. Resolve any IRQ conflicts.

You can also use the Windows XP Hardware Troubleshooter. To use the troubleshooter, click the **Start** button and click **Help and Support**. Type `hardware troubleshooter` in the **Search** field, and then click the arrow to start the search. Click **Hardware Troubleshooter** in the **Search Results** list. In the **Hardware Troubleshooter** list, click **I need to resolve a hardware conflict on my computer** and click **Next**.

## Windows 2000

1. Click the **Start** button, point to **Settings**, and then click **Control Panel**.
2. Double-click the **System** icon.
3. Click the **Hardware** tab.
4. Click **Device Manager**.
5. Click **View** and click **Resources by connection**.
6. Double-click **Interrupt request (IRQ)** to view the IRQ assignments.

Conflicts are indicated by a yellow exclamation point (!) beside the conflicting device or a red X if the device has been disabled.

7. Double-click any conflicting device listed to bring up the **Properties** window so that you can determine what needs to be reconfigured or removed from the Device Manager. Resolve these conflicts before checking specific devices.
8. Double-click the malfunctioning device type in the **Device Manager** list.
9. Double-click the icon for the specific device in the expanded list.

The **Properties** window appears.

If an IRQ conflict exists, the **Device status** area in the **Properties** window reports what other devices are sharing the device's IRQ.

10. Resolve any IRQ conflicts.

You can also use the Windows 2000 Hardware Troubleshooter. To use the troubleshooter, click the **Start** button and click **Help**. Click **Troubleshooting and Maintenance** on the **Contents** tab, click **Windows 2000 troubleshooters**, and then click **Hardware**. In the **Hardware Troubleshooter** list, click **I need to resolve a hardware conflict on my computer**, and then click **Next**.

---

## Using Microsoft® Windows® System Restore

The Microsoft Windows XP operating system provides a System Restore feature that allows you to return your computer to an earlier operating state if changes to the computer's hardware, software (including new hardware or program installations), or system settings have left the computer in an undesirable operating state. You can also undo the last *system restore*.

System Restore automatically creates system checkpoints. You can also manually create your own checkpoints by creating *restore points*. To limit the amount of hard disk space used, older restore points will be automatically purged.

To resolve an operating system problem, you can use System Restore from Safe Mode or Normal Mode to return your computer to an earlier operating state.

System Restore does not cause you to lose personal files stored in the **My Documents** folder, data files, or e-mail messages after restoring the computer to an earlier time. If you restore the computer to an operating state that existed before you installed a program, the program's data files are not lost, but you must reinstall the actual program again.



**NOTICE:** It is important to make regular backups of your data files. System Restore does not monitor changes to or recover your data files. If the original data on the hard disk is accidentally erased or overwritten, or if it becomes inaccessible because of a hard disk malfunction, use your backup files to recover the lost or damaged data.

System Restore is enabled on your new computer. However, if you reinstall Windows XP with less than 200 MB of free hard-disk space available, System Restore is automatically disabled. Before you use System Restore, confirm that it is enabled:

1. Click the **Start** button and click **Control Panel**.
2. Click the **Performance and Maintenance**.
3. Click **System**.
4. Click the **System Restore** tab.
5. Ensure that **Turn off System Restore** is not checked.

## Creating a Restore Point

In Windows XP, you can either use the System Restore Wizard or manually create a restore point.

### Using the System Restore Wizard

To use the System Restore Wizard, click the **Start** button, click **Help and Support**, click **System Restore**,

and then follow the instructions in the **System Restore Wizard** window. You can also create and name a restore point if you are logged on as the computer administrator or a user with administrator rights.

## Manually Creating a Restore Point

1. Click the **Start** button, point to **All Programs**→**Accessories**→**System Tools**, and then click **System Restore**.
2. Click **Create a restore point**.
3. Click **Next**.
4. Type a name for the new restore point in the **Restore point description** field.

The present date and time are automatically added to the description of the new restore point.

5. Click **Create**.
6. Click **OK**.

## Restoring the Computer to an Earlier Operating State

If problems occur after installing a device driver, first try using [Device Driver Rollback](#). If Device Driver Rollback does not resolve the problem, then use System Restore.

 **NOTICE:** Before restoring the computer to an earlier operating state, save and close all open files and exit all open programs. Do not alter, open, or delete any files or programs until the system restoration is complete.

1. Click the **Start** button, point to **All Programs**→**Accessories**→**System Tools**, and then click **System Restore**.
2. Ensure that **Restore my computer to an earlier time** is selected and click **Next**.
3. Click a calendar date to which you want to restore your computer.

The **Select a Restore Point** screen provides a calendar that allows you to see and select restore points. All calendar dates with available restore points appear in bold.

4. Select a restore point and click **Next**.

If a calendar date has only one restore point, then that restore point is automatically selected. If two or more restore points are available, click the restore point that you want to use.

 **NOTICE:** Save and close all open files and exit all open programs. Do not alter, open, or delete any files or programs until the system restoration is complete.

5. Click **Next**.

In Windows XP, the **Restoration Complete** screen appears after System Restore finishes collecting data, and then the computer automatically restarts.

6. After the computer restarts, click **OK**.

To change the restore point, you can either repeat the steps using a different restore point, or you can undo the restoration.

## Undoing the Last System Restore

➡ **NOTICE:** Save and close all open files and exit all open programs. Do not alter, open, or delete any files or programs until the system restoration is complete.

1. Click the **Start** button, point to **All Programs**→**Accessories**→**System Tools**, and then click **System Restore**.
2. Select **Undo my last restoration** and click **Next**.

➡ **NOTICE:** Save and close all open files and exit all open programs. Do not alter, open, or delete any files or programs until the system restoration is complete.

3. Click **Next**.

The **System Restore** screen appears, and then the computer automatically restarts.

4. After the computer restarts, click **OK**.

---

## Reinstalling Windows® XP

Before reinstalling the Microsoft® Windows XP operating system to correct a problem, try correcting the problem by using Windows [System Restore](#).

➡ **NOTICE:** The *Operating System* CD provides options for reinstalling the Windows XP operating system. The options can potentially overwrite files installed by Dell and possibly affect programs installed on your hard drive. Therefore, do not reinstall your operating system unless instructed to do so by a Dell technical support representative.

1. Insert the *Operating System* CD.
2. Shut down the computer, and then turn on the computer.
3. Press any key when the `Press any key to boot from CD` message appears on the screen.
4. When the **Windows XP Setup** screen appears, press <Enter> to select **To set up Windows now**.
5. Read the information in the **License Agreement** window, and then press <F8> on your keyboard to agree with the license information.
6. If your computer already has Windows XP installed and you want to recover your current Windows XP data, type `r` to select the repair option, and then go to [step 15](#).

If you want to install a new copy of Windows XP, press <Esc> to select the fresh copy option and then press <Enter> on the next screen to select the highlighted partition (recommended). Then follow the instructions on the screen.

The **Windows XP Setup** screen appears and Windows XP begins to copy files and install the device

drivers. The computer automatically restarts multiple times before it requires additional input.

7. When the **Welcome to Microsoft** screen appears, click the green arrow icon at the bottom of the screen to continue. Then follow the instructions on the screen to finish the installation.
8. When the **Regional Settings** screen appears, select the settings for your locale and click **Next**.
9. Enter your name and organization in the **Personalize Your Software** screen and click **Next**.
10. *If you are reinstalling Windows XP Home Edition*, enter a name for your computer when the **Computer Name** window appear and click **Next**.

*If you are reinstalling Windows XP Professional*, enter a name for your computer and a password when the **Computer Name and Administrator Password** window appears and click **Next**.

11. If you have a modem installed, the **Modem Dialing Information** screen appears. Enter the requested information and click **Next**.
12. Enter the date, time, and time zone in the **Date and Time Settings** window and click **Next**.
13. If your computer has a network adapter, select the appropriate network settings. If your computer does not have a network adapter, you do not see this option.

Windows XP begins to install its components and configure the computer. The computer automatically restarts.

14. When the **Welcome to Microsoft** screen appears, click the green arrow icon at the bottom of the screen to continue. Then follow the instructions on the screen to complete the installation.
15. Remove the CD from the drive.
16. Reinstall the appropriate drivers.
17. Reinstall your virus protection software.

---

## Reinstalling Windows 2000



**NOTICE:** The *Operating System* CD provides options for reinstalling the Windows 2000 operating system. The options can potentially overwrite files installed by Dell and possibly affect programs installed on your hard drive. Therefore, do not reinstall your operating system unless instructed to do so by a Dell technical support representative.

1. Turn on the computer, and enter the system setup program as directed by a Dell technical support representative or as follows:
  - a. Shut down the computer.
  - b. Before the computer boots into Windows, press <F2> to enter the system setup program.
  - c. Press <Alt><P> to move to the **Boot** menu.
  - d. In the system setup program **Boot** menu, follow the instructions on the screen to change the boot sequence so that the CD or DVD drive boots first. Then insert the *Operating System* CD into the drive.

- e. Press <Esc> to save your changes and exit the system setup program.
  - f. Press any key to boot the computer from the CD.
2. When the **Windows 2000 Setup** window appears, ensure that **To setup Win2000 now, press ENTER** is highlighted. Then press <Enter>.
  3. Read the information in the **License Agreement** window and press <F8> to continue.
  4. When the **Windows 2000 Professional Setup** window appears, press the arrow keys to select the Windows 2000 partition option that you want. Then press the key for the partition option you chose.
  5. When the **Windows 2000 Professional Setup** window reappears, press the arrow keys to select the type of file system that you want Windows 2000 to use, and then press <Enter>.
  6. Press <Enter> again to restart your computer.
  7. Click **Next** when the **Welcome to the Windows 2000 Setup Wizard** window appears.
  8. When the **Regional Settings** window appears, select your region, and then click **Next**.
  9. Enter your name and organization in the **Personalize Your Software** window and click **Next**.
  10. Enter the Windows product key, which is printed on the Microsoft label on your computer. Then click **Next**.
  11. When the **Computer Name and Administrator Password** window appears, enter a name for your computer and a password, if desired. Then click **Next**.
  12. Enter the date and time in the **Date and Time Settings** window and click **Next**.

Windows 2000 installs components and configures the computer.

13. When the **Completing the Windows 2000 Setup Wizard** window appears, remove the CD from the drive and click **Finish**.

The computer automatically restarts.

## Enabling Hibernate Mode

1. Click the **Start** button, point to **Settings** and click **Control Panel**.
2. Double-click the **Power Management** icon.
3. Click the **Hibernate** tab.
4. Ensure that **Enable hibernate support** is selected and click **Apply**.
5. Click **OK** to close the Control Panel.

# Cleaning Your Computer

- [Computer and Keyboard](#)
  - [Display](#)
  - [Touch Pad](#)
  - [Floppy Drive](#)
  - [Optical Media](#)
- 

## Computer and Keyboard

1. Shut down your computer, disconnect any attached devices, and disconnect them from their electrical outlets.
2. [Remove any installed batteries.](#)
3. Gently use a vacuum cleaner with a brush attachment to remove dust from the slots and holes on your computer and between the keys on the keyboard.

 **NOTICE:** To avoid damaging the computer or display, do not spray cleaning solution directly onto the display. Only use products specifically designed for cleaning LCDs, and follow the instructions that are included with the product.

4. Moisten a soft, lint-free cloth with water or an LCD cleaner, and wipe the computer and keyboard. Do not allow water from the cloth to seep between the touch pad and the surrounding palm rest.
- 

## Display

 **NOTICE:** To avoid damaging the computer or display, do not spray cleaning solution directly onto the display. Only use products specifically designed for cleaning LCDs, and follow the instructions that are included with the product.

1. Shut down your computer, disconnect any attached devices, and disconnect them from their electrical outlets.
  2. [Remove any installed batteries.](#)
  3. Moisten a soft, lint-free cloth with water or an LCD cleaner, and wipe the display until it is clean.
-



## Touch Pad

1. Shut down your computer, disconnect any attached devices, and disconnect them from their electrical outlets.
  2. [Remove any installed batteries.](#)
  3. Moisten a soft, lint-free cloth with water, and stroke it gently across the surface of the touch pad. Do not allow water from the cloth to seep between the touch pad and the surrounding palm rest.
- 

## Floppy Drive

Use only a commercially available cleaning kit to clean your floppy drive. Such kits contain pretreated floppy disks to remove contaminants that accumulate during typical operation.

---

## Optical Media

-  **NOTICE:** Always use compressed air to clean the lens in the drive, and follow the instructions that are included with the compressed air. Never touch the lens in the drive.

If you notice problems, such as skipping, with the playback quality of your CDs or DVDs, try cleaning the discs.

1. Hold the disc by its outer edge. You can also touch the inside edge of the center hole.

-  **NOTICE:** To avoid damaging the surface, do not wipe in a circular motion around the disc.

2. With a soft, dry, lint-free cloth, gently wipe the bottom of the disc (the unlabeled side) in a straight line from the center to the outer edge.

You can also purchase commercial products that clean discs and provide some protection from dust, fingerprints, and scratches. Cleaning products for CDs are safe to use on DVDs.

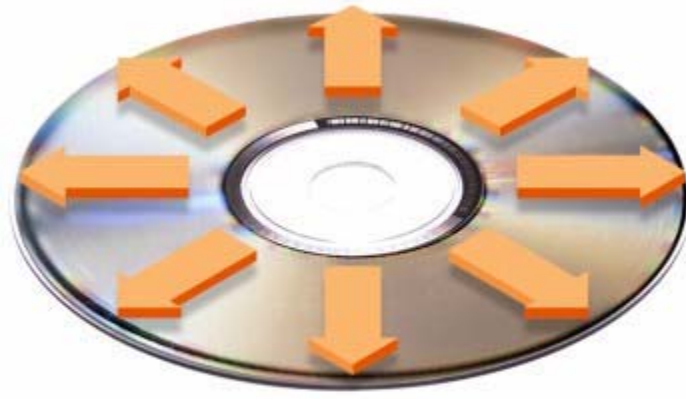

# Using the Dell Diagnostics

- [When to Use the Dell Diagnostics](#)
  - [Features of the Dell Diagnostics](#)
  - [Starting the Dell Diagnostics](#)
- 

## When to Use the Dell Diagnostics

Whenever a major component or device in your computer does not function properly, you may have a component failure. If you are experiencing a problem with your Dell™ computer, perform the checks in "[Solving Problems](#)" and run the Dell Diagnostics *before* you call Dell for technical assistance. Running the Dell Diagnostics may help you to resolve the problem yourself quickly without having to contact Dell for assistance.

If you are experienced with computers and know what component(s) you need to test, select the appropriate diagnostic test group(s) or subtest(s). If you are unsure about how to begin diagnosing a problem, see "[Starting the Dell Diagnostics](#)."

---

## Features of the Dell Diagnostics

The Dell Diagnostics helps you to check your computer hardware without any additional equipment and without destroying any data. By using the diagnostics, you can have confidence in the operation of your computer. If you find a problem that you cannot solve by yourself, the diagnostic tests can provide you with important information you need when talking to Dell's service and support personnel.

- **NOTICE:** Use the Dell Diagnostics to test only your Dell computer. Using this program with other computers may cause incorrect computer responses or result in error messages.

The diagnostic test groups or subtests also have the following features:

- Options that let you perform express, extended, or custom tests on one or all devices
- An option that allows you to select tests based on a symptom of the problem you are having
- An option that allows you to choose the number of times a test group or subtest is repeated
- The ability to display test results
- Options to temporarily suspend testing if an error is detected, or to terminate testing
- Extensive online Help that describes the tests and devices
- Status messages that inform you whether test groups or subtests were completed successfully
- Error messages that appear if any problems are detected

## Starting the Dell Diagnostics

The Dell Diagnostics is located on a hidden Diagnostic utility partition on your hard drive.

 **NOTE:** If your computer cannot display a screen image, [contact Dell](#).

1. Shut down the computer.
2. If the computer is connected to a docking device (docked), undock it. See the documentation that came with your docking device for instructions.
3. Connect the computer to an electrical outlet.

 **NOTE:** If you cannot see anything on your display, you can hold down the mute button and press the power button (instead of F12) to begin the Dell Diagnostics. You do not need to highlight **Diagnostics** and press <Enter>. The computer automatically runs the Pre-boot System Assessment.

4. Turn on the computer. When the DELL™ logo appears, press <F12> immediately. If you wait too long and the Microsoft® Windows® logo appears, continue to wait until you see the Windows desktop. Then shut down your computer and try again.
5. When the boot device list appears, highlight **Diagnostics** and press <Enter>.

The computer begins to run the Pre-boot System Assessment, a series of embedded diagnostics that perform initial testing on your system board, keyboard, hard drive, and display.

- During the assessment, answer any questions that appear.
- If a component failure is detected, the computer stops and beeps. To stop the assessment and reboot to the operating system, press <N>; to continue to the next test, press <Y>; to retest the component that failed, press <R>.
- If failures are detected during the Pre-boot System Assessment, write down the error code(s) and [contact Dell](#) before continuing on to the Dell Diagnostics.
- If you receive a message stating that no Diagnostics utility partition has been found, follow the instructions on the screen to run the Dell Diagnostics from your *Drivers and Utilities* CD.

If the Pre-boot System Assessment completes successfully, you receive the message `Booting Dell Diagnostic Utility Partition. Press any key to continue.`

6. Press any key to start the Dell Diagnostics from the Diagnostics utility partition on your hard drive.
7. After the Dell Diagnostics loads and the **Main Menu** screen appears, click the button for the option you want.

 **NOTE:** The Service Tag for your computer is located in the title bar of each screen.

Option	Function
<b>Express Test</b>	<b>Performs a quick test of devices. The test typically takes 10 to 20 minutes and requires no interaction on your part. Run Express Test first to increase the</b>

	<b>possibility of tracing the problem quickly.</b>
<b>Extended Test</b>	<b>Performs a thorough check of devices. The test typically takes 1 hour or more and requires you to answer questions periodically.</b>
<b>Custom Test</b>	<b>Tests a specific device. You can customize the tests to be run.</b>
<b>Symptom Tree</b>	<b>Allows you to select tests based on a symptom of the problem you are experiencing. The option lists the most common symptoms.</b>

8. If a problem is encountered during a test, a message appears, displaying the error code and a description of the problem. Write down the error code and problem description and follow the instructions on the screen. If you cannot resolve the error condition, [contact Dell](#).
9. If you run a test from the **Custom Test** or **Symptom Tree** option, click the applicable tab described in the following table for more information.

<b>Tab</b>	<b>Function</b>
Results	Displays the results of the test and any error conditions encountered.
Errors	Displays error conditions encountered, error codes, and problem description.
Help	Describes the test and may indicate requirements for running the test.
Configuration	Displays your hardware configuration for the selected device.  The Dell Diagnostics obtains your configuration information for all devices from the <a href="#">system setup program</a> , memory, and various internal tests and displays the information in the device list in the left pane of the screen. The device list may not display the names of all the components installed on your computer or all devices attached to your computer.
Parameters	Allows you to customize the test by changing the test settings.

10. When you have finished running a test, close the screen to return to the **Main Menu** screen. To exit the Dell Diagnostics and reboot the computer, close the **Main Menu** screen.

# Solving Problems

- [Power Problems](#)
  - [Error Messages](#)
  - [Video and Display Problems](#)
  - [Sound and Speaker Problems](#)
  - [Printer Problems](#)
  - [Modem and Internet Connection Problems](#)
  - [Touch Pad or Mouse Problems](#)
  - [External Keyboard Problems](#)
  - [Unexpected Characters](#)
  - [Drive Problems](#)
  - [PC Card Problems](#)
  - [Network Problems](#)
  - [General Program Problems](#)
  - [If Your Dell™ Computer Gets Wet](#)
  - [If You Drop or Damage Your Computer](#)
  - [Resolving Other Technical Problems](#)
- 

## Power Problems

Fill out the [Diagnostics Checklist](#) as you complete these checks.

**Check the power light** — When the power light is lit or blinking, the computer has power. If the power light is blinking, the computer is in standby mode—press the power button to exit [standby mode](#). If the light is off, press the power button to turn on the computer.

**Charge the battery** — The battery charge may be depleted.

1. Reinstall the battery.
2. Use the AC adapter to connect the computer to an electrical outlet.
3. Turn on the computer.

**Check the battery status light** — If the battery status light flashes orange or is a steady

orange the battery charge is low or depleted. Connect the computer to an electrical outlet.

If the battery status light flashes green and orange, the battery is too hot to charge. Shut down the computer, disconnect the computer from the electrical outlet, and then let the battery and computer cool to room temperature.

If the battery status light rapidly flashes orange, the battery may be defective. [Contact Dell](#).

**Test the electrical outlet** — Ensure that the electrical outlet is working by testing it with another device, such as a lamp.

**Check the AC adapter** — Check the AC adapter cable connections. If the AC adapter has a light, ensure that the light is on.

**Connect the computer directly to an electrical outlet** — Bypass power protection devices, power strips, and the extension cable to verify that the computer turns on.

**Eliminate possible interference** — Turn off nearby fans, fluorescent lights, halogen lamps, or other appliances.

**Adjust the power properties** — See "[Power Management](#)."

**Reseat the memory modules** — If the computer power light turns on but the display remains blank, [reseat the memory modules](#).

## Error Messages

If the message is not listed, see the documentation for the operating system or the program that was running at the time the message appeared.

**Auxiliary device failure** — The touch pad or external mouse may be faulty. For an external mouse, check the cable connection. Enable the Pointing Device option in the system setup program. If the problem persists, [contact Dell](#).

**Bad command or file name** — Ensure that you have spelled the command correctly, put spaces in the proper place, and used the correct pathname.

**Cache disabled due to failure** — The primary cache internal to the microprocessor has failed. [Contact Dell](#).

**CD drive controller failure** — The CD drive does not respond to commands from the computer. See "[Drive Problems](#)."

**Data error** — The floppy or hard drive cannot read the data. See "[Drive Problems](#)."

**Decreasing available memory** — One or more memory modules may be faulty or improperly seated. Reseat the memory modules and, if necessary, replace them. See "[Memory](#)."

**Disk C: failed initialization** — The hard drive failed initialization. Run the Hard-Disk Drive tests as described in "[Using the Dell Diagnostics](#)."

**Floppy drive 0 seek failure** — The system configuration information may not match the hardware configuration. Run the Diskette tests as described in "[Using the Dell Diagnostics](#)."

**Diskette read failure** — The floppy disk may be defective. If the drive access light turns on, try a different disk. See "[Drive Problems](#)."

**Diskette subsystem reset failed** — The floppy drive controller may be faulty. Run the

<b>Diskette tests as described in "<a href="#">Using the Dell Diagnostics</a>."</b>
<b>Diskette write-protected</b> — Because the floppy disk is write-protected, the operation cannot be completed. Slide the write-protect notch.
<b>Drive not ready</b> — The operation requires a floppy disk in the drive or a hard drive in the bay before it can continue. Insert a floppy disk, or push the floppy disk all the way into the drive until the eject button pops out. Or, <a href="#">install a hard drive</a> in the hard drive bay.
<b>Error reading PCMCIA card</b> — The computer cannot identify the PC Card. Reinsert the card or try another PC Card.
<b>Extended memory size has changed</b> — The amount of memory recorded in NVRAM does not match the memory installed in the computer. Restart the computer. If the error appears again, <a href="#">contact Dell</a> .
<b>Gate A20 failure</b> — A memory module may be loose. <a href="#">Reinstall the memory modules</a> and, if necessary, replace them.
<b>General failure</b> — The operating system is unable to carry out the command. The message is usually followed by specific information—for example, <i>Printer out of paper</i> . Take the appropriate action.
<b>Hard-disk drive configuration error</b> — The computer cannot identify the drive type. Turn off the computer, <a href="#">remove the hard drive</a> , and boot the computer from a bootable floppy disk or CD. Then turn off the computer, reinstall the hard drive, and restart the computer. Run the Hard-Disk Drive tests as described in " <a href="#">Using the Dell Diagnostics</a> ."
<b>Hard-disk drive controller failure 0</b> — The hard drive does not respond to commands from the computer. Turn off the computer, <a href="#">remove the hard drive</a> , and boot the computer from a bootable floppy disk or CD. Then turn off the computer, reinstall the hard drive, and restart the computer. If the problem persists, try another drive. Run the Hard-Disk Drive tests as described in " <a href="#">Using the Dell Diagnostics</a> ."
<b>Hard-disk drive failure</b> — The hard drive does not respond to commands from the computer. Turn off the computer, <a href="#">remove the hard drive</a> , and boot the computer from a bootable floppy disk or CD. Then turn off the computer, reinstall the hard drive, and restart the computer. If the problem persists, try another drive. Run the Hard-Disk Drive tests as described in " <a href="#">Using the Dell Diagnostics</a> ."
<b>Hard-disk drive read failure</b> — The hard drive may be defective. Turn off the computer, <a href="#">remove the hard drive</a> , and boot the computer from a bootable floppy disk or CD. Then turn off the computer, reinstall the hard drive, and restart the computer. If the problem persists, try another drive. Run the Hard-Disk Drive tests as described in " <a href="#">Using the Dell Diagnostics</a> ."
<b>Insert bootable media</b> — The operating system is trying to boot to a nonbootable floppy disk or CD. Insert a bootable floppy disk or CD.
<b>Invalid configuration information-please run System Setup Program</b> — The system configuration information does not match the hardware configuration. The message is most likely to occur after a memory module is installed. Correct the appropriate options in the system setup program. See " <a href="#">Using the System Setup Program</a> ."
<b>Keyboard clock line failure</b> — For external keyboards, check the cable connection. Run the Keyboard Controller test as described in " <a href="#">Using the Dell Diagnostics</a> ."
<b>Keyboard controller failure</b> — For external keyboards, check the cable connection. Restart the computer, and avoid touching the keyboard or the mouse during the boot routine. Run the Keyboard Controller test as described in " <a href="#">Using the Dell Diagnostics</a> ."
<b>Keyboard data line failure</b> — For external keyboards, check the cable connection. Run the Keyboard Controller test as described in " <a href="#">Using the Dell Diagnostics</a> ."
<b>Keyboard stuck key failure</b> — For external keyboards or keypads, check the cable



connection. Restart the computer, and avoid touching the keyboard or keys during the boot routine. Run the Stuck Key test as described in "[Using the Dell Diagnostics.](#)"

**Memory address line failure at address, read value expecting value** — A memory module may be faulty or improperly seated. [Reinstall the memory modules](#) and, if necessary, replace them.

**Memory allocation error** — The software you are attempting to run is conflicting with the operating system, another program, or a utility. Turn off the computer, wait 30 seconds, and then restart it. Try to run the program again. If the error message still appears, see the software documentation.

**Memory data line failure at address, read value expecting value** — A memory module may be faulty or improperly seated. [Reinstall the memory modules](#) and, if necessary, replace them.

**Memory double word logic failure at address, read value expecting value** — A memory module may be faulty or improperly seated. [Reinstall the memory modules](#) and, if necessary, replace them.

**Memory odd/even logic failure at address, read value expecting value** — A memory module may be faulty or improperly seated. [Reinstall the memory modules](#) and, if necessary, replace them.

**Memory write/read failure at address, read value expecting value** — A memory module may be faulty or improperly seated. [Reinstall the memory modules](#) and, if necessary, replace them.

**No boot device available** — The computer cannot find the floppy disk or hard drive. If the floppy drive is your boot device, ensure that a bootable floppy disk is in the drive. If the hard drive is your boot device, ensure that the drive is installed, properly seated, and partitioned as a boot device.

**No boot sector on hard drive** — The operating system may be corrupted. [Contact Dell.](#)

**No timer tick interrupt** — A chip on the system board may be malfunctioning. Run the System Set tests as described in "[Using the Dell Diagnostics.](#)"

**Non-system disk or disk error** — A floppy disk is in the floppy drive. Remove the floppy disk and restart the computer.

**Not a boot diskette** — The operating system is trying to boot to a nonbootable floppy disk. Insert a bootable floppy disk.

**Operating system not found** — [Contact Dell.](#)

**Optional ROM bad checksum** — The optional ROM apparently failed. [Contact Dell.](#)

**A required .DLL file was not found** — The program that you are trying to open is missing an essential file. Remove and then reinstall the program.

#### **Microsoft® Windows® XP**

1. Click the Start button and click Control Panel.
2. Click Add or Remove Programs.
3. Select the program you want to remove.
4. Click Remove or Change/Remove and follow the prompts on the screen.
5. See the program documentation for installation instructions.

#### **Windows 2000**

1. Click the Start button, point to Settings, and then click Control Panel.
2. Double-click the Add/Remove Programs icon.
3. Select the program that you want to remove.

4. Click Change or Remove Programs.
5. See the program documentation for installation instructions.

**Sector not found** — The operating system cannot locate a sector on the floppy or hard drive. You may have a defective sector or corrupted FAT on the floppy disk or hard drive. Run the Windows error-checking utility to check the file structure on the floppy disk or hard drive. See *Windows Help* for instructions. If a large number of sectors are defective, back up the data (if possible), and then reformat the floppy disk or hard drive.

**Seek error** — The operating system cannot find a specific track on the floppy disk or hard drive. If the error is on the floppy disk, try another floppy disk.

**Shutdown failure** — A chip on the system board may be malfunctioning. Run the System Set tests as described in "[Using the Dell Diagnostics](#)."

**Time-of-day clock lost power** — System configuration settings are corrupted. Connect your computer to an electrical outlet to charge the battery. If the problem persists, try to restore the data by entering the system setup program. Then immediately exit the program. See "[Using the System Setup Program](#)." If the message reappears, [contact Dell](#).

**Time-of-day clock stopped** — The reserve battery that supports the system configuration settings may require recharging. Connect your computer to an electrical outlet to charge the battery. If the problem persists, [contact Dell](#).

**Time-of-day not set-please run the System Setup program** — The time or date stored in the system setup program does not match the system clock. Correct the settings for the Date and Time options. See "[Using the System Setup Program](#)."

**Timer chip counter 2 failed** — A chip on the system board may be malfunctioning. Run the System Set tests as described in "[Using the Dell Diagnostics](#)."

**Unexpected interrupt in protected mode** — The keyboard controller may be malfunctioning, or a memory module may be loose. Run the System Memory tests and the Keyboard Controller test as described in "[Using the Dell Diagnostics](#)."

**x:\ is not accessible. The device is not ready** — Insert a disk into the drive and try again.

**Warning: Battery is critically low** — The [battery is running out of charge](#). Replace the battery, or connect the computer to an electrical outlet. Otherwise, activate [hibernate mode](#) or turn off the computer.

## Video and Display Problems

Fill out the [Diagnostics Checklist](#) as you complete these checks.

### If the display is blank

 **NOTE:** If you are using a program that requires a higher resolution than your computer supports, it is recommended that you attach an external monitor to your computer.

**Check the battery** — If you are using a battery to power your computer, the battery charge may be depleted. Connect the computer to an electrical outlet using the AC adapter, and turn on the computer.

**Test the electrical outlet** — Ensure that the electrical outlet is working by testing it with another device, such as a lamp.

**Check the AC adapter** — Check the AC adapter cable connections. If the AC adapter has a light, ensure that the light is on.

**Connect the computer directly to an electrical outlet** — Bypass power protection devices, power strips, and the extension cable to verify that the computer turns on.

**Adjust the power properties** — Search for the keyword *standby* in *Windows Help* or the *Windows Help and Support Center*.

**Switch the video image** — If your computer is attached to an external monitor, press <Fn><F8> to switch the video image to the display.

## If the display is difficult to read

**Adjust the brightness** — See "[Adjusting Brightness](#)" for instructions on adjusting the brightness.

**Move the subwoofer away from the computer or monitor** — If your external speaker system includes a subwoofer, ensure that the subwoofer is at least 60 cm (2 ft) away from the computer or external monitor.

**Eliminate possible interference** — Turn off nearby fans, fluorescent lights, halogen lamps, or other appliances.

**Rotate the computer to face a different direction** — Eliminate sunlight glare, which can cause poor picture quality.

### Adjust the Windows display settings —

#### *Windows XP*

1. Click the **Start** button and then click **Control Panel**.
2. Click **Appearance and Themes**.
3. Click the area you want to change or click the **Display** icon.
4. Try different settings for **Color quality** and **Screen resolution**.

#### *Windows 2000*

1. Click the **Start** button, point to **Settings**, and then click **Control Panel**.
2. Double-click the **Display** icon and click the **Settings** tab.
3. Try different settings for **Colors**, **Screen area**, and **Advanced Settings**.

**Run the Video diagnostics tests** — If no error message appears and you still have a display problem, but the display is not completely blank, run the **Video** device group in the [Dell Diagnostics](#). Then [contact Dell](#).

**See "Error Messages"** — If an error message appears, see "[Error Messages](#)."

## If only part of the display is readable

### Connect an external monitor —

1. Shut down your computer and connect an external monitor to the computer.
2. Turn on the computer and the monitor and adjust the monitor brightness and contrast controls.

If the external monitor works, the computer display or video controller may be defective. [Contact Dell.](#)

---

## Sound and Speaker Problems

Fill out the [Diagnostics Checklist](#) as you complete these checks.

### If you have a problem with integrated speakers

**Adjust the Windows volume control** — Double-click the speaker icon in the lower-right corner of your screen. Ensure that the volume is turned up and that the sound is not muted. Adjust the volume, bass, or treble controls to eliminate distortion.

**Adjust the volume using keyboard shortcuts** — See "[Using the Keyboard and Touch Pad.](#)" Press <Fn><End> to disable (mute) or reenable the integrated speakers.

**Reinstall the sound (audio) driver** — See "[Reinstalling Software.](#)"

**For Windows 2000 only, ensure that digital audio for the CD drive is enabled** —

1. Click the **Start** button, point to **Settings**, and then click **Control Panel**.
2. Double-click the **System** icon.
3. Click the **Hardware** tab.
4. Click **Device Manager**.
5. Double-click **DVD/CD-ROM drives**.
6. Double-click the name of the drive.
7. On the drive **Properties** screen, click the **Properties** tab.
8. Click the box near the bottom of the screen to enable digital audio for your CD or DVD drive.

### If you have a problem with external speakers

 **NOTE:** The volume control in some MP3 players overrides the Windows volume setting. If you have been listening to MP3 songs, make sure that you did not turn the player volume down or off.

**Check the speaker cable connections** — See the setup diagram supplied with the speakers.

**Test the electrical outlet** — Ensure that the electrical outlet is working by testing it with another device, such as a lamp.

**Ensure that the speakers are turned on** — See the setup diagram supplied with the speakers.

**Adjust the Windows volume control** — Double-click the speaker icon in the lower-right corner of your screen. Ensure that the volume is turned up and that the sound is not muted. Adjust the volume, bass, or treble controls to eliminate distortion.

**Test the speakers** — Plug the speaker audio cable in to the  connector on the computer. Ensure that the headphone volume control is turned up. Play a music CD.

**Run the speaker self-test** — Some speaker systems have a self-test button on the subwoofer. See the speaker documentation for self-test instructions.

**Eliminate possible interference** — Turn off nearby fans, fluorescent lights, or halogen lamps to check for interference.

**Reinstall the sound (audio) driver** — See "[Reinstalling Software](#)."

**Run the Misc. PCI Devices diagnostic test** — See "[Using the Dell Diagnostics](#)." If the tests complete successfully, the controller is functioning properly.

If the problem persists, or if the tests do not complete successfully, [contact Dell](#).

**For Windows 2000 only, ensure that digital audio for the CD drive is enabled** —

1. Click the **Start** button, point to **Settings**, and then click **Control Panel**.
2. Double-click the **System** icon.
3. Click the **Hardware** tab.
4. Click **Device Manager**.
5. Double-click **DVD/CD-ROM drives**.
6. Double-click the name of the drive.
7. On the drive **Properties** screen, click the **Properties** tab.
8. Click the box near the bottom of the screen to enable digital audio for your CD or DVD drive.

---

## Printer Problems

Fill out the [Diagnostics Checklist](#) as you perform the various checks.

**Check the printer cable connections** — Ensure that the printer cable is properly connected to the computer.

**Check the printer cable** —

1. Shut down the computer and turn off the printer.
2. Swap the printer cable with a cable that you know is working.
3. Turn on the printer and computer, and try again to print.
4. If you print successfully, [contact Dell](#) for assistance in obtaining a new printer cable.

**Test the electrical outlet** — Ensure that the electrical outlet is working by testing it with another device, such as a lamp.

**Ensure that the printer is turned on** — See the documentation supplied with the printer.

**Verify that Windows recognizes the printer** —

*Windows XP*

1. Click the **Start** button and click **Control Panel**.
2. Click **Printers and Other Hardware**.
3. Click **View installed printers or fax printers**. If the printer model is listed, right-click the printer icon.
4. Click **Properties** and click the **Ports** tab. Ensure that the **Print to the following port (s)**: setting is **LPT1 (Printer Port)**.

*Windows 2000*

1. Click the **Start** button, point to **Settings**, and then click **Printers**.



If the printer model is listed, right-click the printer icon.

2. Click **Properties** and click the **Ports** tab.
3. Ensure that the **Print to the following port:** option is set for your printer type:
  - For a parallel printer: **LPT1 (Printer Port)**
  - For a USB printer: **USB**

**Reinstall the printer driver** — See "[Reinstalling Software](#)."

**Check the printer** — Run the printer self-test. If the test does not complete successfully, the printer is probably defective. Contact the printer manufacturer.

## Modem and Internet Connection Problems

-  **NOTICE:** Connect the modem to an analog telephone wall jack only. Connecting the modem to a digital telephone network may damage the modem.
-  **NOTICE:** Modem and network connectors look similar. Do not plug a telephone line in to the network connector.

Fill out the [Diagnostics Checklist](#) as you complete these checks.

-  **NOTE:** If you can connect to your Internet service provider (ISP), your modem is functioning properly. If you are sure that your modem is working properly and you still experience problems, contact your ISP.

**Check the telephone wall jack** — Disconnect the telephone line from the modem and connect it to a telephone. Listen for a dial tone. Ensure that you have touchtone telephone service. Try connecting the modem to a different telephone wall jack.

Slow connection speeds can be caused by telephone noise as well as by telephone line or network conditions. Contact your telephone company or network administrator for more information.

**Connect the modem directly to the telephone wall jack** — If you have other telephone devices sharing the line, such as an answering machine, fax machine, surge protector, or line splitter, then bypass them and use the telephone line to connect the modem directly to the telephone wall jack.

**Check the connection** — Verify that the telephone line is connected to the modem.

**Check the telephone line** — Try using a different telephone line. If you are using a line that is 3 m (10 ft) or more in length, try a shorter one.

**Irregular dial tone** — If you have voice mail service, you might hear an irregular dial tone when you have messages. Contact your telephone company for instructions on restoring a dial tone.

**Turn off call waiting (catch-phone)** — See your telephone directory for instructions on deactivating this feature. Then adjust the dial-up networking connection properties.

*Windows XP*

1. Click the **Start** button and click **Control Panel**.
2. Click **Printers and Other Hardware**, click **Phone and Modem Options**, click the **Dialing Rules** tab, and then click **Edit...**
3. In the **Edit Location** window, ensure that **To disable call waiting, dial:** is checked, and

then select the proper code as listed in your telephone directory.

4. Click **Apply** and click **OK**.
5. Close the **Phone and Modems Options** window.
6. Close the **Control Panel** window.

#### *Windows 2000*

1. Click the **Start** button, point to **Settings**, and then click **Control Panel**.
2. Click **Phone and Modem Options**.
3. Click the **Dialing Rules** tab and click **Edit**.
4. Ensure that **To disable call waiting, dial:** is checked, and then select the proper code as listed in your telephone directory.
5. Click **Apply** and click **OK**.
6. Close the **Phone and Modem Options** window.

#### **Verify that the modem is communicating with Windows —**

##### *Windows XP*

1. Click the **Start** button and click **Control Panel**.
2. Click **Printers and Other Hardware** and click **Phone and Modem Options**.
3. Click the **Modems** tab.
4. Click the COM port for your modem.
5. Click **Properties**, click the **Diagnostics** tab, and then click **Query Modem** to verify that the modem is communicating with Windows.

If all commands receive responses, the modem is operating properly.

##### *Windows 2000*

1. Click the **Start** button, point to **Settings**, and then click **Control Panel**.
2. Double-click **Phone and Modem Options**.

If multiple entries for the same modem or modems are listed but not installed, delete the entries, restart the computer, and repeat steps 1 and 2.

3. Click the **Diagnostics** tab.
4. Click the COM port for your modem.
5. Click **Query Modem** to verify that the modem is communicating with Windows.

If all commands receive responses, the modem is operating properly.

---

## **Touch Pad or Mouse Problems**

Fill out the [Diagnostics Checklist](#) as you perform the various checks.

#### **Check the touch pad settings —**

##### *Windows XP*

1. Click the **Start** button, click **Control Panel**, and then click **Printers and Other Hardware**.

2. Click **Mouse**.
3. Try adjusting the settings.

#### *Windows 2000*

1. Click the **Start** button, point to **Settings**, and then click **Control Panel**.
2. Double-click the **Mouse** icon.
3. Try adjusting the settings.

**Check the mouse cable** — Shut down the computer. Disconnect the mouse cable, check it for damage, and firmly reconnect the cable.

If you are using a mouse extension cable, disconnect it and connect the mouse directly to the computer.

#### **To verify that the problem is with the mouse, check the touch pad —**

1. Shut down the computer.
2. Disconnect the mouse.
3. Turn on the computer.
4. At the Windows desktop, use the touch pad to move the cursor around, select an icon, and open it.

If the touch pad operates correctly, the mouse may be defective.

**Check the system setup program settings** — Verify that the system setup program lists the correct device for the pointing device option. (The computer automatically recognizes a USB mouse without making any setting adjustments.)

**Test the mouse controller** — To test the mouse controller (which affects pointer movement) and the operation of the touch pad or mouse buttons, run the Mouse test in the **Pointing Devices** test group in the [Dell Diagnostics](#).

**Reinstall the touch pad driver** — See "[Reinstalling Software](#)."

---

## External Keyboard Problems

Fill out the [Diagnostics Checklist](#) as you perform the various checks.

 **NOTE:** Use the integrated keyboard when working in MS-DOS® mode or when running the [Dell Diagnostics](#) or the system setup program. When you attach an external keyboard, the integrated keyboard remains fully functional.

**Check the keyboard cable** — Shut down the computer. Disconnect the keyboard cable and check it for damage, and firmly reconnect the cable.

If you are using a keyboard extension cable, disconnect it and connect the keyboard directly to the computer.

#### **Check the external keyboard —**

1. Shut down the computer, wait 1 minute, and turn it on again.
2. Verify that the numbers, capitals, and scroll lock lights on the keyboard blink during the boot routine.



3. From the Windows desktop, click the **Start** button, point to **Programs**, point to **Accessories**, and click **Notepad**.
4. Type some characters on the external keyboard and verify that they appear on the display.

If you cannot verify these steps, you may have a defective external keyboard.

**To verify that the problem is with the external keyboard, check the integrated keyboard —**

1. Shut down the computer.
2. Disconnect the external keyboard.
3. Turn on the computer.
4. From the Windows desktop, click the **Start** button, point to **Programs**, point to **Accessories**, and click **Notepad**.
5. Type some characters on the external keyboard and verify that they appear on the display.

If the characters appear now but did not with the external keyboard, you may have a defective external keyboard.

**Run the keyboard diagnostics tests —** Run the PC-AT Compatible Keyboards tests in the [Dell Diagnostics](#). If the tests indicate a defective external keyboard, [contact Dell](#).

---

## Unexpected Characters

**Disable the numeric keypad —** Press <Num Lk> to disable the numeric keypad if numbers are displayed instead of letters. Verify that the numbers lock light is not lit.

---

## Drive Problems

Fill out the [Diagnostics Checklist](#) as you complete these checks.

### If you cannot save a file to a floppy disk drive

**Ensure that Windows recognizes the drive —** *In Windows XP*, click the **Start** button and click **My Computer**. *In other operating systems*, double-click **My Computer**. If the drive is not listed, perform a full scan with your antivirus software to check for and remove viruses. Viruses can sometimes prevent Windows from recognizing the drive. Insert a bootable disk and restart the computer.

**Ensure that the disk is not write-protected —** You cannot save data to a write-protected disk.

**Try another floppy disk —** Insert another disk to eliminate the possibility that the original disk is defective.

**Reinstall the drive —**

1. Save and close any open files, exit any open programs, and shut down the computer.
2. Remove the drive from the module bay. See ["Using the Module Bay"](#) for instructions.
3. Reinstall the drive.

4. Turn on the computer.

**Clean the drive** — See "[Cleaning Your Computer](#)" for instructions.

**Check the drive for errors** —

- If a drive error message appears, see "[Error Messages](#)" for an explanation.
- Run the Diskette tests as described in "[Using the Dell Diagnostics](#)."

## If you cannot play a CD, CD-RW, DVD, or DVD+RW

 **NOTE:** Because of different worldwide file types, not all DVD titles work in all DVD drives.

High-speed CD drive vibration is normal and may cause noise. The noise does not indicate a defect with the drive or the CD.

**Ensure that Windows recognizes the drive** — *In Windows XP*, click the **Start** button and click **My Computer**. *In other operating systems*, double-click **My Computer**. If the drive is not listed, perform a full scan with your antivirus software to check for and remove viruses. Viruses can sometimes prevent Windows from recognizing the drive. Insert a bootable disk and restart the computer.

**Try another disc** — Insert another disc to eliminate the possibility that the original disc is defective.

**Adjust the Windows volume control** — Double-click the speaker icon in the lower-right corner of your screen. Ensure that the volume is turned up and that the sound is not muted.

**Reinstall the drive**

1. Save and close any open files, exit any open programs, and shut down the computer.
2. Remove the drive. See "[Using the Module Bay](#)" for instructions.
3. Reinstall the drive.
4. Turn on the computer.

**Clean the drive or disc** — See "[Cleaning Your Computer](#)" for instructions.

**Check the drive for errors**

If a drive error message appears, see "[Error Messages](#)" for an explanation.

Run the IDE Drives tests as described in the [Dell Diagnostics](#).

## If you cannot eject the CD, CD-RW, DVD, or DVD+RW drive tray

1. Ensure that the computer is turned off.
2. Straighten a paper clip and insert one end into the eject hole at the front of the drive; push firmly until the tray is partially ejected.
3. Gently pull out the tray until it stops.

## If you hear an unfamiliar scraping or grinding sound

- Ensure that the sound is not caused by the program that is running.
- Ensure that the disk or disc is inserted properly.

## If the CD-RW or DVD+RW drive stops writing

**Disable standby or hibernate mode in Windows before writing to a CD-RW** — Search for the keyword *standby* or *hibernate* in *Windows Help* or the Windows Help and Support Center.

**Change the write speed to a slower rate** — See the help files for your CD or DVD creation software.

**Exit all other open programs** — Exiting all other open programs before writing to the CD-RW or DVD+RW may alleviate the problem.

## If you have problems with a hard drive

**Allow the computer to cool before turning it on** — A hot hard drive may prevent the operating system from starting. Try allowing the computer to return to room temperature before turning it on.

### Check the drive for errors —

- Run the Windows error-checking tool:
  1. *In Windows XP*, click the **Start** button and click **My Computer**. *In Windows 2000*, double-click **My Computer**.
  2. Right-click the drive letter (local disk) that you want to scan for errors, and then click **Properties**.
  3. Click the **Tools** tab.
  4. Under **Error-checking**, click **Check Now**.
  5. Click **Start**.
- Run the IDE Drives tests as described in the [Dell Diagnostics](#).

---

## PC Card Problems

**Check the PC Card** — Ensure that the PC Card is properly inserted into the connector.

**Ensure that the card is recognized by Windows** — Double-click the **Safely Remove Hardware (Unplug or Eject Hardware** in Windows 2000) icon in the Windows taskbar. Ensure that the card is listed.

**Run the PC Card diagnostics test** — See the documentation that came with the PC Card for instructions if a diagnostics test was provided with the card.

**If you have problems with a Dell-provided PC Card** — [Contact Dell](#).

**If you have problems with a PC Card not provided by Dell** — Contact the PC Card manufacturer.

---

## Network Problems

Fill out the [Diagnostics Checklist](#) as you complete these checks.

**Check the network cable connector** — Ensure that the network cable connector is firmly connected to the connector on the computer and the network wall jack.

**Check the network lights on the network connector** — Green indicates that the network connection is active. If the status light is not green, try replacing the network cable. Amber indicates that the network adapter driver is loaded and the adapter is detecting activity.

**Restart the computer** — Try to log on to the network again.

**Contact your network administrator** — Verify that your network settings are correct and that the network is functioning.

---

## General Program Problems

Fill out the [Diagnostics Checklist](#) as you complete these checks.

### A program crashes

 **NOTE:** Software usually includes installation instructions in its documentation or on a floppy disk or CD.

**See the software documentation** — Many software manufacturers maintain websites with information that may help you solve the problem. Ensure that you properly installed and configured the program. Reinstall the program if necessary.

### A program stops responding

#### End the program

1. Simultaneously press <Ctrl><Shift><Esc>.
2. Click the **Applications** tab, and then select the program that is no longer responding.
3. Click **End Task**.

### A solid blue screen appears

**Turn the computer off** — If the computer does not respond to a keystroke or a proper shutdown, press the power button until the computer turns off. Press the power button again to restart the computer.

*Windows XP*

The computer restarts.

*Windows 2000*

The solid blue screen appears because you were not able to perform a proper Windows shutdown. ScanDisk automatically runs during the start-up process. Follow the instructions on

the screen.

## Error messages appear

**Review "Error Messages"** — Look up the message and take the appropriate action. See the software documentation.

**Confirm that the problem is software-related** — Run the System Board Devices tests in the [Dell Diagnostics](#). If all tests in the device group run successfully, the problem may be software-related. See the software documentation.

---

## If Your Dell™ Computer Gets Wet



**CAUTION:** Perform this procedure only after you are certain that it is safe to do so. If the computer is connected to an electrical outlet, it is recommended that you turn off AC power at the circuit breaker before attempting to remove the power cables from the electrical outlet. Use the utmost caution when removing wet cables from a live power source.

1. Shut down the computer, disconnect the AC adapter from the computer, and then disconnect the AC adapter from the electrical outlet.
2. Turn off any attached external devices, and disconnect them from their power sources and then from the computer.
3. Ground yourself by touching one of the metal connectors on the back of the computer.
4. Remove the module bay device and any installed PC Cards, and put them in a safe place to dry.
5. Remove the battery.
6. Wipe off the battery and put it in a safe place to dry.
7. [Remove the hard drive](#).
8. [Remove the memory module\(s\)](#).
9. Open the display and place the computer right-side up across two books or similar props to let air circulate all around it. Let the computer dry for at least 24 hours in a dry area at room temperature.



**NOTICE:** Do not use artificial means, such as a hair dryer or a fan, to speed the drying process.



**CAUTION:** To help prevent electrical shock, verify that the computer is thoroughly dry before continuing with the rest of this procedure.

10. Ground yourself by touching one of the metal connectors on the back of the computer.
11. Replace the memory module(s), the memory module cover, and the screw(s).
12. Replace the hard drive.
13. Replace the module bay device and any PC Cards you removed.

14. Replace the battery.
15. Turn on the computer and verify that it is working properly.

 **NOTE:** See your *System Information Guide* or separate paper warranty document that shipped with your computer for information on your warranty coverage.

If the computer does not start, or if you cannot identify the damaged components, [contact Dell](#).

---

## If You Drop or Damage Your Computer

1. Save and close any open files, exit any open programs, and shut down the computer.
2. Disconnect the AC adapter from the computer and from the electrical outlet.
3. Turn off any attached external devices, and disconnect them from their power sources and then from the computer.
4. Remove and reinstall the battery.
5. Turn on the computer.

 **NOTE:** See your *System Information Guide* for information on your warranty coverage.

If the computer does not start, or if you cannot identify the damaged components, [contact Dell](#).

---

## Resolving Other Technical Problems

**Go to the Dell Support website** — Go to **support.dell.com** for help with general usage, installation, and troubleshooting questions. See "[Getting Help](#)" for a description of the hardware and software support provided by Dell.

**E-mail Dell** — Go to **support.dell.com** and then click **E-Mail Dell** in the **Communicate** list. Send an e-mail message to Dell about your problem; you can expect to receive an e-mail message from Dell within hours. See "[Getting Help](#)" for a description of the hardware and software support provided by Dell.

**Contact Dell** — If you cannot solve your problem using the Dell Support website (**support.dell.com**) or e-mail service, call Dell for technical assistance. See "[Getting Help](#)" for a description of the hardware and software support provided by Dell.

# Solving Problems

- [Power Problems](#)
  - [Error Messages](#)
  - [Video and Display Problems](#)
  - [Sound and Speaker Problems](#)
  - [Printer Problems](#)
  - [Modem and Internet Connection Problems](#)
  - [Touch Pad or Mouse Problems](#)
  - [External Keyboard Problems](#)
  - [Unexpected Characters](#)
  - [Drive Problems](#)
  - [PC Card Problems](#)
  - [Network Problems](#)
  - [General Program Problems](#)
  - [If Your Dell™ Computer Gets Wet](#)
  - [If You Drop or Damage Your Computer](#)
  - [Resolving Other Technical Problems](#)
- 

## Power Problems

Fill out the [Diagnostics Checklist](#) as you complete these checks.

**Check the power light** — When the power light is lit or blinking, the computer has power. If the power light is blinking, the computer is in standby mode—press the power button to exit [standby mode](#). If the light is off, press the power button to turn on the computer.

**Charge the battery** — The battery charge may be depleted.

1. Reinstall the battery.
2. Use the AC adapter to connect the computer to an electrical outlet.
3. Turn on the computer.

**Check the battery status light** — If the battery status light flashes orange or is a steady

orange the battery charge is low or depleted. Connect the computer to an electrical outlet.

If the battery status light flashes green and orange, the battery is too hot to charge. Shut down the computer, disconnect the computer from the electrical outlet, and then let the battery and computer cool to room temperature.

If the battery status light rapidly flashes orange, the battery may be defective. [Contact Dell](#).

**Test the electrical outlet** — Ensure that the electrical outlet is working by testing it with another device, such as a lamp.

**Check the AC adapter** — Check the AC adapter cable connections. If the AC adapter has a light, ensure that the light is on.

**Connect the computer directly to an electrical outlet** — Bypass power protection devices, power strips, and the extension cable to verify that the computer turns on.

**Eliminate possible interference** — Turn off nearby fans, fluorescent lights, halogen lamps, or other appliances.

**Adjust the power properties** — See "[Power Management](#)."

**Reseat the memory modules** — If the computer power light turns on but the display remains blank, [reseat the memory modules](#).

## Error Messages

If the message is not listed, see the documentation for the operating system or the program that was running at the time the message appeared.

**Auxiliary device failure** — The touch pad or external mouse may be faulty. For an external mouse, check the cable connection. Enable the Pointing Device option in the system setup program. If the problem persists, [contact Dell](#).

**Bad command or file name** — Ensure that you have spelled the command correctly, put spaces in the proper place, and used the correct pathname.

**Cache disabled due to failure** — The primary cache internal to the microprocessor has failed. [Contact Dell](#).

**CD drive controller failure** — The CD drive does not respond to commands from the computer. See "[Drive Problems](#)."

**Data error** — The floppy or hard drive cannot read the data. See "[Drive Problems](#)."

**Decreasing available memory** — One or more memory modules may be faulty or improperly seated. Reseat the memory modules and, if necessary, replace them. See "[Memory](#)."

**Disk C: failed initialization** — The hard drive failed initialization. Run the Hard-Disk Drive tests as described in "[Using the Dell Diagnostics](#)."

**Floppy drive 0 seek failure** — The system configuration information may not match the hardware configuration. Run the Diskette tests as described in "[Using the Dell Diagnostics](#)."

**Diskette read failure** — The floppy disk may be defective. If the drive access light turns on, try a different disk. See "[Drive Problems](#)."

**Diskette subsystem reset failed** — The floppy drive controller may be faulty. Run the



<b>Diskette tests as described in "<a href="#">Using the Dell Diagnostics</a>."</b>
<b>Diskette write-protected</b> — Because the floppy disk is write-protected, the operation cannot be completed. Slide the write-protect notch.
<b>Drive not ready</b> — The operation requires a floppy disk in the drive or a hard drive in the bay before it can continue. Insert a floppy disk, or push the floppy disk all the way into the drive until the eject button pops out. Or, <a href="#">install a hard drive</a> in the hard drive bay.
<b>Error reading PCMCIA card</b> — The computer cannot identify the PC Card. Reinsert the card or try another PC Card.
<b>Extended memory size has changed</b> — The amount of memory recorded in NVRAM does not match the memory installed in the computer. Restart the computer. If the error appears again, <a href="#">contact Dell</a> .
<b>Gate A20 failure</b> — A memory module may be loose. <a href="#">Reinstall the memory modules</a> and, if necessary, replace them.
<b>General failure</b> — The operating system is unable to carry out the command. The message is usually followed by specific information—for example, <i>Printer out of paper</i> . Take the appropriate action.
<b>Hard-disk drive configuration error</b> — The computer cannot identify the drive type. Turn off the computer, <a href="#">remove the hard drive</a> , and boot the computer from a bootable floppy disk or CD. Then turn off the computer, reinstall the hard drive, and restart the computer. Run the Hard-Disk Drive tests as described in " <a href="#">Using the Dell Diagnostics</a> ."
<b>Hard-disk drive controller failure 0</b> — The hard drive does not respond to commands from the computer. Turn off the computer, <a href="#">remove the hard drive</a> , and boot the computer from a bootable floppy disk or CD. Then turn off the computer, reinstall the hard drive, and restart the computer. If the problem persists, try another drive. Run the Hard-Disk Drive tests as described in " <a href="#">Using the Dell Diagnostics</a> ."
<b>Hard-disk drive failure</b> — The hard drive does not respond to commands from the computer. Turn off the computer, <a href="#">remove the hard drive</a> , and boot the computer from a bootable floppy disk or CD. Then turn off the computer, reinstall the hard drive, and restart the computer. If the problem persists, try another drive. Run the Hard-Disk Drive tests as described in " <a href="#">Using the Dell Diagnostics</a> ."
<b>Hard-disk drive read failure</b> — The hard drive may be defective. Turn off the computer, <a href="#">remove the hard drive</a> , and boot the computer from a bootable floppy disk or CD. Then turn off the computer, reinstall the hard drive, and restart the computer. If the problem persists, try another drive. Run the Hard-Disk Drive tests as described in " <a href="#">Using the Dell Diagnostics</a> ."
<b>Insert bootable media</b> — The operating system is trying to boot to a nonbootable floppy disk or CD. Insert a bootable floppy disk or CD.
<b>Invalid configuration information-please run System Setup Program</b> — The system configuration information does not match the hardware configuration. The message is most likely to occur after a memory module is installed. Correct the appropriate options in the system setup program. See " <a href="#">Using the System Setup Program</a> ."
<b>Keyboard clock line failure</b> — For external keyboards, check the cable connection. Run the Keyboard Controller test as described in " <a href="#">Using the Dell Diagnostics</a> ."
<b>Keyboard controller failure</b> — For external keyboards, check the cable connection. Restart the computer, and avoid touching the keyboard or the mouse during the boot routine. Run the Keyboard Controller test as described in " <a href="#">Using the Dell Diagnostics</a> ."
<b>Keyboard data line failure</b> — For external keyboards, check the cable connection. Run the Keyboard Controller test as described in " <a href="#">Using the Dell Diagnostics</a> ."
<b>Keyboard stuck key failure</b> — For external keyboards or keypads, check the cable

connection. Restart the computer, and avoid touching the keyboard or keys during the boot routine. Run the Stuck Key test as described in "[Using the Dell Diagnostics.](#)"

**Memory address line failure at address, read value expecting value** — A memory module may be faulty or improperly seated. [Reinstall the memory modules](#) and, if necessary, replace them.

**Memory allocation error** — The software you are attempting to run is conflicting with the operating system, another program, or a utility. Turn off the computer, wait 30 seconds, and then restart it. Try to run the program again. If the error message still appears, see the software documentation.

**Memory data line failure at address, read value expecting value** — A memory module may be faulty or improperly seated. [Reinstall the memory modules](#) and, if necessary, replace them.

**Memory double word logic failure at address, read value expecting value** — A memory module may be faulty or improperly seated. [Reinstall the memory modules](#) and, if necessary, replace them.

**Memory odd/even logic failure at address, read value expecting value** — A memory module may be faulty or improperly seated. [Reinstall the memory modules](#) and, if necessary, replace them.

**Memory write/read failure at address, read value expecting value** — A memory module may be faulty or improperly seated. [Reinstall the memory modules](#) and, if necessary, replace them.

**No boot device available** — The computer cannot find the floppy disk or hard drive. If the floppy drive is your boot device, ensure that a bootable floppy disk is in the drive. If the hard drive is your boot device, ensure that the drive is installed, properly seated, and partitioned as a boot device.

**No boot sector on hard drive** — The operating system may be corrupted. [Contact Dell.](#)

**No timer tick interrupt** — A chip on the system board may be malfunctioning. Run the System Set tests as described in "[Using the Dell Diagnostics.](#)"

**Non-system disk or disk error** — A floppy disk is in the floppy drive. Remove the floppy disk and restart the computer.

**Not a boot diskette** — The operating system is trying to boot to a nonbootable floppy disk. Insert a bootable floppy disk.

**Operating system not found** — [Contact Dell.](#)

**Optional ROM bad checksum** — The optional ROM apparently failed. [Contact Dell.](#)

**A required .DLL file was not found** — The program that you are trying to open is missing an essential file. Remove and then reinstall the program.

#### **Microsoft® Windows® XP**

1. Click the Start button and click Control Panel.
2. Click Add or Remove Programs.
3. Select the program you want to remove.
4. Click Remove or Change/Remove and follow the prompts on the screen.
5. See the program documentation for installation instructions.

#### **Windows 2000**

1. Click the Start button, point to Settings, and then click Control Panel.
2. Double-click the Add/Remove Programs icon.
3. Select the program that you want to remove.

4. Click Change or Remove Programs.
5. See the program documentation for installation instructions.

**Sector not found** — The operating system cannot locate a sector on the floppy or hard drive. You may have a defective sector or corrupted FAT on the floppy disk or hard drive. Run the Windows error-checking utility to check the file structure on the floppy disk or hard drive. See *Windows Help* for instructions. If a large number of sectors are defective, back up the data (if possible), and then reformat the floppy disk or hard drive.

**Seek error** — The operating system cannot find a specific track on the floppy disk or hard drive. If the error is on the floppy disk, try another floppy disk.

**Shutdown failure** — A chip on the system board may be malfunctioning. Run the System Set tests as described in "[Using the Dell Diagnostics](#)."

**Time-of-day clock lost power** — System configuration settings are corrupted. Connect your computer to an electrical outlet to charge the battery. If the problem persists, try to restore the data by entering the system setup program. Then immediately exit the program. See "[Using the System Setup Program](#)." If the message reappears, [contact Dell](#).

**Time-of-day clock stopped** — The reserve battery that supports the system configuration settings may require recharging. Connect your computer to an electrical outlet to charge the battery. If the problem persists, [contact Dell](#).

**Time-of-day not set-please run the System Setup program** — The time or date stored in the system setup program does not match the system clock. Correct the settings for the Date and Time options. See "[Using the System Setup Program](#)."

**Timer chip counter 2 failed** — A chip on the system board may be malfunctioning. Run the System Set tests as described in "[Using the Dell Diagnostics](#)."

**Unexpected interrupt in protected mode** — The keyboard controller may be malfunctioning, or a memory module may be loose. Run the System Memory tests and the Keyboard Controller test as described in "[Using the Dell Diagnostics](#)."

**x:\ is not accessible. The device is not ready** — Insert a disk into the drive and try again.

**Warning: Battery is critically low** — The [battery is running out of charge](#). Replace the battery, or connect the computer to an electrical outlet. Otherwise, activate [hibernate mode](#) or turn off the computer.

## Video and Display Problems

Fill out the [Diagnostics Checklist](#) as you complete these checks.

### If the display is blank

 **NOTE:** If you are using a program that requires a higher resolution than your computer supports, it is recommended that you attach an external monitor to your computer.

**Check the battery** — If you are using a battery to power your computer, the battery charge may be depleted. Connect the computer to an electrical outlet using the AC adapter, and turn on the computer.

**Test the electrical outlet** — Ensure that the electrical outlet is working by testing it with another device, such as a lamp.

**Check the AC adapter** — Check the AC adapter cable connections. If the AC adapter has a light, ensure that the light is on.

**Connect the computer directly to an electrical outlet** — Bypass power protection devices, power strips, and the extension cable to verify that the computer turns on.

**Adjust the power properties** — Search for the keyword *standby* in *Windows Help* or the *Windows Help and Support Center*.

**Switch the video image** — If your computer is attached to an external monitor, press <Fn><F8> to switch the video image to the display.

## If the display is difficult to read

**Adjust the brightness** — See "[Adjusting Brightness](#)" for instructions on adjusting the brightness.

**Move the subwoofer away from the computer or monitor** — If your external speaker system includes a subwoofer, ensure that the subwoofer is at least 60 cm (2 ft) away from the computer or external monitor.

**Eliminate possible interference** — Turn off nearby fans, fluorescent lights, halogen lamps, or other appliances.

**Rotate the computer to face a different direction** — Eliminate sunlight glare, which can cause poor picture quality.

### Adjust the Windows display settings —

#### *Windows XP*

1. Click the **Start** button and then click **Control Panel**.
2. Click **Appearance and Themes**.
3. Click the area you want to change or click the **Display** icon.
4. Try different settings for **Color quality** and **Screen resolution**.

#### *Windows 2000*

1. Click the **Start** button, point to **Settings**, and then click **Control Panel**.
2. Double-click the **Display** icon and click the **Settings** tab.
3. Try different settings for **Colors**, **Screen area**, and **Advanced Settings**.

**Run the Video diagnostics tests** — If no error message appears and you still have a display problem, but the display is not completely blank, run the **Video** device group in the [Dell Diagnostics](#). Then [contact Dell](#).

**See "Error Messages"** — If an error message appears, see "[Error Messages](#)."

## If only part of the display is readable

### Connect an external monitor —

1. Shut down your computer and connect an external monitor to the computer.
2. Turn on the computer and the monitor and adjust the monitor brightness and contrast controls.

If the external monitor works, the computer display or video controller may be defective. [Contact Dell.](#)

---

## Sound and Speaker Problems

Fill out the [Diagnostics Checklist](#) as you complete these checks.

### If you have a problem with integrated speakers

**Adjust the Windows volume control** — Double-click the speaker icon in the lower-right corner of your screen. Ensure that the volume is turned up and that the sound is not muted. Adjust the volume, bass, or treble controls to eliminate distortion.

**Adjust the volume using keyboard shortcuts** — See "[Using the Keyboard and Touch Pad.](#)" Press <Fn><End> to disable (mute) or reenable the integrated speakers.

**Reinstall the sound (audio) driver** — See "[Reinstalling Software.](#)"

**For Windows 2000 only, ensure that digital audio for the CD drive is enabled** —

1. Click the **Start** button, point to **Settings**, and then click **Control Panel**.
2. Double-click the **System** icon.
3. Click the **Hardware** tab.
4. Click **Device Manager**.
5. Double-click **DVD/CD-ROM drives**.
6. Double-click the name of the drive.
7. On the drive **Properties** screen, click the **Properties** tab.
8. Click the box near the bottom of the screen to enable digital audio for your CD or DVD drive.

### If you have a problem with external speakers

 **NOTE:** The volume control in some MP3 players overrides the Windows volume setting. If you have been listening to MP3 songs, make sure that you did not turn the player volume down or off.

**Check the speaker cable connections** — See the setup diagram supplied with the speakers.

**Test the electrical outlet** — Ensure that the electrical outlet is working by testing it with another device, such as a lamp.

**Ensure that the speakers are turned on** — See the setup diagram supplied with the speakers.

**Adjust the Windows volume control** — Double-click the speaker icon in the lower-right corner of your screen. Ensure that the volume is turned up and that the sound is not muted. Adjust the volume, bass, or treble controls to eliminate distortion.

**Test the speakers** — Plug the speaker audio cable in to the  connector on the computer. Ensure that the headphone volume control is turned up. Play a music CD.

**Run the speaker self-test** — Some speaker systems have a self-test button on the subwoofer. See the speaker documentation for self-test instructions.

**Eliminate possible interference** — Turn off nearby fans, fluorescent lights, or halogen lamps to check for interference.

**Reinstall the sound (audio) driver** — See "[Reinstalling Software](#)."

**Run the Misc. PCI Devices diagnostic test** — See "[Using the Dell Diagnostics](#)." If the tests complete successfully, the controller is functioning properly.

If the problem persists, or if the tests do not complete successfully, [contact Dell](#).

**For Windows 2000 only, ensure that digital audio for the CD drive is enabled** —

1. Click the **Start** button, point to **Settings**, and then click **Control Panel**.
2. Double-click the **System** icon.
3. Click the **Hardware** tab.
4. Click **Device Manager**.
5. Double-click **DVD/CD-ROM drives**.
6. Double-click the name of the drive.
7. On the drive **Properties** screen, click the **Properties** tab.
8. Click the box near the bottom of the screen to enable digital audio for your CD or DVD drive.

---

## Printer Problems

Fill out the [Diagnostics Checklist](#) as you perform the various checks.

**Check the printer cable connections** — Ensure that the printer cable is properly connected to the computer.

**Check the printer cable** —

1. Shut down the computer and turn off the printer.
2. Swap the printer cable with a cable that you know is working.
3. Turn on the printer and computer, and try again to print.
4. If you print successfully, [contact Dell](#) for assistance in obtaining a new printer cable.

**Test the electrical outlet** — Ensure that the electrical outlet is working by testing it with another device, such as a lamp.

**Ensure that the printer is turned on** — See the documentation supplied with the printer.

**Verify that Windows recognizes the printer** —

*Windows XP*

1. Click the **Start** button and click **Control Panel**.
2. Click **Printers and Other Hardware**.
3. Click **View installed printers or fax printers**. If the printer model is listed, right-click the printer icon.
4. Click **Properties** and click the **Ports** tab. Ensure that the **Print to the following port (s)**: setting is **LPT1 (Printer Port)**.

*Windows 2000*

1. Click the **Start** button, point to **Settings**, and then click **Printers**.



If the printer model is listed, right-click the printer icon.

2. Click **Properties** and click the **Ports** tab.
3. Ensure that the **Print to the following port:** option is set for your printer type:
  - For a parallel printer: **LPT1 (Printer Port)**
  - For a USB printer: **USB**

**Reinstall the printer driver** — See "[Reinstalling Software](#)."

**Check the printer** — Run the printer self-test. If the test does not complete successfully, the printer is probably defective. Contact the printer manufacturer.

## Modem and Internet Connection Problems

-  **NOTICE:** Connect the modem to an analog telephone wall jack only. Connecting the modem to a digital telephone network may damage the modem.
-  **NOTICE:** Modem and network connectors look similar. Do not plug a telephone line in to the network connector.

Fill out the [Diagnostics Checklist](#) as you complete these checks.

-  **NOTE:** If you can connect to your Internet service provider (ISP), your modem is functioning properly. If you are sure that your modem is working properly and you still experience problems, contact your ISP.

**Check the telephone wall jack** — Disconnect the telephone line from the modem and connect it to a telephone. Listen for a dial tone. Ensure that you have touchtone telephone service. Try connecting the modem to a different telephone wall jack.

Slow connection speeds can be caused by telephone noise as well as by telephone line or network conditions. Contact your telephone company or network administrator for more information.

**Connect the modem directly to the telephone wall jack** — If you have other telephone devices sharing the line, such as an answering machine, fax machine, surge protector, or line splitter, then bypass them and use the telephone line to connect the modem directly to the telephone wall jack.

**Check the connection** — Verify that the telephone line is connected to the modem.

**Check the telephone line** — Try using a different telephone line. If you are using a line that is 3 m (10 ft) or more in length, try a shorter one.

**Irregular dial tone** — If you have voice mail service, you might hear an irregular dial tone when you have messages. Contact your telephone company for instructions on restoring a dial tone.

**Turn off call waiting (catch-phone)** — See your telephone directory for instructions on deactivating this feature. Then adjust the dial-up networking connection properties.

*Windows XP*

1. Click the **Start** button and click **Control Panel**.
2. Click **Printers and Other Hardware**, click **Phone and Modem Options**, click the **Dialing Rules** tab, and then click **Edit...**
3. In the **Edit Location** window, ensure that **To disable call waiting, dial:** is checked, and

then select the proper code as listed in your telephone directory.

4. Click **Apply** and click **OK**.
5. Close the **Phone and Modems Options** window.
6. Close the **Control Panel** window.

#### *Windows 2000*

1. Click the **Start** button, point to **Settings**, and then click **Control Panel**.
2. Click **Phone and Modem Options**.
3. Click the **Dialing Rules** tab and click **Edit**.
4. Ensure that **To disable call waiting, dial:** is checked, and then select the proper code as listed in your telephone directory.
5. Click **Apply** and click **OK**.
6. Close the **Phone and Modem Options** window.

#### **Verify that the modem is communicating with Windows —**

##### *Windows XP*

1. Click the **Start** button and click **Control Panel**.
2. Click **Printers and Other Hardware** and click **Phone and Modem Options**.
3. Click the **Modems** tab.
4. Click the COM port for your modem.
5. Click **Properties**, click the **Diagnostics** tab, and then click **Query Modem** to verify that the modem is communicating with Windows.

If all commands receive responses, the modem is operating properly.

##### *Windows 2000*

1. Click the **Start** button, point to **Settings**, and then click **Control Panel**.
2. Double-click **Phone and Modem Options**.

If multiple entries for the same modem or modems are listed but not installed, delete the entries, restart the computer, and repeat steps 1 and 2.

3. Click the **Diagnostics** tab.
4. Click the COM port for your modem.
5. Click **Query Modem** to verify that the modem is communicating with Windows.

If all commands receive responses, the modem is operating properly.

---

## **Touch Pad or Mouse Problems**

Fill out the [Diagnostics Checklist](#) as you perform the various checks.

#### **Check the touch pad settings —**

##### *Windows XP*

1. Click the **Start** button, click **Control Panel**, and then click **Printers and Other Hardware**.



2. Click **Mouse**.
3. Try adjusting the settings.

#### *Windows 2000*

1. Click the **Start** button, point to **Settings**, and then click **Control Panel**.
2. Double-click the **Mouse** icon.
3. Try adjusting the settings.

**Check the mouse cable** — Shut down the computer. Disconnect the mouse cable, check it for damage, and firmly reconnect the cable.

If you are using a mouse extension cable, disconnect it and connect the mouse directly to the computer.

#### **To verify that the problem is with the mouse, check the touch pad —**

1. Shut down the computer.
2. Disconnect the mouse.
3. Turn on the computer.
4. At the Windows desktop, use the touch pad to move the cursor around, select an icon, and open it.

If the touch pad operates correctly, the mouse may be defective.

**Check the system setup program settings** — Verify that the system setup program lists the correct device for the pointing device option. (The computer automatically recognizes a USB mouse without making any setting adjustments.)

**Test the mouse controller** — To test the mouse controller (which affects pointer movement) and the operation of the touch pad or mouse buttons, run the Mouse test in the **Pointing Devices** test group in the [Dell Diagnostics](#).

**Reinstall the touch pad driver** — See "[Reinstalling Software](#)."

---

## External Keyboard Problems

Fill out the [Diagnostics Checklist](#) as you perform the various checks.

 **NOTE:** Use the integrated keyboard when working in MS-DOS® mode or when running the [Dell Diagnostics](#) or the system setup program. When you attach an external keyboard, the integrated keyboard remains fully functional.

**Check the keyboard cable** — Shut down the computer. Disconnect the keyboard cable and check it for damage, and firmly reconnect the cable.

If you are using a keyboard extension cable, disconnect it and connect the keyboard directly to the computer.

#### **Check the external keyboard —**

1. Shut down the computer, wait 1 minute, and turn it on again.
2. Verify that the numbers, capitals, and scroll lock lights on the keyboard blink during the boot routine.

3. From the Windows desktop, click the **Start** button, point to **Programs**, point to **Accessories**, and click **Notepad**.
4. Type some characters on the external keyboard and verify that they appear on the display.

If you cannot verify these steps, you may have a defective external keyboard.

**To verify that the problem is with the external keyboard, check the integrated keyboard —**

1. Shut down the computer.
2. Disconnect the external keyboard.
3. Turn on the computer.
4. From the Windows desktop, click the **Start** button, point to **Programs**, point to **Accessories**, and click **Notepad**.
5. Type some characters on the external keyboard and verify that they appear on the display.

If the characters appear now but did not with the external keyboard, you may have a defective external keyboard.

**Run the keyboard diagnostics tests —** Run the PC-AT Compatible Keyboards tests in the [Dell Diagnostics](#). If the tests indicate a defective external keyboard, [contact Dell](#).

---

## Unexpected Characters

**Disable the numeric keypad —** Press <Num Lk> to disable the numeric keypad if numbers are displayed instead of letters. Verify that the numbers lock light is not lit.

---

## Drive Problems

Fill out the [Diagnostics Checklist](#) as you complete these checks.

### If you cannot save a file to a floppy disk drive

**Ensure that Windows recognizes the drive —** *In Windows XP*, click the **Start** button and click **My Computer**. *In other operating systems*, double-click **My Computer**. If the drive is not listed, perform a full scan with your antivirus software to check for and remove viruses. Viruses can sometimes prevent Windows from recognizing the drive. Insert a bootable disk and restart the computer.

**Ensure that the disk is not write-protected —** You cannot save data to a write-protected disk.

**Try another floppy disk —** Insert another disk to eliminate the possibility that the original disk is defective.

**Reinstall the drive —**

1. Save and close any open files, exit any open programs, and shut down the computer.
2. Remove the drive from the module bay. See ["Using the Module Bay"](#) for instructions.
3. Reinstall the drive.

4. Turn on the computer.

**Clean the drive** — See "[Cleaning Your Computer](#)" for instructions.

**Check the drive for errors** —

- If a drive error message appears, see "[Error Messages](#)" for an explanation.
- Run the Diskette tests as described in "[Using the Dell Diagnostics](#)."

## If you cannot play a CD, CD-RW, DVD, or DVD+RW

 **NOTE:** Because of different worldwide file types, not all DVD titles work in all DVD drives.

High-speed CD drive vibration is normal and may cause noise. The noise does not indicate a defect with the drive or the CD.

**Ensure that Windows recognizes the drive** — *In Windows XP*, click the **Start** button and click **My Computer**. *In other operating systems*, double-click **My Computer**. If the drive is not listed, perform a full scan with your antivirus software to check for and remove viruses. Viruses can sometimes prevent Windows from recognizing the drive. Insert a bootable disk and restart the computer.

**Try another disc** — Insert another disc to eliminate the possibility that the original disc is defective.

**Adjust the Windows volume control** — Double-click the speaker icon in the lower-right corner of your screen. Ensure that the volume is turned up and that the sound is not muted.

**Reinstall the drive**

1. Save and close any open files, exit any open programs, and shut down the computer.
2. Remove the drive. See "[Using the Module Bay](#)" for instructions.
3. Reinstall the drive.
4. Turn on the computer.

**Clean the drive or disc** — See "[Cleaning Your Computer](#)" for instructions.

**Check the drive for errors**

If a drive error message appears, see "[Error Messages](#)" for an explanation.

Run the IDE Drives tests as described in the [Dell Diagnostics](#).

## If you cannot eject the CD, CD-RW, DVD, or DVD+RW drive tray

1. Ensure that the computer is turned off.
2. Straighten a paper clip and insert one end into the eject hole at the front of the drive; push firmly until the tray is partially ejected.
3. Gently pull out the tray until it stops.

## If you hear an unfamiliar scraping or grinding sound

- Ensure that the sound is not caused by the program that is running.
- Ensure that the disk or disc is inserted properly.

## If the CD-RW or DVD+RW drive stops writing

**Disable standby or hibernate mode in Windows before writing to a CD-RW** — Search for the keyword *standby* or *hibernate* in *Windows Help* or the Windows Help and Support Center.

**Change the write speed to a slower rate** — See the help files for your CD or DVD creation software.

**Exit all other open programs** — Exiting all other open programs before writing to the CD-RW or DVD+RW may alleviate the problem.

## If you have problems with a hard drive

**Allow the computer to cool before turning it on** — A hot hard drive may prevent the operating system from starting. Try allowing the computer to return to room temperature before turning it on.

### Check the drive for errors —

- Run the Windows error-checking tool:
  1. *In Windows XP*, click the **Start** button and click **My Computer**. *In Windows 2000*, double-click **My Computer**.
  2. Right-click the drive letter (local disk) that you want to scan for errors, and then click **Properties**.
  3. Click the **Tools** tab.
  4. Under **Error-checking**, click **Check Now**.
  5. Click **Start**.
- Run the IDE Drives tests as described in the [Dell Diagnostics](#).

---

## PC Card Problems

**Check the PC Card** — Ensure that the PC Card is properly inserted into the connector.

**Ensure that the card is recognized by Windows** — Double-click the **Safely Remove Hardware (Unplug or Eject Hardware** in Windows 2000) icon in the Windows taskbar. Ensure that the card is listed.

**Run the PC Card diagnostics test** — See the documentation that came with the PC Card for instructions if a diagnostics test was provided with the card.

**If you have problems with a Dell-provided PC Card** — [Contact Dell](#).

**If you have problems with a PC Card not provided by Dell** — Contact the PC Card manufacturer.

---

## Network Problems

Fill out the [Diagnostics Checklist](#) as you complete these checks.

**Check the network cable connector** — Ensure that the network cable connector is firmly connected to the connector on the computer and the network wall jack.

**Check the network lights on the network connector** — Green indicates that the network connection is active. If the status light is not green, try replacing the network cable. Amber indicates that the network adapter driver is loaded and the adapter is detecting activity.

**Restart the computer** — Try to log on to the network again.

**Contact your network administrator** — Verify that your network settings are correct and that the network is functioning.

---

## General Program Problems

Fill out the [Diagnostics Checklist](#) as you complete these checks.

### A program crashes

 **NOTE:** Software usually includes installation instructions in its documentation or on a floppy disk or CD.

**See the software documentation** — Many software manufacturers maintain websites with information that may help you solve the problem. Ensure that you properly installed and configured the program. Reinstall the program if necessary.

### A program stops responding

#### End the program

1. Simultaneously press <Ctrl><Shift><Esc>.
2. Click the **Applications** tab, and then select the program that is no longer responding.
3. Click **End Task**.

### A solid blue screen appears

**Turn the computer off** — If the computer does not respond to a keystroke or a proper shutdown, press the power button until the computer turns off. Press the power button again to restart the computer.

*Windows XP*

The computer restarts.

*Windows 2000*

The solid blue screen appears because you were not able to perform a proper Windows shutdown. ScanDisk automatically runs during the start-up process. Follow the instructions on

the screen.

## Error messages appear

**Review "Error Messages"** — Look up the message and take the appropriate action. See the software documentation.

**Confirm that the problem is software-related** — Run the System Board Devices tests in the [Dell Diagnostics](#). If all tests in the device group run successfully, the problem may be software-related. See the software documentation.

---

## If Your Dell™ Computer Gets Wet



**CAUTION:** Perform this procedure only after you are certain that it is safe to do so. If the computer is connected to an electrical outlet, it is recommended that you turn off AC power at the circuit breaker before attempting to remove the power cables from the electrical outlet. Use the utmost caution when removing wet cables from a live power source.

1. Shut down the computer, disconnect the AC adapter from the computer, and then disconnect the AC adapter from the electrical outlet.
2. Turn off any attached external devices, and disconnect them from their power sources and then from the computer.
3. Ground yourself by touching one of the metal connectors on the back of the computer.
4. Remove the module bay device and any installed PC Cards, and put them in a safe place to dry.
5. Remove the battery.
6. Wipe off the battery and put it in a safe place to dry.
7. [Remove the hard drive](#).
8. [Remove the memory module\(s\)](#).
9. Open the display and place the computer right-side up across two books or similar props to let air circulate all around it. Let the computer dry for at least 24 hours in a dry area at room temperature.



**NOTICE:** Do not use artificial means, such as a hair dryer or a fan, to speed the drying process.



**CAUTION:** To help prevent electrical shock, verify that the computer is thoroughly dry before continuing with the rest of this procedure.

10. Ground yourself by touching one of the metal connectors on the back of the computer.
11. Replace the memory module(s), the memory module cover, and the screw(s).
12. Replace the hard drive.
13. Replace the module bay device and any PC Cards you removed.

14. Replace the battery.
15. Turn on the computer and verify that it is working properly.

 **NOTE:** See your *System Information Guide* or separate paper warranty document that shipped with your computer for information on your warranty coverage.

If the computer does not start, or if you cannot identify the damaged components, [contact Dell](#).

---

## If You Drop or Damage Your Computer

1. Save and close any open files, exit any open programs, and shut down the computer.
2. Disconnect the AC adapter from the computer and from the electrical outlet.
3. Turn off any attached external devices, and disconnect them from their power sources and then from the computer.
4. Remove and reinstall the battery.
5. Turn on the computer.

 **NOTE:** See your *System Information Guide* for information on your warranty coverage.

If the computer does not start, or if you cannot identify the damaged components, [contact Dell](#).

---

## Resolving Other Technical Problems

**Go to the Dell Support website** — Go to **support.dell.com** for help with general usage, installation, and troubleshooting questions. See "[Getting Help](#)" for a description of the hardware and software support provided by Dell.

**E-mail Dell** — Go to **support.dell.com** and then click **E-Mail Dell** in the **Communicate** list. Send an e-mail message to Dell about your problem; you can expect to receive an e-mail message from Dell within hours. See "[Getting Help](#)" for a description of the hardware and software support provided by Dell.

**Contact Dell** — If you cannot solve your problem using the Dell Support website (**support.dell.com**) or e-mail service, call Dell for technical assistance. See "[Getting Help](#)" for a description of the hardware and software support provided by Dell.

# Using PC Cards

- [PC Card Types](#)
- [Extended PC Cards](#)
- [Installing a PC Card](#)
- [Removing a PC Card](#)



**CAUTION:** Before performing any of the procedures listed below, read and follow the safety instructions in the *System Information Guide*.

---

## PC Card Types

See "[Specifications](#)" for information on supported PC Cards.



**NOTE:** A PC Card is not a bootable device.

The PC Card slot has one connector that supports a single Type I or Type II card. The PC Card slot supports CardBus technology and extended PC Cards. "Type" of card refers to its thickness, not its functionality.

---

## Extended PC Cards

An extended PC Card (for example, a wireless network adapter) is longer than a standard PC Card and extends outside the computer. Follow these precautions when using extended PC Cards:

- Protect the exposed end of an installed card. Striking the end of the card can damage the system board.
  - Always remove an extended PC Card before you pack the computer in its carrying case.
  - Install an extended card in the upper PC Card connector to allow room for a second PC Card.
- 

## Installing a PC Card

You can install a PC Card in the computer while the computer is running. The computer automatically detects the card.

PC Cards are generally marked with a symbol (such as a triangle or an arrow) to indicate which end to insert into the slot. The cards are keyed to prevent incorrect insertion. If card orientation is not clear, see the documentation that came with the card.



To install a PC Card:

1. Hold the card with its orientation symbol pointing into the slot and the top side of the card facing up. The latch needs to be in the "in" position before you insert the card.
2. Slide the card into the slot until the card is completely seated in its connector.



If you encounter too much resistance, do not force the card. Check the card orientation and try again.



The computer recognizes most PC Cards and automatically loads the appropriate device driver. If the configuration program tells you to load the manufacturer's drivers, use the floppy disk or CD that came with the PC Card.

---

## Removing a PC Card

 **NOTICE:** Before you remove a PC Card from the computer, click the  icon on the taskbar to select a card and stop it from functioning. If you do not stop the card in the configuration utility, you could lose data. Do not attempt to eject a card by pulling its cable, if one is attached.

1. Press the eject button.



1	eject button
---	--------------

2. Push the eject button a second time.
3. Gently remove the card.



1	eject button
2	PC Card

# Connecting to a Wireless Local Area Network

- [Determining Your Network Type](#)
- [Connecting to a Network in Microsoft® Windows® XP](#)
- [Finalizing Your Network Connection \(Security Settings\)](#)

 **NOTE:** These networking instructions do not apply to Bluetooth™ or cellular products.

Before you can connect to a wireless Local Area Network (LAN), you must have specific information about your network. Be sure to get the name of your wireless network along with any special security settings from your network administrator. The settings are unique to your network and cannot be provided by Dell.

---

## Determining Your Network Type

 **NOTE:** Most wireless networks are of the infrastructure type. Consult your network administrator if you are unsure of the type of network you are connecting to.

Wireless networks fall into two categories—infrastructure networks and ad-hoc networks. An infrastructure network uses routers or access points to connect several computers. An ad-hoc network does not use routers or access points and consists of computers that broadcast to one another.

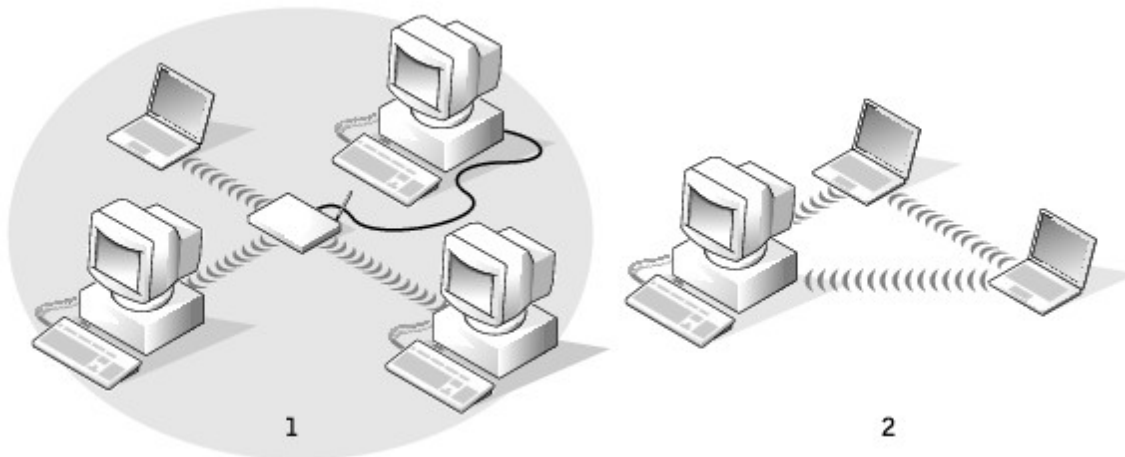

1	infrastructure network
2	Ad-Hoc network

---

## Connecting to a Network in Microsoft® Windows® XP

Your wireless network card requires proper software and drivers in order to connect to a network. The software is pre-installed in the factory. If the software is removed or corrupted, follow the instructions listed in the *User's Guide* for your wireless card. The *User's Guide* is located on your *Drivers and Utilities* CD (that came with your computer) in the "User's Guides-Network User's Guides" category. The *User's Guide* is also available on the Dell Support website at [support.dell.com](http://support.dell.com).

1. Click the **Start** button, click **Control Panel**, and then click **Switch to Classic View**.
2. Double-click **Network Connections**.
3. Click **Wireless Network Connection**.

The **Wireless Network Connection** icon is highlighted.

4. Under **Network Tasks** in the left-hand pane, click **Change settings of this connection**.

The **Wireless Network Connection Properties** window appears.

5. Select the **Wireless Networks** tab.



**NOTE:** The names of wireless networks that your computer can detect are listed under **Available Networks**.

6. Click **Add**.

The **Wireless network properties** window appears.

7. Enter the name of your network in the **Network name (SSID)** field.
8. If you are connecting to an ad-hoc network, which does not use any routers or access points, click the check box labeled **This is a computer-to-computer (ad hoc) network; wireless access points are not used**.
9. Click **OK**.

Your new network name appears in the **Preferred networks** area.

---

## Finalizing Your Network Connection (Security Settings)

To finalize your connection, you must change your wireless security settings to match the wireless network you are trying to connect to. Choose one of the following connection options based on the security settings for your network:

- Connecting to a Network without Security-Related Requirements (common for home and small office networks)
- Connecting to a Network with Wi-Fi Protected Access (WPA) Security Requirements
- Connecting to a Network with Wired Equivalent Protocol (WEP) Security Requirements



**NOTE:** Network security settings are only provided by your network administrator and are unique to

your network. Dell cannot provide this information.

## Connecting to a Network Without Security-Related Requirements

1. In the **Preferred networks** area, click the name of your wireless network.
2. Click **Properties**.
3. From the **Network Authentication** drop-down menu, select **Open**.

Earlier versions of the Dell™ wireless software may not contain the drop-down menu. If you are using an earlier version, click to uncheck the **Data encryption (WEP enabled)** check box and go to [step 5](#).

4. From the **Data encryption** drop-down menu, select **Disabled**.



**NOTE:** Your computer can take up to 1 minute to connect to the network.

5. Click **OK**.

Your network setup is complete.

## Connecting to a Network With Wi-Fi Protected Access (WPA) Security Requirements

The following instructions are basic steps for connecting to a WPA network. If your network requires a user name, password, or domain settings, consult the setup instructions in the *User's Guide* for your wireless network card.



**NOTE:** WPA protocols require that you know the Network Authentication and Data Encryption settings for your wireless network. In addition, your WPA-protected network may require special settings such as a network key, user name, password, and domain name. Be sure to get all necessary WPA settings from your network administrator before continuing.

1. In the **Preferred networks** section, click the name of your wireless network.
2. Click **Properties**.
3. From the **Network Authentication** drop-down menu, select your network authentication type (as provided by the network administrator).

If you do not see the drop-down menu, you must update your wireless software before continuing. Download and install the latest version of your wireless driver software from the Dell Support website at [support.dell.com](http://support.dell.com).

4. From the **Data encryption** drop-down menu, select your data encryption type (as provided by the network administrator).
5. If your wireless network requires a key, enter it in the **Network key** field.

 **NOTE:** Your computer can take up to 1 minute to connect to the network.

6. Click **OK**.

Your network setup is complete.

## Connecting to a Network With Wired Equivalent Protocol (WEP) Security Requirements

1. In the **Preferred networks** section, click the name of your wireless network.
2. Click **Properties**.
3. From the **Network Authentication** drop-down menu, select **Open**.

Earlier versions of Dell wireless software may not contain the drop-down menus. If you are using an earlier version, click to check the check box labeled **Data encryption (WEP enabled)** and go to [step 5](#).

4. From the **Data encryption** drop-down menu, select **WEP**.
5. If the wireless network does not require a network key (for example, a password), go to [step 8](#).
6. Click to uncheck the check box labeled **The key is provided for me automatically**.
7. Enter the WEP network key, provided by your network administrator, in the **Network key** field.
8. Enter the WEP network key again in the **Confirm network key** field.

 **NOTE:** Your computer can take up to 1 minute to connect to the network.

9. Click **OK**.

Your network setup is complete.

# Power Management

- [Power Management Tips](#)
  - [Power Management Wizard](#)
  - [Power Management Modes](#)
  - [Power Options Properties](#)
- 

## Power Management Tips

 **NOTE:** See "[Using a Battery](#)" for more information on conserving battery power.

- Connect the computer to an electrical outlet when possible because battery life is largely determined by the number of times the battery is charged.
  - Place the computer in [standby mode](#) or [hibernate mode](#) when you leave the computer unattended for long periods of time.
  - To enter a power management mode, close the display or press <Fn><Esc>.
  - To exit a power management mode, press the power button.
- 

## Power Management Wizard

 **NOTE:** The **Power Management Wizard** is not available if you have restricted access rights.

Click or double-click the  icon to open the **Power Management Wizard**.

The first two screens of the wizard—**Welcome** and **What is Power Management?**—describe and define various power management options.

 **NOTE:** On the **What is Power Management?** screen, you can select **Do not show this page again**. When you select this option, the **Welcome** screen also does not appear again.

Use the following screens of the **Power Management Wizard** to set various power management options, including sleep modes, power schemes, and low battery-charge alarms.

## Setting Sleep Modes

The screen defines standby and hibernate modes. From the screen you can:

- Set standby-mode password options.
- Enable or disable hibernate mode.
- Select how the computer will respond when you close the display:
  - Choose no action.
  - Enter standby mode.
  - Enter hibernate mode.
- Select how the computer will respond when you press the power button:
  - Choose no action.
  - Enter standby mode.
  - Enter hibernate mode.
  - Shut down the Microsoft® Windows® operating system and turn off the computer.
  - Prompt a user for an action (**Ask me what to do**).
- Select how the computer will respond when you press <Fn><Esc>.
  - Choose no action.
  - Enter standby mode.
  - Enter hibernate mode.
  - Shut down Microsoft Windows and turn off the computer.
  - Prompt a user for an action (**Ask me what to do**).

## Selecting a Power Scheme

 **NOTE:** When your computer is running on battery power, the **Network Disabled** power scheme disables your internal network and wireless activity. When your computer is connected to an electrical outlet, the **Network Disabled** power scheme disables only your wireless activity. You must set the power scheme through QuickSet (not Microsoft® Windows®) for **Network Disabled** to work.

The screen allows you to select, create, and edit power scheme settings. In addition, you can delete power schemes that you create, but you cannot delete Dell™ QuickSet predefined power schemes (**Maximum Battery**, **Maximum Performance**, **Presentation**, and **Network Disabled**).

 **NOTE:** QuickSet automatically adds the word (**QuickSet**) after the names of power schemes created using QuickSet.

All QuickSet power schemes are displayed in a drop-down menu near the center of the screen. The power settings for each scheme in the menu are listed below the menu. The power settings are listed separately for when the computer is running on battery or connected to an electrical outlet.

The **Power Management Wizard** also allows you to associate the display brightness level with a power scheme. You must enable brightness-level power schemes through QuickSet in order to set the brightness level.



The display brightness, internal network-card activity, and wireless activity features are not available through the Microsoft® Windows® **Control Panel** power schemes. In order to make use of these value-added features, you must set them through QuickSet power schemes.

 **NOTE:** Brightness shortcut keys only affect the display on your portable computer, not monitors that you attach to your portable computer or docking device. If your computer is in **CRT only** mode and you try to change the brightness level, the **Brightness Meter** appears, but the brightness level on the monitor does not change.

## Setting Battery Alarms and Actions

The screen allows you to enable the low-battery and critical-battery alarms and to change settings for the alarms. For example, you can set the low-battery alarm to 20 percent to remind you to save work and switch to AC power, and you can set the critical-battery alarm to 10 percent to enter hibernate mode. From the screen, you can:

- Select whether the alarm will notify you by sound or text.
- Adjust the power level at which you want the alarm to notify you.
- Select how the computer will respond when the alarm notifies you:
  - Choose no action.
  - Enter standby mode.
  - Enter hibernate mode.
  - Shut down Windows and turn off the computer.

## Completing the Power Management Wizard

The screen summarizes the QuickSet power scheme, sleep mode, and battery alarm settings for your computer. Review the settings you have selected and click **Finish**.

For more information about QuickSet, right-click the  icon in the taskbar and click **Help**.

---

## Power Management Modes

### Standby Mode

Standby mode conserves power by turning off the display and the hard drive after a predetermined period of inactivity (a time-out). When the computer exits standby mode, it returns to the same operating state it was in before entering standby mode.

 **NOTICE:** If your computer loses AC and battery power while in standby mode, it may lose data.

To enter standby mode:

- *In the Microsoft® Windows® XP operating system*, click the **Start** button, click **Turn off computer**,

and then click **Stand by**.

*In Windows 2000*, click the **Start** button, click **Shutdown**, click **Standby**, and then click **OK**.

or

- Depending on how you set the power management options on the [Advanced tab](#) in the **Power Options Properties** window, use one of the following methods:
  - Close the display.
  - Press <Fn><Esc>.

To exit standby mode, press the power button or open the display depending on how you set the options on the [Advanced tab](#). You cannot make the computer exit standby mode by pressing a key or touching the touch pad.

## Hibernate Mode

Hibernate mode conserves power by copying system data to a reserved area on the hard drive and then completely turning off the computer. When the computer exits hibernate mode, it returns to the same operating state it was in before entering hibernate mode.



**NOTICE:** You cannot remove devices or disconnect your computer from a docking device while your computer is in hibernate mode.

Your computer enters hibernate mode if the battery charge level becomes critically low.

To manually enter hibernate mode:

- *In Windows XP*, click the **Start** button, click **Turn off computer**, press and hold <Shift> key, and then click **Hibernate**.

*In Windows 2000*, if [hibernate support is enabled](#), click the **Start** button, click **Shutdown**, click **Hibernate**, and then click **OK**.

or

- Depending on how you set the power management options on the [Advanced tab](#) in the **Power Options Properties** window, use one of the following methods to enter hibernate mode:
  - Close the display.
  - Press <Fn><Esc>.



**NOTE:** Some PC Cards may not operate correctly after the computer exits hibernate mode. [Remove and reinsert the card](#), or simply restart (reboot) your computer.

To exit hibernate mode, press the power button. The computer may take a short time to exit hibernate mode. You cannot make the computer exit hibernate mode by pressing a key or touching the touch pad. For more information on hibernate mode, see the documentation that came with your operating system.

## Power Options Properties

The **Power Options Properties** window helps you to manage power consumption and monitor battery charge status. To access the Microsoft Windows **Power Options Properties** window:

- *In Windows XP*, click the **Start** button, click **Control Panel**, click **Performance and Maintenance**, and then click **Power Options**.
- *In Windows 2000*, open the Control Panel and double-click the **Power Options** icon.

## Power Schemes Tab

Windows XP controls the performance level of the processor depending on the power scheme you select. You do not need to make any further adjustments to set the performance level. For information on setting processor performance for other operating systems, see "[Intel SpeedStep™ Technology Tab \(for Windows 2000\)](#)."

Each preset power scheme has different time-out settings for entering standby mode, turning off the display, and turning off the hard drive. For more information on power management options, see the [Help and Support Center](#) (*Windows Help* in Windows 2000).

## Alarms Tab



**NOTE:** To enable audible alarms, click each **Alarm Action** button and select **Sound alarm**.

The **Low battery alarm** and **Critical battery alarm** settings alert you with a message when the battery charge falls below a certain percentage. When you receive your computer, the **Low battery alarm** and **Critical battery alarm** check boxes are selected. It is recommended that you continue to use these settings. See "[Using a Battery](#)" for more information on low-battery warnings.

## Power Meter Tab

The **Power Meter** tab displays the current power source and amount of battery charge remaining.

## Advanced Tab

The **Advanced** tab allows you to:

- Set power icon and [standby mode](#) password options.
- Program the following functions (depending on your operating system):
  - Prompt a user for an action (**Ask me what to do**).
  - Enter standby mode.
  - Enter [hibernate mode](#).
  - Shut down Windows and turn off the computer.
  - Choose no action (**None** or **Do nothing**).

To program these functions, click an option from the corresponding drop-down menu and then click **OK**.

## Hibernate Tab

The **Hibernate** tab lets you enable hibernate mode by clicking the **Enable hibernate support** check box.

## Intel SpeedStep™ Technology Tab (for Windows 2000)

 **NOTE:** Windows XP controls the performance level of the processor depending on the power scheme that you select. See "[Power Schemes Tab](#)."

 **NOTE:** To use Intel SpeedStep technology, a Windows operating system must be running.

Depending on your operating system and microprocessor, the **Power Options Properties** window includes the **Intel SpeedStep™ technology** tab. Intel SpeedStep technology allows you to set the performance level of the processor according to whether the computer is running on battery or AC power. Depending on your operating system, typical options are:

- **Automatic** — The processor runs at its highest possible speed (Maximum Performance mode) when the computer is running on AC power. When the computer is running on battery power, the processor runs in Battery Optimized mode.
- **Maximum Performance** — The processor runs at its highest possible speed even if the computer is running on battery power.
- **Battery Optimized Performance** — Processor speed is optimized for battery power even if the computer is connected to an electrical outlet.
- **Maximum Battery** — The processor runs at a slower speed to extend battery life.

To change additional Intel SpeedStep options:

1. Click **Advanced** and click one of the following options:
  - **Disable Intel SpeedStep technology control**
  - **Remove flag icon** (from the notification area)
  - **Disable audio notification when performance changes**
2. Click **OK** to accept any changes and click **OK** to close the **Intel SpeedStep™ technology** window.

You can also change the Intel SpeedStep settings by right-clicking the flag icon in the notification area.

# Using the Module Bay

- [About the Module Bay](#)
  - [Checking the Charge on the Second Battery](#)
  - [Removing and Installing Devices While the Computer Is Turned Off](#)
  - [Removing and Installing Devices While the Computer Is Running](#)
  - [Using CDs or DVDs](#)
- 

## About the Module Bay

 **CAUTION:** Before performing any of the following procedures, read and follow the safety instructions in the *System Information Guide*.

You can install devices such as a floppy drive, CD drive, CD-RW drive, DVD drive, CD-RW/DVD drive, DVD+RW, second battery, or second hard drive in the module bay.

 **NOTE:** You do not need to install the device screw unless you want to secure the module inside the computer for security purposes.

Your Dell™ computer ships with an optical drive installed in the module bay. However, the device screw is not installed in the optical drive but packaged separately. When you install your device in the module bay, you can install the device screw.

---

## Checking the Charge on the Second Battery

Before you install a second battery, press the status button on the battery charge gauge to illuminate the charge level lights. Each light represents approximately 20 percent of the total battery charge. For example, if the battery has 80 percent of its charge remaining, four of the lights are on. If no lights appear, the battery has no charge.

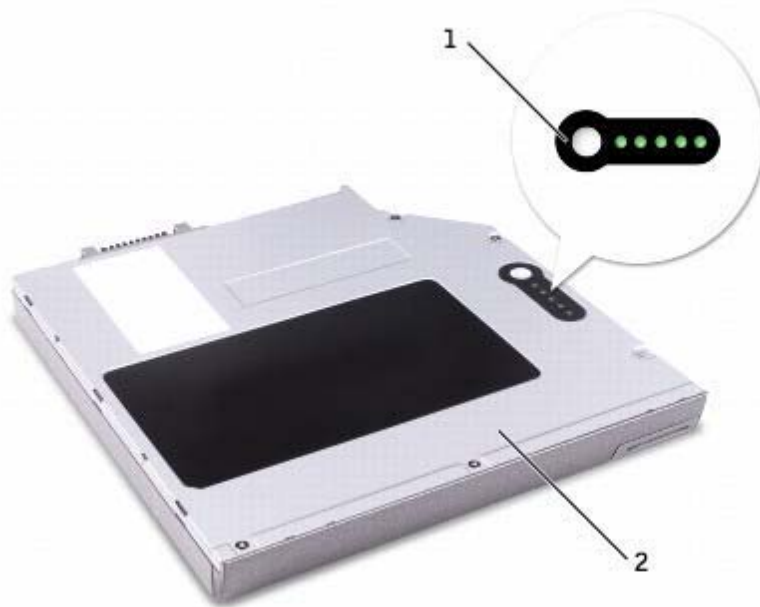

1	status button on the battery charge gauge
2	second battery (bottom)

## Removing and Installing Devices While the Computer Is Turned Off

**⚠ CAUTION:** Before performing any of the following procedures, read and follow the safety instructions in the *System Information Guide*.

**🔧 NOTE:** If the device screw is not installed, you can [remove and install devices while the computer is running](#) and connected to a docking device (docked).

Your computer ships with an optical drive installed in the module bay. However, the device screw is not installed in the optical drive but packaged separately. When you install your device in the module bay, you can install the device screw.

**🔧 NOTE:** You do not need to install the device screw unless you want to secure the module inside the computer for security purposes.

### If the Device Screw Is Not Installed

**➡ NOTICE:** To prevent damage to devices, place them in a safe, dry place when they are not installed in the computer. Avoid pressing down on them or placing heavy objects on top of them.

1. Press the device latch release so that the latch release pops out.



1	device latch release
---	----------------------

2. Pull the device by the latch release to remove the device from the module bay.



3. Insert the new device into the bay, push the device until you feel a click, and push the device latch release in so that it is flush with the computer.

## If the Device Screw Is Installed

1. Save and close any open files, exit any open programs, and then shut down the computer.
2. If the computer is connected to a docking device (docked), undock it. See the documentation that came with your docking device for instructions.

**➔ NOTICE:** To prevent damage to devices, place them in a safe, dry place when they are not installed in the computer. Avoid pressing down on them or placing heavy objects on top of them.

3. Close the display and turn the computer over.
4. Use a #1 Phillips screwdriver to remove the device screw from the bottom of the computer.



1	device latch release
---	----------------------

5. Press the device latch release so that the latch release pops out.
6. Pull the device by the latch release to remove the device from the module bay.



7. Insert the new device into the bay, push the device until you feel a click, and push the device latch release in so that it is flush with the computer.
8. Replace the device screw.
9. Turn on the computer.



## Removing and Installing Devices While the Computer Is Running

**⚠ CAUTION:** Before performing any of the following procedures, read and follow the safety instructions in the *System Information Guide*.

Your computer ships with an optical drive installed in the module bay. However, the device screw is not installed in the optical drive but packaged separately. When you install your device in the module bay, you can install the device screw.

**🔩 NOTE:** You do not need to install the device screw unless you want to secure the module inside the computer for security purposes.

### If the Device Screw Is Not Installed

#### Microsoft® Windows® XP

1. Double-click the **Safely Remove Hardware** icon on the taskbar.
2. Click **Stop** and wait for the operating system to confirm that the device has stopped.
3. Click the device you want to eject.

**➡ NOTICE:** To prevent damage to devices, place them in a safe, dry place when they are not installed in the computer. Avoid pressing down on them or placing heavy objects on top of them.

4. Press the device latch release so that the latch release pops out.



1	device latch release
---	----------------------

5. Pull the device by the latch release to remove the device from the module bay.



6. Insert the new device into the bay, push the device until you feel a click, and push the device latch release in so that it is flush with the computer. Windows XP automatically recognizes the new device.
7. If necessary, enter your password to unlock your computer.

## Windows 2000

1. Click the **Unplug or Eject Hardware** icon on the taskbar.
2. Click the device you want to eject and click **Stop**.
3. Press the device latch release so that the latch release pops out.



1	device latch release
---	----------------------

4. Pull the device by the latch release to remove the device from the module bay.



5. Insert the new device into the bay, push the device until you feel a click, and push the device latch release in so that it is flush with the computer.
6. When the operating system recognizes the new device, click **Close**.

## If the Device Screw Is Installed

### Windows XP

1. Double-click the **Safely Remove Hardware** icon on the taskbar.
2. Click the device you want to eject.
3. If the computer is connected to a docking device (docked), undock it. See the documentation that came with your docking device for instructions.

➔ **NOTICE:** To prevent damage to devices, place them in a safe, dry place when they are not installed in the computer. Avoid pressing down on them or placing heavy objects on top of them.

4. Use a #1 Phillips screwdriver to remove the device screw from the bottom of the computer.



1	device latch release
---	----------------------

5. Press the device latch release so that the latch release pops out.
6. Pull the device by the latch release to remove the device from the module bay.



7. Insert the new device into the bay, push the device until you feel a click, and push the device latch release in so that it is flush with the computer. Windows XP automatically recognizes the new device.
8. If necessary, enter your password to unlock your computer.

## Windows 2000

1. Click the **Unplug or Eject Hardware** icon on the taskbar.
2. Click the device you want to eject and click **Stop**.
3. If the computer is connected to a docking device (docked), undock it. See the documentation that came with your docking device for instructions.

4. Use a #1 Phillips screwdriver to remove the device screw from the bottom of the computer.



1	device latch release
---	----------------------

5. Press the device latch release so that the latch release pops out.
6. Pull the device by the latch release to remove the device from the module bay.



7. Insert the new device into the bay, push the device until you feel a click, and push the device latch release in so that it is flush with the computer.
8. When the operating system recognizes the new device, click **Close**.

---

## Using CDs or DVDs

## Using the CD or DVD Tray

➡ **NOTICE:** Do not press down on the drive tray when opening or closing it. Keep the tray closed when you are not using the drive.

➡ **NOTICE:** Do not move the computer while playing CDs or DVDs.

1. Press the eject button on the front of the drive.
2. Pull the tray out.
3. Place the disc, label side up, in the center of the tray.

➡ **NOTICE:** Ensure that you snap the disc onto the spindle. Otherwise you may damage the drive tray, or your CD or DVD will not work properly.

4. Snap the disc onto the spindle.



1	eject button
---	--------------

5. Push the tray back into the drive.

📎 **NOTE:** If you use a module that shipped with another computer, you need to install the drivers and software necessary to play DVDs or write data. For more information, see the *Drivers and Utilities CD*.

You can play a DVD on your computer if the computer shipped with a DVD drive or a CD-RW/DVD combo drive. You can write data to a CD-R/CD-RW on your computer if the computer shipped with a CD-RW or CD-RW/DVD combo drive.

For more information on playing CDs or DVDs, click **Help** on the CD player or DVD player (if available).

## Adjusting the Volume

 **NOTE:** If the speakers are muted, you do not hear the CD or DVD playing.

1. Click the **Start** button, point to **All Programs**→ **Accessories**→ **Entertainment** (or **Multimedia**), and then click **Volume Control**.
2. In the **Volume Control** window, click and drag the bar in the **Volume Control** column and slide the bar up or down to increase or decrease the volume.

For more information on volume control options, click **Help** in the **Volume Control** window.

The **Volume Meter** displays the current volume level, including mute, on your computer. Either right-click the  icon in the taskbar or press the volume control buttons to enable or disable the **Volume Meter** on the screen.

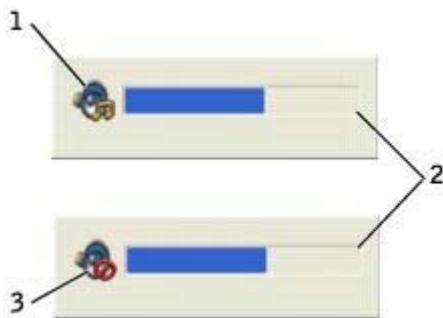

1	volume icon
2	<b>Volume Meter</b>
3	mute icon

 **NOTE:** By default, the **Volume Meter** appears in the lower-right corner of the display. You can click and drag the meter to a new location, and the meter subsequently always appears at the new location.

When the meter is enabled, adjust the volume using the volume control buttons or by pressing the following keys:

- Press <Fn><Page Up> to increase volume.
- Press <Fn><Page Down> to decrease volume.
- Press <Fn><End> to mute volume.

For more information about QuickSet, right-click the  icon in the taskbar, and click **Help**.

## Adjusting the Picture

If an error message notifies you that the current resolution and color depth are using too much memory and preventing DVD playback, adjust the display properties.

## Windows XP

1. Click the **Start** button and click **Control Panel**.
2. Under **Pick a category**, click **Appearance and Themes**.
3. Under **Pick a task...**, click **Change the screen resolution**.
4. In the **Display Properties** window, click and drag the bar in **Screen resolution** to change the setting to **1024 by 768 pixels**.
5. Under **Color quality**, click the drop-down menu and click **Medium (16 bit)**.
6. Click **OK**.

## Windows 2000

1. Click the **Start** button, point to **Settings**, and then click **Control Panel**.
2. Double-click the **Display** icon and click the **Settings** tab.
3. Click and drag the bar in **Screen area** to change the setting to **1024 by 768 pixels**.
4. Under **Color quality**, click the drop-down menu and click **High Color (16 bit)**.
5. Click **Apply**.
6. Click **OK** to save the settings and close the window.



# Using a Battery

- [Battery Performance](#)
  - [Checking the Battery Charge](#)
  - [Charging the Battery](#)
  - [Removing a Battery](#)
  - [Removing and Installing a Reserve Battery](#)
  - [Installing a Battery](#)
  - [Storing a Battery](#)
- 

## Battery Performance

 **NOTE:** Batteries for portable computers are covered under warranty only during the initial 1-year period of the limited warranty for the computer. For more information about the Dell warranty for the computer, see the *System Information Guide* or separate paper warranty document that shipped with your computer.

For optimal computer performance and to help preserve BIOS settings, operate your Dell™ portable computer with the main battery installed at all times. Use a battery to run the computer when the computer is not connected to an electrical outlet. One battery is supplied as standard equipment in the battery bay.

 **NOTE:** For more information on maximizing battery operating time, see "[Power Management](#)."

Battery operating time varies depending on operating conditions. With average usage, you may expect from 3 to 4 hours from a single, fully charged battery. You can install an optional second battery in the module bay to significantly increase operating time. For more information about the second battery, see "[Using the Module Bay](#)."

 **NOTE:** It is recommended that you connect your computer to an electrical outlet when writing to a CD.

Operating time is significantly reduced when you perform operations including, but not limited to, the following:

- Using optical drives, especially DVD and CD-RW drives
- Using wireless communications devices, PC Cards, or USB devices
- Using high-brightness display settings, 3D screen savers, or other power-intensive programs, such as 3D games
- Running the computer in [maximum performance mode](#)

You can [check the battery charge](#) on the bottom of the computer. You can also set power management options to alert you when the [battery charge is low](#).

 **CAUTION:** Using an incompatible battery may increase the risk of fire or explosion. Replace the battery only with a compatible battery purchased from Dell. The lithium-ion battery is designed to work with your Dell™ computer. Do not use a battery from other computers with your computer.

 **CAUTION:** Do not dispose of batteries with household waste. When your battery no longer holds a charge, call your local waste disposal or environmental agency for advice on disposing of a lithium-ion battery. See the battery disposal instructions in your *System Information Guide*.

 **CAUTION:** Misuse of the battery may increase the risk of fire or chemical burn. Do not puncture, incinerate, disassemble, or expose the battery to temperatures above 65°C (149°F). Keep the battery away from children. Handle damaged or leaking batteries with extreme care. Damaged batteries may leak and cause personal injury or equipment damage.

## Checking the Battery Charge

The Dell QuickSet battery meter, Microsoft® Windows® power meter window and  icon, the battery charge gauge and health gauge, and the low-battery warning provide information on the battery charge.



For more information about checking the charge on the second battery, see "[Using the Module Bay](#)."

### Dell QuickSet Battery Meter

Press <Fn><F3> to display the QuickSet **Battery Meter**.

The **Battery Meter** screen displays status, charge level, and charge completion time for the primary and second batteries in your computer.

The following icons appear in the **Battery Meter** screen:

	<ul style="list-style-type: none"> <li>• The computer is running on battery power.</li> <li>• The battery is discharging or idle.</li> </ul>
	<ul style="list-style-type: none"> <li>• The computer is connected to an electrical outlet and running on AC power.</li> <li>• The battery is charging.</li> </ul>
	<ul style="list-style-type: none"> <li>• The computer is connected to an electrical outlet and running on AC power.</li> <li>• The battery is discharging, idle, or charging.</li> </ul>

For more information about QuickSet, right-click the  icon in the taskbar, and click **Help**.

### Microsoft Windows Power Meter

The Windows power meter indicates the remaining battery charge. To check the power meter, double-click the  icon on the taskbar. For more information on the **Power Meter** tab, see "[Power Management](#)."

If the computer is connected to an electrical outlet, a  icon appears.

## Charge Gauge

Press the status button on the battery charge gauge to illuminate the charge-level lights. Each light represents approximately 20 percent of the total battery charge. For example, if the battery has 80 percent of its charge remaining, four of the lights are on. If no lights appear, the battery has no charge.



## Health Gauge

The battery operating time is largely determined by the number of times it is charged. After hundreds of charge and discharge cycles, batteries lose some charge capacity, or battery health. To check the battery health, press and hold the status button on the battery charge gauge for at least 3 seconds. If no lights appear, the battery is in good condition, and more than 80 percent of its original charge capacity remains. Each light represents incremental degradation. If five lights appear, less than 60 percent of the charge capacity remains, and you should consider replacing the battery. See "[Specifications](#)" for more information about the battery operating time.

## Low-Battery Warning

- 🔊 **NOTICE:** To avoid losing or corrupting data, save your work immediately after a low-battery warning. Then connect the computer to an electrical outlet, or install a second battery in the module bay. If the battery runs completely out of power, hibernate mode begins automatically.

A low-battery warning occurs when the battery charge is approximately 90 percent depleted. The computer beeps once, indicating that minimal battery operating time remains. During that time, the speaker beeps periodically. If two batteries are installed, the low-battery warning means that the combined charge of both batteries is approximately 90 percent depleted. The computer enters hibernate mode when the battery charge is at a critically low level. For more information on low-battery alarms, see "[Power Management](#)."

---

## Charging the Battery

- 🔌 **NOTE:** The AC adapter charges a completely discharged battery in approximately 1 hour with the

computer turned off. Charge time is longer with the computer turned on. You can leave the battery in the computer as long as you like. The battery internal circuitry prevents the battery from overcharging.

When you connect the computer to an electrical outlet or install a battery while the computer is connected to an electrical outlet, the computer checks the battery charge and temperature. If necessary, the AC adapter then charges the battery and maintains the battery charge.

If the battery is hot from being used in your computer or being in a hot environment, the battery may not charge when you connect the computer to an electrical outlet.

Disconnect the computer from the electrical outlet and allow the computer and the battery to cool to room temperature. Then connect the computer to an electrical outlet to continue charging the battery.

For more information on resolving problems with a battery, see "[Power Problems](#)."

---

## Removing a Battery

 **CAUTION:** Before performing the following procedures, read and follow the safety instructions in the *System Information Guide*.

For more information about removing the second battery, see "[Using the Module Bay](#)."

 **CAUTION:** Before performing these procedures, turn off the computer, disconnect it from the electrical outlet, and disconnect the modem from the telephone wall jack.

 **NOTICE:** If you choose to replace the battery with the computer in [standby mode](#), you have up to 90 seconds to complete the battery replacement before the computer shuts down and loses any unsaved data.

1. Ensure that the computer is turned off, disconnected from an electrical outlet, and disconnected from the telephone wall jack.
2. If the computer is connected to a docking device (docked), undock it. See the documentation that came with your docking device for instructions.
3. Slide and hold the battery-bay latch release on the bottom of the computer, and then remove the battery from the bay.



---

## Removing and Installing a Reserve Battery

**⚠ CAUTION:** Before performing the following procedures, read and follow the safety instructions in the *System Information Guide*.

1. [Remove the battery.](#)
2. Remove the reserve battery cover.



3. Pull the reserve battery out of its compartment, and disconnect the reserve battery cable from the connector.

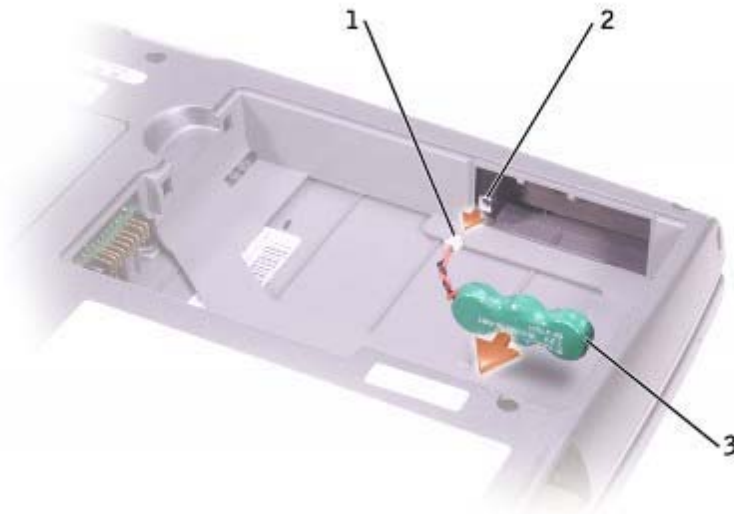

1	reserve battery cable
2	connector
3	reserve battery

4. Connect the reserve battery cable to the connector in the reserve battery compartment.
5. Place the reserve battery in the compartment, and replace the reserve battery cover.



---

## Installing a Battery

**⚠ CAUTION:** Before performing the following procedures, read and follow the safety instructions in the *System Information Guide*.

Slide the battery into the bay until the latch release clicks.

For more information about installing the second battery, see "[Using the Module Bay](#)."

---

## Storing a Battery

Remove the battery when you store your computer for an extended period of time. A battery discharges during prolonged storage. After a long storage period, [recharge the battery](#) fully before you use it.

# Using the Display

- [Adjusting Brightness](#)
  - [Switching the Video Image](#)
  - [Setting Display Resolution](#)
- 

## Adjusting Brightness

When the Dell™ computer is running on battery power, you can conserve power by setting the brightness to the lowest comfortable setting using the appropriate [keyboard shortcuts for the display](#).

The Dell QuickSet **Brightness Meter** shows the current brightness setting for the display. Right-click the  icon in the taskbar to enable or disable the **Brightness Meter** on the screen.

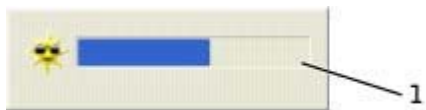

1	<b>Brightness Meter</b>
---	-------------------------

- ✎ **NOTE:** By default, the **Brightness Meter** appears in the lower-right corner of the display. You can click and drag the meter to a new location, and the meter subsequently always appears at the new location.
- ✎ **NOTE:** Brightness keyboard shortcuts only affect the display on your portable computer, not monitors that you attach to your portable computer or docking device. If your computer is in **CRT only** mode and you try to change the brightness level, the **Brightness Meter** appears, but the brightness level on the monitor does not change.

You can enable or disable the **Brightness Meter** from the QuickSet taskbar menu. When the meter is enabled, press the following keys to adjust brightness:

- Press <Fn> up-arrow key to increase brightness on the integrated display only (not on an external monitor).
- Press <Fn> down-arrow key to decrease brightness on the integrated display only (not on an external monitor).

For more information about QuickSet, right-click the  icon in the taskbar and click **Help**.

---

## Switching the Video Image



When you start the computer with an external device (such as an external monitor or projector) attached and turned on, the image may appear on either the display or the external device.

Press <Fn><F8> to switch the video image to the integrated display only, the integrated display and an external CRT monitor simultaneously, an external CRT monitor only, the integrated display and external DVI monitor simultaneously, and external DVI monitor only.

 **NOTE:** : You cannot use <Fn><F8> to switch the video image between the integrated display and an external S-Video device.

---

## Setting Display Resolution

To display a program at a specific resolution, both the video controller and the display must support the program, and the necessary [video drivers must be installed](#).

Before you change any of the default display settings, make a note of the default settings for future reference.

 **NOTE:** Use only the Dell-installed video drivers, which are designed to offer the best performance with your Dell-installed operating system.

If you choose a resolution or color palette that is higher than the display supports, the settings adjust automatically to the closest possible setting.

 **NOTE:** As the resolution increases, icons and text appear smaller on the screen.

If the video resolution setting is higher than that supported by the display, the computer enters *pan mode*. In pan mode, the screen cannot be completely displayed. For example, the taskbar that usually appears at the bottom of the desktop may no longer be visible. To view the rest of the screen, use the touch pad to pan up, down, left, and right.

 **NOTICE:** You can damage an external monitor by using an unsupported refresh rate. Before adjusting the refresh rate on an external monitor, see the monitor user's guide.

## Microsoft® Windows® XP

1. Click the **Start** button and click **Control Panel**.
2. Under **Pick a category**, click **Appearance and Themes**.
3. Under **Pick a task...**, click the area you want to change, or under **or pick a Control Panel icon**, click **Display**.
4. Try different settings for **Color quality** and **Screen resolution**.

## Windows 2000

1. Click the **Start** button, point to **Settings**, and then click **Control Panel**.
2. Double-click the **Display** icon and click the **Settings** tab.
3. Try different settings for **Colors** and **Screen area**.



# Using the Keyboard and Touch Pad

- [Numeric Keypad](#)
  - [Keyboard Shortcuts](#)
  - [Touch Pad](#)
  - [Customizing the Touch Pad](#)
- 

## Numeric Keypad







 **NOTE:** When you connect an external keyboard or keypad to the computer, the keypad is disabled.

The numeric keypad functions like the numeric keypad on an external keyboard. Each key on the keypad has multiple functions. The keypad numbers and symbols are marked in blue on the right of the keypad keys. To type a number or symbol, enable the keypad, hold down <Fn> and press the desired key.

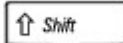

- To enable the keypad, press <Num Lk>. The  light indicates that the keypad is active.
  - To disable the keypad, press <Num Lk> again.
- 

## Keyboard Shortcuts



### System Functions

  	Opens the <b>Windows Task Manager</b> window
	Enables and disables the numeric keypad (on an external keyboard only)
 	Enables and disables the scroll lock







## Battery

 	Displays the <a href="#">Dell™ QuickSet Battery Meter</a> .
---	---



## CD or DVD Tray

 	Ejects the tray out of the drive.
---	-----------------------------------



## Display Functions

 	Switches the video image to the next display in the following sequence: the integrated display only, the integrated display and an external CRT monitor simultaneously, an external CRT monitor only, the integrated display and an external DVI monitor simultaneously, and an external DVI monitor only.
 	Increases brightness on the integrated display only (not on an external monitor)
 	Decreases brightness on the integrated display only (not on an external monitor)

## Radios (Including Wireless Networking and Bluetooth™)



 	Enables and disables radios, including wireless networking and Bluetooth.
---	---





## Power Management

 	Activates the power management mode of your choice. You can program this keyboard shortcut on the <a href="#">Advanced tab</a> in the <b>Power Options Properties</b> window.
---	---

















## Speaker Functions

If no sound comes from the speakers, press <Fn><End> and adjust the volume.

 	Increases the volume of the integrated speakers and external speakers, if attached
---	--

 	Decreases the volume of the integrated speakers and external speakers, if attached
 	Enables and disables the integrated speakers and external speakers, if attached

## Microsoft® Windows® Logo Key Functions

 	Minimizes all open windows
  	Maximizes all windows
 	Runs Windows Explorer
 	Opens the <b>Run</b> dialog box
 	Opens the <b>Search Results</b> dialog box
  	Opens the <b>Search Results-Computer</b> dialog box (if the computer is connected to a network)
 	Opens the <b>System Properties</b> dialog box

To adjust keyboard operation, such as the character repeat rate, open the Control Panel, and click **Printers and Other Hardware** (*for Windows XP*) or double-click the **Keyboard** icon (*for Windows 2000*).

## Touch Pad

The touch pad detects the pressure and movement of your finger to allow you to move the cursor on the display. Use the touch pad and touch pad buttons as you would use a mouse.

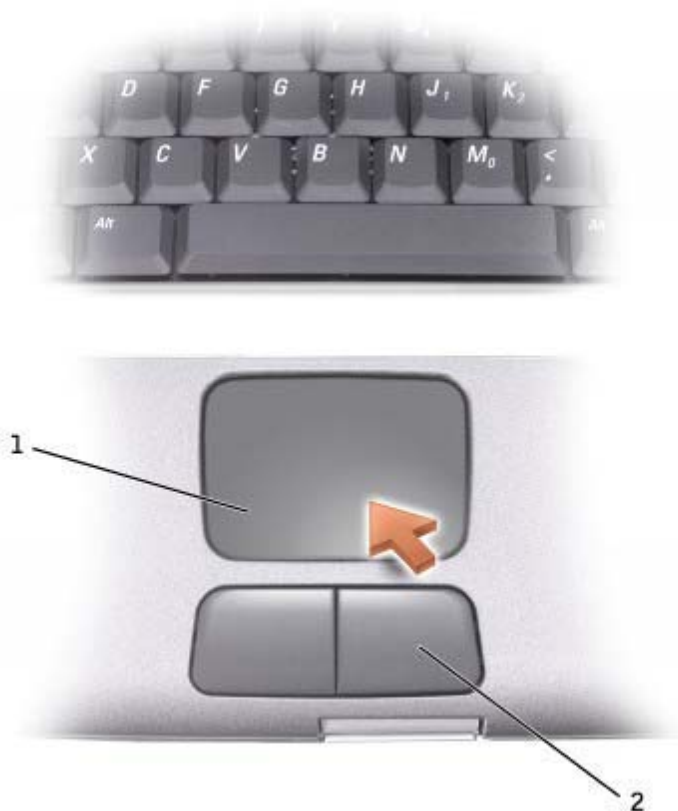

1	touch pad
2	touch pad buttons

- To move the cursor, lightly slide your finger over the touch pad.
- To select an object, lightly tap once on the surface of the touch pad or use your thumb to press the left touch-pad button.
- To select and move (or drag) an object, position the cursor on the object and tap down-up-down on the touch pad. On the second down motion, leave your finger on the touch pad and move the selected object by sliding your finger across the surface.
- To double-click an object, position the cursor on the object and then tap twice on the touch pad, or use your thumb to press the left touch-pad button twice.

---

## Customizing the Touch Pad

You can disable the touch pad or adjust its settings by using the **Mouse Properties** window.

1. *In Windows XP*, open the Control Panel, click **Printers and Other Hardware**, and then click **Mouse**.

*In Windows 2000*, open the Control Panel and double-click the **Mouse** icon.

2. On the **Mouse Properties** window:
  - Click the **Device Select** tab to disable the touch pad.
  - Click the **Pointer** tab to adjust touch pad settings.
3. Select the desired settings and click **Apply**.
4. Click **OK** to save the settings and close the window.

# Dell™ QuickSet Features

- [Clicking the QuickSet Icon](#)
- [Double-Clicking the QuickSet Icon](#)
- [Right-Clicking the QuickSet Icon](#)

Dell™ QuickSet runs from the  icon located in the taskbar and functions differently when you click, double-click, or right-click the icon.

---

## Clicking the QuickSet Icon

Click the  icon to perform the following tasks:

- Adjust power management settings using the [Power Management Wizard](#).
  - Adjust the size of icons and toolbars.
  - Select a power scheme that you set in the [Power Management Wizard](#).
  - Turn presentation mode on or off.
- 

## Double-Clicking the QuickSet Icon

Double-click the  icon to adjust power management settings using the [Power Management Wizard](#).

---

## Right-Clicking the QuickSet Icon

Right-click the  icon to perform the following tasks:

- Enable or disable the [Brightness Meter](#) on the screen.
- Enable or disable the [Volume Meter](#) on the screen.
- Turn [wireless activity](#) on or off.
- View *Dell QuickSet Help*.
- View the version and copyright date of the QuickSet program installed on your computer.



For more information about QuickSet, right-click the  icon in the taskbar and click **Help**.

# About Microsoft® Windows® XP

- [Help and Support Center](#)
  - [Switching to Classic View](#)
  - [Desktop Cleanup Wizard](#)
  - [Files and Settings Transfer Wizard](#)
  - [Program Compatibility Wizard](#)
  - [User Accounts and Fast User Switching](#)
  - [Home and Small Office Networking](#)
  - [Internet Connection Firewall](#)
- 

## Help and Support Center

The Help and Support Center provides help with the Windows XP operating system and other support and educational tools. To access the Help and Support Center, click the **Start** button and click **Help and Support**.

---

## Switching to Classic View

You may change the appearance of the Control Panel, the **Start** menu, and the Windows desktop to the *classic view* of earlier Windows operating systems.

### Control Panel

The Control Panel presents information as task-oriented categories. If you are accustomed to performing a particular task with the icon-oriented classic Control Panel, you can switch to the classic icon view:

1. Click the **Start** button and click **Control Panel**.
2. Click **Switch to Classic View** or **Switch to Category View** in the upper-left area of the **Control Panel** window.

### Start Menu

1. Right-click the empty area on the taskbar.
2. Click **Properties**.
3. Click the **Start Menu** tab.

4. Select **Classic Start Menu** and click **OK**.

## Window and Button Appearance

1. Right-click anywhere on the main desktop screen and click **Properties**.
  2. Click the **Appearance** tab.
  3. From the **Windows and buttons** drop-down menu, select **Windows Classic style**.
  4. To customize color, font, and other classic desktop options, click **Advanced**.
  5. When you have completed your appearance selections, click **OK**.
- 

## Desktop Cleanup Wizard

By default, the Desktop Cleanup Wizard moves programs that are not frequently used to a designated folder 7 days after you first start your computer and every 60 days after that. The appearance of the **Start** menu changes as programs are moved.

To turn off the Desktop Cleanup Wizard:

1. Right-click an empty spot on the desktop, and click **Properties**.
2. Click the **Desktop** tab and click **Customize Desktop**.
3. Click **Run Desktop Cleanup Wizard every 60 days** to remove the check mark.
4. Click **OK**.

To run the Desktop Cleanup Wizard at any time:

1. Right-click an empty spot on the desktop, and click **Properties**.
  2. Click the **Desktop** tab and click **Customize Desktop**.
  3. Click **Clean Desktop Now**.
  4. When the Desktop Cleanup Wizard appears, click **Next**.
  5. In the list of shortcuts, deselect any shortcuts you want to leave on the desktop, and then click **Next**.
  6. Click **Finish** to remove the shortcuts and close the wizard.
- 

## Files and Settings Transfer Wizard

The Files and Settings Transfer Wizard allows you to transfer files and settings from one computer to another (for instance, when upgrading to a new computer), even if the old computer is running an earlier operating system. The time required to collect and transfer data depends on the amount of data collected. Times can vary from just a few minutes to several hours.

You can transfer the data to the new computer over a network or direct serial connection, or you can store it on a removable medium such as a floppy disk or writable CD. If a CD drive is not available, the wizard allows you to create a wizard disk to run on your old computer.

For more information, see the [Help and Support Center](#).

---

## Program Compatibility Wizard

If you encounter problems running a program designed for an earlier Windows operating system, you can use the Program Compatibility Wizard to help resolve the problem. The Program Compatibility Wizard allows you to configure a program to run in an environment closer to that of Windows 95, Windows 98, Windows Millennium Edition (Me), Windows NT® 4.0 with Service Pack 5, or Windows 2000.

If you experience problems with your operating system or other programs after performing an installation, you can use the [system restore](#) feature to return your computer to a previous stable condition.

For more information, see the [Help and Support Center](#).

---

## User Accounts and Fast User Switching

Fast User Switching allows multiple users to access the computer. After you log on to the computer with your specific settings, including the desktop and various programs, other users can log on to the computer without requiring you to first log off. New users log on and switch from your session to their own. New users can run their desktop and programs without interfering with yours. You can switch back to your desktop and programs with the original settings. For more information, see the [Help and Support Center](#).

## Special Considerations With Fast User Switching

- Computers with low memory configurations can experience problems. The computer uses memory to keep your programs running in the background while a second user is logged on, which can cause the computer to run slowly. Fast User Switching is off by default on computers with less than 128 MB of RAM.
  - Fast User Switching is disabled in Windows XP Professional when the computer is a member of a computer domain.
- 

## Home and Small Office Networking

The Network Setup Wizard provides online documentation and support for setting up a home or small office network. The new wizard automatically enables the personal firewall (see "[Internet Connection Firewall](#)").

The Network Setup Wizard includes a checklist and steps to guide you through the process of sharing resources, such as files, printers, or an Internet connection, between computers in a home or small office. For more information, see the [Help and Support Center](#).

---

## Internet Connection Firewall

The Internet Connection Firewall provides basic protection from unauthorized access to the computer while the computer is connected to the Internet. The firewall is automatically enabled when you run the Network Setup Wizard. When the firewall is enabled for a network connection, the firewall icon appears with a red background in the **Network Connections** portion of the Control Panel.

Note that enabling the Internet Connection Firewall does not reduce the need for virus-checking software.

For more information, see the [Help and Support Center](#).

# About Your Computer

- [Front View](#)
  - [Left View](#)
  - [Right View](#)
  - [Back View](#)
  - [Bottom View](#)
- 

## Front View

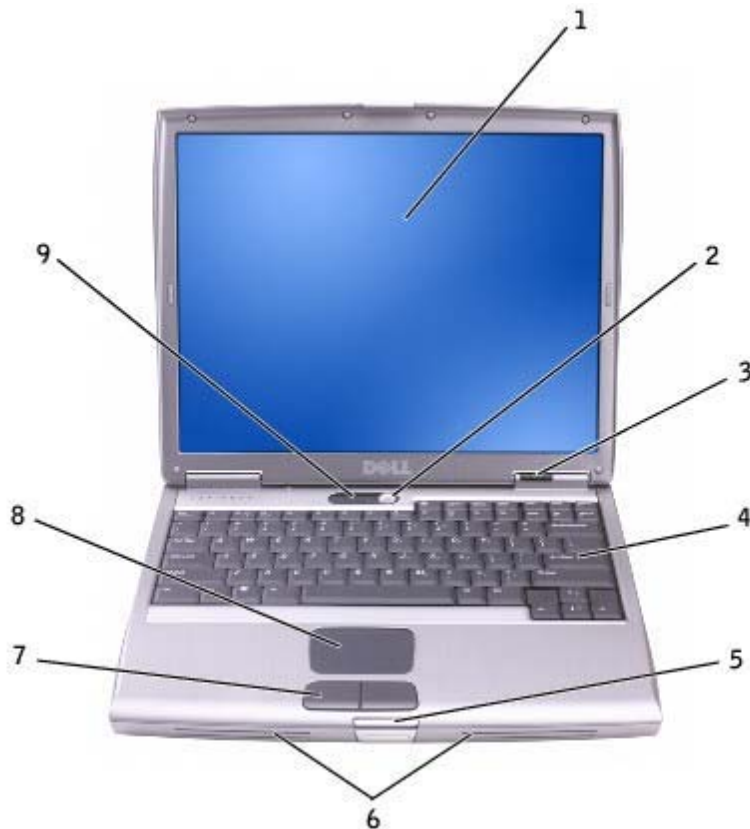

1	<a href="#">display</a>	6	<a href="#">speakers</a>
2	<a href="#">power button</a>	7	<a href="#">touch pad buttons</a>
3	<a href="#">device status lights</a>	8	<a href="#">touch pad</a>
4	<a href="#">keyboard</a>	9	<a href="#">keyboard status lights</a>
5	<a href="#">display latch</a>		

**display** — For more information about your display, see "[Using the Display](#)."







**power button** — Press the power button to turn on the computer or exit a [power management mode](#).

- ➔ **NOTICE:** To avoid losing data, turn off your computer by performing a Microsoft® Windows® operating system shutdown rather than by pressing the power button.

If the computer stops responding, press and hold the power button until the computer turns off completely (which may take several seconds).

### device status lights



	Turns on when you turn on the computer and blinks when the computer is in a power management mode.
	Turns on when the computer reads or writes data.  ➔ <b>NOTICE:</b> To avoid loss of data, never turn off the computer while the  light is flashing.
	Turns on steadily or blinks to indicate battery charge status.
	Turns on when Bluetooth™ is enabled. To enable or disable Bluetooth, press <Fn><F2>.  <b>NOTE:</b> Bluetooth is an optional feature on your computer, so the  icon turns on only if you ordered Bluetooth with your computer. For more information, see the documentation that came with your Bluetooth wireless technology.

If the computer is connected to an electrical outlet, the  light operates as follows:

- Solid green: The battery is charging.
- Flashing green: The battery is almost fully charged.

If the computer is running on a battery, the  light operates as follows:

- Off: The battery is adequately charged (or the computer is turned off).
- Flashing orange: The battery charge is low.

Solid orange: The battery charge is critically low.

**keyboard** — The keyboard includes a numeric keypad as well as the Windows logo key . For information on supported keyboard shortcuts, see "[Using the Keyboard and Touch Pad](#)."

**display latch** — Keeps the display closed.

**speakers** — To adjust the volume of the integrated speakers, press the volume control buttons, mute button, or volume-control keyboard shortcuts. For more information, see "[Using the Keyboard and Touch Pad](#)."



**touch pad buttons** — Provide the functionality of a mouse. See "[Using the Keyboard and Touch Pad](#)" for more information.

**touch pad** — Provides the functionality of a mouse. See "[Using the Keyboard and Touch Pad](#)" for more information.

### keyboard status lights



The green lights located above the keyboard indicate the following:

	Turns on when the numeric keypad is enabled.
	Turns on when the uppercase letter function is enabled.
	Turns on when the scroll lock function is enabled.





## Left View



1	<a href="#">air vents</a> (2)	4	<a href="#">infrared sensor</a>
2	<a href="#">IEEE 1394 connector</a>	5	<a href="#">audio connectors</a> (2)
3	<a href="#">PC Card slot</a>	6	<a href="#">security cable slot</a>

**air vents** — The computer uses an internal fan to create airflow through the vents, which prevents the computer from overheating.

 **NOTE:** The computer turns on the fan when the computer gets hot. Fan noise is normal and does not indicate a problem with the fans or the computer.

 **CAUTION:** Do not block, push objects into, or allow dust to accumulate in the air vents. Do not store your Dell™ computer in a low-airflow environment, such as a closed briefcase, while it is running. Restricting the airflow can damage the computer or cause a fire.

**PC Card slot** — Supports one PC Card, such as a modem or network adapter. For more information, see "[Using PC Cards](#)."

**infrared sensor** — Lets you transfer files from your computer to another infrared-compatible device without using cable connections.

### IEEE 1394 connector —

Use to attach devices supporting IEEE 1394 high-speed transfer rates, such as some digital video cameras.

When you receive your computer, the sensor is disabled. You can use the [system setup program](#) to enable the sensor. For information on transferring data, see Windows *Help*, the [Help and Support Center](#), or the documentation that came with your infrared-compatible device.

### audio connectors

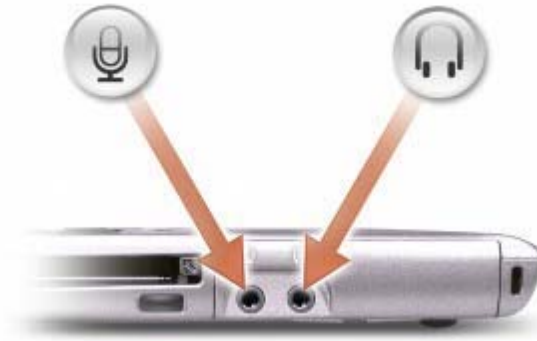

Attach a microphone to the  connector.

Attach headphones or speakers to the  connector.

**security cable slot** — Lets you attach a commercially available antitheft device to the computer. For more information, see the instructions included with the device.

 **NOTICE:** Before you buy an antitheft device, ensure that it will work with the security cable slot.



---

## Right View



1	<a href="#">security cable slot</a>
2	<a href="#">module bay</a>
3	<a href="#">device latch release</a>

**security cable slot** — Lets you attach a commercially available antitheft device to the computer. For more information, see the instructions included with the device.

 **NOTICE:** Before you buy an antitheft device, ensure that it will work with the security cable slot.



**module bay** — You can install devices such as an optical drive or a Dell Travellite™ module in the module bay. For more information, see "[Using the Module Bay](#)."

**device latch release** — Releases the module bay device. See "[Using the Module Bay](#)" for instructions.

---

## Back View

**⚠ CAUTION:** Do not block, push objects into, or allow dust to accumulate in the air vents. Do not store your computer in a low-airflow environment, such as a closed briefcase, while it is running. Restricting the airflow can damage the computer or cause a fire.

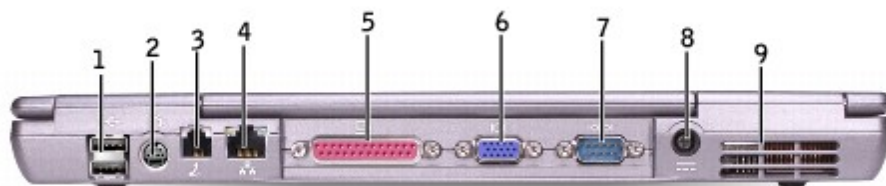

1	<a href="#">USB connectors (2)</a>	6	<a href="#">video connector</a>
2	<a href="#">S-video TV-out connector</a>	7	<a href="#">serial connector</a>
3	<a href="#">modem connector (RJ-11) (optional)</a>	8	<a href="#">AC adapter connector</a>
4	<a href="#">network connector (RJ-45)</a>	9	<a href="#">air vents</a>
5	<a href="#">parallel connector</a>		

**USB connectors**

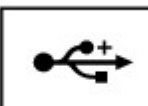
	<p>Connect USB devices, such as a mouse, keyboard, or printer. You can also connect the optional floppy drive directly to a USB connector using the optional floppy-drive cable.</p>
--	--



**S-video TV-out connector**

	<p>Connects your computer to a TV. For more information, see "<a href="#">Connecting a Television to the Computer.</a>"</p>
---	---

**modem connector (RJ-11) (optional)**

	<p>If you ordered the optional internal modem, connect the telephone line to the modem connector.</p> <p>For information on using the modem, see the online modem documentation supplied with your computer. See "<a href="#">Finding Information for Your Computer</a>."</p>
---	---

**network connector (RJ-45)**

-  **NOTICE:** The network connector is slightly larger than the modem connector. To avoid damaging the computer, do not plug a telephone line in to the network connector.

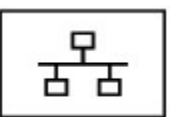
	<p>Connects the computer to a network. The green and yellow lights next to the connector indicate activity for both wired and wireless network communications.</p> <p>For information on using the network adapter, see the device user's guide supplied with your computer. See "<a href="#">Finding Information for Your Computer</a>."</p>
---	---

**parallel connector**

	<p>Connects a parallel device, such as a printer.</p>
--	---

**video connector**

	<p>Connects an external monitor. For more information, see "<a href="#">Using the Display</a>."</p>
---	---

**serial connector**

	<p>Connects serial devices, such as a mouse or handheld device.</p>
---	---

**AC adapter connector** — Attach an AC adapter to the computer.



The AC adapter converts AC power to the DC power required by the computer. You can connect the AC adapter with your computer turned either on or off.

**⚠ CAUTION:** The AC adapter works with electrical outlets worldwide. However, power connectors and power strips vary among countries. Using an incompatible cable or improperly connecting the cable to the power strip or electrical outlet may cause fire or equipment damage.

**➡ NOTICE:** When you disconnect the AC adapter cable from the computer, grasp the connector, not the cable itself, and pull firmly but gently to avoid damaging the cable.

**air vents** — The computer uses an internal fan to create airflow through the vents, which prevents the computer from overheating.

**✍ NOTE:** The computer turns on the fan when the computer gets hot. Fan noise is normal and does not indicate a problem with the fan or the computer.

**⚠ CAUTION:** Do not block, push objects into, or allow dust to accumulate in the air vents. Do not store your computer in a low-airflow environment, such as a closed briefcase, while it is running. Restricting the airflow can damage the computer or cause a fire.

---

## Bottom View

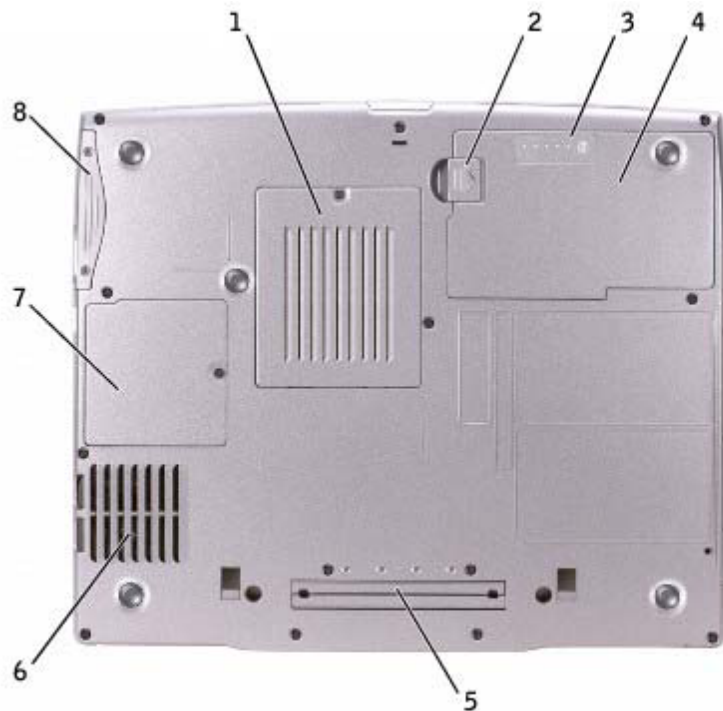

1	<a href="#">memory module cover</a>	5	<a href="#">docking device slot</a>
2	<a href="#">battery-bay latch release</a>	6	<a href="#">fan</a>
3	<a href="#">battery charge gauge</a>	7	<a href="#">Mini PCI card cover</a>
4	<a href="#">battery</a>	8	<a href="#">hard drive</a>

**memory module cover** — Covers the compartment that contains the memory module(s). See "[Adding and Replacing Parts](#)."

**battery-bay latch release** — Releases the battery. See "[Using a Battery](#)" for instructions.

**battery charge gauge** — Provides information on the battery charge. See "[Using a Battery](#)."

**battery** — When a battery is installed, you can use the computer without connecting the computer to an electrical outlet. See "[Using a Battery](#)."

**docking device slot** — Lets you attach your computer to a docking device. See the documentation that came with your docking device for additional information.

**fan** — The computer uses an internal fan to create airflow through the vents, which prevents the computer from overheating.

 **NOTE:** The computer turns on the fan when the computer gets hot. Fan noise is normal and does not indicate a problem with the fans or the computer.



 **CAUTION:** Do not block, push objects into, or allow dust to accumulate in the air vents. Do not store your computer in a low-airflow environment, such as a closed briefcase, while it is running. Restricting the airflow can damage the computer or cause a fire.

**Mini PCI card cover** — Covers the compartment that contains the Mini PCI card. See "[Adding and Replacing Parts](#)."

**hard drive** — Stores software and data.

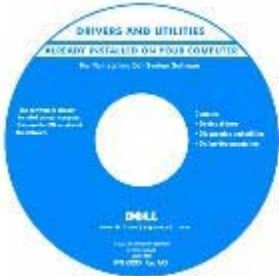
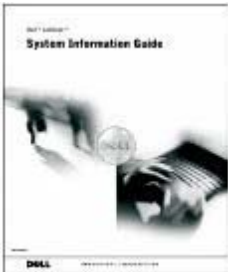

# Finding Information for Your Computer

What are you looking for?	Find It Here
<ul style="list-style-type: none"> <li>• A diagnostic program for my computer</li> <li>• Drivers for my computer</li> <li>• My computer documentation</li> <li>• My device documentation</li> </ul>	<p><b>Drivers and Utilities CD (also known as the ResourceCD)</b></p> <p>Documentation and drivers are already installed on your computer. You can use the CD to reinstall drivers, run the Dell Diagnostics, or access your documentation.</p> <p>Readme files may be included on your CD to provide last-minute updates about technical changes to your computer or advanced technical-reference material for technicians or experienced users.</p> 
<ul style="list-style-type: none"> <li>• How to set up my computer</li> <li>• Warranty information</li> <li>• Safety instructions</li> </ul>	<p><b>Dell™ System Information Guide</b></p>  <p><b>NOTE:</b> This document is available as a PDF at <a href="http://support.dell.com">support.dell.com</a>.</p>
<ul style="list-style-type: none"> <li>• How to remove and replace parts</li> <li>• Technical specifications</li> <li>• How to configure system settings</li> <li>• How to troubleshoot and solve problems</li> </ul>	<p><b>User's Guide</b></p> <p><i>Windows XP Help and Support Center</i></p> <ol style="list-style-type: none"> <li>1. Click the <b>Start</b> button and click <b>Help and Support</b>.</li> <li>2. Click <b>User's and system guides</b> and click <b>User's guides</b>.</li> </ol> <p><i>Microsoft Windows 2000</i></p>  <p>Double-click the <b>User's Guides</b> icon on your desktop.</p>
<ul style="list-style-type: none"> <li>• Service Tag and Express Service</li> </ul>	<p><b>Service Tag and Microsoft Windows License</b></p>

<ul style="list-style-type: none"> <li>Code</li> <li>• Microsoft Windows License Label</li> </ul>	<p>These labels are located on your computer.</p>  <ul style="list-style-type: none"> <li>• Use the Service Tag to identify your computer when you use <b>support.dell.com</b> or contact technical support.</li> <li>• Enter the Express Service Code to direct your call when contacting technical support. The Express Service Code is not available in all countries.</li> <li>• Use the number on the Microsoft Windows License Label if you reinstall your operating system.</li> </ul>
<ul style="list-style-type: none"> <li>• Latest drivers for my computer</li> <li>• Answers to technical service and support questions</li> <li>• Online discussions with other users and technical support</li> <li>• Documentation for my computer</li> </ul>	<p><b>Dell Support Website — support.dell.com</b></p> <p>The Dell Support website provides several online tools, including:</p> <ul style="list-style-type: none"> <li>• Solutions — Troubleshooting hints and tips, articles from technicians, and online courses</li> <li>• Community — Online discussion with other Dell customers</li> <li>• Upgrades — Upgrade information for components, such as memory, the hard drive, and the operating system</li> <li>• Customer Care — Contact information, order status, warranty, and repair information</li> <li>• Downloads — Drivers, patches, and software updates</li> <li>• Reference — Computer documentation, product specifications, and white papers</li> </ul>
<ul style="list-style-type: none"> <li>• Service call status and support history</li> <li>• Top technical issues for my computer</li> <li>• Frequently asked questions</li> <li>• File downloads</li> <li>• Details on my computer configuration</li> <li>• Service contract for my computer</li> </ul>	<p><b>Dell Premier Support Website — premiersupport.dell.com</b></p> <p>The Dell Premier Support website is customized for corporate, government, and education customers. This website may not be available in all regions.</p>
<ul style="list-style-type: none"> <li>• How to use Windows XP</li> <li>• Documentation for my computer</li> <li>• Documentation for devices (such as a modem)</li> </ul>	<p><b>Windows Help and Support Center</b></p> <ol style="list-style-type: none"> <li>1. Click the <b>Start</b> button and click <b>Help and Support</b>.</li> <li>2. Type a word or phrase that describes your problem and click the arrow icon.</li> <li>3. Click the topic that describes your problem.</li> <li>4. Follow the instructions on the screen.</li> </ol>
<ul style="list-style-type: none"> <li>• How to reinstall my operating system</li> </ul>	<p><b>Operating System CD</b></p> <p>The operating system is already installed on your computer. To resinstall your operating system, use the Operating System CD. See your <i>User's Guide</i> for operating system reinstallation instructions.</p> <p>After you reinstall your operating system, use the <a href="#">Drivers and Utilities CD</a> to</p>

reinstall drivers for the devices that came with your computer.



Your operating system [product key](#) label is located on your computer.