

Dell™ 968 All-In-One Printer User's Guide

To order ink or supplies from Dell:

1. Double-click the icon on your desktop.



2. Visit Dell's website, or order Dell printer supplies by phone.

www.dell.com/supplies

For the best service, make sure you have the Dell printer Service Tag available.

[Finding Information](#)

[About Your Printer](#)

[Understanding the Operator Panel Menus](#)

[Loading Paper and Originals](#)

[Printing](#)

[Printing From a Memory Card or USB Key](#)

[Copying](#)

[Scanning](#)

[Faxing](#)

[Understanding the Software](#)

[Networking](#)

[Maintenance](#)

[Troubleshooting](#)

[Specifications](#)

[Appendix](#)

[Licensing Notice](#)

Notes, Notices, and Cautions

 **NOTE:** A **NOTE** indicates important information that helps you make better use of your printer.

 **NOTICE:** A **NOTICE** indicates either potential damage to hardware or loss of data and tells you how to avoid the problem.

 **CAUTION:** A **CAUTION** indicates a potential for property damage, personal injury, or death.

Information in this document is subject to change without notice.

© 2007 Dell Inc. All rights reserved.

Reproduction in any manner whatsoever without the written permission of Dell Inc. is strictly forbidden.

Trademarks used in this text: *Dell*, the *DELL* logo, and *Dell Ink Management System* are trademarks of Dell Inc.; *Microsoft* and *Windows* are registered trademarks of Microsoft Corporation in the United States and/or other countries. *Windows Server* and *Windows NT* are registered trademarks of Microsoft Corporation. *Windows Vista* is either a trademark or a registered trademark of Microsoft Corporation in the United States and/or other countries. *Bluetooth* is a registered trademark owned by Bluetooth SIG, Inc. and is used by Dell Inc. under license. *EMC* is a registered trademark of EMC Corporation. *Corel Snapfire* and *WordPerfect* are trademarks or registered trademarks of Corel Corporation and/or its subsidiaries in Canada, the United States and/or other countries.

Other trademarks and trade names may be used in this document to refer to either the entities claiming the marks and names or their products. Dell Inc. disclaims any proprietary interest in trademarks and trade names other than its own.



UNITED STATES GOVERNMENT RESTRICTED RIGHTS

This software and documentation are provided with RESTRICTED RIGHTS. Use, duplication or disclosure by the Government is subject to restrictions as set forth in subparagraph (c)(1)(ii) of the Rights in Technical Data and Computer Software clause at DFARS 252.227-7013 and in applicable FAR provisions: Dell Inc., One Dell Way, Round Rock, Texas, 78682, USA.

Model 968

October 2007 SRV FY276 Rev. A00

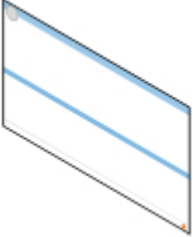
Finding Information

What are you looking for?	Find it here
<ul style="list-style-type: none">• Drivers for my printer• My User's Guide• Optional XPS driver	<p>Drivers and Utilities CD</p>  <p>If you purchased your Dell computer and printer at the same time, documentation and drivers for your printer are already installed on your computer. You can use the CD to uninstall/reinstall drivers or access your documentation. Readme files may be included on your CD to provide last-minute updates about technical changes to your printer or advanced technical reference material for experienced users or technicians.</p> <p>The XML Paper Specification (XPS) driver is an optional additional driver that allows Windows Vista™ users to access the improved graphics and color features of XPS. The driver is located in a zipped file on the CD. For more information, see Installing the Optional XPS Driver.</p>
How to set up my printer	Setting Up Your Printer poster 
<ul style="list-style-type: none">• Safety information• How to set up and use my printer• Warranty information	Owner's Manual 
Express Service Code and Service Tag number	Express Service Code and Service Tag number



For more information, see [Express Service Code](#).

<ul style="list-style-type: none"> • Latest drivers for my printer • Answers to technical service and support questions • Documentation for my printer 	<p>Dell Support Website: support.dell.com</p> <p>The Dell Support website provides several online tools, including:</p> <ul style="list-style-type: none"> • Solutions—Troubleshooting hints and tips, articles from technicians, and online courses • Upgrades—Upgrade information for components, such as memory • Customer Care—Contact information, order status, warranty, and repair information • Downloads—Drivers • Reference—Printer documentation and product specifications
<ul style="list-style-type: none"> • How to use Windows Vista • Documentation for my printer 	<p>Windows Vista Help and Support Center</p> <ol style="list-style-type: none"> 1. Click  Help and Support. 2. Type a word or phrase that best describes your problem, and then click the arrow icon. 3. Click the topic that describes your problem. 4. Follow the instructions shown on the screen.
<ul style="list-style-type: none"> • How to use Microsoft® Windows® XP • Documentation for my printer 	<p>Windows XP Help and Support Center</p> <ol style="list-style-type: none"> 1. Click Start® Help and Support. 2. Type a word or phrase that best describes your problem, and then click the arrow icon. 3. Click the topic that describes your problem. 4. Follow the instructions shown on the screen.

Faxing

- [Setting Up the Printer With External Devices](#)
- [Sending a Fax](#)
- [Receiving a Fax](#)
- [Changing the Fax Setup](#)
- [Using Speed Dial](#)
- [Blocking Faxes](#)
- [Creating Fax Activity Report](#)

You can use your printer to send and receive faxes without having to connect to a computer.

In addition, the Dell™ Fax Solutions Software is bundled in the *Drivers and Utilities* CD and should have been installed when you installed your printer software. You can also use this faxing software to send and receive faxes. For more information, see [Using the Dell Fax Solutions Software](#).

Equipment	Benefits	See this section
<ul style="list-style-type: none">• printer• phone cord (provided)	Make copies and send and receive faxes without the use of a computer.	Connecting Directly to a Telephone Wall Jack
<ul style="list-style-type: none">• printer• telephone (sold separately)• two phone cords (one provided)	<ul style="list-style-type: none">• Use the fax line as a normal telephone line.• Set up your printer wherever your telephone is.• Make copies and send and receive faxes without the use of a computer.	Connecting to a Telephone
<ul style="list-style-type: none">• printer• telephone (sold separately)• answering machine (sold separately)• three phone cords (one provided)	Receive both incoming voice messages and faxes.	Connecting to an Answering Machine
<ul style="list-style-type: none">• printer• telephone (sold separately)• computer modem (sold separately)• three phone cords	Increase the number of phone connection outlets.	Connecting to a Computer Modem

(one provided)

- USB cable (sold separately)

Setting Up the Printer With External Devices

Connecting Directly to a Telephone Wall Jack

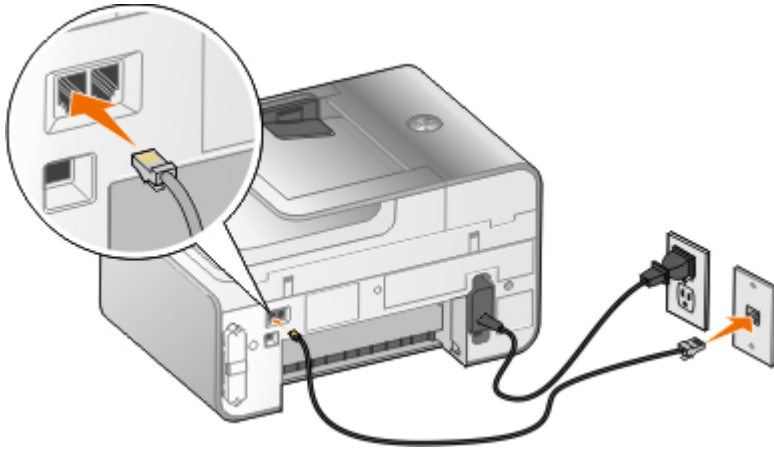

1. Connect one end of the phone cord to the FAX connector (FAX—left connector).
2. Connect the other end of the phone cord to an active telephone wall jack.

Connecting to a Telephone

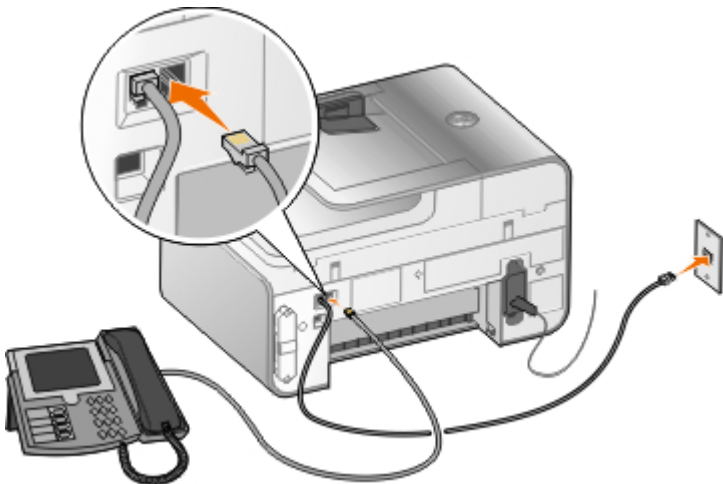

1. Connect a phone cord from the FAX connector (FAX—left connector) on the printer to an active telephone wall jack.
2. Remove the blue protective plug from the PHONE jack connector (PHONE—right connector).
3. Connect a phone cord from the telephone to the PHONE jack connector (PHONE—right connector).

NOTE: If phone communication is serial in your country (such as Germany, Sweden, Denmark, Austria, Belgium, Italy, France, and Switzerland), remove the blue plug from the PHONE jack

connector (—right connector), and insert the supplied yellow terminator for your fax to work correctly. You will not be able to use this port for additional devices in these countries.

What if I have a Digital Subscriber Line (DSL)?

DSL delivers digital data to a computer through a telephone line. Your printer is designed to work with analog data. If you are faxing over a telephone line connected to a DSL modem, install a DSL filter to avoid interference with the analog fax modem signal.

NOTE: Integrated Services Digital Network (ISDN) and cable modems are not fax modems and are not supported for faxing.

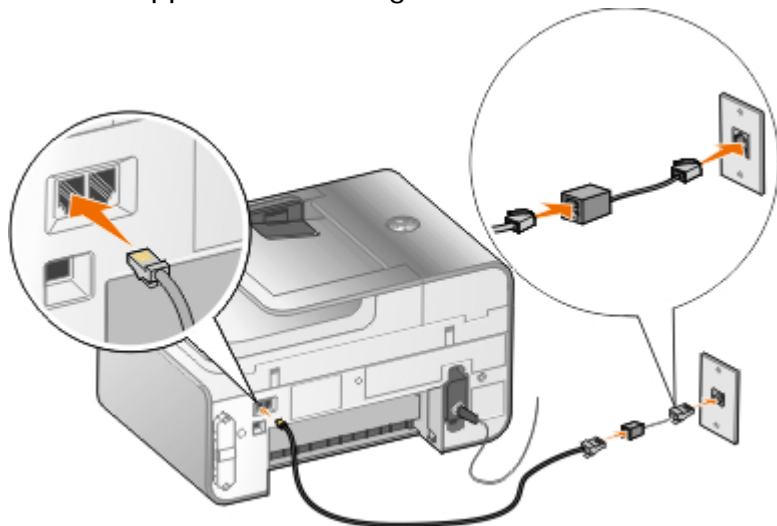

1. Connect the DSL filter to an active telephone line.
2. Connect the printer directly to the output on the DSL filter.

NOTE: Do not install any splitters between the DSL filter and the printer. Contact your DSL service provider if you need more help.

Connecting to an Answering Machine

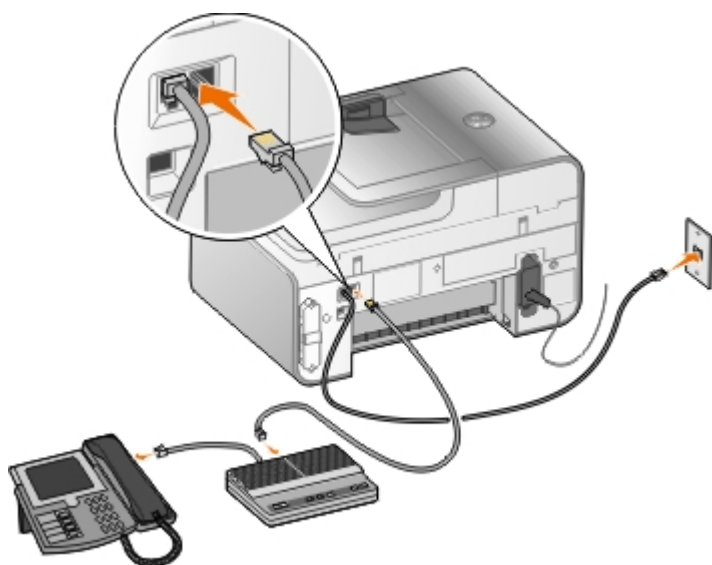

1. Connect a phone cord from the FAX connector (—left connector) on the printer to an active telephone wall jack.
2. Remove the blue protective plug from the PHONE jack connector (—right connector).

3. Connect a phone cord from the answering machine to a telephone.
4. Connect a phone cord from the answering machine to the PHONE jack connector (PHONE—right connector).

NOTE: If phone communication is serial in your country (such as Germany, Sweden, Denmark, Austria, Belgium, Italy, France, and Switzerland), you must remove the blue plug from the PHONE jack connector (PHONE—right connector), and insert the supplied yellow terminator for your fax to work correctly. You will not be able to use this port for additional devices in these countries.

Connecting to a Computer Modem

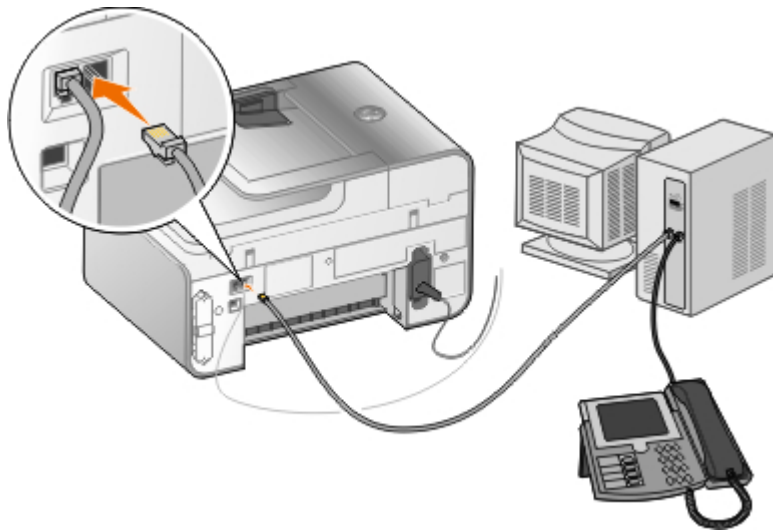

1. Connect a phone cord from the FAX connector (FAX—left connector) on the printer to an active telephone wall jack.
2. Remove the blue protective plug from the PHONE jack connector (PHONE—right connector).
3. Connect a phone cord from the computer modem to the PHONE jack connector (PHONE—right connector).
4. Connect a phone cord from the computer modem to a telephone.

NOTE: If phone communication is serial in your country (such as Germany, Sweden, Denmark, Austria, Belgium, Italy, France, and Switzerland), you must remove the blue plug from the PHONE jack connector (PHONE—right connector), and insert the supplied yellow terminator for your fax to work correctly. You will not be able to use this port for additional devices in these countries.



Sending a Fax

Sending a Quick Fax

Using the Operator Panel

1. Make sure your printer is properly set up to send and receive faxes. For more information, see

[Setting Up the Printer With External Devices.](#)

2. Load the original document. For more information, see [Loading Original Documents](#).
3. Press the up or down **Arrow** button   to scroll to Fax.
4. Use the keypad to enter a fax number or a speed dial number.
5. Press the **Start** button .

Using Your Computer

1. Turn on your computer and printer, and make sure they are connected.
2. Make sure your printer is properly set up to send and receive faxes. For more information, see [Setting Up the Printer With External Devices](#).
3. Load the original document. For more information, see [Loading Original Documents](#).
4. *In Windows Vista™:*
 - a. Click  **Programs**.
 - b. Click **Dell Printers**.
 - c. Click **Dell 968 AIO Printer**.

In Microsoft® Windows® XP or Windows 2000:



Click **Start® Programs** or **All Programs® Dell Printers® Dell 968 AIO Printer**.



5. Select **Dell Fax Solutions**.















The **Dell Fax Solutions Software** dialog box opens.
6. Click **Send a new fax**.
7. Follow the instructions on your computer screen to send a fax.

Entering a Fax Number

Using the Operator Panel

1. From the main menu, press the up or down **Arrow** button   to scroll to Fax.
2. Enter a fax number.

Task	Method
Sending to a fax number	Use the keypad to enter a number. You can enter a maximum of 64 digits in a fax number.
Sending a fax to an entry in the Phone Book	<ul style="list-style-type: none">• Enter the number that corresponds to the speed dial number of the contact.• Use the Phone Book menu.<ol style="list-style-type: none">a. Press the up or down Arrow button   to scroll to Fax,

	<p>and then press the Select button .</p> <p>b. From Phone Book, press the Select button .</p> <p>c. Press the up or down Arrow button  to scroll to Name Search, Phone Number Search, or Group Search, and then press the Select button .</p> <p>d. Press the up or down Arrow button  to scroll to the name or number you want to send the fax to.</p>
Sending a fax to an extension number	Press the asterisk (*) and pound (#) signs, and then use the keypad to enter the extension number.
Sending a fax to an outside line	<p>Set a dial prefix:</p> <p>a. From the main menu, press the up or down Arrow button  to scroll to Fax, and then press the Select button .</p> <p>b. Press the down Arrow button  to scroll to Fax Setup, and then press the Select button .</p> <p>c. Press the down Arrow button  to scroll to Dialing and Sending, and then press the Select button .</p> <p>d. Press the up or down Arrow button  to scroll to Dial Prefix, and then press the left or right Arrow button  to scroll to Create.</p> <p>e. Press the Select button .</p> <p>NOTE: If you are changing the dial prefix, scroll to Modify.</p> <p>f. Use the keypad to enter the dial prefix. You can enter a maximum of eight digits for the prefix.</p> <p>g. Press the Select button .</p>
Dialing a fax extension while listening to a telephone line (On Hook)	Dial an additional 0 for a two-digit extension or an additional 0 0 for a one-digit extension. For example, to dial extension 12, enter 120. If the extension is 2, enter 200.

Using Your Computer

1. Turn on your computer and printer, and make sure they are connected.
2. Make sure your printer is properly set up to send and receive faxes. For more information, see [Setting Up the Printer With External Devices](#).
3. Load the original document. For more information, see [Loading Original Documents](#).
4. *In Windows Vista:*
 - a. Click  **Programs**.
 - b. Click **Dell Printers**.

c. Click **Dell 968 AIO Printer**.

In Windows XP or Windows 2000:

Click **Start® Programs** or **All Programs® Dell Printers® Dell 968 AIO Printer**.

5. Select **Dell Fax Solutions**.

The **Dell Fax Solutions Software** dialog box opens.

6. Click **Send a new fax**.

The **Send fax** dialog box opens.

7. Enter the contact information for the recipient into the Name, Company, and Fax Number fields, or click **Select a recipient from phonebook** to add existing contacts to the recipient list.

8. If you want to add the new contact to the phonebook, click **Add this recipient to phonebook**.

9. If you want to send the fax to more than one recipient, click **Add another recipient**.

a. Enter the contact information for the next recipient into the Name, Company, and Fax Number fields, or click **Select a recipient from phonebook** to add existing contacts to the recipient list.

b. If you want to add the new contact to the phonebook, click **Add this recipient to phonebook**.

c. If you manually enter the contact information, click **Add** to add the contact to the Recipients list.

d. To make changes to the Recipients information, select the recipient, and then click **Edit**.

e. To remove the contact from the Recipients list, select the recipient, and then click **Remove**.

f. Repeat [step a](#) through [step e](#) until your Recipients list is complete.

10. Click **Next**.

11. Follow the instructions on your computer screen to send a fax.

Sending Advanced Faxes

Using the Operator Panel

If you are using your printer as a standalone fax machine, you can use the various Fax submenus to customize your outgoing faxes. From the Fax Menu, you can:

- Send a delayed fax
- Send faxes using your Speed Dial list
- Manage your phonebook to send faxes to individuals or groups
- Personalize your fax cover page
- Create and print a fax history

- Create and print a fax report

For more information, see [Fax Mode](#).

Using Your Computer

Use the Dell Fax Solutions Software to take advantage of advanced fax features. In addition to basic faxing, the Dell Fax Solutions Software also allows you to:

- Send a delayed fax
- Send electronic files and paper documents in a single fax operation
- Send faxes using your Speed Dial list
- Manage your phonebook to easily send faxes to individuals or groups
- Personalize and store various cover pages
- Create and print a fax history
- Create and print a fax report

For more information, see [Using the Dell Fax Solutions Software](#).

1. *In Windows Vista:*

- a. Click  **Programs**.
- b. Click **Dell Printers**.
- c. Click **Dell 968 AIO Printer**.

In Windows XP and Windows 2000:

Click **Start**® **Programs** or **All Programs**® **Dell Printers**® **Dell 968 AIO Printer**.

2. Click **Dell Fax Solutions**.

The **Dell Fax Solutions Software** dialog box opens.

3. Click the appropriate links on the **Dell Fax Solutions Software** dialog box to accomplish your task.
4. Follow the instructions on the computer screen.





Sending a Fax Through an Automated Answering System

Some companies have automated answering systems that require you to respond to a series of questions to route you to the department you wish to call. After answering the questions by pressing the appropriate buttons, you eventually get connected to the proper department. To send a fax to a company that employs an automated answering system, set up your printer for On Hook dialing.

1. Make sure your printer is properly set up to send and receive faxes. For more information, see [Setting Up the Printer With External Devices](#).
2. Load the original document facing down on the scanner glass. For more information, see [Loading Original Documents](#).
3. From the operator panel, press the up or down **Arrow** button to scroll to Fax, and then press















the **Select** button .



4. Press the up or down **Arrow** button  to scroll to On Hook Dial, and then press the **Select** button .
 5. Modify your cover page information if necessary, and then press the **Back** button .
 6. Using the keypad, dial the telephone number of the company.
 7. Using the keypad, navigate through the automated answering system.
 8. When you hear the fax tone, press the **Start** button  to begin sending your fax.
- To cancel the fax job, press the **Cancel** button  on your printer.

Receiving a Fax









Receiving a Fax Automatically

1. Make sure your printer is on and connected to an active telephone line.
2. Make sure **Auto Answer** is turned on or is currently within the scheduled on period.
 - a. From the main menu, press the up or down **Arrow** button  to scroll to Fax, and then press the **Select** button .
 - b. Press the up or down **Arrow** button  to scroll to Auto Answer.
 - c. Press the left or right **Arrow** button  to scroll to On or Scheduled, and then press the **Select** button .
 - d. If you selected Scheduled, the **Auto Answer Schedule** screen appears. Use the keypad to specify the time you want **Auto Answer** to be turned on and turned off.
 - e. Press the **Back** button .
3. Set the number of rings the printer should allow before answering the incoming fax.
 - a. From the main menu, press the up or down **Arrow** button  to scroll to Fax, and then press the **Select** button .
 - b. Press the down **Arrow** button  to scroll to Fax Setup, and then press the **Select** button .
 - c. Press the up or down **Arrow** button  to scroll to Ringing and Answering, and then press the **Select** button .
 - d. Press the up or down **Arrow** button  to scroll to Pick-up On.
 - e. Press the left or right **Arrow** button  to select the number of rings you want to allow before the printer receives the fax.
 - f. Press the **Back** button .

When the number of set rings is detected, the printer automatically receives the fax.











Receiving a Fax Manually

You can turn the Auto Answer feature off if you wish to control the faxes that you receive. This is useful if you do not want to receive unsolicited faxes, if you rarely receive faxes, or if it is expensive to use faxes in your area.

1. Make sure your printer is on and properly set up to receive faxes. For more information, see [Setting Up the Printer With External Devices](#).
2. Turn **Auto Answer** off.
 - a. From the main menu, press the up or down **Arrow** button   to scroll to Fax, and then press the **Select** button .
 - b. Press the up or down **Arrow** button   to scroll to Auto Answer.
 - c. Press the left or right **Arrow** button   to scroll to Off.
 - d. Press the **Back** button .
3. When the telephone rings, pick up the telephone attached to the printer and listen for the fax calling tone.
4. If you hear the fax calling tone, type **DELL# (3355#)** on the operator panel keypad or on the telephone keypad.

 **NOTE:** **DELL#** is the default answer code. However, you can change this to any code. For more information, see [Changing the Pickup Code](#).

Changing the Pickup Code









1. From the main menu, press the up or down **Arrow** button   to scroll to Fax, and then press the **Select** button .
2. Press the down **Arrow** button  to scroll to Fax Setup, and then press the **Select** button .
3. Press the up or down **Arrow** button   to scroll to Ringing and Answering, and then press the **Select** button .
4. Press the up or down **Arrow** button   to scroll to Manual Pickup Keycode, and then press the **Select** button .
5. Use the keypad to specify a new one- to seven-digit keycode.

 **NOTE:** Valid characters for the pickup code are 0–9, pound (#), and star (*). Any other characters entered are ignored.

6. Press the **Select** button .

Printing a Long Fax

Using the Operator Panel

1. From the main menu, press the up or down **Arrow** button to scroll to Fax, and then press the **Select** button .
2. Press the down **Arrow** button  to scroll to Fax Setup, and then press the **Select** button .
3. Press the up or down **Arrow** button  to scroll to Fax Printing, and then press the **Select** button .
4. From If Too Big, press the left or right **Arrow** button  to choose an option.
5. Press the **Back** button .

Using Your Computer

1. Turn on your computer and printer, and make sure they are connected.
2. Make sure your printer is properly set up to send and receive faxes. For more information, see [Setting Up the Printer With External Devices](#).
3. *In Windows Vista:*
 - a. Click  **Programs**.
 - b. Click **Dell Printers**.
 - c. Click **Dell 968 AIO Printer**.

In Windows XP or Windows 2000:

Click **Start**[®] **Programs** or **All Programs**[®] **Dell Printers**[®] **Dell 968 AIO Printer**.

4. Select **Dell Fax Setup Utility**.











The **Dell Fax Setup Wizard Query** dialog box opens.
5. Click **No**.

The **Dell Fax Setup Utility** dialog box opens.
6. Click the **Fax Printing/Reports** tab.
7. From the **If fax is too big** field, choose an option.
8. Click **OK**.

A confirmation dialog box opens.
9. Click **OK** to overwrite the fax settings on your printer.
10. Click **Close**.

Printing a Fax on Both Sides of the Page

Using the Operator Panel

1. From the main menu, press the up or down **Arrow** button   to scroll to Fax, and then press the **Select** button .
2. Press the down **Arrow** button  to scroll to Fax Setup, and then press the **Select** button .
3. Press the up or down **Arrow** button   to scroll to Fax Printing, and then press the **Select** button .
4. From the **2-Sided Print** menu item, press the left or right **Arrow** button   to scroll to 2 Sided Print.
5. Press the **Back** button .

Using the Computer

1. Turn on your computer and printer, and make sure they are connected.
2. Make sure your printer is properly set up to send and receive faxes. For more information, see [Setting Up the Printer With External Devices](#).
3. *In Windows Vista:*
 - a. Click  **Programs**.
 - b. Click **Dell Printers**.
 - c. Click **Dell 968 AIO Printer**.

In Windows XP or Windows 2000:

Click **Start**® **Programs** or **All Programs**® **Dell Printers**® **Dell 968 AIO Printer**.

4. Select **Dell Fax Setup Utility**.
The **Dell Fax Setup Wizard Query** dialog box opens.
5. Click **No**.
The **Dell Fax Setup Utility** dialog box opens.
6. Click the **Fax Printing/Reports** tab.
7. From the **2-sided print** field, choose **Print duplex**.
8. Click **OK**.
A confirmation dialog box opens.
9. Click **OK** to overwrite the fax settings on your printer.
10. Click **Close**.

Changing the Fax Setup

Using the Operator Panel

If you are using your printer as a standalone fax machine, you can change the fax settings from the **Fax Setup** menu. Changes made on the **Fax Setup** menu are permanent and are applicable to all fax jobs. For more information, see [Fax Setup Menu](#).

Using the Computer

You can access the **Fax Setup Utility** if you want to configure the printer's fax settings from your computer.

1. For *Windows Vista*:

- a. Click  **Programs**.
- b. Click **Dell Printers**.
- c. Click **Dell 968 AIO Printer**.

For Windows XP and Windows 2000:

Click **Start**® **Programs** or **All Programs**® **Dell Printers**® **Dell 968 AIO Printer**.

2. Select **Dell Fax Setup Utility**.

The **Dell Fax Setup Utility Wizard Query** dialog box opens.

3. If you want to use the Fax Setup Utility Wizard to set up your printer for faxing, click **Yes**. The **Fax Setup Utility Wizard Welcome** dialog box opens.

If you want to manually adjust your fax settings, click **No**. The **Dell Fax Setup Utility** dialog box opens.

On this tab:	You can:
Dialing and Sending	<ul style="list-style-type: none"> • Specify a dial method. • Enter a dial prefix. • Set the dial volume. • Enter your fax number and your name. • Specify the number of times you want the machine to redial and the time between those attempts if the fax cannot be sent on the first try. • Choose whether to scan the entire document before or after dialing the number. • Specify a maximum send speed and a print quality for outgoing faxes. • Convert the fax automatically to be compatible with the receiving fax machine regardless of the send settings.
Ringing and Answering	<ul style="list-style-type: none"> • Specify the number of rings before the machine receives the incoming fax. <p>NOTE: The number of rings set on the answering machine must always be less than the number of rings set on the printer.</p> <ul style="list-style-type: none"> • Specify a distinctive ring if your phone line has distinctive ring service activated. • Set the ring volume.

	<ul style="list-style-type: none"> • Choose whether to use error correction. • Choose a Caller ID pattern (1 if telephones in your country have a detection pattern using FSK or 2 if telephones in your country have a detection pattern using DTMF). The Caller ID detection pattern is determined by the country or region you selected during initial setup. If phones in your country use two detection patterns, call your telecommunications company to know which pattern it subscribes to. • Specify a manual answer code. The default code is DELL# (3355#). • Choose whether you want to answer incoming faxes automatically or at a scheduled time. • Specify the time when incoming faxes are answered automatically. • Select whether you want to forward a fax, or print it and then forward it. • Specify a fax number to which faxes are forwarded. • Manage blocked faxes.
Fax Printing/Reports	<ul style="list-style-type: none"> • Choose to automatically resize oversize faxes so they print on one page, or keep the oversized fax to scale and print on two pages. • Choose whether you want to print a footer (date, time, and page number) on each page. • If an optional second paper tray is installed, choose from which tray the printer picks paper. Choose Auto if you want the printer to pick the paper that matches the size of the incoming fax. • If an optional duplex is installed, choose if you want to print on both sides of the page. • Specify when to print a fax activity report. • Specify when you want to print a fax confirmation.
Speed Dial	Add to, create, or edit the speed dial or group dial speed dial lists.
Cover Page	<ul style="list-style-type: none"> • Specify if you want to send a cover page for outgoing faxes. • Edit or update the information that will appear on your cover page. • Choose a priority for your outgoing fax. • Include a short message.

Using Speed Dial











To make sending faxes easier, you can assign a speed dial number to 89 individual contacts and 10 groups that can hold up to 30 phone numbers each using the printer operator panel.

To create a Speed Dial or Group Dial list using your computer, see [Changing the Fax Setup](#).













Creating a Speed or Group Dial List

Using the Operator Panel

Adding an Entry to the Speed Dial List

1. From the main menu, press the up or down **Arrow** button   to scroll to Fax, and then press the **Select** button .
2. Press the up or down **Arrow** button   to scroll to Phone Book, and then press the **Select** button .
3. Press the up or down **Arrow** button   to scroll to Add Entry, and then press the **Select** button .
4. Use the keypad to enter a Name and Fax Number.
 **NOTE:** The lowest possible speed dial number is automatically assigned to this contact. You cannot change the speed dial number.
5. Press the **Back** button .

Adding an Entry to the Group Dial List

1. From the main menu, press the up or down **Arrow** button   to scroll to Fax, and then press the **Select** button .
2. Press the up or down **Arrow** button   to scroll to Phone Book, and then press the **Select** button .
3. Press the up or down **Arrow** button   to scroll to Add Group, and then press the **Select** button .
4. Use the keypad to assign a name and fax numbers to the group. Press the down **Arrow** button  to enter another number. You can also use the **Name Search**, **Phone Number Search**, or **Redial History** option to select phone numbers. Each number you select or enter is added to the group dial list.
 **NOTE:** The lowest possible group dial number is automatically assigned to this contact. You cannot change the speed dial number.
5. Press the **Back** button .

Using the Computer

1. Turn on your computer and printer, and make sure they are connected.
2. Make sure your printer is properly set up to send and receive faxes. For more information, see [Setting Up the Printer With External Devices](#).
3. *In Windows Vista:*
 - a. Click  **Programs**.

- b. Click **Dell Printers**.
- c. Click **Dell 968 AIO Printer**.

In Windows XP or Windows 2000:

Click **Start® Programs** or **All Programs® Dell Printers® Dell 968 AIO Printer**.

4. Select **Dell Fax Setup Utility**.

The **Dell Fax Setup Wizard Query** dialog box opens.

5. Click **No**.

The **Dell Fax Setup Utility** dialog box opens.

6. Click the **Speed Dial** tab.

7. To add a new entry to your Speed Dial list, click on an available number from 1 to 89, and enter the fax number and name of your new contact.

To add a new group entry to your Group Dial list, click on an available number from 90 to 99. A smaller group list appears below the main Speed Dial list. Enter the fax numbers and names of your new group entry.

8. To add contacts from your phonebook, click **Select from phonebook**.

The **Select from phonebook** dialog box opens.

- a. Select a contact from your phonebook.
- b. If you want to add the contact to your list, click on an available number on the Speed or Group Dial Settings section.

If you want to overwrite an existing entry on your list, click the entry you want to change.
- c. Click **Add to or change list**.
- d. After adding phonebook entries to your Speed or Group Dial list, click **OK** to return to the Speed Dial tab.





9. Click **OK**.

A confirmation dialog box appears.

10. Click **OK** to overwrite the settings on your printer.

11. Click **Close**.

Using a Speed or Group Dial List

1. From the main menu, press the up or down **Arrow** button   to scroll to Fax, and then press the **Select** button .
2. Use the keypad to enter the two-digit speed dial number.
3. Press the **Start** button .











 **NOTE:** When you are entering numbers, if you only enter two numbers and an entry corresponds to this number, the printer assumes you are entering a speed dial entry. If the number you entered

does not correspond to any entry in the Phone Book, the printer assumes you are entering an extension number.

Blocking Faxes

Creating a Blocked Fax List

Using the Operator Panel

1. From the main menu, press the up or down **Arrow** button   to scroll to Fax, and then press the **Select** button .
2. Press the down **Arrow** button  to scroll to Fax Setup, and then press the **Select** button .
3. Press the down **Arrow** button  to scroll to Fax Blocking, and then press the **Select** button .
4. Press the down **Arrow** button  to scroll to Blocked Fax Add Entry, and then press the **Select** button .
5. Use the keypad to specify a name.
6. Use the keypad to enter a fax number, and then press the **Select** button .

 **NOTE:** The lowest possible blocked fax number is automatically assigned to this contact. You cannot change the blocked fax number.

Using Your Computer

1. Turn on your computer and printer, and make sure they are connected.
2. Make sure your printer is properly set up to send and receive faxes. For more information, see [Setting Up the Printer With External Devices](#).
3. *In Windows Vista:*
 - a. Click  **Programs**.
 - b. Click **Dell Printers**.
 - c. Click **Dell 968 AIO Printer**.

In Windows XP or Windows 2000:











Click **Start**  **Programs** or **All Programs**  **Dell Printers**  **Dell 968 AIO Printer**.

4. Select **Dell Fax Setup Utility**.
The **Dell Fax Setup Wizard Query** dialog box opens.
5. Click **No**.
The **Dell Fax Setup Utility** dialog box opens.
6. Click the **Ringing and Answering** tab.

7. Click **Manage Blocked Faxes**.
The **Manage Blocked Faxes** dialog box opens.
8. Enter the fax numbers that you want to block on the list.
9. Click **OK** to return to the Ringing and Answering tab.
10. Click **OK**.
A confirmation dialog box opens.
11. Click **OK** to overwrite the fax settings on your printer.
12. Click **Close**.

Turning on Fax Blocking

Using the Operator Panel

1. From the main menu, press the up or down **Arrow** button   to scroll to Fax, and then press the **Select** button .
2. Press the down **Arrow** button  to scroll to Fax Setup, and then press the **Select** button .
3. Press the down **Arrow** button  to scroll to Fax Blocking, and then press the **Select** button .
4. From Block List, press the left or right **Arrow** button   to choose On.
5. Press the **Back** button .

If the printer detects a fax from one of the numbers on the Blocked Fax List, the transmission is disconnected.

Using Your Computer

1. Turn on your computer and printer, and make sure they are connected.
2. Make sure your printer is properly set up to send and receive faxes. For more information, see [Setting Up the Printer With External Devices](#).
3. *In Windows Vista:*
 - a. Click  **Programs**.
 - b. Click **Dell Printers**.
 - c. Click **Dell 968 AIO Printer**.

In Windows XP or Windows 2000:

Click **Start**® **Programs** or **All Programs**® **Dell Printers**® **Dell 968 AIO Printer**.

4. Select **Dell Fax Setup Utility**.

The **Dell Fax Setup Wizard Query** dialog box opens.

5. Click **No**.

The **Dell Fax Setup Utility** dialog box opens.

6. Click the **Ringing and Answering** tab.
7. Click **Manage Blocked Faxes**.

The **Manage Blocked Faxes** dialog box opens.











8. Select **Enable fax blocking**.
9. Click **OK** to return to the Ringing and Answering tab.
10. Click **OK**.

A confirmation dialog box opens.

11. Click **OK** to overwrite the fax settings on your printer.
12. Click **Close**.

Blocking Faxes Without Caller ID

Using the Operator Panel

1. From the main menu, press the up or down **Arrow** button   to scroll to Fax, and press the **Select**  button.
2. Press the down **Arrow** button  to scroll to Fax Setup, and press the **Select**  button.
3. Press the down **Arrow** button  to scroll to Fax Blocking, and press the **Select**  button.
4. From Block No-ID, press the left or right **Arrow** button   to choose On.
5. Press the **Select**  button.

If the printer detects a fax from a machine without Caller ID, the transmission is disconnected.

Using Your Computer

1. Turn on your computer and printer, and make sure they are connected.
2. Make sure your printer is properly set up to send and receive faxes. For more information, see [Setting Up the Printer With External Devices](#).
3. *In Windows Vista:*
 - a. Click  **Programs**.
 - b. Click **Dell Printers**.
 - c. Click **Dell 968 AIO Printer**.

In Windows XP or Windows 2000:

Click **Start**[®] **Programs** or **All Programs**[®] **Dell Printers**[®] **Dell 968 AIO Printer**.

4. Select **Dell Fax Setup Utility**.

The **Dell Fax Setup Wizard Query** dialog box opens.

5. Click **No**.

The **Dell Fax Setup Utility** dialog box opens.

6. Click the **Ringing and Answering** tab.
7. Click **Manage Blocked Faxes**.

The **Manage Blocked Faxes** dialog box opens.









8. Select **Always block faxes from senders missing a valid Caller ID**.
9. Click **OK** to return to the Ringing and Answering tab.
10. Click **OK**.

A confirmation dialog box opens.

11. Click **OK** to overwrite the fax settings on your printer.
 12. Click **Close**.
-

Creating Fax Activity Report

Using the Operator Panel

1. From the main menu, press the up or down **Arrow** button   to scroll to Fax, and then press the **Select** button .
2. Press the down **Arrow** button  to scroll to Fax Setup, and then press the **Select** button .
3. Press the up or down **Arrow** button   to scroll to History and Reports, and then press the **Select** button .
4. From the **History and Reports** menu, you can view or print your fax activity.

Using the Computer

1. *In Windows Vista:*
 - a. Click  **Programs**.
 - b. Click **Dell Printers**.
 - c. Click **Dell 968 AIO Printer**.

In Windows XP and Windows 2000:

Click **Start® Programs** or **All Programs® Dell Printers® Dell 968 AIO Printer**.

2. Click **Dell Fax Solutions**.

The **Dell Fax Solutions Software** dialog box opens.

3. Click **Print Activity Report**.
4. From the **Display** drop-down menu, select which faxes you would like to print a report.
5. Select a date range for your report.
6. Click the **Print** icon in the upper-left corner of the dialog box to print the fax report.

About Your Printer

- [Understanding the Printer Parts](#)
- [Understanding the Operator Panel](#)

You can use your printer to do a variety of things. A few important things to note:

- If the printer is connected to a computer, you can use either the printer operator panel or the printer software to produce quality documents.
- You *do* need to connect your printer to a computer to print, scan, or use the **Save Photos to Computer** function or the **Print Files** mode.
- You *do not* need to connect your printer to a computer to make photocopies, send faxes, or print from memory cards or a PictBridge-enabled camera.

 **NOTE:** The printer (whether it is connected to a computer or not) must be connected to a telephone line before you can send a fax.

 **NOTE:** If you use a DSL modem for your computer, you must install a DSL filter on the telephone line attached to your computer.

Understanding the Printer Parts

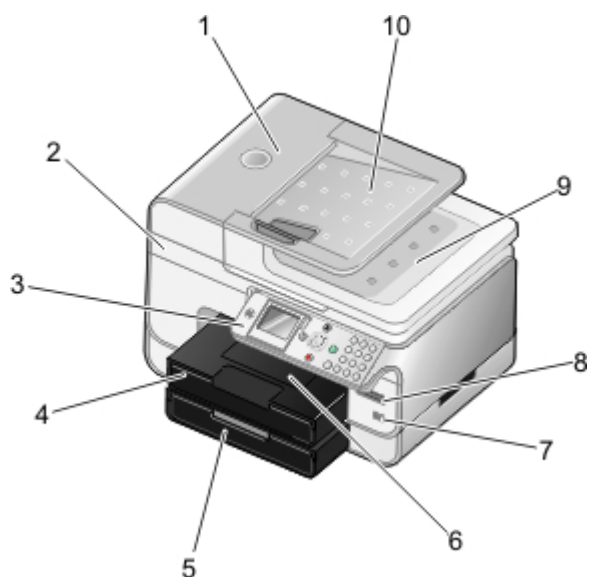

Number:	Part:	Description:
1	Automatic Document Feeder (ADF)	Part that feeds original documents into the printer.
2	Scanner base unit	Unit you lift to gain access to the ink cartridges.
3	Operator panel	Panel you use to control copying, scanning, faxing, and printing. For more information, see Understanding the Operator Panel .
4	Paper tray	Tray that holds blank paper.
5	Optional	Tray that you can purchase separately to increase the amount of blank paper

	paper tray	that your printer can hold.
6	Paper exit tray	Tray that holds the paper as it exits the printer. NOTE: Pull the paper exit tray stop straight out to extend it.
7	PictBridge connector	The connector you use to connect your PictBridge-enabled digital camera or a USB key to your printer.
8	Memory card slots	Slots into which you insert a memory card containing digital pictures. NOTE: The LCD only displays JPG and a limited set of TIFF files found on the memory card. To view other image types stored on the memory card, open the Memory Card Manager. For more information, see Using Memory Card Manager .
9	Top cover with integrated ADF exit tray	Top of printer that holds your document or photo flat while you scan it. You can also pick up your original document here after it has gone through the ADF.
10	ADF input tray	Tray that holds original documents. Use it to scan, copy, or fax multiple-page documents.

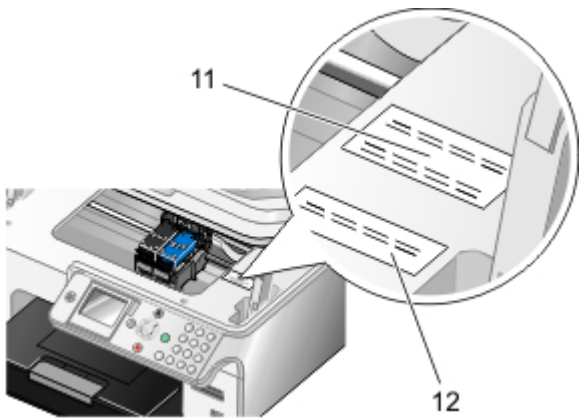

11	Express Service Code	<ul style="list-style-type: none"> Identify your printer when you use support.dell.com or contact technical support. Enter the Express Service Code to direct your call when contacting technical support. <p>NOTE: The Express Service Code is not available in all countries.</p>
12	Supplies Reorder Label	To order ink cartridges or paper, visit www.dell.com/supplies .

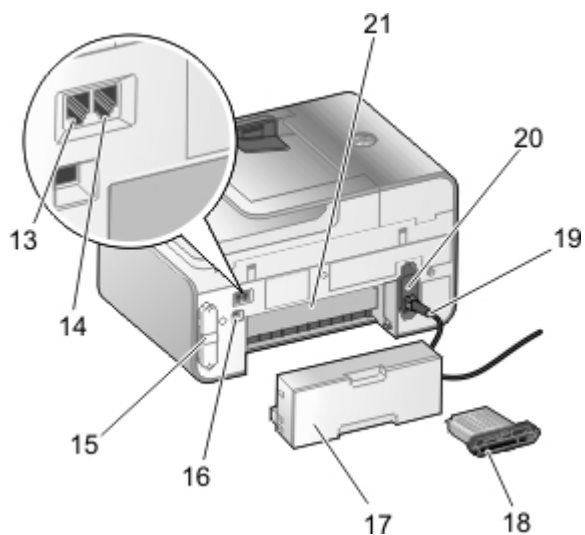



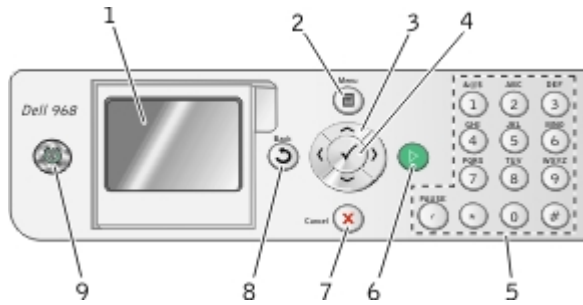

13	FAX connector (FAX— left connector)	Slot into which you plug an active telephone line to send and receive faxes. NOTE: Do not connect additional devices to the FAX connector (FAX— left connector), and do not connect a DSL (digital subscriber line) or ISDN (integrated services digital network) to the printer without using a digital line filter.
14	PHONE jack connector (— right connector)	Slot into which you plug additional devices, such as a data/fax modem, telephone, or answering machine. Remove the blue plug before use. NOTE: If the phone communication is serial in your country (such as Germany, Sweden, Denmark, Austria, Belgium, Italy, France, and Switzerland), you must remove the blue plug from the PHONE jack connector (— right connector), and then insert the supplied yellow terminator for faxing to work correctly. You will not be able to use this port for additional devices in these countries.
15	Back cover	Cover that you have to remove to install the Dell™ Internal Network Adapter 1150.
16	USB connector	Slot into which you plug the USB cable (sold separately). The other end of the USB cable plugs into your computer.
17	Optional duplex unit	Part that you can purchase separately to print on both sides of the paper.
18	Optional Dell Internal Network Adapter 1150	A networking device that you can purchase separately to set up your printer on a wireless or Ethernet network.
19	Power cord connector	Connects the printer power supply to the power outlet using the supplied country-specific power cord.
20	Power supply	Supplies power to the printer. NOTE: The power supply is removable. When the power supply is removed from the printer, but remains plugged into a power outlet, an LED is illuminated to notify you that power is present. NOTE: If the power is off when you unplug your printer, the power will be off when you plug it back in.
21	Rear access	Part that you have to open to clear paper jams.

door
(beneath
the
optional
duplex
unit)

Understanding the Operator Panel



Number	Use the:		To:
1	LCD display		Display scanning, copying, faxing, and printing options as well as status and error messages.
2	Menu button		Enter a menu or a submenu.
3	Arrow buttons		<ul style="list-style-type: none"> Navigate menus and menu items. Decrease/increase the number of copies. Change the selected modes. Navigate photos on a memory card or digital camera. Increase or decrease the values when setting the date and time.
4	Select button		<ul style="list-style-type: none"> Select a menu item. Select an image to be printed (in Photo mode). Initiate a paper feed by holding the button for three seconds.
5	Keypad		Enter numerical data or text.
6	Start button		Initiate a copy, scan, or fax.
7	Cancel button		<ul style="list-style-type: none"> Cancel a scan, print, or copy job in progress. Cancel a copy job (using only the printer), and eject the page. Exit a menu, and return to the default settings.
8	Back button		<ul style="list-style-type: none"> Return to the previous menu or screen. Save the changes made on a sub-menu temporarily.

9	Power button		<ul style="list-style-type: none">• When the printer is off, press the Power button  to turn your printer on.• When the printer is on, press the Power button  to put your printer in a Power Save state. Your printer consumes minimal power in this state.• When the printer is on or in the Power Save state, press and hold the Power button  for 2 seconds to turn your printer off. <p>NOTE: Do <i>not</i> unplug your printer from the electrical outlet when not in use. When the printer is off, it requires up to 1 watt of power to perform regular maintenance on cartridges.</p>
---	--------------	----------------------------------------------------------------------------------	-----------------------------------------------------------------------------------------------------------------------------------------------------------------------------------------------------------------------------------------------------------------------------------------------------------------------------------------------------------------------------------------------------------------------------------------------------------------------------------------------------------------------------------------------------------------------------------------------------------------------------------------------------------------------------------------------------------------------------------------------------------------------------------------------------------------------------------------------------------------------------------------------------------

Understanding the Software

- [Using the Dell All-In-One Center](#)
- [Using the Dell Fax Solutions Software](#)
- [Using Printing Preferences](#)
- [Using Memory Card Manager](#)
- [Dell Ink Management System](#)
- [Removing and Reinstalling Software](#)
- [Installing the Optional XPS Driver](#)

The printer software includes:

- **Dell All-In-One Center**– Allows you to perform various scan, copy, fax, and print operations with newly scanned and previously saved documents and images.
- **Dell Fax Solutions Software**– Allows you to fax electronic or scanned documents.
- **Printing Preferences**– Allows you to adjust printer settings.
- **Memory Card Manager**– Allows you to display, manage, edit, print, and scan photos from your memory card or USB memory key to your computer.
- **Dell Ink Management System™**– Warns you when your printer is running low on ink.
- **Corel® Snapfire™ Plus**– Allows you to view, manage, and edit photos stored on your computer.

Using the Dell All-In-One Center

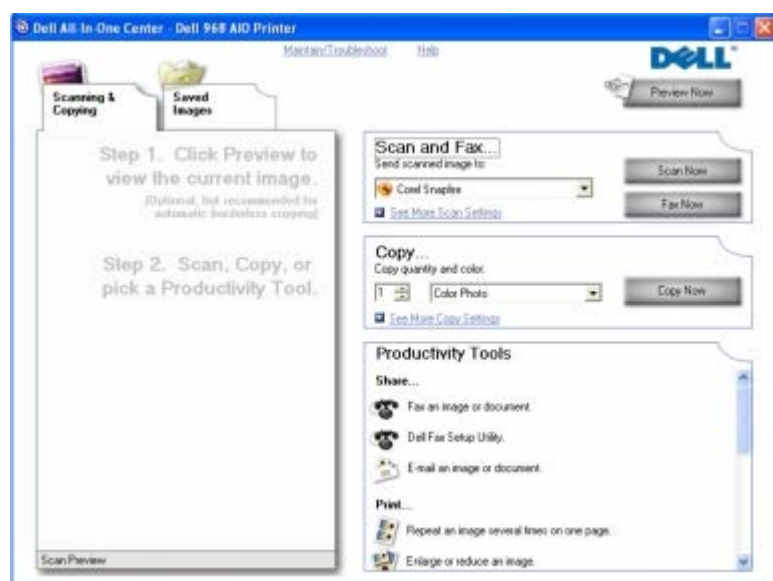

The **Dell All-In-One Center** allows you to:

- Scan, copy, fax, and use productivity tools.

- Select where you want to send the scanned image.
- Select the quantity and color of your copies.
- Access troubleshooting and maintenance information.
- Preview images you want to print or copy.
- Manage photos (copy them to folders, print them, perform creative copying).

 **NOTE:** If your printer is connected to a network using a wireless or Ethernet connection, you must start all scan and copy tasks from the printer operator panel instead of the Dell All-In-One Center.

To access the **Dell All-In-One Center**:

1. *In Windows Vista™:*

- Click  **Programs**.
- Click **Dell Printers**.
- Click **Dell 968 AIO Printer**.

In Windows® XP and Windows 2000:

Click **Start® Programs** or **All Programs® Dell Printers® Dell 968 AIO Printer**.

2. Select **Dell All-In-One Center**.

The Dell All-In-One Center includes four main sections:

In this section:	You can:
Preview Now	<ul style="list-style-type: none"> • Select a portion of the preview image to scan or copy. • View an image of what will be printed or copied.
Scan and Fax	<ul style="list-style-type: none"> • Select the program where you want to send the scanned image. • Select the type of image being scanned. • Select a quality setting for your scan. • Select Scan Now to scan your document or photo. • Select Fax Now to scan, and then fax a copy of your document or photo. <p>NOTE: Click See More Scan Settings to view all settings.</p>
Copy	<ul style="list-style-type: none"> • Select the number of copies. • Select the quality and color of your copies. • Select a quality setting for your copies. • Specify the blank paper size. • Specify the size of the original document being copied. • Lighten or darken your copies (this can also be accomplished using the operator panel).

- Resize your copies.
- Select **Copy Now** to create copies.

NOTE: Click **See More Copy Settings** to view all settings.

Productivity Tools

- Fax an image or document.
- Access the Dell Fax Setup Utility.
- E-mail an image or document.
- Repeat an image several times on one page.
- Resize an image.
- Print an image as a multi-page poster.
- Print more than one page on a sheet of paper.
- Save an image on your computer.
- Save multiple photos.
- Scan and save to PDF.
- Edit text found in a scanned document (Optical Character Recognition).
- Modify an image with a photo editor.

For more information, click **Help** in the **Dell All-In-One Center**.

Using the Dell Fax Solutions Software

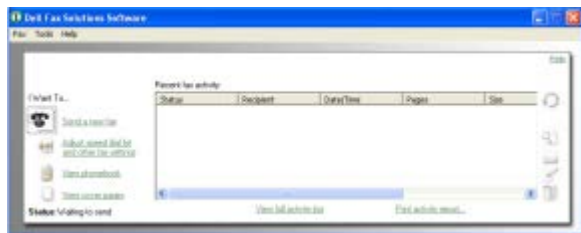

The **Dell Fax Solutions Software** allows you to:

- Send a fax.

Click **Send a new fax**, and then follow the instructions on the computer screen.

- Adjust other fax settings.

Click **Adjust speed dial list and other fax settings** to customize various fax settings.

- View and manage your phonebook.

Click **View phonebook** to open the Phone book. You can add, edit, or delete contact and group information. You can also add a contact or group to your speed dial list.

- View and customize cover page.

Click **View cover pages** to open the Cover Pages dialog. You can customize, add logos to, or choose from a variety of different ready-made cover pages for your fax.

- View fax history.

Click **View full activity log** to see or print a detailed list of all fax activity.

- Create a fax report.

Click **Print activity report** to see a detailed report of all fax activity. Click the **Print** icon to print your activity report.

 **NOTE:** If your printer is connected to a network using a wireless or Ethernet connection, you must start a scanned fax from the printer operator panel instead of the Dell Fax Solutions Software.

To access the Dell Fax Solutions Software:

1. *In Windows Vista:*

- a. Click  **Programs**.
- b. Click **Dell Printers**.
- c. Click **Dell 968 AIO Printer**.

In Windows XP and 2000:

Click **Start® Programs** or **All Programs® Dell Printers® Dell 968 AIO Printer**.

2. Click **Dell Fax Solutions**.

The **Dell Fax Solutions Software** dialog box opens.

Using Printing Preferences

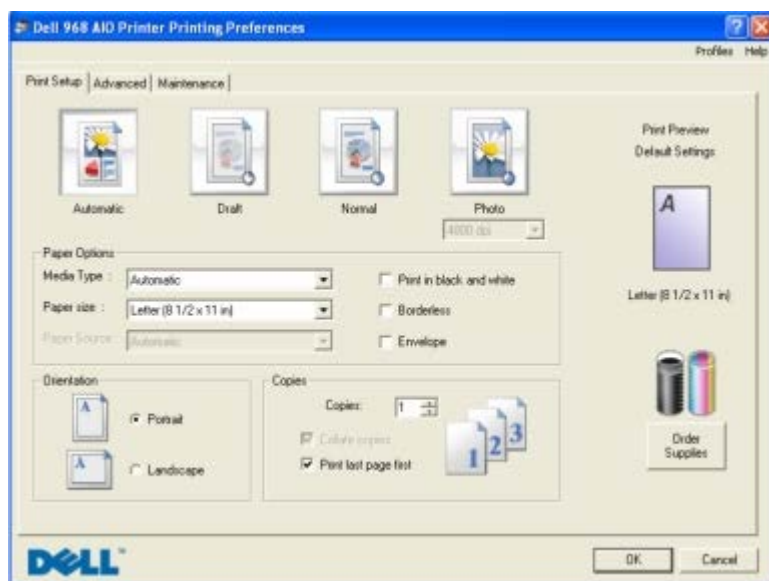

You can change your printer settings in Printing Preferences depending on the type of project you want to create.

To access Printing Preferences when a document is open:

1. Click **File® Print**.

The **Print** dialog box opens.

2. Click **Preferences, Properties, Options, or Setup** (depending on the program or operating system).

The **Printing Preferences** dialog box opens.

To access Printing Preferences when a document is not open:

1. *In Windows Vista:*

- a. Click  **Control Panel**.
- b. Click **Hardware and Sound**.
- c. Click **Printers**.

In Windows XP, click **Start® Settings® Control Panel® Printers and Other Hardware® Printers and Faxes**.

In Windows 2000, click **Start® Settings® Printers**.

2. Right-click the **Dell 968 AIO Printer** icon.
3. Click **Printing Preferences**.

 **NOTE:** Changes made to the printer settings from the **Printers** folder become the default settings for most programs.

The Printing Preferences dialog box has three sections:

Tab	Options
Print Setup	Quality/Speed — Select Automatic, Draft, Normal, or Photo depending on your desired output quality. Draft is the fastest option but should not be selected if you have a photo cartridge installed. If you select Photo, you can choose between 4800 dpi and 1200 dpi for glossy photo printing.
	Media Type — Allows you to set the paper type manually, or have the printer detect the paper type automatically.
	Paper Size — Select the size of your paper.
	Paper Source — Select Automatic, Tray 1/Bypass, or Tray 2 .
	NOTE: Paper Source is only available if an optional 2nd paper tray is attached to the printer.
	Print in black and white — Print your color images in black and white to save the ink in your color cartridge.
	NOTE: You cannot select this setting if you have selected Use Color Cartridge for all Black Printing .
	Borderless — Select the check box if you want to print borderless photos.
	Orientation — Select how the document is arranged on the printed page. You can print using portrait or landscape orientation.
Envelope — Select the check box if you want to print an envelope. The Paper Size area lists the envelope sizes available for printing.	

	Copies — Customize how the printer prints several copies of a single print job: Collated , Normal , or Print Last Page First .
Advanced	2-sided printing — Select this to print on both sides of the paper. Select from Automatic , Manual , or Print Duplex .
	Extend dry time — Select this option if you notice ink is smeared on the bottom of the pages of your duplex print jobs. This allows the ink on the paper to dry before the duplex unit feeds it back into the printer, and prints on the other side. NOTE: You will need to wait a few seconds longer for your duplex jobs to finish if your turn this feature on.
	Layout — Select Normal , Banner , Mirror , N-up , Poster , Booklet , or Borderless .
	Automatic Image Sharpening — Automatically select the best image-sharpening level based on image content.
	Dell Customer Experience Improvement Program — Allows you to access information about, and change your status in, the Dell Customer Experience Improvement Program.
	More Options — Allows you to specify Appearance Mode and Complete-A-Print settings. You can also view the paper type that the printer detects.
Maintenance	Install Ink Cartridges
	Clean Ink Cartridges
	Align Ink Cartridges
	Print a Test Page
	Network Support

Using Memory Card Manager

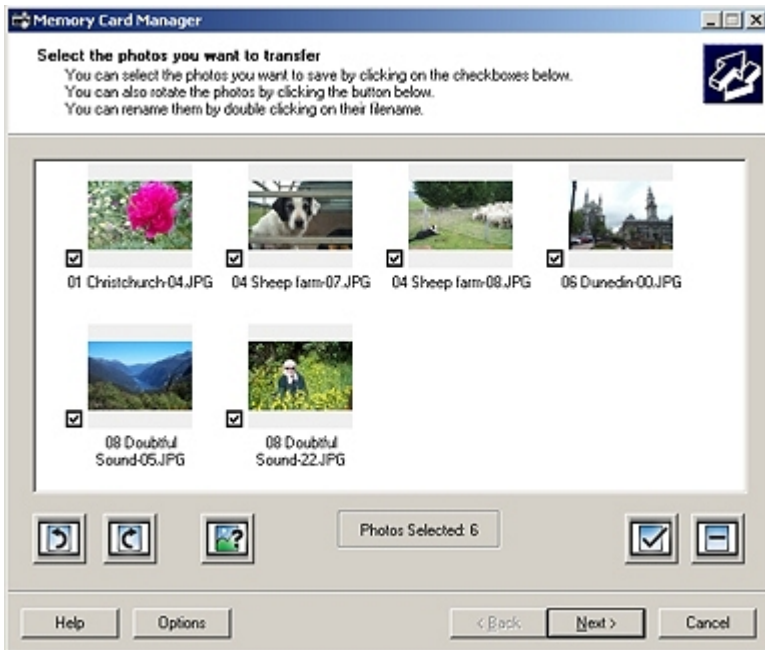

Memory Card Manager allows you to display, manage, edit, print, and save photos from your memory card or USB memory key to your computer.

To launch Memory Card Manager:

1. Insert a memory card into the memory card slot or a USB key into the PictBridge port on the front

of the printer.

- ➡ **NOTICE:** Do not remove the memory card or USB key, or touch the printer near the area of the memory card or USB key while actively reading, writing, or printing from these devices. Data corruption can occur.

2. *In Windows Vista:*

- a. Click  **Programs**.
- b. Click **Dell Printers**.
- c. Click **Dell 968 AIO Printer**.

In Windows XP and 2000:

Click **Start**® **Programs** or **All Programs**® **Dell Printers**® **Dell 968 AIO Printer**.

- 3. Select **Activate Memory Card Manager**.

Dell Ink Management System

Each time you print a job, a printing progress screen appears, which shows the progress of the print job as well as the amount of ink remaining and the approximate number of pages remaining in the cartridge. The page counter is hidden during the first 50 pages of cartridge use, until printing habits are learned and a more accurate count can be given. The number of pages remaining changes as a result of the type of print jobs the printer completes.

When your ink cartridge levels are low, a **Low Ink Warning** appears on your screen when you try to print. This warning is displayed every time you print until you install a new ink cartridge. For more information, see [Replacing Ink Cartridges](#).

When one or both of your ink cartridges are empty, the **Reserve Tank** window appears on your screen when you try to print. If you continue printing, the print job may not print as you expect.

If your black ink cartridge is out of ink, you can choose to print black from the color ink cartridge (Process Black) by selecting **Complete-A-Print** before clicking the **Continue Printing** button. If you select **Complete-A-Print** and click **Continue Printing**, Process Black is used for all black printing until the black cartridge is replaced, or the option is cleared from **More Options**, located on the **Advanced** tab of the **Printing Preferences**. The **Reserve Tank** dialog does not display again until after the low ink cartridge has been replaced. The **Complete-A-Print** check box is automatically reset when a new or different cartridge is installed.



If your color ink cartridge is out of ink, you can choose to print color documents in grayscale by

selecting **Complete-A-Print** before clicking the **Continue Printing** button. If you select **Complete-A-Print**, and click **Continue Printing**, all color documents will print in black and white until the color cartridge is replaced or the option is cleared from **More Options**, located on the **Advanced** tab of the **Printing Preferences**. The **Reserve Tank** dialog does not display again until after the low ink cartridge has been replaced. The **Complete-A-Print** check box is automatically reset when a new or different cartridge is installed.

Removing and Reinstalling Software

If your printer does not function properly, or communication error messages appear when using your printer, you can remove and reinstall the printer software.

1. *In Windows Vista:*

- a. Click  **Programs**.
- b. Click **Dell Printers**.
- c. Click **Dell 968 AIO Printer**.

In Windows XP and Windows 2000:

Click **Start**® **Programs** or **All Programs**® **Dell Printers**® **Dell 968 AIO Printer**.

2. Click **Uninstall Dell 968 AIO Printer**.
3. Follow the instructions on the screen.
4. Restart your computer.
5. Insert the Drivers and Utilities CD, and then follow the instructions on the screen.

If the installation screen does not appear:

- a. *In Windows Vista*, click  **Computer**.

In Windows XP, click **Start**® **My Computer**.

In Windows 2000, double-click **My Computer** from your desktop.

- b. Double-click the **CD-ROM drive** icon, and then double-click **setup.exe**.
 - c. When the printer software installation screen appears, click **Using a USB cable**, **Using a wireless network**, or **Using an Ethernet cable**.
 - d. Follow the instructions on your screen to complete the installation.
-

Installing the Optional XPS Driver

The XML Paper Specification (XPS) driver is an optional printer driver designed to make use of the advanced XPS color and graphics features that are only available for Windows Vista users. In order to use XPS features, you must install the XPS driver as an additional driver after you install your printer.

 **NOTE:** Before installing the XPS driver, complete the steps on the Setting Up Your Printer poster to install the printer on your computer.

 **NOTE:** Before installing the XPS driver, you must install the Microsoft QFE Patch and extract the

driver files from the Drivers and Utilities CD. To install the patch, you must have administrator privileges on the computer.

To install the Microsoft QFE Patch and extract the driver:

1. Insert the Drivers and Utilities CD, and then click **Cancel** when the Setup Wizard appears.
2. Click  **Computer**.
3. Double-click the **CD-ROM drive** icon, and then double-click **Drivers**.
4. Double-click **xps**, and then double-click **setupxps**.

XPS driver files are copied to your computer, and any required Microsoft XPS files are launched. Follow the instructions on the screen to finish installing the patch.

To install the driver:

1. Click  **Control Panel**.
2. Under **Hardware and Sound**, click **Printer**, and then click **Add a Printer**.
3. From the **Add Printer** dialog box, choose one of the following:
 - If you are using a USB connection, make sure the USB cable is connected to the computer and printer, and then do the following:
 - a. Click **Add a local printer**.
 - b. From the **Use an existing port:** drop-down menu, select **Virtual printer port for USB**, and then click **Next**.
 - If you are using an Ethernet or wireless connection, make sure the printer is connected to the network, and then do the following:
 - a. Click **Add a network, wireless or Bluetooth printer**.
 - b. Select your printer from the list.
 - c. If your printer is not in the list, click **The printer that I want isn't listed**.
 - d. Select **Add a printer using a TCP/IP address or hostname**, and then click **Next**.
 - e. To locate your printer IP address, print a Network Setup Page from the **Network Setup** menu under the **Setup** menu on the printer.
 - f. Type your printer IP address in the **Hostname or IP address:** box, and then click **Next**.
4. Click **Have disk**.

The **Install From Disk** dialog box opens.

5. Click **Browse**, and then navigate to the XPS driver files on your computer:
 - a. Click **Computer**, and then double-click **(C:)**.
 - b. Double-click **Drivers**, and then double-click **PRINTER**.
 - c. Double-click the folder that has your printer model number, and then double-click **Drivers**.

- d. Double-click **xps**, and then click **Open**.
 - e. From the **Install From Disk** dialog box, click **OK**.
6. Click **Next** on the following two dialog boxes.

For more information on the XPS driver, see the XPS **readme** file on the Drivers and Utilities CD. The file is located in the **xps** folder with the setupxps batch file (D:\Drivers\xps\readme).

Understanding the Operator Panel Menus

- [Copy Mode](#)
- [Photo Mode](#)
- [Print Files Mode](#)
- [Fax Mode](#)
- [Scan Mode](#)



- [Setup Mode](#)
- [Maintenance Mode](#)
- [PictBridge Mode](#)
- [Bluetooth Mode](#)

Copy Mode

Main Menu	Mode Main Menu	Mode Submenu
Copy	Color	
	Copies	
	Reduce/Enlarge	
	Quality	
	Lighter/Darker	
	Paper Handling	
	Collate	
	2-Sided Copies	
	N-up	
	Layout	
	Original Size	
	Content Type	
	Change Default Settings	Paper Handling

 **NOTE:** The **2-Sided Copies** menu only appears if the optional duplex unit is attached to the printer.

To view or change the **Copy Mode** menu:

1. From the main menu, press the up or down **Arrow** button   to scroll to Copy.
2. Press the **Select** button .

Copy menu item	Settings
Color	Specify the color of your copies. <ul style="list-style-type: none"> • Color* • Black & White
Copies	Specify the number of copies.

	1-99
Reduce/Enlarge	<p>Specify the size of the copies compared to the original document.</p> <ul style="list-style-type: none"> • 50% • 100%* • 200% • Custom% • Fit to Page • 2 x 2 Poster • 3 x 3 Poster • 4 x 4 Poster • Borderless
Quality	<p>Specify the copy quality.</p> <ul style="list-style-type: none"> • Auto* • Draft • Normal • Photo
Lighter/Darker	Press the left or right Arrow button < > to adjust the brightness.
Paper Handling	Press the Select button  to enter the Paper Handling menu, and then select the size and type of the blank paper loaded in the input tray. If you have an optional input tray, you can also specify the paper source. For more information, see Paper Handling Menu .
Collate	<p>Specify whether or not the printer should collate the copies.</p> <ul style="list-style-type: none"> • Off* • On
2-Sided Copies	<p>Select your preferred option for printing on both sides of the paper.</p> <ul style="list-style-type: none"> • 1-->1 (1-Sided Original, 1-Sided Copy)* • 1-->2 (1-Sided Original, 2-Sided Copy) • 2-->1 (2-Sided Original, 1-Sided Copy) • 2-->2 (2-Sided Original, 2-Sided Copy)
N-up	<p>Specify how many different images or pages of a document to print on a single page.</p> <ul style="list-style-type: none"> • 1-up* • 2-up

	<ul style="list-style-type: none"> • 4-up
Layout	<p>Specify how many times to repeat an image on a single page.</p> <ul style="list-style-type: none"> • 1 Per Page* • 4 Per Page • 9 Per Page • 16 Per Page
Original Size	<p>Specify the size of your original document.</p> <ul style="list-style-type: none"> • Auto Detect* • 8.5x11" • 2.25x3.25" • 3x5" • 3.5x5" • 4x6" • 4x8" • 5x7" • 8x10" • L • 2L • Hagaki • A6 • A5 • B5 • A4 • 60x80 mm • 9x13 cm • 10x15 cm • 10x20 cm • 13x18 cm • 20x25 cm
Content Type	<p>Specify the type of document you are copying.</p> <ul style="list-style-type: none"> • Auto*

	<ul style="list-style-type: none"> • Text & Graphics • Photo • Text Only • Line Drawing <p>For more information, see Smart Copy.</p>
Change Default Settings	Press the Select button  to enter the Copy Default Settings menu. For more information, see Copy Default Settings Menu .
* Factory default setting	

Smart Copy

Your printer is equipped with **Smart Copy**, a technology that enables the printer to automatically adjust the **Content Type** settings to improve the quality of your copies. When the **Content Type** is set to Auto (the default setting), the printer pre-scans each document before copying, and then optimizes the settings to provide richer colors, more neutral grays, sharper text, and more detailed pictures.

Photo Mode

Main Menu	Mode Main Menu	Mode Submenu	Mode Submenu
Photo	Browse and Print Photos	Edit Photo	
		View Full Screen	
		Change Print Settings	Paper Handling
		Print Preview	
	Select Computer		
	Photo Proof Sheet	Print Sheet with All X Photos	
		Print most recent 25 photos	
		Print Sheet Using Date Range	
		Scan Proof Sheet	
	Print All Photos		
	View Slide Show		
	Save Photos to Computer		
	Change Default Settings	Paper Handling	

 NOTE: The **Select Computer** menu only appears if the printer is connected to a network.

 NOTE: The **Print most recent 25 photos** option only appears if more than 25 photos are on your memory card or USB key.

Most digital cameras use a memory card to store photos. Your printer supports the following digital media:

- CompactFlash Type I and II

- Memory Stick
- Memory Stick PRO
- Memory Stick Duo (with adapter)
- Microdrive
- Secure Digital
- Secure Digital High Capacity
- Mini SD (with adapter)
- MultiMedia Card
- xD-Picture Card











To view or change the Photo mode settings:

1. Insert a memory card. The printer automatically switches to **Photo** mode after the card is read.

⚠ **NOTICE:** Do *not* remove the memory card or touch the printer in the area of the memory card while the light is blinking.

2. Press the **Select** button .

Photo Card Mode menu

Menu item	Settings
Browse and Print Photos	Press the Select button  to enter Photo Preview mode. Press the left or right Arrow button   to browse photos, or press the Start button  to print photos directly from the preview screen.
Select Computer	Press the Select button  to view a list of computers available on your network. NOTE: This menu is only available if the network adapter is attached and configured.
Photo Proof Sheet	Press the Select button  to enter the Photo Proof Sheet submenu. For more information, see Photo Proof Sheet Menu .
Print All Photos	Press the Select button  to enter the Print All Photos screen where you can specify the number of photos printed on a page. NOTE: Only photos stored in the JPG and a limited selection of TIFF formats can be printed directly from the memory card. If you want to print photos stored on the memory card in a different file format, the photos must be transferred to your computer before printing.
View Slideshow	Press the Select button  to enter the Slideshow menu where you can specify the speed of the slideshow of the photos on the memory card. Highlight the speed you want, and then press the Select button  to start the slideshow.
Save Photos to Computer	Press the Select button  to enter Save to PC mode. You can save the photos stored on the memory card to your computer or USB key, or you can save photos stored on the USB key to your computer or a memory card.
Change Default Settings	Press the Select button  to enter the Photo Default Settings menu. For more information, see Photo Print Settings Menu or Photo Default Settings Menu .



Print Camera Selection	Press the Select button  twice to display the selections that you made using your camera. For more information, see Camera Selection Preview . NOTE: This item is displayed only if there is a DPOF (Digital Print Order Format) selection in your memory card.
------------------------	-------------------------------------------------------------------------------------------------------------------------------------------------------------------------------------------------------------------------------------------------------------------------------------------------------------------------------------------------------------------------------

Photo More Options Menu

The **Photo More Options** menu is accessed by pressing the **Menu** button  while you have selected a photo in the **Photo Preview** mode.













Menu item	Settings
Edit Photo	Press the Select button  to enter the Photo Edit Mode menu. For more information, see Photo Edit Mode Menu .
View Full Screen	Press the Select button  to view the photo full-screen.
Change Print Settings	Press the Select button  to enter the Photo Default Settings menu. For more information, see Photo Print Settings Menu or Photo Default Settings Menu .
Print Preview	Press the Select button  to see a preview of the print job for the selected photo.

Photo Edit Mode Menu

You can access the **Photo Edit Mode** menu by selecting Edit Photo from the **Photo More Options** menu.

Menu item	Settings
Brightness	Press the left or right Arrow button   to specify a darkness setting (middle setting is default).
Rotate	Rotate the image 90° in the specified direction. <ul style="list-style-type: none"> • Clockwise * • Counter Clockwise 
Crop	Press the Select button  , and then press the left or right Arrow button   to choose the Shrink or Expand option  . Press the Select button  repeatedly to shrink or expand the area of interest box.
Auto Enhance	Specify whether or not the printer automatically adjusts the image. <ul style="list-style-type: none"> • Off* • On
Remove Red Eye	Specify whether or not the printer adjusts color in the image to eliminate red eye.

- No*
- Yes

* Factory default setting

Photo Print Settings Menu or Photo Default Settings Menu

You can access the **Photo Print Settings** menu by selecting Change Default Settings from the **Photo Card Mode** main menu or by selecting Change Print Settings from the **Photo More Options** menu.

Menu item	Settings
Photo Size	<p>Specify the size of your original photos.</p> <ul style="list-style-type: none"> • Automatic <p>NOTE: The setting changes to Automatic if the selected photo size cannot fit onto the layout specified.</p> <ul style="list-style-type: none"> • Hagaki • L • 2L • 60x80 mm • A6 • 10x15 cm • 13x18 cm • A5 • B5 • A4 • 2.25x3.25" • 3.5x5" • 4x6"* • 5x7" • 8x10" • 8.5x11"
Layout	<p>Specify the size of the printed photos.</p> <ul style="list-style-type: none"> • Automatic* • Borderless (1 per page)







	<ul style="list-style-type: none"> • One Photo Centered • 1 per page • 2 per page • 3 per page • 4 per page • 6 per page • 8 per page • 16 per page
Quality	<p>Specify the quality of your printed photos.</p> <ul style="list-style-type: none"> • Auto* • Draft • Normal • Photo
Paper Handling	<p>Press the Select button  to enter the Paper Handling menu, and then select the size and type of the blank paper loaded in the input tray. If you have an optional input tray, you can also specify the paper source. For more information, see Paper Handling Menu.</p>
* Factory default setting	



Photo Proof Sheet Menu

The **Photo Proof Sheet** menu is accessed by selecting Photo Proof Sheet from the **Photo Card Mode** main menu.

Menu item	Settings
Print Sheet with All X Photos	<p>Press the Select button  to print a proof sheet with all photos on the memory card or USB key.</p> <p>"X" is the number of photos detected on the memory card or USB key.</p>
Print most recent 25 photos	<p>Press the Select button  to print a proof sheet with the most recent 25 photos.</p>
Print Sheet Using Date Range	<p>Print only photos created in a certain date range.</p> <ol style="list-style-type: none"> 1. Press the Select button , and then choose a date range. 2. Press the Select button  to print the proof sheet.
Scan Proof Sheet	<p>Press the Select button  to scan a proof sheet after making your selections.</p>

Camera Selection Preview

The **Camera Selection Preview** is accessed by pressing the **Select** button  from the **Print Camera Selections** menu.

To navigate through the camera selections, press the left or right **Arrow** button . Press the **Start** button  to print the photos using the current print settings.

To alter the print settings, press the **Menu** button . From the **Photo Card Mode** menu, scroll to Change Photo Print Settings, and press the **Select** button .

Print Files Mode



Main Menu	Mode Main Menu
Print Files	Paper Handling

Use the **Print Files** mode to print documents stored on your USB key or memory card.

The printer recognizes files that have the following file extensions:

- .doc (Microsoft[®] Word)
- .xls (Microsoft Excel[®])
- .ppt (Microsoft PowerPoint[®])
- .pdf (Adobe[®] Portable Document Format)
- .rtf (Rich Text Format)
- .docx (Microsoft Word Open Document Format)
- .xlsx (Microsoft Excel Open Document Format)
- .pptx (Microsoft PowerPoint Open Document Format)
- .wps (Microsoft Works)
- .wpd (WordPerfect[®])

To view or change the **Print Files Mode** menu settings:

1. Make sure that the printer is connected to your computer that has Microsoft Office installed.
2. Insert a memory card into the card slots or a USB key into the PictBridge port.
3. Press the up or down **Arrow** button  to scroll to Print Files, and then press the **Select** button .

Print Files Mode Menu

Menu item	Settings
Paper	Press the Select button  to enter the Paper Handling menu, and then select the size



Handling and type of the blank paper loaded in the input tray. If you have an optional input tray, you can also specify the paper source. For more information, see [Paper Handling Menu](#).

* Factory default settings

Fax Mode

Main Menu	Mode Main Menu	Mode Submenu	Mode Submenu
Fax	Phone Book	Name Search	
		Phone Number Search	
		Add Entry	
		Group Search	
		Add Group	Name Search
		Phone Number Search	
		Redial History	
	Redial History		
	On Hook Dial		
	Delay Sending Fax		
	Auto Answer		
	Edit Fax Settings		
	Fax Setup	Speed Dial Phone Book	Phone Book
		History and Reports	
		Ringing and Answering	Auto Answer Schedule
		Fax Printing	Paper Handling
		Dialing and Sending	
		Fax Blocking	Blocked Fax Name Search
	Blocked Fax Add Entry		
	Print Blocked Fax Entry Number Search		

To view or change the **Fax Mode** menu:

1. From the main menu, press the up or down **Arrow** button   to scroll to Fax.
2. Press the **Select** button .







In order for faxing to function properly:

- The printer's FAX connector (FAX—left connector) must be connected to an active analog telephone line. See [Setting Up the Printer With External Devices](#) for setup details.

 **NOTE:** You cannot fax with a DSL (digital subscriber line) or ISDN (integrated signature digital network) unless you purchase a digital line filter. Contact your Internet Service Provider for more details.

- If you are using the **Fax Dell 968 AIO Printer** to send a fax from within an application, the printer must be connected to a computer with a USB cable.



Fax Options Menu



Menu item	Action
Fax Number Window	Use the keypad to enter the number to which you want to send a fax. The number displays in the window. NOTE: If you have already entered a number on the Fax main menu, then you can also use this window to enter another number and send a broadcast fax.
Phone Book	Press the Select button  to enter the Phone Book menu. For more information, see Phone Book Menu .
Redial History	Press the Select button  to view the redial history. The last five numbers dialed are displayed on the screen.
On Hook Dial	Press the Select button  to enter the On Hook Dial mode.
Delay Sending Fax	Press the Select button  to view the Delay Sending Fax screen. On this screen, use the keypad to specify the time you want the fax to be sent.
Auto Answer	Set your printer to answer incoming calls. <ul style="list-style-type: none"> • Off* • On • Scheduled—Press the Select button  to enter the Auto Answer Schedule menu. For more information, see Auto Answer Schedule Menu.
Edit Fax Settings	Press the Select button  to enter the Edit Fax Settings menu. For more information, see Edit Fax Settings Menu .
Fax Setup	Press the Select button  to enter the Fax Setup menu. For more information, see Fax Setup Menu .
* Factory default settings	

Phone Book Menu

The **Phone Book** menu is accessed by selecting Phone Book from the **Fax Mode** menu. You can also access this menu by selecting Speed Dial Phone Book from the **Fax Setup** menu.

You can specify up to 99 speed dial numbers—89 individual fax speed dial numbers and 10 group dial entries of up to 30 numbers each.

Menu item	Action
Name Search	Press the Select button  to enter the Name Search menu. For more information, see Name Search Menu .
Phone Number Search	Press the Select button  to enter the Phone Book Search menu. For more information, see Phone Number Search Menu .
Add Entry	Press the Select button  to enter the Phone Book: Add Entry menu. For more

	information, see Phone Book Add Entry Menu .
Group Search	Press the Select button  to enter the Group Search menu. For more information, see Group Search Menu .
Add Group	Press the Select button  to enter the Phone Book: Add Group menu. For more information, see Phone Book Add Group Menu .
Print List	Press the Select button  to print the phone book stored on your printer.

Name Search Menu

You can access the **Name Search** menu by selecting Name Search from the **Phone Book** menu.

Menu item	Action
Search Criteria Window	Use the keypad to enter a letter. The list automatically scrolls to the appropriate place in the phone book.
Speed dial	The names for the speed dial entries are shown. The number of speed dials listed depends on the number of speed dials you specified on your printer.

Phone Number Search Menu

You can access the **Phone Book Search** menu by selecting Phone Number Search from the **Phone Book** menu.

Menu item	Action
Search Criteria Window	Use the keypad to enter a number. The list automatically scrolls to the appropriate place in the phone book.
Speed dial	The fax numbers for the speed dial entries are shown. The number of speed dials listed depends on the number of speed dials you specified on your printer.

Phone Book Edit Entry Menu

You can access the **Phone Book: Edit Entry** menu by pressing the **Menu** button  when a speed dial number is highlighted in either the **Phone Number Search** or **Name Search** menus.

Menu item	Action
Name	Use the keypad to edit the name for the contact.
Fax Number	Use the keypad to edit the fax number for the contact.
Speed Dial Number	The speed dial number assigned to this contact is displayed. NOTE: The speed dial number is automatically assigned. You cannot modify the speed dial number.
Delete Entry	Press the Select button  to delete the entry from the phone book.

Phone Book Add Entry Menu

You can access the **Phone Book: Add Entry** menu by selecting Add Entry from the **Phone Book** menu.

Menu item	Action
Name	Use the keypad to enter the name for the contact.
Fax Number	Use the keypad to enter the fax number for the contact.
Speed Dial Number	The lowest available speed dial number is assigned for the contact. NOTE: The speed dial number is automatically assigned. You cannot modify the speed dial number.

Group Search Menu

You can access the **Group Search** menu by selecting Group Search from the **Phone Book** menu.

Menu item	Action
Search Criteria Window	Use the keypad to enter a letter.
Speed dial	The fax numbers for the group entries are shown. The number of groups listed depends on the number of groups specified in your printer.

Phone Book Edit Group Menu



You can access the **Phone Book: Edit Group** menu by pressing the **Menu** button  when a speed dial number is highlighted in the **Group Search** menu.

Menu item	Action
Name	Use the keypad to edit the name for the group.
Fax Number	Use the keypad to edit the fax numbers for the group.
Speed Dial Number	The speed dial number assigned to this group is displayed. NOTE: The speed dial number is automatically assigned. You cannot modify the speed dial number.
Delete Entry	Press the Select button  to delete the entry from the phone book.

Phone Book Add Group Menu

You can access the **Phone Book: Add Group** menu by selecting Add Group from the **Phone book** menu.

Menu item	Action
Name	Use the keypad to enter a name for the group.
Fax number window	Use the keypad to enter the fax numbers for the group.

Name Search	Press the Select button  to enter the Name Search menu. For more information, see Name Search Menu .
Phone Number Search	Press the Select button  to enter the Phone Book Search menu. For more information, see Phone Number Search Menu .
Redial History	Press the Select button  to display the redial history. The last five numbers dialed are displayed on the screen.
Speed Dial Number	The lowest available speed dial number is assigned to this group. NOTE: The speed dial number is automatically assigned. You cannot modify the speed dial number.

Auto Answer Schedule Menu

You can access the **Auto Answer Schedule** menu by selecting Scheduled from the Auto Answer option on the **Fax Mode** menu or by selecting Auto Answer Schedule from the **Ringling and Answering** menu.

When **Auto Answer** is turned on, the fax machine answers incoming faxes without user intervention. When **Auto Answer** is turned off, incoming faxes must be answered manually.



Menu item	Action
Current Time	Displays the current time.
Turn Auto Answer On at	Use the keypad to specify the time when you would like to turn Auto Answer on.
Turn Auto Answer Off at	Use the keypad to specify the time when you would like to turn Auto Answer off.

Edit Fax Settings Menu



You can access the **Edit Fax Settings** menu by selecting Edit Fax Settings from the **Fax Mode** menu.

The settings changed on this menu are temporary and will only be applicable to the fax job that you are sending at the time. They will not apply to your subsequent faxes.

Menu item	Action
Cover Page	Specify whether or not to send a cover page with your fax. <ul style="list-style-type: none"> • No* • Yes
Color	Specify the color of your sent fax. <ul style="list-style-type: none"> • Black & White* • Color
Quality	Specify the scan quality of your fax. <ul style="list-style-type: none"> • Standard*

	<ul style="list-style-type: none"> • Fine • Superfine • Ultrafine
Lighter/Darker	Press the left or right Arrow button   to specify a darkness setting (middle setting is default).
Original Size	Specify the size of your original document. <ul style="list-style-type: none"> • 8.5x11"* • A4
* Factory default settings	

Cover Page Menu

You can access the **Cover Page** menu by pressing the **Menu** button  when Cover Page is highlighted in the **Edit Fax Settings** menu. From the **Cover Page** menu, press the **Menu** button  to edit the contents of your cover page.

Menu item	Action
From #	Specify your fax number. <ul style="list-style-type: none"> • Leave Blank* • From #1 • From #2 • From #3 • From #4 • From #5 <p>NOTE: To assign or change information in the From menu, scroll to the option that you want to edit, and then press the Menu button . Use the keypad to enter information about the sender.</p>
Your Name	Displays the name of the sender.
Your Phone #	Displays the phone number of the sender.
Your Fax #	Use the keypad to enter your fax number.
Priority	Specify a priority level to display on your cover page. <ul style="list-style-type: none"> • None* • FYI • Please Reply







- Urgent

Message Use the keypad to enter your message for the recipient.

* Factory default settings





Fax Setup Menu

You can access the **Fax Setup** menu by selecting Fax Setup from the **Fax Mode** menu or by selecting Change Fax Default Settings from the **Setup** menu. The settings made on this menu apply to all fax jobs that you will send or receive, unless you restore the settings to factory defaults.

Menu item	Action
Speed Dial Phone Book	Press the Select button  to enter the Phone Book menu. For more information, see Phone Book Menu .
History and Reports	Press the Select button  to enter the History and Reports menu. For more information, see History and Reports Menu .
Ringing and Answering	Press the Select button  to enter the Ringing and Answering menu. For more information, see Ringing and Answering Menu .
Fax Printing	Press the Select button  to enter the Fax Printing menu. For more information, see Fax Printing Menu .
Dialing and Sending	Press the Select button  to enter the Dialing and Sending menu. For more information, see Dialing and Sending Menu .
Fax Blocking	Press the Select button  to enter the Fax Blocking menu. For more information, see Fax Blocking Menu .

History and Reports Menu





You can access the **History and Reports** menu by selecting History and Reports from the **Fax Setup** menu.

Menu item	Action
View History on Screen	Press the Select button  to display the fax history on the screen.
Print Sent History	Press the Select button  to print a history of sent faxes.
Print Received History	Press the Select button  to print a history of received faxes.
View Pending Faxes	Press the Select button  to display information about pending faxes on the screen.
Report	Specify when to print a fax history report. <ul style="list-style-type: none"> • Manual Print* • Every 40 Jobs
Print Fax Activity History	Press the Select button  to print a history of your fax activity.

Confirmation	Specify when to print a confirmation page for a fax. <ul style="list-style-type: none"> • On Error* • For All • Off
* Factory default settings	

Fax History More Options Menu

You can access the **Fax History More Options** menu by highlighting one of the numbers shown on the **Fax History** screen and pressing the **Select** button .

Menu item	Action
Redial This Number	Press the Select button  to enter the Fax Mode menu with the selected number displayed in the Fax Number Window.
Add Number to Phone Book	Press the Select button  to enter the Phone Book: Add Entry menu with the fax number field automatically populated with the current fax number.
Add Number to Blocked Faxes	Press the Select button  to enter the Blocked Fax: Add Entry menu with the fax number field automatically populated with the current fax number.
Clear All History	Press the Select button  to clear the fax activity log.

Ringling and Answering Menu

You can access the **Ringling and Answering** menu by selecting Ringling and Answering from the **Fax Setup** menu.

Menu item	Action
Ring Volume	Specify the volume of the fax modem ringer. <ul style="list-style-type: none"> • Low* • High • Off
Pick-up On	Specify the number of rings before your printer answers an incoming call. <ul style="list-style-type: none"> • 1st Ring • 2nd Ring • 3rd Ring* • 5th Ring
Distinctive Ring	Specify the distinctive ring setting that matches the option your phone service provides.

	<ul style="list-style-type: none"> • Any Ring* • Single Ring • Double Ring • Triple Ring
Auto Answer Schedule	Press the Select button <input checked="" type="radio"/> to enter the Auto Answer Schedule menu. For more information, see Auto Answer Schedule Menu .
Fax Forward	Set your printer to forward faxes or forward them and print a copy. <ul style="list-style-type: none"> • Off* • Forward • Print & Forward
Manual Pickup Key Code	Press the Select button <input checked="" type="radio"/> to display the Pickup Code menu. To change the code, use the keypad to specify a new code, and then press the Select button <input checked="" type="radio"/> . NOTE: The default code is DELL# (3355#) .
Caller ID Pattern	<ul style="list-style-type: none"> • Pattern 1 (FSK)* • Pattern 2 (DTMF) <p>NOTE: The Caller ID detection pattern is determined by the country or region you selected during initial setup. If phones in your country use two detection patterns, call your telecommunications company to know which pattern it subscribes to.</p>
* Factory default setting	

Fax Printing Menu

You can access the **Fax Printing** menu by selecting Fax Printing from the **Fax Setup** menu.

Menu item	Action
If Too Big	Specify how the printer handles incoming faxes that are too big to print on one page. <ul style="list-style-type: none"> • Fit to Page* • Use Two Pages
Fax Footer	Specify whether or not to include a footer on printed faxes. <ul style="list-style-type: none"> • On* • Off
2-Sided Print	Specify your duplex printing preference. <ul style="list-style-type: none"> • 1 Sided Print*

- 2 Sided Print

Paper Handling	Press the Select button  to enter the Paper Handling menu, and then select the size and type of the blank paper loaded in the input tray. If you have an optional input tray, you can also specify the paper source. For more information, see Paper Handling Menu .
----------------	-------------------------------------------------------------------------------------------------------------------------------------------------------------------------------------------------------------------------------------------------------------------------------------------------------------------------------------------------------------------------------------

* Factory default settings

Dialing and Sending Menu

You can access the **Dialing and Sending** menu by selecting Dialing and Sending from the **Fax Setup** menu.

Menu item	Action
Your Fax Number	Use the keypad to enter your fax number. This number is shown on the cover page of outgoing faxes.
Your Fax Name	Use the keypad to specify the name for the printer. This is the name shown on the fax header of outgoing faxes.
Cover Page	Specify whether or not to include a cover page on outgoing faxes. <ul style="list-style-type: none"> • No* • Yes
Color	Specify the color of your outgoing faxes. <ul style="list-style-type: none"> • Black & White* • Color
Quality	Specify the scan quality of your outgoing faxes. <ul style="list-style-type: none"> • Standard* • Fine • Superfine • Ultrafine
Lighter/Darker	Press the left or right Arrow button  to specify a darkness setting (middle setting is default).
Dial Method	Specify the dialing method that matches your phone system. <ul style="list-style-type: none"> • Touch-tone* • Pulse • Behind PBX (Dial Tone Detect Off)
Redial Time	Specify the time the printer waits before redialing failed faxes. <ul style="list-style-type: none"> • 1 Minute

	<ul style="list-style-type: none"> • 2 Minutes* • 3 Minutes • 4 Minutes • 5 Minutes • 6 Minutes • 7 Minutes • 8 Minutes
Redial Tries	<p>Specify the number of times the printer redials failed faxes.</p> <ul style="list-style-type: none"> • 0 Times • 1 Time • 2 Times • 3 Times* • 4 Times • 5 Times
Dial Prefix	<ul style="list-style-type: none"> • None*—Press the Select button <input checked="" type="checkbox"/> to change defaults. • Create—Press the Select button <input checked="" type="checkbox"/> to create a prefix if one is necessary to obtain an outside line. • Modify—Press the Select button <input checked="" type="checkbox"/> to modify your existing prefix.
Dial Volume	<p>Specify the dial volume of the fax modem.</p> <ul style="list-style-type: none"> • Off • Low* • High
Scan	<ul style="list-style-type: none"> • Before Dial*—the fax is scanned to memory before dialing the fax number. • After Dial—the fax number is dialed, communication with receiving fax is established, and then the fax is scanned.
Max Send Speed	<p>Specify the maximum data speed your phone system will allow.</p> <ul style="list-style-type: none"> • 33,600 bps* • 31,200 bps • 28,800 bps • 26,400 bps





	<p>24,000 bps</p> <ul style="list-style-type: none"> • 21,600 bps • 19,200 bps • 16,800 bps • 14,400 bps • 12,000 bps • 9,600 bps • 7,200 bps • 4,800 bps • 2,400 bps
Auto Fax Conversion	<ul style="list-style-type: none"> • On*—the fax is automatically converted to be compatible with the receiving fax machine regardless of the send settings. • Off—an unsupported fax error is given if there is a mismatch between send settings and those on the receiving fax machine.
Error Correction	<p>Specify whether or not the printer should attempt to automatically correct data errors in faxes.</p> <ul style="list-style-type: none"> • On* • Off
Original Size	<p>Specify the original size of your faxes.</p> <ul style="list-style-type: none"> • 8.5x11"* • A4
* Factory default settings	

Fax Blocking Menu

You can access the **Fax Blocking** menu by selecting Fax Blocking from the **Fax Setup** menu.

When fax blocking is on, calls received from fax machines that have a caller ID that matches one specified on the block list or have blocked their caller ID are disconnected.

Menu item	Action
Block List	<p>Turn the fax blocking feature on or off.</p> <ul style="list-style-type: none"> • Off* • On
Block No-ID	Specify whether or not the printer accepts faxes from unknown senders.

	<ul style="list-style-type: none"> • Off* • On
Blocked Fax Name Search	Press the Select button  to enter the Blocked Fax Name Search menu. For more information, see Blocked Fax Name Search Menu .
Blocked Fax Entry Number Search	Press the Select button  to enter the Blocked Fax Number Search menu. For more information, see Blocked Fax Entry Number Search Menu .
Blocked Fax Add Entry	Press the Select button  to enter the Blocked Fax: Add Entry menu. For more information, see Blocked Fax Add Entry Menu .
Print Blocked Fax List	Press the Select button  to print the contents of the blocked fax list.
* Factory default settings	

Blocked Fax Name Search Menu

You can access the **Blocked Fax Name Search** menu by selecting Blocked Fax Name Search from the **Fax Blocking** menu.

Menu item	Action
Search Window Criteria	Use the keypad to enter a letter. The list automatically scrolls to the appropriate place in the phone book.
Blocked Fax List Value	The contact being blocked is displayed. The number of contacts on the list depends on the number of fax numbers you have blocked.

Blocked Fax Entry Number Search Menu

You can access the **Blocked Fax Entry Number Search** menu by selecting Blocked Fax Entry Number Search from the **Fax Blocking** menu.

Menu item	Action
Search Criteria Window	Use the keypad to enter a number. The list automatically scrolls to the appropriate place in the phone book.
Blocked Fax List Number	The number assigned to the fax number being blocked is displayed. The number assigned to the blocked fax list depends on the number of fax numbers you have blocked.

Blocked Fax Edit Entry Menu

You can access the **Blocked Fax Edit Entry** menu by pressing the **Menu** button  while a number is highlighted in the **Blocked Fax Name Search** or **Blocked Fax Entry Number Search** menus.

Menu item	Action
Name	Use the keypad to edit the name for the contact.

Fax Number	Use the keypad to edit the fax number for the contact.
Blocked Fax #	A number is assigned to this blocked fax number. NOTE: The number is automatically assigned. You cannot modify the assigned number.
Delete Entry	Press the Select button  to delete this entry from the blocked fax list.

Blocked Fax Add Entry Menu

You can access the **Blocked Fax Add Entry** menu by selecting Blocked Fax Add Entry from the **Fax Blocking** menu.





You can add up to 50 numbers to the blocked fax list.

Menu item	Action
Name	Use the keypad to edit the name for the contact.
Fax Number	Use the keypad to edit the fax number for the contact. It is required to enter a number to add an entry from this menu.
Blocked Fax #	A number is assigned to this blocked fax number. NOTE: The number is automatically assigned. You cannot modify the assigned number.

Scan Mode

Main Menu	Mode Main Menu
Scan	Scan To
	Color
	Quality
	Original Size
	Change Scan Default Settings

To view or change the **Scan Mode** menu settings:

1. Ensure your printer and computer are connected via a USB cable.
2. From the main menu, press the up or down **Arrow** button   to scroll to Scan, and then press the **Select** button .
3. If your computer is connected to a network, select a host from the **Host Selection** screen, and enter a four-digit PIN number, if necessary, for the selected host.
4. Press the **Select** button .

Scan Mode Menu



Menu item	Settings
Scan To	Select the program to which to send your scan.

	<ul style="list-style-type: none"> • Preview • Email • File • software installed on your computer
Color	<p>Specify the color of your scan.</p> <ul style="list-style-type: none"> • Color* • Black & White
Quality	<p>Specify the quality (resolution) of your scan.</p> <ul style="list-style-type: none"> • Automatic* • 150 dpi • 300 dpi • 600 dpi
Original Size	<p>Specify the size of your original document or image.</p> <ul style="list-style-type: none"> • Auto Detect* • L • 2L • A6 • A5 • B5 • A4 • 2.25x3.25" • 3x5" • 4x6" • 5x7" • 8x10" • 8.5x11"
Change Default Settings	<p>Press the Select button  to enter the Scan Default Settings menu. For more information, see Scan Default Settings Menu.</p>
* Factory default settings	



Setup Mode









Main Menu	Mode Main Menu	Mode Submenu	Mode Submenu
Setup	Paper Handling		
	Change Printer Default Settings	Set Date and Time	
		Paper Handling	
	Change Copy Default Settings	Paper Handling	
	Change Photo Default Settings	Paper Handling	
	Change Fax Default Settings	Speed Dial Phone Book	Phone Book
		History and Reports	
		Ringing and Answering	Auto Answer Schedule
		Fax Printing	Paper Handling
		Dialing and Sending	
		Fax Blocking	Blocked Fax Name Search
			Blocked Fax Entry Number Search
			Blocked Fax Add Entry
	Change Scan Default Settings		
	Change Bluetooth Default Settings	Paper Handling	
	Change PictBridge Default Settings	Paper Handling	
	Print Settings List		
	Network Setup	Wireless Menu	Wireless Signal Quality
		TCP/IP	Set IP Address
			Set IP Netmask
Set IP Gateway			
Network Time Menu			

To access the **Setup** menu:

1. From the main menu, press the up or down **Arrow** button   to scroll to Setup.
2. Press the **Select** button .

Setup Mode Menu

Menu item	Action
Paper Handling	Press the Select button  to enter the Paper Handling menu. For more information, see Paper Handling Menu .
Change Printer	Press the Select button  to enter the Printer Default Settings menu. For

Default Settings	more information, see Printer Default Settings Menu .
Change Copy Default Settings	Press the Select button  to enter the Copy Default Settings menu. For more information, see Copy Default Settings Menu .
Change Photo Default Settings	Press the Select button  to enter the Photo Default Settings menu. For more information, see Photo Default Settings Menu .
Change Fax Default Settings	Press the Select button  to enter the Fax Setup menu. For more information, see Fax Setup Menu .
Change Scan Default Settings	Press the Select button  to enter the Scan Default Settings menu. For more information, see Scan Default Settings Menu .
Change Bluetooth Default Settings	Press the Select button  to enter the Bluetooth Default Settings menu. For more information, see Bluetooth Default Settings Menu .
Change PictBridge Default Settings	Press the Select button  to enter the PictBridge Default Settings menu. For more information, see PictBridge Default Settings Menu .
Print Settings List	Press the Select button  to print a list of the options that were set using the operator panel.
Network Setup	Press the Select button  to enter the Network Setup menu. For more information, see Network Setup Menu .

Paper Handling Menu

You can select the size and type of the blank paper loaded in the input tray from the **Paper Handling** menu. If you have an optional input tray, you can also specify the paper source.

You can view or change the **Paper Handling** menu by selecting Paper Handling from the **Setup** menu, **Copy Mode** menu, **Photo Print Settings** menu, **Photo Default Settings** menu, **Print File Default Settings** menu, **Fax Printing** menu, or **Bluetooth Default Settings** menu.

Paper Handling menu for printer with one input tray

Menu item	Settings
Size	<p>Specify the size of the paper loaded in the input tray.</p> <ul style="list-style-type: none"> • 8.5x11"* • 8.5x14" • A4* • B5 • A5 • A6 • L • 2L • Hagaki • 3x5"

- 3.5x5"
- 4x6"
- 4x8"
- 5x7"
- 10x15 cm
- 10x20 cm
- 13x18 cm

NOTE: Size is determined by the country you selected during initial setup. Changing size from any menu changes the option selected in all other menus.

Type Specify the type of paper loaded in the input tray.

- Auto Detect*
- Plain
- Matte
- Photo
- Transparency

* Factory default setting





Additional options available when a second paper tray is attached

Menu item	Settings
Size- Tray 2	Tray 1 and Tray 2 have the same default paper size during the initial setup. You can load different sizes of paper into these two trays and choose the corresponding paper size options for them. Tray 2 has the same size options as Tray 1.
Type- Tray 2	Tray 2 has the same paper type options as Tray 1.
Tray Linking	Specify whether or not the printer pulls paper from the second tray if the first tray is empty. <ul style="list-style-type: none"> • Off* • Auto For more information, see Understanding Tray Linking .
Copy Source	Specify the paper source for making copies. <ul style="list-style-type: none"> • Tray1* • Tray2
Photo Source	Specify the paper source for printing photos.

	<ul style="list-style-type: none"> • Tray1* • Tray2
Print Files Source	<p>Specify the paper source for printing files.</p> <ul style="list-style-type: none"> • Tray1* • Tray2
Fax Source	<p>Specify the paper source for printing faxes.</p> <ul style="list-style-type: none"> • Tray1* • Tray2 • Auto <p>NOTE: Select Auto if you want the printer to pick from the tray containing the paper that matches the size of the incoming fax. You also need to specify the correct paper size for both trays.</p>
PictBridge Source	<p>Specify the paper source for printing photos from a PictBridge-enabled camera.</p> <ul style="list-style-type: none"> • Tray1* • Tray2
Bluetooth Source	<p>Specify the paper source for printing files from a Bluetooth-enabled device.</p> <ul style="list-style-type: none"> • Tray1* • Tray2
* Factory default setting	

Printer Default Settings Menu

You can view or change the **Printer Default Settings** by selecting Change Printer Default Settings from the **Setup** menu.

Menu item	Settings
Set Date and Time	Press the Select button  , and then use the keypad to enter the current date and time. Press the left or right Arrow button  to move to the next entry field.
Paper Handling	Press the Select button  to enter the Paper Handling menu. For more information, see Paper Handling Menu .
Language	Press the left or right Arrow button  to scroll through the language options.
Country	Press the left or right Arrow button  to scroll through the country options.
Key Press Tone	<p>Specify whether or not a tone sounds when you press the operator panel buttons.</p> <ul style="list-style-type: none"> • Off

	<ul style="list-style-type: none"> • On*
Power Save	<p>Specify when the printer enters Power Save mode.</p> <ul style="list-style-type: none"> • Now • After 10 min • After 30 min* • After 60 min • After 120 min • After 240 min
Block Host Settings	<ul style="list-style-type: none"> • Off* • On <p>NOTE: Set Block Host Settings to On if you want to prevent other users from changing the settings of your printer.</p>
Speaker Volume	<p>Specify the volume level for the printer speaker.</p> <ul style="list-style-type: none"> • Off • Low* • High
* Factory default setting	

Copy Default Settings Menu

You can view or change the **Copy Default Settings** by selecting Copy Default Settings from the **Setup** menu or by selecting Change Default Settings from the **Copy Mode** menu.

Menu item	Settings
Color	<p>Specify the color of copies.</p> <ul style="list-style-type: none"> • Color* • Black & White
Quality	<p>Specify the copy quality.</p> <ul style="list-style-type: none"> • Auto* • Draft • Normal • Photo
Original	Specify the size of your original documents.

Size	<ul style="list-style-type: none"> • Auto Detect* • 8.5x11" • 2.25x3.25" • 3x5" • 3.5x5" • 4x6" • 4x8" • 5x7" • 8x10" • L • 2L • Hagaki • A6 • A5 • B5 • A4 • 60x80 mm • 9x13 cm • 10x15 cm • 10x20 cm • 13x18 cm • 20x25 cm
Content Type	<p>Specify the type of document you are copying.</p> <ul style="list-style-type: none"> • Text & Graphics* • Photo • Text Only • Line Drawing
2-sided Original	<p>Specify whether your original document is printed on one or both sides of the page.</p> <ul style="list-style-type: none"> • Off* • On

Paper Handling | Press the **Select** button  to enter the **Paper Handling** menu. For more information, see [Paper Handling Menu](#).

* Factory default setting

Photo Default Settings Menu

You can view or change the **Photo Default Settings** by selecting Change Photo Default Settings from the **Setup** menu or by selecting Change Default Settings from the **Photo Card Mode** menu. The settings made on this menu apply to all photos that will be printed, unless you restore the settings to factory defaults.

Menu item	Settings
Photo Size	<p>Specify the size of your original photos.</p> <ul style="list-style-type: none">• Hagaki• L• 2L• 60x80 mm• A6• 10x15 cm• 13x18 cm• A5• B5• A4• 2.25x 3.25"• 3.5x 5"• 4x6"• 5x7"• 8x10"• 8.5x11"
Layout	<p>Specify the size of the printed photos.</p> <ul style="list-style-type: none">• Automatic*• Borderless (1 per page)• One Photo Centered• 1 per page• 2 per page

	<ul style="list-style-type: none"> • 3 per page • 4 per page • 6 per page • 8 per page • 16 per page
Quality	<p>Specify the quality of your printed photos.</p> <ul style="list-style-type: none"> • Auto* • Draft • Normal • Photo
Paper Handling	<p>Press the Select button  to enter the Paper Handling menu. For more information, see Paper Handling Menu.</p>
* Factory default setting	

Fax Setup Menu

You can access the **Fax Setup** menu by selecting Change Fax Default Settings from the **Setup** menu or by selecting Fax Setup from the **Fax Mode** menu. For more information, see [Fax Setup Menu](#).

Scan Default Settings Menu

You can view or change the **Scan Default Settings** by selecting Change Scan Default Settings from the **Setup** menu or by selecting Change Default Settings from the **Scan Mode** menu.

Menu item	Settings
Color	<p>Specify the color of your scans.</p> <ul style="list-style-type: none"> • Color* • Black & White
Quality	<p>Specify the quality (resolution) of your scans.</p> <ul style="list-style-type: none"> • Automatic* • 150 dpi • 300 dpi • 600 dpi
Original Size	<p>Specify the size of your original documents or images.</p> <ul style="list-style-type: none"> • Auto Detect*

- L
- 2L
- A6
- A5
- B5
- A4
- 2.25x3.25"
- 3x5"
- 4x6"
- 4x8"
- 5x7"
- 8x10"
- 8.5x11"

* Factory default setting

Bluetooth Default Settings Menu





You can view or change the **Bluetooth Default Settings** by selecting Change Bluetooth Default Settings from the **Setup** menu. For more information, see [Bluetooth Mode](#).



PictBridge Default Settings Menu

You can view or change the **PictBridge Default Settings** by selecting Change PictBridge Default Settings from the **Setup** menu. For more information, see [PictBridge Mode](#).

Network Setup Menu

You can access **Setup** menu by selecting Network Setup from the **Setup** menu.

Menu item	Settings
Reset Network Adapter Defaults	Press the Select button  to reset all wireless settings to default.
Print Network Setup Page	Press the Select button  to print a list of network settings.
Wireless Menu	Press the Select button  to enter the Wireless Setup Menu . For more information, see Wireless Menu .
TCP/IP	Press the Select button  to enter the TCP/IP Menu . For more information, see TCP/IP Menu .
Network Time Menu	Press the Select button  to enter Network Time Menu .

From the Network Time Menu, press the left or right **Arrow** button   to enable or disable the **Time Server**, and then press the **Back** button  to save the settings.

NOTE: When **Time Server** is enabled, the wireless Ethernet card updates the printer's time once a day or every time the printer is powered on.

Active Network	Specify which network connection the adapter should use. <ul style="list-style-type: none"> • Auto* • Ethernet 10/100 • Wireless 802.11b/g
----------------	-----------------------------------------------------------------------------------------------------------------------------------------------------------------------------

* Factory default setting





Wireless Menu

You can view or change the settings in the **Wireless Setup Menu** by selecting Wireless Menu from the **Network Setup** menu.

Menu item	Settings
Network Name	Reflects the current SSID being used. NOTE: You cannot change the value of Network Name.
Wireless Signal Quality	Press the Select button  to view the current signal quality.
* Factory default setting	

TCP/IP Menu

You can view or change the settings in the **TCP/IP Menu** by selecting TCP/IP from the **Network Setup** menu.

Menu item	Settings
Enable DHCP	Specify whether or not your network automatically assigns IP settings. <ul style="list-style-type: none"> • Yes* • No NOTE: You cannot change or set an IP Address, IP Netmask, and IP Gateway if DHCP is enabled.
Set IP Address	Press the Select button  to enter the Set IP Address menu. From the Set IP Address menu, use the keypad to enter an IP address. Press the right Arrow button  to enter a set of numbers in the next field, or press the left Arrow button  to erase an entry. Press the Back button  to save the settings. NOTE: The IP address cannot be changed if DHCP is enabled.
Set IP Netmask	Press the Select button  to enter the Set IP Netmask menu.

From the **Set IP Netmask** menu, use the keypad to enter an IP address. Press the right **Arrow** button **>** to enter a set of numbers in the next field, or press the left **Arrow** button **<** to erase an entry. Press the **Back** button  to save the settings.

NOTE: The IP netmask cannot be changed if DHCP is enabled.

Set IP Gateway

Press the **Select** button  to enter the **Set IP Gateway** menu.

From the **Set IP Gateway** menu, use the keypad to enter an IP address. Press the right **Arrow** button **>** to enter a set of numbers in the next field, or press the left **Arrow** button **<** to erase an entry. Press the **Back** button  to save the settings.

NOTE: The IP gateway cannot be changed if DHCP is enabled.

* Factory default setting





Maintenance Mode

Main Menu	Mode Main Menu
Maintenance	View Ink Levels
	Clean Cartridges
	Align Cartridges
	Change Print Cartridges
	Print Test Page
	Call Diagnostics
	Reset Defaults

To access **Maintenance** mode options:

1. From the main menu, press the up or down **Arrow** button **^**/**v** to scroll to Maintenance.
2. Press the **Select** button .

Maintenance Mode Menu

Menu item	Action
View Ink Levels	Press the Select button  to display the current ink level for each cartridge on the screen.
Clean Cartridges	Press the Select button  to clean the ink cartridges.
Align Cartridges	Press the Select button  to align the ink cartridges.
Change Print Cartridges	Press the Select button  to view steps detailing how to change ink cartridges.
Print Test Page	Press the Select button  to print a test page.
Call Diagnostics	Specify how your printer treats automatic calls for diagnostic support. <ul style="list-style-type: none"> • Off*

	<ul style="list-style-type: none"> • Audio on • Print T30 Signals Report • Both Audio and Report
Reset Defaults	Press the Select button  to reset all settings to factory default settings.
* Factory default setting	

PictBridge Mode

Main Menu	Mode Main Menu
PictBridge Default Print Settings	Photo Size
	Layout
	Quality
	Paper Handling

Your printer automatically switches to **PictBridge** mode when you connect a PictBridge-enabled camera. You can print pictures using the controls of the camera. For more information, see [Printing Photos From a PictBridge-Enabled Camera](#).

To view or change the **PictBridge** default print settings, press the **Menu** button .

PictBridge Default Print Settings Menu

Menu item	Settings
Photo Size	Specify the size of your original photos. <ul style="list-style-type: none"> • Hagaki • L • 2L • 60x80mm • A6 • 10x15cm • 13x18cm • A5 • B5 • A4 • 2.25x 3.25" • 3.5x5"

	<ul style="list-style-type: none"> • 4x6" • 5x7" • 8x10" • 8.5x11" <p>NOTE: Photo Size is determined by the country or region you selected during initial setup.</p>
Layout	<p>Specify the size of the printed photos.</p> <ul style="list-style-type: none"> • Automatic* • Borderless (1 per page) • One Photo Centered • 1 per page • 2 per page • 3 per page • 4 per page • 6 per page • 8 per page • 16 per page
Quality	<p>Specify the quality of your printed photos.</p> <ul style="list-style-type: none"> • Auto* • Draft • Normal • Photo
Paper Handling	<p>Press the Select button  to enter the Paper Handling menu, and then select the size and type of the blank paper loaded in the input tray. If you have an optional input tray, you can also specify the paper source. For more information, see Paper Handling Menu.</p>
* Factory default setting	







Bluetooth Mode

Main Menu	Mode Main Menu
Bluetooth Default Settings	Bluetooth Enabled
	Discovery Mode
	Security

	Pass Key
	Trusted Devices–Clear All
	Device Name
	Device Address
	Paper Handling

To print from an external Bluetooth-enabled device, you must attach a USB Bluetooth adapter to the PictBridge port. The Bluetooth icon  appears on the display once the USB Bluetooth adapter is active.

To view or change **Bluetooth Default Settings**:

1. Press the up or down **Arrow** button   to scroll to Setup, and then press the **Select** button .
2. Press the up or down **Arrow** button   to scroll to Change Bluetooth Default Settings, and then press the **Select** button .

Bluetooth Default Settings Menu

Menu item	Settings
Bluetooth Enabled	<ul style="list-style-type: none"> • On* • Off <p>NOTE: When Bluetooth Enabled is set to On, the printer accepts Bluetooth connections and allows the USB Bluetooth adapter to communicate with other Bluetooth-enabled devices.</p>
Discovery Mode	<ul style="list-style-type: none"> • On* • Off <p>NOTE: Set the Discovery Mode to On if you want other Bluetooth-enabled devices to detect the USB Bluetooth adapter attached to your printer.</p>
Security	<p>Specify your preferred security level.</p> <ul style="list-style-type: none"> • Low* • High
Pass Key	<p>Specify a pass key. Any external Bluetooth-enabled device needs to enter this pass key before it sends a print job.</p> <p>NOTE: You only need to specify a pass key if the Security Level is set to High.</p>
Trusted Device-Clear All	<p>Press the Select button  to clear the list of trusted devices.</p> <p>NOTE: Your printer stores a maximum of eight external Bluetooth-enabled devices (trusted devices). When the printer detects more than eight devices, the least recently used device is removed from the list.</p>
Device Name	<p>The name assigned to the USB Bluetooth adapter. When printing from an external Bluetooth-enabled device, the Device Name or Device Address should be selected.</p>
Device	<p>The address of your USB Bluetooth adapter. When printing from an external Bluetooth-</p>

Address	enabled device, the Device Name or Device Address should be selected. NOTE: You cannot change the Device Address .
Paper Handling	Press the Select button  to enter the Paper Handling menu, and then select the size and type of the blank paper loaded in the input tray. If you have an optional input tray, you can also specify the paper source. For more information, see Paper Handling Menu .
*Factory default setting	

Networking

- [Minimum Requirements for Setup](#)
- [Wireless Network Settings](#)
- [Wireless Encryption](#)
- [Installing and Configuring the Dell Internal Network Adapter 1150](#)
- [Configuring the Adapter Using the Wireless Setup Utility](#)

The optional Dell™ Internal Network Adapter 1150 enables you to connect your printer to a network using a wireless or Ethernet connection.

 NOTE: The Dell Internal Network Adapter 1150 may not be available in all regions. Check with your local Dell Sales Representative to determine availability.

Minimum Requirements for Setup

- The Dell Internal Network Adapter 1150
 - The Dell All-In-One Printer
 - An existing wireless network
 - The Drivers and Utilities CD that shipped with your printer
 - A computer running one of the following operating systems:
 - Windows Vista™
 - Microsoft® Windows® XP
 - Microsoft Windows 2000
-

Wireless Network Settings

Some wireless network settings may be needed to configure the adapter that has been installed in the printer. Here are some of the settings that you may need:

- Network Name, also known as SSID (Service Set ID)
 - BSS (Basic Service Set) Type (the type of wireless network you use—Ad-Hoc or Infrastructure)
 - Wireless Channel Number
 - Network Authentication and encryption type
 - Security Key(s)
-

Wireless Encryption

The following security types are supported:

- No security
- WEP with either 64-bit or 128-bit key
- WPA with 128-bit TKIP encryption engine
- WPA2 with 128-bit AES-CCMP encryption engine

A WPA (WiFi Protected Access) pre-shared key is like a password and must meet the following criteria:

- If you are using Hexadecimal characters, valid keys are 64 characters long.
- If you are using ASCII, valid keys are at least 8 characters long.

The wireless network may use anywhere from one to four WEP keys. A WEP key is like a password and must meet the following criteria:

- If you are using Hexadecimal characters, valid keys are either 10 or 26 characters long.
- If you are using ASCII, valid keys are either 5 or 13 characters long.

Installing and Configuring the Dell Internal Network Adapter 1150

Installing the Adapter

 **NOTE:** If your printer came with the Dell Internal Network Adapter 1150 pre-installed, go to [Configuring the Adapter for a Wireless Connection](#) or [Configuring the Adapter for an Ethernet Connection](#).

1. Turn off your printer, and then unplug the power cable from the wall outlet.

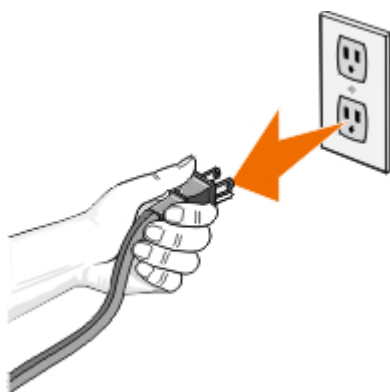

 **NOTICE:** Failure to unplug the printer can cause damage to your printer and adapter.

2. Remove the back cover.

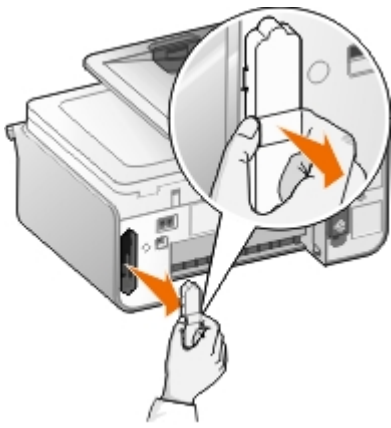

⚠ **NOTICE:** Your wireless adapter is easily damaged by static electricity. Touch a grounded metal object before you touch the adapter.

3. Remove the Dell Internal Network Adapter 1150 from the packaging.

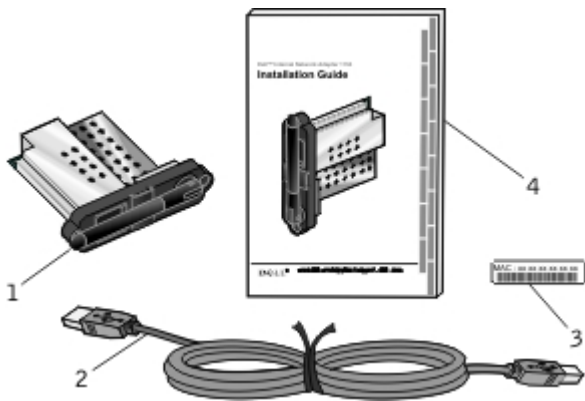

Callout	Item
1	Dell Internal Network Adapter 1150
2	USB cable
3	MAC address label
4	Dell Internal Network Adapter 1150 Installation Guide

4. Attach the MAC address label to the back of your printer.

5. Insert the adapter into the slot until it is pressed evenly against the back of the printer.

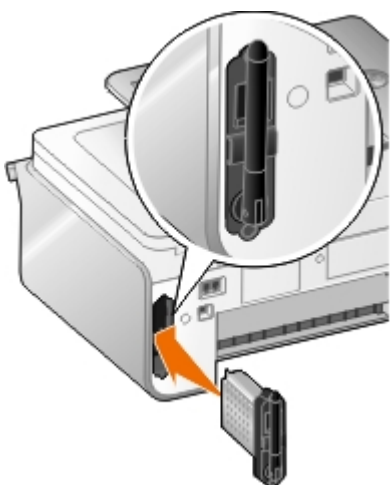

You are now ready to configure your adapter to work on your network.

 **NOTE:** Have your USB cable ready for wireless configuration or your Ethernet cable (sold separately) ready for Ethernet configuration.

Configuring the Adapter for a Wireless Connection

1. Plug the printer power cable into the wall outlet.
2. Press the **Power** button .

The wireless icon  appears in the main menu on the operator panel.

3. *If you are using your printer with a new Dell computer:* Go to [step 8](#).

If you are using your printer with an existing computer: Go to the next step.

4. Make sure your computer is on, and then insert the Drivers and Utilities CD that came with your printer. The CD launches automatically.

 **NOTE:** If you do not have your Drivers and Utilities CD, you can download the appropriate software from support.dell.com.

5. Select **Using a wireless network**, and then click **Next**.
6. Select **I Agree with the terms of this License Agreement**, and then click **Next**.
7. Read the Firewall Exception information, and then click **Next**.
8. Connect the USB cable between the port on the back of the printer and the port on the computer.
9. On the **Configure Your Wireless Printer Adapter** dialog box, select **Create or modify the printer's wireless settings**, and then click **Next**.

The Dell Wireless Setup Utility launches. Follow the instructions on your screen to complete the installation process.

 **NOTE:** The network name (SSID) and the security settings for the wireless network you want to connect to may be needed to complete this setup wizard. For more information, see the wireless network administrator or your network documentation.

For additional information on configuring your adapter, see [Configuring the Adapter Using the Wireless Setup Utility](#).

Configuring the Adapter for an Ethernet Connection

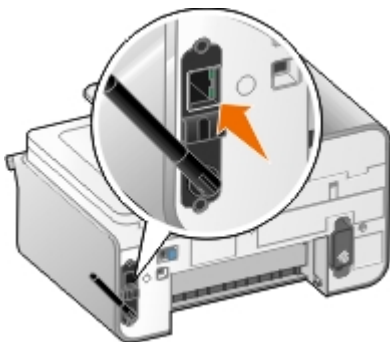

1. Connect your printer to your network using an Ethernet cable (sold separately).

2. Connect the power cable to the wall, and then press the **Power** button .

The Ethernet wired icon  appears in the main menu on the operator panel.









3. Make sure your computer is on, and then insert the Drivers and Utilities CD that came with your printer. The CD launches automatically.

 **NOTE:** If you do not have your Drivers and Utilities CD, you can download the appropriate software from support.dell.com.

4. Select **Using an Ethernet Cable**, and then click **Next**.
5. Click **I Agree to the terms of this License Agreement**, and then click **Next**.
6. Read the Firewall Exceptions information, and then click **Next**.
7. Your printer should appear in the list and it should already be selected. Click **Next** to begin the installation process.

If your printer is not in the list, you may need to manually configure your adapter's IP address to work with your network. For more information, see [Manually Configuring the IP Address](#).

Manually Configuring the IP Address

1. Print a Network Setup Page to locate your adapter IP address:
 - a. From the main menu of the printer operator panel, press the up or down **Arrow** button   to scroll to Setup, and then press the **Select** button .
 - b. Press the down **Arrow** button  to scroll to Network Setup, and then press the **Select** button .
 - c. Press the up or down **Arrow** button   to scroll to Print Network Setup Page, and then press the **Select** button .

The Network Setup Page prints.

The IP address of the adapter is labeled **Address:** under the **TCP/IP** heading.

2. From the computer, click **Enter IP Address**.

The **Configure Network Printers** dialog box opens.

3. If your printer appears in the list, click **Configure**, and then select **Configure IP Address Manually**.

If your printer is not in the list, click **Add Printer**, and then select **One New Printer**.

4. Type the IP address of the adapter into the space provided, and then click **OK**.
5. Your printer should appear in the list. Click **Close** to return to the printer selection dialog box.
6. Select your printer from the list, and then click **Next**.

Follow the instructions on the screen to complete the installation process.

For additional information on configuring your adapter to work on your network, see your network administrator or the documentation for your network.

Connecting the Printer to Another Network Computer

Using a Wireless Connection

 **NOTE:** To perform the following steps, the printer must already be connected to a computer or router using a wireless connection.



1. Make sure your printer and the additional computer are on and connected to your network.
2. From the additional computer, insert the Drivers and Utilities CD.
The CD launches automatically.
3. Select **Using a wireless network**, and then click **Next**.
4. Select **I Agree with the terms of this License Agreement**, and then click **Next**.
5. Read the Firewall Exceptions information, and then click **Next**.
6. On the **Configure Your Wireless Printer Adapter** dialog box, select **Keep the current wireless settings of the printer**, and then click **Next**.
7. Choose your printer port from the list or manually enter an IP address, and then follow the instructions on your screen. For more information, see [Manually Configuring the IP Address](#).

Using an Ethernet Connection

 **NOTE:** To perform the following steps, the printer must already be connected to your network using an Ethernet connection.

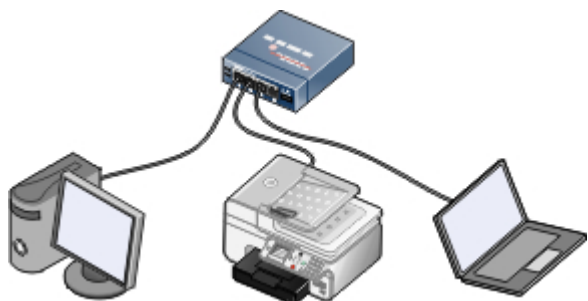

1. Make sure your printer and the additional computer are on and connected to your network.
2. From the additional computer, insert the Drivers and Utilities CD.
3. Select **Using an Ethernet cable**, and then click **Next**.
4. Select **I Agree with the terms of this License Agreement**, and then click **Next**.

5. Read the Firewall Exceptions information, and then click **Next**.
6. Choose your printer from the list or manually enter an IP address, and then follow the instructions on your screen. For more information, see [Manually Configuring the IP Address](#).

Removing and Reinstalling the Adapter

If your adapter is not functioning properly, you might need to remove the adapter and reinstall it.

NOTE: The following instructions do not apply if you purchased your printer with the network adapter pre-installed.

1. Turn off your printer, and then unplug the power cable from the wall outlet.

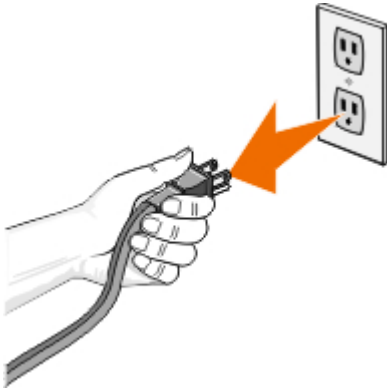

NOTICE: Failure to unplug the printer can cause damage to your printer and adapter.

2. Firmly grasp the Dell Internal Network Adapter 1150 by the side tabs, and then pull to remove.

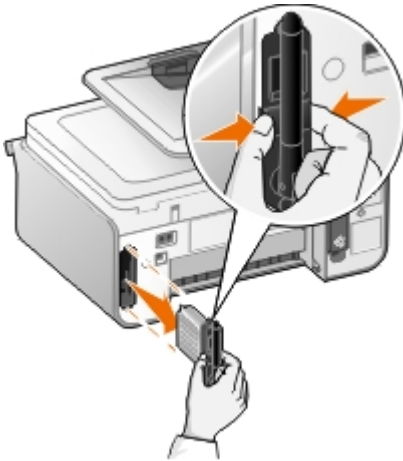

NOTICE: Your network adapter is easily damaged by static electricity. Touch a grounded metal object before you touch the adapter.

NOTICE: Do not grasp the antenna when removing the adapter. Pulling the antenna could damage the adapter.

3. Reinstall the adapter following the installation instructions. For more information, see [Installing the Adapter](#).

Configuring the Adapter Using the Wireless Setup Utility

NOTE: If you are using the Drivers and Utilities CD to set up your network connection, you do not need to launch the Wireless Setup Utility. It launches automatically when you select **Create or**

modify the printer's wireless settings from the **Configure Your Wireless Printer Adapter** dialog box. Skip the **Configuration Overview** and go to the heading that best describes your network.

Configuration Overview

Configuring the adapter using the Wireless Setup Utility involves connecting the printer in which the adapter has been installed to a computer by USB cable, and launching the Drivers and Utilities CD.

If you need to adjust the wireless adapter settings after installation, the CD is not required. Launch the Wireless Setup Utility.

In Windows Vista:

1. Click  **Programs**.
2. Click **Dell Printers**.
3. Click **Dell 968 AIO Printer**.
4. Click **Wireless Setup Utility**.

In Windows XP and Windows 2000:

1. Click **Start® Programs** or **All Programs® Dell Printers® Dell 968 AIO Printer**.
2. Click **Wireless Setup Utility**.

The Wireless Setup Utility steps you through the configuration process. The wizard can automatically detect wireless network settings or allow you to manually enter the network configuration settings.

Before configuring the adapter, make sure your printer has been set up correctly:

- The adapter has been installed correctly in the printer.
- The ink cartridges are installed correctly.
- Paper has been loaded into the printer.
- The USB cable is attached to the printer and the computer.
- The printer is turned on and ready to be installed.

Using an Available Wireless Network Configuration

1. From the **Wireless Networks Found In Your Area** screen, select the appropriate **Network Name (SSID)** from the list, and then click **Next**.
2. Select the appropriate security method, and then click **Next**. If no security was detected, go to [step 5](#).
3. Enter the appropriate security key(s) for the network, and then click **Next**.
4. On the **Apply and Verify Wireless Settings** screen, check each network attribute to make sure the settings are correct, and then click **Next** to apply the settings.

 **NOTE:** Clicking **Next** prompts the setup utility to verify wireless communication with the printer. The verification process can take up to 120 seconds.

5. Verify that the adapter can communicate over the network. For more information, see [Verifying Network Communication](#).

Entering a Different Wireless Network Configuration

1. From the **Wireless Networks Found In Your Area** screen, select **I want to enter a different configuration**, and then click **Next**.
2. *If the Network Name (SSID) you want to use is available*, select it from the list, and then click **Next**.

If the Network Name (SSID) is not available

- a. Select **I want to enter a different network name**, and then click **Next**.
- b. Enter the **Network Name (SSID)**.
- c. Select the appropriate **Channel** from the drop-down list. (**Auto** is the default.)
- d. Select your **Wireless Mode**.

- *For Infrastructure Mode*, select **Access an existing network through a wireless router (Infrastructure Mode) - Typical**, and then click **Next**.

For additional setup instructions, see [Manually Configuring the Adapter in Infrastructure Mode](#).

- *For Ad-Hoc Mode*, select **Access other computers directly without using a wireless router (Ad-Hoc Mode)**, and then click **Next**.

For additional setup instructions, see [Manually Configuring the Adapter in Ad-Hoc Mode](#).

3. Select the appropriate security method, and then click **Next**. If no security was detected, go to [step 5](#).
4. Enter the appropriate security key(s) for the network, and then click **Next**.
5. On the **Apply and Verify Wireless Settings** screen, check each network attribute to make sure the settings are correct, and then click **Next** to apply the settings.

 **NOTE:** Clicking **Next** prompts the setup utility to verify wireless communication with the printer. The verification process can take up to 120 seconds.

6. Verify that the adapter can communicate over the network. For more information, see [Verifying Network Communication](#).

Manually Configuring the Adapter in Infrastructure Mode

To set up the adapter in Infrastructure Mode, the setup steps vary based on the security settings you select.

- *If you don't want any security*

1. From the **Wireless Security Settings** screen, select **No Security**, and then click **Next**.
2. On the **Apply and Verify Wireless Settings** screen, check each network attribute to make sure the settings are correct, and then click **Next** to apply the settings.

3. Verify that the adapter can communicate over the network. For more information, see [Verifying Network Communication](#).
- *If you want to use Wired Equivalent Privacy (WEP) security*
 1. From the **Wireless Security Settings** screen, select **Wired Equivalent Privacy (WEP)**, and then click **Next**.

The **WEP Security Information** screen opens.
 2. Enter the appropriate **Network Key**, and then click **Next**.
 3. On the **Apply and Verify Wireless Settings** screen, check each network attribute to make sure the settings are correct, and then click **Next** to apply the settings.
 4. Verify that the adapter can communicate over the network. For more information, see [Verifying Network Communication](#).
 - *If you want to use Wi-Fi Protected Access (WPA) security*
 1. From the **Wireless Security Settings** screen, select **Wi-Fi Protected Access (WPA)** and then click **Next**.

The **WPA Security Information** screen opens.
 2. Enter the appropriate **WPA Network Key**, and then click **Next**.
 3. On the **Apply and Verify Wireless Settings** screen, check each network attribute to make sure the settings are correct, and then click **Next** to apply the settings.
 4. Verify that the adapter can communicate over the network. For more information, see [Verifying Network Communication](#).
 - *If you only want to connect to access points that support WPA2 security*
 1. From the **Wireless Security Settings** screen, select **Wi-Fi Protected Access (WPA)**, and then click **Advanced WPA Settings**.

The **Advanced WPA Options** dialog box opens.
 2. Select the **Use WPA2 authentication only** check box, and then click **OK**.

You are returned to the **Wireless Security Settings** screen.
 3. Click **Next**.
 4. Enter the appropriate **WPA Network Key**, and then click **Next**.
 5. On the **Apply and Verify Wireless Settings** screen, check each network attribute to make sure the settings are correct, and then click **Next** to apply the settings.
 6. Verify that the adapter can communicate over the network. For more information, see [Verifying Network Communication](#).

Manually Configuring the Adapter in Ad-Hoc Mode

To set up the adapter in Ad-Hoc Mode, the setup steps vary based on the security settings you select. The security options are more limited in Ad-Hoc Mode than they are in Infrastructure Mode.

- *If you don't want any security*

1. From the **Wireless Security Settings** screen, select **No Security**, and then click **Next**.
 2. On the **Apply and Verify Wireless Settings** screen, check each network attribute to make sure the settings are correct, and then click **Next** to apply the settings.
 3. Verify that the adapter can communicate over the network. For more information, see [Verifying Network Communication](#).
- *If you want to use Wired Equivalent Privacy (WEP) security*
 1. From the **Wireless Security Settings** screen, select **Wired Equivalent Privacy (WEP)**, and then click **Next**.
 2. Enter the appropriate **Network Key**.
 3. If you have additional network keys, select the **My network requires more than one network key** check box, and then enter the additional network keys.
 4. Click **Next**.
 5. On the **Apply and Verify Wireless Settings** screen, check each network attribute to make sure the settings are correct, and then click **Next** to apply the settings.
 6. Verify that the adapter can communicate over the network. For more information, see [Verifying Network Communication](#).

Verifying Network Communication

You should verify that your adapter can communicate over the network before completing installation of the printer software.

- *If the adapter was successfully configured and is available on the network, remove the USB cable, and click **Next** to continue with printer software installation.*
- *If the adapter was not able to join the wireless network, try one of the following suggestions:*
 - Click **View Settings** to verify the settings are correct.
 - Select **I want to change the settings I entered**, and then click **Next**.
Follow the instructions on your screen to update the wireless settings.
 - Select **I have moved my wireless printer closer to the wireless router. I would like to try connecting again**, and then click **Next**.

Loading Paper and Originals

- [Loading Paper Into Trays](#)
 - [Understanding the Automatic Paper Type Sensor](#)
 - [Loading Original Documents](#)
-

Loading Paper Into Trays

Loading Paper

1. Fan the paper.



2. Remove the paper tray. Push the lever in, and then extend the tray until it is long enough to accommodate the length of the paper.

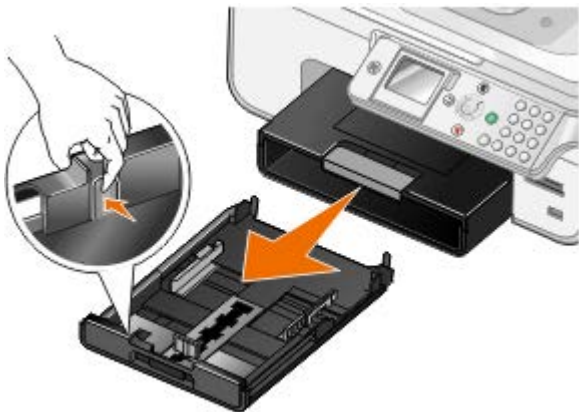

3. Load paper in the paper tray, and then adjust the paper guides.

 **NOTE:** You can only load letter size, legal size, or A4 paper in the optional paper tray.

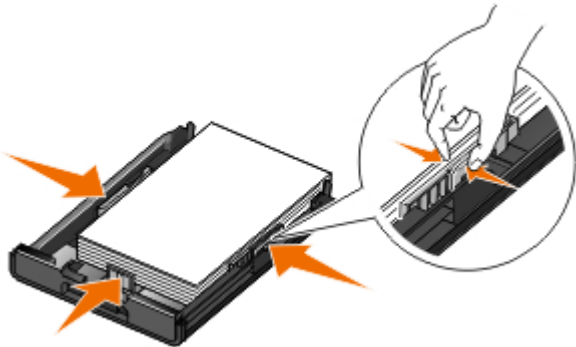

4. Replace the paper tray.



5. Extend the paper support on the paper tray, and then lift the paper stop.



 NOTE: The paper exit tray can hold up to 100 sheets of paper.

Print Media Guidelines

Load up to:	Make sure:
150 sheets of plain paper	<ul style="list-style-type: none"> The paper guides rest against the edges of the paper. You load the paper with the print side facing down and the top going into the printer first. You select Automatic, Draft, Normal, or Photo print quality. Do not select Draft if you have a Photo cartridge installed.
10 envelopes in the paper tray 1 envelope into the small media feeder 	<ul style="list-style-type: none"> The print side of the envelope faces down. You can also insert envelopes into the small media feeder one at a time. You print the envelopes with Landscape orientation with the return address on the left. <p>NOTE: If you are mailing within Japan, the envelope can be printed in Portrait orientation with the stamp in the lower right corner or in Landscape orientation with the stamp in the lower left corner. If you are mailing internationally, print Landscape orientation with the stamp in the upper left corner.</p> <ul style="list-style-type: none"> You select the correct envelope size. Select the next biggest size if the exact envelope size is not listed, and set the left and right margins so your envelope text is correctly positioned.
20 sheets of banner paper	<ul style="list-style-type: none"> You remove all paper from the paper input tray before inserting banner paper. You use banner paper designed for inkjet printers. You select A4 Banner or Letter Banner paper size.

NOTE: For more information on how to load banner paper, see [Loading Banner Paper](#).

25 greeting cards, index cards, postcards, or photo cards in the paper tray

1 greeting card, index card, postcard, or photo card into the small media feeder

30 sheets of Hagaki or Hagaki photo cards in the paper tray



- The print side of the cards faces down.
- You can also insert cards into the small media feeder one at a time.
- You select **Automatic**, **Normal** or **Photo** print quality.

50 sheets of glossy/photo or heavyweight matte paper

- The print side of the paper faces down.
- The paper guides rest against the edges of the paper.
- You select **Automatic**, **Normal** or **Photo** print quality.

10 mm stack of iron-on transfers

- You follow the loading instructions on the iron-on transfer packaging.
- The print side of the transfer faces down.
- The paper guides rest against the edges of the transfer.
- You select **Automatic**, **Normal** or **Photo** print quality.

50 sheets of transparencies

- The rough side of the transparencies faces down.
- The paper guides rest against the edges of the transparencies.
- You select **Automatic**, **Draft**, **Normal** or **Photo** print quality.

25 sheets of labels

- The print side of the labels faces down.
- The top of the labels feeds into the printer first.
- The paper guides rest against the edges of the paper.

150 sheets of letterhead paper

- The print side of the letterhead faces down.
- The top of the letterhead feeds into the printer first.
- The paper guides rest against the edges of the paper.

150 sheets of custom size paper

- The paper fits within these dimensions:
Width: 3.0 – 8.5 inches (76 – 216 mm)

Length: 5.0 – 17.0 inches (127 – 432 mm)

- The print side of the paper faces down.
- The paper guides rest against the edges of the paper.

Loading Banner Paper

1. Remove the paper tray.
2. Remove any paper from the tray.
3. Push the lever in, and then extend the tray until it is long enough to accommodate legal size paper.

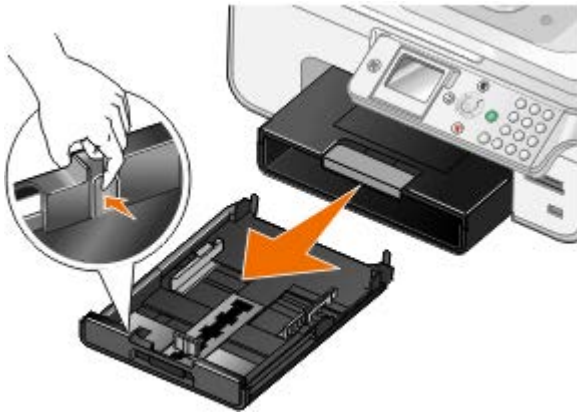

4. Replace the paper tray.
5. Tear off only the number of banner pages needed for the banner.
6. Set the stack of paper on a flat surface in front of the printer.
7. Slide the first sheet of the banner over the handle and all the way into the back of the paper tray.

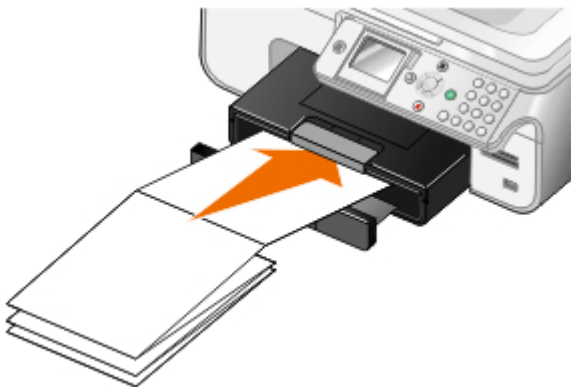

Understanding Tray Linking

If you purchased an optional paper tray, you can set the trays to link to each other. Tray linking enables the automatic linking feature for trays when you load the same size and type of paper in the standard and optional paper trays. The printer automatically links the trays; when one tray is empty, paper feeds from the next linked tray.

For example, if you have the same size and type of paper in Tray 1 (standard paper tray) and Tray 2

(optional tray), the printer selects print media from Tray 1 until it becomes empty, and then the printer automatically feeds print paper from Tray 2.

In addition, you can load a different size of paper for each tray so that the printer picks the paper that matches the size of the fax you received. For example, if letter size is loaded in Tray 1 and legal size is loaded in Tray 2, if you receive a legal size fax, the printer picks from Tray 2.

 **NOTE:** You can only load letter size, legal size, or A4 paper in the optional paper tray.

You can enable Tray Linking after you have installed the optional paper tray. You can also turn this option on and off, as needed.

Enabling Tray Linking for Print Jobs Using the Computer

1. Turn on your computer and printer, and make sure they are connected.
2. Load paper of the same type and size in both paper trays.
3. With your document open, click **File® Print**.

The **Print** dialog box opens.

4. Click **Preferences, Properties, Options, or Setup** (depending on the program or operating system).









The **Printing Preferences** dialog box opens.

5. On the **Print Setup** tab, select **Automatic** from the **Paper Source** drop-down list.
6. On the **Print Setup** and **Advanced** tabs, make any necessary changes for your document.
7. When you finish customizing your settings, click **OK**.





The **Printing Preferences** dialog box closes.

8. Click **OK** or **Print**.





Enabling Tray Linking for Print Jobs Using the Operator Panel

1. From the main menu, use the up or down **Arrow** button   to scroll to Setup, and then press the **Select** button .
2. From Paper Handling, press the **Select** button .
3. Press the up or down **Arrow** button   to scroll to Tray Linking, and then press the left or right **Arrow** button   to scroll to Auto.
4. Press the **Back** button .













Enabling Tray Linking For Copying Jobs

1. Load paper of the same type and size in both paper trays.
2. From the **Main menu**, press the up or down **Arrow** button   to scroll to Setup, and then press the **Select** button .
3. From the **Setup** menu, press the up or down **Arrow** button   to scroll to Change Copy Default

Settings, and then press the **Select** button .

- From the **Copy Default Settings** menu, press the down **Arrow** button  to scroll to Paper Handling, and then press the **Select** button .
- From the **Paper Handling** menu, specify the size and type of paper loaded in both paper trays.
- Press the up or down **Arrow** button  to scroll to Tray Linking, and then press the left or right **Arrow** button  to select Auto.
- Press the **Back** button  to save the settings and return to the previous menu.

Enabling Tray Linking to Print Received Faxes

- Load paper of the same type but of different sizes in both trays.
- From the **Main menu**, press the up or down **Arrow** button  to scroll to Setup, and then press the **Select** button .
- From the **Setup** menu, press the up or down **Arrow** button  to scroll to Change Fax Default Settings, and then press the **Select** button .
- From the **Fax Setup** menu, press the up or down **Arrow** button  to scroll to Fax Printing, and then press the **Select** button .
- From the **Fax Printing** menu, press the down **Arrow** button  to scroll to Paper Handling, and then press the **Select** button .
- From the **Paper Handling** menu, specify the size and type of paper loaded in both paper trays.
- Press the up or down **Arrow** button  to scroll to Tray Linking, and then press the left or right **Arrow** button  to select Auto.
- Press the up or down **Arrow** button  to scroll to Fax Source, and then press the left or right **Arrow** button  to select the paper source.
- Press the **Back** button  to save the settings and return to the previous menu.

 **NOTE:** If you load media of the same type and size in both trays, the printer picks from the next tray once the paper source you specified for faxing is empty.

Understanding the Automatic Paper Type Sensor

Your printer has an automatic paper type sensor that detects the following paper types:

- Plain/heavyweight matte
- Transparency
- Photo/glossy

If you load one of these paper types, the printer detects the paper type and automatically adjusts the Quality/Speed settings.

Paper type	Quality/Speed settings	
	Black and Color Cartridges Installed	Photo and Color Cartridges Installed
Plain/heavyweight matte	Normal	Photo
Transparency	Normal	Photo
Photo/glossy	Photo	Photo

 **NOTE:** Your printer cannot detect paper size.

To choose paper size:

1. With your document open, click **File® Print**.

The **Print** dialog box opens.

2. Click **Preferences, Properties, Options, or Setup** (depending on the program or operating system).

The **Printing Preferences** dialog box opens.

3. On the **Print Setup** tab, select the paper size.

4. Click **OK**.

The automatic paper type sensor is always on, unless you turn it off. To turn off the automatic paper type sensor for a specific print job:

1. With your document open, click **File® Print**.

The **Print** dialog box opens.

2. Click **Preferences, Properties, Options, or Setup** (depending on the program or operating system).

The **Printing Preferences** dialog box opens.

3. On the **Print Setup** tab, select the paper type.

4. Click **OK**.

To turn off the automatic paper type sensor for all print jobs:

1. *In Windows Vista™:*

- a. Click  **Control Panel**.
- b. Click **Hardware and Sound**.
- c. Click **Printers**.

*In Windows® XP, click **Start® Control Panel® Printers and Other Hardware® Printers and Faxes**.*

*In Windows 2000, click **Start® Settings® Printers**.*

2. Right-click the printer icon.
3. Click **Printing Preferences**.

4. On the **Print Setup** tab, select the paper type.
5. Click **OK**.

Loading Original Documents

Into the ADF

You can load up to 50 sheets of an original document into the ADF for scanning, copying, and faxing. The ADF is recommended for loading multiple-page documents.

1. Load an original document text side up into the ADF.



NOTE: Do not load postcards, photos, small items, or thin media (such as magazine clippings) into the ADF. Place these items on the scanner glass.

2. Adjust the paper guide on the ADF against the edges of the paper.

ADF Paper Capacity

Load up to	Make sure
50 sheets of letter size paper	<ul style="list-style-type: none"> • The document is loaded text side up. • The paper guide rests against the edge of the paper.
50 sheets of legal size paper	<ul style="list-style-type: none"> • The document is loaded text side up. • The paper guide rests against the edge of the paper.
50 sheets of A4 size paper	<ul style="list-style-type: none"> • The document is loaded text side up. • The paper guide rests against the edge of the paper.
50 sheets of two-, three-, or four-hole pre-punched media	<ul style="list-style-type: none"> • The paper fits within these dimensions: Width: 8.27 – 8.5 inches (210.0 – 215.9 mm) Length: 11.0 – 14.0 inches (279.4 – 355.6 mm) • The document is loaded text side up. • The paper guide rests against the edge of the paper.
50 sheets of edge-reinforced three-hole copier media	<ul style="list-style-type: none"> • The paper fits within these dimensions: Width: 8.27 – 8.5 inches (210.0 – 215.9 mm) Length: 11.0 – 14.0 inches (279.4 – 355.6 mm) • The document is loaded text side up. • The paper guide rests against the edge of the paper.

50 sheets of preprinted forms and letterhead media	<ul style="list-style-type: none">• The paper fits within these dimensions: Width: 8.27 – 8.5 inches (210.0 – 215.9 mm) Length: 11.0 – 14.0 inches (279.4 – 355.6 mm)• The document is loaded text side up.• The paper guide rests against the edge of the paper.• You allow the preprinted media to dry thoroughly before use in the ADF.• You do <i>not</i> use media printed with metallic ink particles in the ADF.• You avoid embossed designs.
50 sheets of custom size paper	<ul style="list-style-type: none">• The paper fits within these dimensions: Width: 8.27 – 8.5 inches (210.0 – 215.9 mm) Length: 11.0 – 14.0 inches (279.4 – 355.6 mm)• The document is loaded text side up.• The paper guide rests against the edge of the paper.

On the Scanner Glass

1. Open the top cover.



2. Place the document face down on the scanner glass.

 **NOTE:** Make sure the upper left corner of the front of the item aligns with the arrow on the printer.



3. Close the top cover.



Maintenance

- [Replacing Ink Cartridges](#)
- [Aligning Ink Cartridges](#)
- [Cleaning the Ink Cartridge Nozzles](#)
- [Cleaning the Exterior of the Printer](#)
- [Restoring Factory Default Settings](#)
- [Restoring Language to Factory Default](#)

⚠ CAUTION: Before performing any of the procedures listed in this section, read and follow the safety information in your Owner's Manual.

Dell ink cartridges are available only through Dell. You can order more ink online at www.dell.com/supplies or by phone.

Dell recommends Dell ink cartridges for your printer. Dell does not provide warranty coverage for problems caused by using accessories, parts, or components not supplied by Dell.

Replacing Ink Cartridges

1. Turn on your printer.
2. Lift the scanner base unit.



The ink cartridge carrier moves and stops at the loading position unless the printer is busy.

3. Press down on the ink cartridge lever to raise each ink cartridge lid.

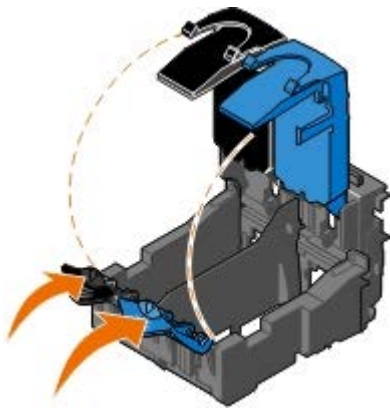

4. Remove the old ink cartridges.

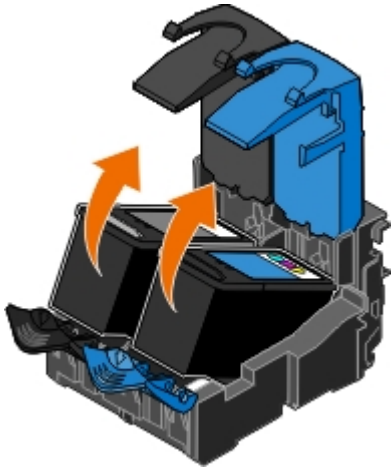

5. Store the cartridges in an air-tight container, such as the storage unit you received with your photo cartridge, or dispose of them properly.

6. If you are installing new ink cartridges, remove the sticker and transparent tape from the back and bottom of each ink cartridge.

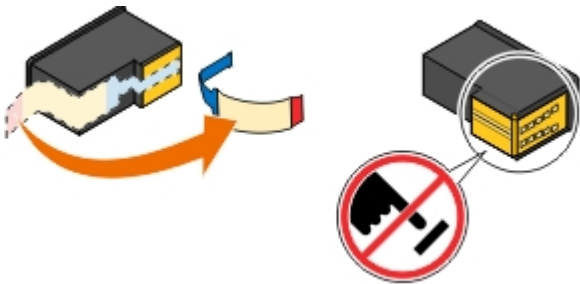

⚠ **NOTICE:** Do not touch the gold contact area on the side or the metal nozzles on the bottom of the ink cartridges.

7. Insert the new ink cartridges. Make sure the black or photo ink cartridge is secure in the left ink cartridge carrier, and the color ink cartridge is secure in the right ink cartridge carrier.

📌 **NOTE:** For normal printing, use a black cartridge and a color cartridge. For photo printing, replace the black cartridge with a photo cartridge.



8. *Snap* each lid closed.

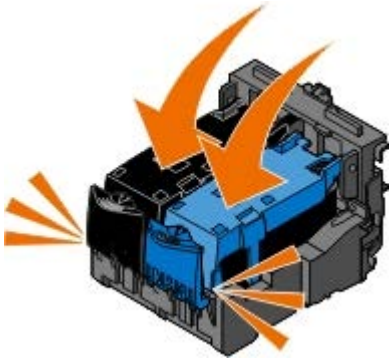



9. Lower the scanner base unit until it is completely closed.



Aligning Ink Cartridges

Your printer automatically prompts you to align the ink cartridges when they are installed or replaced. You may also need to align ink cartridges when characters are not properly formed or are not aligned at the left margin, or when vertical or straight lines appear wavy.

To align the ink cartridges from the operator panel:

1. Load plain paper. For more information, see [Loading Paper](#).
2. Press the down **Arrow** button  to scroll to Maintenance.
3. Press the **Select** button .
4. Press the up or down **Arrow** button  to scroll to Align Cartridges.

5. Press the **Select** button .

The alignment page begins printing. The ink cartridges align when the page prints.

To align the ink cartridges from the printer software:

1. Load plain paper.
2. *In Windows Vista™:*
 - a. Click  **Control Panel**.
 - b. Click **Hardware and Sound**.
 - c. Click **Printers**.

*In Windows® XP, click **Start® Control Panel® Printers and Other Hardware® Printers and Faxes**.*

*In Windows 2000, click **Start® Settings® Printers**.*

3. Right-click the **Dell 968 AIO Printer** icon.
4. Click **Printing Preferences**.

The **Printing Preferences** dialog box opens.

5. Click the **Maintenance** tab.
6. Click **Align Ink Cartridges**.
7. Click **Print**.





The ink cartridges align when the page prints.

Cleaning the Ink Cartridge Nozzles

You may need to clean the nozzles when:

- White lines appear in graphics or solid black areas.
- Print appears smudged or too dark.
- Colors fade, do not print, or do not print correctly.
- Vertical lines appear jagged, or edges appear rough.

To clean the nozzles from the operator panel:

1. Load plain paper. For more information, see [Loading Paper](#).
2. Press the down **Arrow** button  to scroll to Maintenance.
3. Press the **Select** button .
4. Press the up or down **Arrow** button  to scroll to Clean Cartridges.
5. Press the **Select** button .

The cleaning page begins printing.

To clean the nozzles from the printer software:

1. Load plain paper.
2. *In Windows Vista:*
 - a. Click  **Control Panel**.
 - b. Click **Hardware and Sound**.
 - c. Click **Printers**.

In Windows XP, click **Start**® **Control Panel**® **Printers and Other Hardware**® **Printers and Faxes**.

In Windows 2000, click **Start**® **Settings**® **Printers**.

3. Right-click the **Dell 968 AIO Printer** icon.
4. Click **Printing Preferences**.

The **Printing Preferences** dialog box opens.

5. Click the **Maintenance** tab.
6. Click **Clean Ink Cartridges**.

The cleaning page prints.

7. If the print quality has not improved, click **Clean Again**.
8. Print your document again to verify the improved print quality.

If you are still not satisfied with the print quality, wipe the nozzles with a clean, dry cloth, and then print your document again.

Cleaning the Exterior of the Printer

1. Make sure that the printer is turned off and unplugged from the wall outlet.

 **CAUTION:** To avoid the risk of electric shock, unplug the power cord from the wall outlet and disconnect all cables to the printer before proceeding.

2. Remove paper from the paper support and paper exit tray.
3. Dampen a clean, lint-free cloth with water.

 **NOTICE:** Do not use household cleaners or detergents, as they may damage the finish of the printer.





4. Wipe only the outside of the printer, making sure to remove any ink residue that has accumulated on the paper exit tray.





 **NOTICE:** Using a damp cloth to clean the interior may cause damage to your printer. Damage to the printer caused by not following the correct instructions for cleaning will not be covered under warranty.

5. Make sure the paper support and paper exit tray are dry before beginning a new print job.
-

Restoring Factory Default Settings

Menu settings marked with an asterisk (*) indicate the active settings. You can restore the original printer settings, often referred to as the *factory default settings*.

1. Make sure the printer is on.
2. Press the down **Arrow** button  to scroll to Maintenance, and then press the **Select** button .
3. Press the down **Arrow** button  to scroll to Reset Defaults, and then press the **Select** button .
4. With Yes highlighted, press the **Select** button .









 **NOTE:** If a network adapter is attached to the printer, Also reset all Network Settings to factory defaults? appears. Press the left or right **Arrow** button   to select Yes or No, and then press the **Select** button .

 **NOTE:** Some settings such as phone lists, time, date, and country are not changed.

Restoring Language to Factory Default

You can restore the language on your display to factory default without using the printer menus.

 **NOTE:** Using this key sequence will also restore all other selected settings to factory default.

1. Turn your printer off.
2. Press and hold the **Start** button  and the **Cancel** button .
3. While holding the **Start** button  and the **Cancel** button , press and release the **Power** button .
4. Continue holding the two buttons until the **Initial Setup** screen appears.
5. Press the left or right **Arrow** button   to select your language and country. Press the **Select** button  to save each selection.
6. Use the keypad to enter the time, date, your fax number, and your fax name. Press the **Select** button  to save each selection.

The printer aligns the ink cartridges after your final selection.

Printing

- [Printing Documents](#)
 - [Printing Photos](#)
 - [Printing Envelopes](#)
 - [Printing From a Bluetooth®-Enabled Device](#)
 - [Printing Photos From a PictBridge-Enabled Camera](#)
 - [Printing More Than One Page on a Sheet of Paper](#)
 - [Printing an Image as a Multi-Page Poster](#)
 - [Printing a Banner](#)
 - [Printing Collated Copies of Your Document](#)
 - [Printing a Booklet](#)
 - [Assembling a Booklet](#)
 - [Duplexing a Print Job \(Two-Sided Printing\)](#)
 - [Canceling a Print Job](#)
 - [Changing Printing Preferences Defaults](#)
-

Printing Documents

1. Turn on your computer and printer, and make sure they are connected.
2. Load the paper. For more information, see [Loading Paper](#).
3. With your document open, click **File® Print**.

The **Print** dialog box opens.

4. Click **Preferences**, **Properties**, **Options**, or **Setup** (depending on the program or operating system).

The **Printing Preferences** dialog box opens.

5. On the **Print Setup** and **Advanced** tabs, make any necessary changes for your document.
6. After customizing your settings, click **OK**.

The **Printing Preferences** dialog box closes.

7. Click **OK** or **Print**.
-

Printing Photos

 **NOTE:** Dell recommends you use a color cartridge and a photo cartridge for printing photos.

1. Turn on your computer and printer, and make sure they are connected.
2. Load paper with the print side facing down.

 **NOTE:** Photo/glossy paper is recommended for printing photos.

3. With your document open, click **File® Print**.

The **Print** dialog box opens.

4. Click **Preferences**, **Properties**, **Options**, or **Setup** (depending on the program or operating system).

The **Printing Preferences** dialog box opens.

5. On the **Print Setup** tab, select **Photo**, and then select the dpi settings for the photo from the drop-down menu.

 **NOTE:** To print borderless photos, click the **Borderless** check box on the **Print Setup** tab, and then select the borderless paper size from the drop-down menu on the **Advanced** tab. Borderless printing is only performed if you are using photo/glossy paper.

6. On the **Print Setup** and **Advanced** tabs, make any necessary changes for your document.
7. After customizing your settings, click **OK**.

The **Printing Preferences** dialog box closes.

8. Click **OK** or **Print**.
9. Remove each photo after it exits the printer to prevent your photos from sticking together or smudging.

 **NOTE:** Before placing your prints in a nonadhesive photo album or frame, allow sufficient time for the prints to dry thoroughly (12 to 24 hours, depending on ambient conditions). This maximizes the life of your prints.

Printing Envelopes

1. Turn on your computer and printer, and make sure they are connected.
2. Load the envelope with the print side facing down.



3. With your document open, click **File® Print**.

The **Print** dialog box opens.

4. Click **Preferences**, **Properties**, **Options**, or **Setup** (depending on the program or operating system).

The **Printing Preferences** dialog box opens.

5. On the **Print Setup** tab, select **Envelope** orientation, and then choose the size of the envelope from the **Paper size: drop-down** menu.

 **NOTE:** If you are mailing within Japan, the envelope can be printed in portrait orientation with the stamp in the lower right corner or in landscape orientation with the stamp in the lower left corner. If you are mailing internationally, print landscape orientation with the stamp in the upper left corner.

6. On the **Print Setup** and **Advanced** tabs, make any necessary changes for your document.
7. After customizing your settings, click **OK**.

The **Printing Preferences** dialog box closes.

8. Click **OK** or **Print**.

Printing From a Bluetooth[®]-Enabled Device

- This printer is compliant with Bluetooth Specification 1.2. It supports both Object Push Profile (OPP) and PCL3 printing. Check with your Bluetooth-enabled device manufacturers (cellular phone or PDA) to determine their hardware compatibility and interoperability. It is recommended that you use the latest firmware on your Bluetooth-enabled device.
- To print Microsoft documents from your Windows[®] Mobile/Pocket PC PDA, additional third-party software and drivers may be required. For more information about the required software and drivers, please check the documentation of your PDA.
- Before you call Dell customer support, see the section for information on setting up a connection with a Bluetooth-enabled device. You can also visit the Dell Support website at support.dell.com. This website contains the latest documentation. Ensure that you read the documentation that came with your Bluetooth device for setup instructions.

Setting up a Connection Between Your Printer and a Bluetooth-Enabled Device

 NOTE: The printer does not support printing files from your computer using a Bluetooth connection.

You need to set up a connection between a Bluetooth-enabled device and your printer if you are sending a print job from the Bluetooth device for the first time. You must repeat the setup if:

- You reset the printer to its factory default settings. For more information, see [Restoring Factory Default Settings](#).
- You changed the Bluetooth security level or the Bluetooth pass key. For more information, see [Setting the Bluetooth Security Level](#).
- The Bluetooth-enabled device you are using requires users to set up a Bluetooth connection on every print job. Refer to the instructions included with the device for Bluetooth printing information.
- You cleared the contents of the Bluetooth device list. For more information, see [Bluetooth Mode](#).
- The name of the Bluetooth device you are using is automatically deleted from the Bluetooth device list.

When the Bluetooth security level is set to High, the printer saves a list of up to eight Bluetooth devices that have previously set up a connection with the printer. If there are already eight devices on the list, and then you need to set up a connection for another Bluetooth device, the first device is automatically deleted from the list so that the new device can be stored. You need to repeat the setup of the deleted device to be able to send a print job to the printer.

 NOTE: You need to set up a connection for each Bluetooth device that you use to send a print job to the printer.









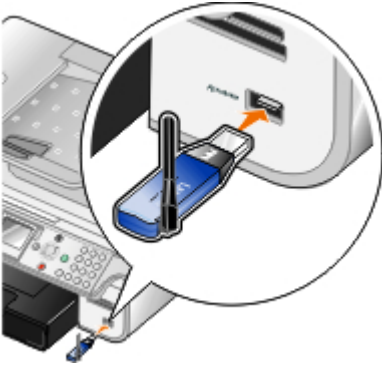





To set up a connection between the external Bluetooth-enabled device and the printer:

1. Activate Bluetooth on the device.

Refer to the device documentation for information.

2. Turn on the printer.
3. Insert a USB Bluetooth adapter (sold separately) into the PictBridge port.









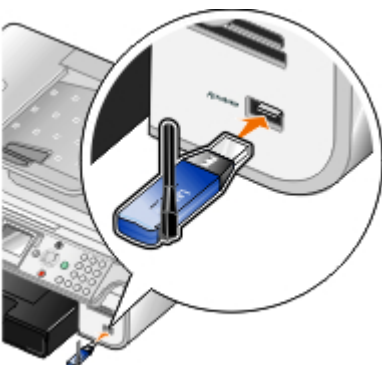







4. Press the up or down **Arrow** button   to scroll to Setup, and then press the **Select** button .
5. Press the up or down **Arrow** button   to scroll to Change Bluetooth Default Settings, and then press the **Select** button .
6. From Bluetooth Enabled, press the left or right **Arrow** button   to scroll to On.
7. From Discovery Mode, press the left or right **Arrow** button   to scroll to On.
8. From Security, press the left or right **Arrow** button   to choose a security level.
 **NOTE:** If the security level is set to High, you need to specify a pass key for the USB Bluetooth adapter. Any external Bluetooth-enabled device needs to enter this pass key to send a print job to your printer.
9. Press the **Back** button  to save your settings and go back to the previous menu.

Printing from a Bluetooth-Enabled Device

1. Make sure the external Bluetooth-enabled device is set up to print to the printer. Refer to the device documentation for information.
 **NOTE:** Some devices display the USB Bluetooth adapter's name or address. Access the **Bluetooth Default Settings** menu to view the name and address of your USB Bluetooth adapter.
2. Insert a USB Bluetooth adapter (sold separately) into the PictBridge port.

















-  **NOTE:** Do not remove the Bluetooth-enabled device or touch the printer near the area of the memory cards or Bluetooth-enabled device while actively printing from Bluetooth. Data corruption can occur.

3. Set **Bluetooth Enabled** and **Discovery Mode** to On.
 - a. From the main menu, press the up or down **Arrow** button   to scroll to Setup, and then press the **Select** button .
 - b. Press the up or down **Arrow** button   to scroll to Change Bluetooth Default Settings, and then press the **Select** button .
 - c. From Bluetooth Enabled, press the left or right **Arrow** button   to scroll to On.
 - d. Press the up or down **Arrow** button   to scroll to Discovery Mode, and then press the left or right **Arrow** button   to scroll to **On**.
 - e. Press the **Back** button .
4. From your external Bluetooth-enabled device, send the print job to the printer. Refer to the device documentation for more information.

 **NOTE:** If the security level is set to High, you are required to enter the pass key from the external Bluetooth-enabled device. The pass key can be changed or viewed in the **Bluetooth Default Settings** menu. For more information, see [Bluetooth Mode](#).

Setting the Bluetooth Security Level

1. Turn on the printer.
2. Press the up or down **Arrow** button   to scroll to Setup, and then press the **Select** button .
3. Press the up or down **Arrow** button   to scroll to Change Bluetooth Default Settings, and then press the **Select** button .
4. From Bluetooth Enabled, press the left or right **Arrow** button   to scroll to On.
5. Press the up or down **Arrow** button   to scroll to Security Level, and then press the left or right **Arrow** button   to choose a security level.
 - Choose Low to allow Bluetooth devices to connect and send print jobs to your printer without requiring users to enter a pass key.
 - Choose High to require users to enter a four-digit numeric pass key on the Bluetooth device before connecting and sending print jobs to the printer.
6. If you set the security level to High, press the down **Arrow** button  to scroll to Pass Key.

The default pass key is set to 0000.
7. Press the left **Arrow** button  repeatedly to erase the default pass key, and then use the keypad to enter a new four-digit pass key.
8. Press the **Back** button  to save your changes.

Printing Photos From a PictBridge-Enabled Camera

Your printer supports printing from a PictBridge-enabled camera.

1. Turn on your printer.
2. Insert one end of the USB cable into the camera.
3. Insert the other end of the USB cable into the PictBridge port on the front of the printer.

See the instructions included with your camera for selection of the appropriate camera USB settings and PictBridge connection and usage information.

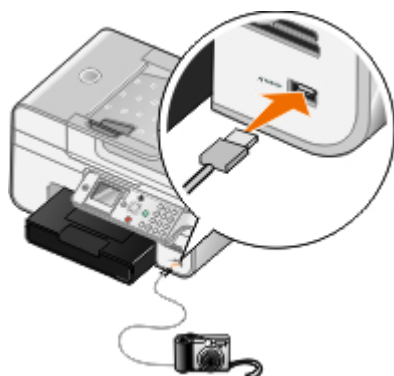

NOTE: When your printer is not connected to a computer, and a PictBridge camera is connected to your printer, some of the functions of your printer operator panel buttons may be unavailable. These functions become available after you disconnect the PictBridge camera from your printer.

4. Turn on your digital camera.

The printer automatically enters **PictBridge** mode.

5. See the instructions included with your camera to begin printing photos.

NOTICE: Do not remove the PictBridge-enabled device or touch the printer near the area of the memory card or PictBridge-enabled device while actively printing from PictBridge. Data corruption can occur.

NOTE: If your digital camera has computer and printer (PTP) USB mode selections, use the printer (PTP) USB mode selection for PictBridge printing. For more information, see the documentation included with your camera.

Printing More Than One Page on a Sheet of Paper

1. Turn on your computer and printer, and make sure they are connected.
2. Load the paper. For more information, see [Loading Paper](#).
3. With your document open, click **File® Print**.
4. Click **Preferences, Properties, Options, or Setup** (depending on the program or operating system).

The **Printing Preferences** dialog box opens.

5. On the **Advanced** tab, select **N-up** from the **Layout** drop-down list.
6. From the **Pages per sheet** drop-down list, select how many pages you want to be printed on one sheet.

7. Select the **Print Page Borders** check box if you want borders between pages.
8. On the **Print Setup** tab and **Advanced** tab, make any additional changes for your document.
9. Select the number of pages to print on each page.
10. After customizing your settings, click **OK**.

The **Printing Preferences** dialog box closes.

11. Click **OK** or **Print**.
-

Printing an Image as a Multi-Page Poster

1. Turn on your computer and printer, and make sure they are connected.
2. Load the paper. For more information, see [Loading Paper](#).
3. With your document open, click **File® Print**.
4. Click **Preferences**, **Properties**, **Options**, or **Setup** (depending on the program or operating system).

The **Printing Preferences** dialog box opens.

5. On the **Advanced** tab, select **Poster** from the **Layout** drop-down list.
6. Select the size of the poster.
7. On the **Print Setup** tab and **Advanced** tab, make any additional changes for your document.
8. After customizing your settings, click **OK**.

The **Printing Preferences** dialog box closes.

9. Click **OK** or **Print**.
-

Printing a Banner

1. Turn on your computer and printer, and make sure they are connected.
2. Load the paper. For more information, see [Loading Paper](#).
3. With your document open, click **File® Print**.
4. Click **Preferences**, **Properties**, **Options**, or **Setup** (depending on the program or operating system).

The **Printing Preferences** dialog box opens.

5. On the **Advanced** tab, select **Banner** from the **Layout** drop-down list, and then select **Letter Banner** or **A4 Banner** from the **Banner Paper Size** drop-down list.
6. On the **Print Setup** and **Advanced** tabs, make any additional changes for your document.
7. After customizing your settings, click **OK**.

The **Printing Preferences** dialog box closes.

8. Click **OK** or **Print**.

 **NOTE:** Once the printer begins printing, wait until you can see the leading edge of the banner exiting the printer, and then carefully unfold the paper down to the floor in front of the printer.

Printing Collated Copies of Your Document

1. Turn on your computer and printer, and make sure they are connected.
2. Load the paper. For more information, see [Loading Paper](#).
3. With your document open, click **File® Print**.

The **Print** dialog box opens.

4. Click **Preferences**, **Properties**, **Options**, or **Setup** (depending on the program or operating system).

The **Printing Preferences** dialog box opens.

5. On the **Print Setup** tab, specify the number of copies to print.

 **NOTE:** You must specify more than one copy for the **Collate copies** check box to become active.

6. Select the **Collate copies** check box.
7. On the **Print Setup** and **Advanced** tabs, make any additional changes for your document.
8. After customizing your settings, click **OK**.

The **Printing Preferences** dialog box closes.

9. Click **OK** or **Print**.
-

Printing a Booklet

Before you change any Print Properties settings, you must select the correct paper size from the program. You can print booklets using these paper sizes:

- Letter
- A4

1. Load the paper. For more information, see [Loading Paper](#).
2. With your document open, click **File® Print**.
3. From the Print dialog box, click **Properties**, **Preferences**, **Options**, or **Setup** (depending on the program or operating system).
4. Click the **Advanced** tab.
5. From the **Layout** drop-down menu, select **Booklet**.

6. If you are printing a large booklet, select a number of **Printed sheets per bundle**.
 - a. Click **Options® Layout Options**.
 - b. From the **Printed sheets per bundle** drop-down menu, select a number of printed sheets per bundle.
7. Click **OK** to close any printer software dialog boxes that are open.
8. Print the document.

 NOTE: For help binding and assembling the booklet, see [Assembling a Booklet](#).

Assembling a Booklet

1. Flip the printed stack of papers over in the paper exit tray.
2. Take the first bundle from the stack, fold it in half, and then set it aside with the front page down.
3. Take the next bundle from the stack, fold it in half, and then stack it with the front page down on top of the first bundle.



4. Stack the rest of the bundles with the front page down, one on top of the other, until the booklet is complete.
5. Bind the bundles together to complete the booklet.



Duplexing a Print Job (Two-Sided Printing)

Automatic Duplex

Automatic duplex allows you to print your document on both sides of the paper without having to manually re-orient the sheets. Make sure:

- You installed the optional duplex unit.
- You loaded letter size or A4 plain paper. You cannot duplex-print on envelopes, card stock, or

photo paper.

1. Turn on your computer and printer, and make sure they are connected.
2. Load the paper. For more information, see [Loading Paper](#).
3. With your document open, click **File® Print**.
4. Click **Preferences, Properties, Options, or Setup** (depending on the program or operating system).
5. Click the **Advanced** tab, and then select the **2-sided printing** check box.
6. From the drop-down list, select **Automatic**.
7. Select how you want to bind your pages.
8. After customizing your settings, click **OK**.

The **Printing Preferences** dialog box closes.

9. Click **OK** or **Print**.

Manual Duplex

Manual duplex allows you to print your document on both sides of the paper. The printer prints the odd-numbered pages of the document on the front sides of the paper. Reload the document with the blank side of the paper facing down, and print the even-numbered pages of the document on the back sides of the paper.

1. Turn on your computer and printer, and make sure they are connected.
2. Load the paper. For more information, see [Loading Paper](#).
3. With your document open, click **File® Print**.
4. Click **Preferences, Properties, Options, or Setup** (depending on the program or operating system).
5. Click the **Advanced** tab, and then select the **2-sided printing** check box.
6. From the drop-down list, select **Manual**.
7. Select how you want to bind your pages.
8. After customizing your settings, click **OK**.

The **Printing Preferences** dialog box closes.

9. Click **OK** or **Print**.
10. When all the odd-numbered pages have exited the printer, follow the instructions on your computer screen.

Canceling a Print Job

Sent From a Local Computer

There are two ways to cancel a print job sent from a computer that is connected to the printer by a USB cable.

From the Printers folder:

1. *In Windows Vista™:*
 - a. Click  **Control Panel**.
 - b. Click **Hardware and Sound**.
 - c. Click **Printers**.

In Windows® XP, click **Start** ® **Settings**® **Control Panel**® **Printers and Other Hardware**® **Printers and Faxes**.

In Windows 2000, click **Start** ® **Settings**® **Printers**.

2. Right-click the **Dell 968 AIO Printer** icon.
3. Click **Open**.
4. Select the job you want to cancel from the list that appears.
5. From the **Document** menu, click **Cancel**.

From the Printing Status window:



The Printing Status window automatically opens at the bottom-right part of your screen when you send a print job. Click **Cancel Printing** to cancel the current print job.

From the Taskbar:

1. Double-click the printer icon  at the bottom-right portion of your computer screen or the Taskbar.
2. Right-click the print job that you want to cancel.
3. Click **Cancel**.

Sent From a Bluetooth-Enabled Device

From the printer:

- Press the **Cancel** button  to cancel the print job and terminate the Bluetooth connection.
- Press the **Power** button  to cancel the print job, terminate the Bluetooth connection, and turn the printer off.

From the Bluetooth-enabled device:

See the documentation that came with your device for information.

Sent From a Computer Over a Wireless Network

1. *In Windows Vista:*

- a. Click  **Control Panel**.
- b. Click **Hardware and Sound**.
- c. Click **Printers**.

In Windows XP, click **Start** [®] **Settings** [®] **Control Panel** [®] **Printers and Other Hardware** [®] **Printers and Faxes**.

In Windows 2000, click **Start** [®] **Settings** [®] **Printers**.

2. Right-click the **Dell 968 AIO Printer** icon.
 3. Click **Open**.
 4. Select the job you want to cancel from the list that appears.
 5. From the **Document** menu, click **Cancel**.
-

Changing Printing Preferences Defaults

When you send a document or photo to print, you can specify various settings such as print on both sides of the paper, print in higher or lower quality, print only in black and white, and more. If you have preferred settings, you can make these the default so you do not have to specify your printing preferences each time you send a print job.

To make your preferred settings the default print settings for most programs, open the Printing Preferences dialog box from the Printers folder.

1. *In Windows Vista:*

- a. Click  **Control Panel**.
- b. Click **Hardware and Sound**.
- c. Click **Printers**.

In Windows XP, click **Start** [®] **Settings** [®] **Control Panel** [®] **Printers and Other Hardware** [®] **Printers and Faxes**.

In Windows 2000, click **Start** [®] **Settings** [®] **Printers**.

2. Right-click the **Dell 968 AIO Printer** icon.
3. Select **Printing Preferences**.
4. Change the settings that you want to set as default when printing from most programs.

From the **Print Setup** tab, you can:

- Change the default print quality to **Automatic**, **Draft**, **Normal**, or **Photo**.
- Change the default media type and paper size.

- Make black and white printing and borderless printing the default setting.
- Change the default orientation.
- Change the default number of copies.

From the Advanced tab, you can:

- Make automatic two-sided printing (duplex) the default.
- Extend dry time when duplexing print jobs by default.
- Specify layouts that you want to set as default.

From the Maintenance tab:

There are no print settings to set as default from the **Maintenance** tab. From here, you can

- Install, clean, and align ink cartridges.
- Print a test page.
- Get information on sharing your printer on a network.

Troubleshooting

- [Setup Problems](#)
- [Error Messages](#)
- [Avoiding Jams and Misfeeds](#)
- [Paper Problems](#)
- [Printing Problems](#)
- [Copying Problems](#)
- [Scanning Problems](#)
- [Faxing Problems](#)
- [Networking Problems](#)
- [Memory Card Problems](#)
- [Improving Print Quality](#)
- [General Guidelines for Selecting or Loading Print Media](#)

If the printer does not work, ensure that the printer is properly connected to the electrical outlet and computer, if using a computer.

For more help and to check the latest information on troubleshooting your printer, please visit <http://support.dell.com/support>.

Setup Problems

Computer Problems

Verify your printer is compatible with your computer.

The printer supports Windows Vista™, Windows® XP, and Windows 2000 only.

Windows ME, Windows 98, and Windows 95 are not supported by this printer.

Make sure you turned on both your printer and your computer.

Check the USB cable.

- Ensure the USB cable is firmly connected to your printer and your computer.
- Shut down the computer, reconnect the USB cable as shown on the Setting Up Your Printer poster, and then restart the computer.

If the software installation screen does not appear automatically, install the software manually.

1. Insert the Drivers and Utilities CD.
2. *In Windows Vista*, click  **Computer**.
In Windows XP, click **Start** **My Computer**.
In Windows 2000, double-click **My Computer** from your desktop.
3. Double-click the **CD-ROM drive** icon, and then double-click **setup.exe**.
4. When the printer software installation screen appears, click **Using a USB cable** or **Using a wireless network**.
5. Follow the instructions on your screen to complete the installation.

Determine if the printer software is installed.

In Windows Vista:

1. Click  **Programs**.
2. Click **Dell Printers**.

In Windows XP and Windows 2000:

Click **Start**® **Programs** or **All Programs**® **Dell Printers**® **Dell 968 AIO Printer**.

If the printer does not appear in the list of printers, the printer software is not installed. Install the printer software. For more information, see [Removing and Reinstalling Software](#).

Correct communication problems between the printer and the computer.

- Remove the USB cable from your printer and your computer. Reconnect the USB cable to your printer and your computer.
- Turn off the printer. Unplug the printer power cable from the electrical outlet. Reconnect the printer power cable into the electrical outlet, and turn on the printer.
- Restart your computer.

Set your printer as the default printer.

1. *In Windows Vista:*

- a. Click  **Control Panel**.
- b. Click **Hardware and Sound**.
- c. Click **Printers**.

In Windows XP, click **Start**® **Control Panel**® **Printers and Other Hardware**® **Printers and Faxes**.

In Windows 2000, click **Start**® **Settings**® **Printers**.

2. Right-click the **Dell 968 AIO Printer** icon.
3. Select **Set as Default Printer**.

Printer won't print and print jobs are stuck in the print queue.

Check for multiple instances of the printer installed on your computer.

1. *In Windows Vista:*

- a. Click  **Control Panel**.
- b. Click **Hardware and Sound**.
- c. Click **Printers**.

In Windows XP, click **Start**® **Control Panel**® **Printers and Other Hardware**® **Printers and Faxes**.

In Windows 2000, click **Start® Settings® Printers**.

2. Check for multiple objects for your printer.
3. Print a job to each of these print objects to see which printer is active.
4. Set that print object as the default printer:
 - a. Right-click the **Dell 968 AIO Printer** icon.
 - b. Click **Set as Default Printer**.
5. Delete the other copies of the print object by right-clicking the printer name and selecting **Delete**.

To prevent multiple instances of the printer in your **Printers** folder, make sure you always plug the USB cable back into the same USB port that was originally used for the printer. Also, do not install printer drivers multiple times from the Drivers and Utilities CD.

Printer Problems

Ensure the printer power cable is firmly connected to the printer and the electrical outlet.

Determine if the printer has been held or paused.

1. *In Windows Vista*:
 - a. Click  **Control Panel**.
 - b. Click **Hardware and Sound**.
 - c. Click **Printers**.

In Windows XP, click **Start® Control Panel® Printers and Other Hardware® Printers and Faxes**.

In Windows 2000, click **Start® Settings® Printers**.

2. Right-click the **Dell 968 AIO Printer** icon.
3. Make sure **Pause Printing** is not selected. If **Pause Printing** is selected, click it to clear the option.

Check for blinking lights on the printer.

For more information, see [Error Messages](#).

Ensure you installed the ink cartridges correctly and removed the sticker and tape from each cartridge.

Make sure you loaded the paper correctly.



For more information, see [Loading Paper](#).















Make sure the printer is not connected to a PictBridge-enabled camera.



For more information, see [Printing Photos From a PictBridge-Enabled Camera](#).













Error Messages





For more help and to check the latest information on troubleshooting your printer, please visit <http://support.dell.com/support>.



Error Message:	What it indicates:	Solution:
Cartridge Alignment Alignment problem. Verify tape removed from cartridges, run a few cleaning cycles or check troubleshooting. Press  to retry.	The tape was not removed from the ink cartridges before the cartridges were installed.	Remove the tape from the ink cartridges. For more information, see Replacing Ink Cartridges .
Cartridge Error Left cartridge incorrect. Replace cartridge. OR Right cartridge incorrect. Replace cartridge. OR Cartridges are in the wrong positions. Please reverse the cartridges	One or more of the ink cartridges is inserted in the wrong carrier.	Insert the black or photo cartridge in the left carrier and the color cartridge in the right. For more information, see Replacing Ink Cartridges .
Cartridge Error Faxes ready to print but cartridges unavailable. Install proper cartridges to print	One or more of the ink cartridges is inserted in the wrong carrier.	Insert the black or photo cartridge in the left carrier and the color cartridge in the right. For more information, see Replacing Ink Cartridges .
Cartridge Error Only Photo Cartridge installed. Insert Color or Black Cartridge. Press  to exit	The photo cartridge is the only cartridge installed.	Insert the black cartridge in the left carrier or the color cartridge in the right. For more information, see Replacing Ink Cartridges .
Cartridge Error See User's Guide	The printer detects a critical cartridge failure.	Remove the ink cartridges and unplug the printer. Plug the printer in and turn it on, and then reinsert the cartridges. For more information, see Replacing Ink Cartridges . If the error message returns, contact Customer Support. For more information, go to support.dell.com .
Cartridge Missing Black Cartridge missing.		Insert a black or photo cartridge in the left cartridge carrier. For more information, see Replacing Ink Cartridges .

Press  to print process black		
Cartridge Missing Color Cartridge missing. Press  to print grayscale		Insert a color cartridge in the right cartridge carrier. For more information, see Replacing Ink Cartridges .
Critically Low Ink Document in Memory. Replace Cartridge to Print.	There is not enough ink to complete the print job.	Replace the ink cartridge, and align the new cartridges. The printer continues to print the remaining pages.
Fax Mode Digital Line Detected. Please connect to a standard phone line.	You connected the printer to a DSL wall jack. The printer can only fax using an analog signal.	Install a DSL filter before connecting your printer to the wall jack. For more information, see Setting Up the Printer With External Devices .
Fax Mode Failed to Connect OR No Answer	The printer could not connect to the receiving fax machine.	Make sure the number you entered is a working fax number. Try your fax again later.
Fax Mode Memory Full. Try setting to Scan After Dial	The broadcast fax job was too big for the printer memory to hold with the current settings.	Set the printer to Scan After Dial to use less memory. For more information, see Dialing and Sending Menu .
Fax Mode Phone Line Error	The printer did not detect a dial tone, or the call timed out before you entered a number using on-hook dialing.	Check your fax connections. For more information, see Setting Up the Printer With External Devices .
Fax Mode Unrecoverable Fax Error	Fax mode is unavailable due to a critical error.	Contact Customer Support. For more information, go to support.dell.com .
Fax Mode Unsupported Fax Mode	The Auto Fax Conversion option is off, and the receiving fax machine does not support color or the resolution of the fax you are sending.	Turn Auto Fax Conversion on. <ol style="list-style-type: none"> 1. From the main menu, press the up or down Arrow button   to scroll to Fax, and then press the Select button . 2. Press the down Arrow button  to scroll to Fax Setup, and then press the Select button . 3. Press the up or down Arrow button   to scroll to Dialing and Sending, and then press the Select button . 4. Press the up or down Arrow button   to scroll to Auto Fax Conversion, and then press the left or right Arrow button   to

		<p>scroll to On.</p> <p>5. Press the Back button .</p>
Hardware Error: [XXXX]. Consult User's Guide	If the LCD displays Hardware Error followed by a four-digit number, an advanced error has occurred.	Contact Customer Support. For more information, go to support.dell.com .
Ink Low	The ink cartridge is running low on ink. The Ink Low error occurs when your ink cartridges reach levels of 25 percent, 15 percent, and 10 percent remaining.	Replace the ink cartridge. For more information, see Replacing Ink Cartridges .
<ul style="list-style-type: none"> • Black Ink Low. Order supplies at www.dell.com/supplies • Color Ink Low. Order supplies at www.dell.com/supplies • Photo Ink Low. Order supplies at www.dell.com/supplies • Black and Color Ink Low. Order supplies at www.dell.com/supplies • Photo and Color Ink Low. Order supplies at www.dell.com/supplies 	The ink cartridge level is below 5%.	Replace the ink cartridge. For more information, see Replacing Ink Cartridges .
Invalid Device The attached device is not a PictBridge or a supported Mass Storage Class Device. Please disconnect and refer to user manual.		Attach a PictBridge-enabled camera or a USB key into the PictBridge port.
Invalid Device The attached device is not a supported Bluetooth device. Please disconnect and refer to user manual.		Attach a USB Bluetooth adapter into the PictBridge port.
Invalid Device The attached USB device is not supported. Please disconnect and refer to user manual.		Make sure the USB device you are attempting to use is supported by the printer. For more information, see Printing From a Memory Card or USB Key .
Invalid Paper Type Faxes in memory. Load plain paper and press	The printer received incoming faxes, but there is no plain paper loaded in the input tray.	Load plain paper in the input tray, and then press the Select button  .

		
<p>Invalid Paper Type</p> <p>Fax Received. Load Paper, then select size to print fax.</p>	<p>There is an incoming fax, but the paper loaded is not supported.</p>	<p>Load plain Letter, Legal, or A4 size paper into the input tray, and then select the paper size.</p>
<p>Media Mismatch</p>	<p>You have enabled Tray Linking and set the paper type to Automatic or Auto-Detect, but the paper loaded is not plain paper.</p>	<p>Press the Select button  to continue printing. Otherwise, press the Cancel button , and then load plain paper.</p>
<p>Multiple Card Error</p>	<p>One or more memory cards or a USB key were inserted before the printer was powered on.</p>	<p>Remove all memory cards, and then press the Select button .</p>
<p>Out of Memory.</p> <p>Unable to complete multiple copies. Press .</p>	<p>The printer does not have enough memory to scan all the originals loaded into the ADF.</p>	<p>Press the Select button  to print the pages that were scanned. Reload the originals that were not scanned, and make copies of them.</p>
<p>Paper Load Error</p> <p>Load original to be scanned into the Automatic Document Feeder, then press .</p>	<p>Your original document was removed from the ADF before it was scanned.</p>	<p>Load the original into the ADF, and then press the Select button .</p>
<p>Paper Mismatch</p> <p>Fax received. Load paper in Tray X, then select size to print fax.</p>	<p>The selected paper size or type is not supported for fax printing.</p>	<ol style="list-style-type: none"> 1. Load plain letter or A4 paper into the paper tray indicated. 2. Highlight the matching paper size, and press the Select button  to print the fax.
<p>Paper Mismatch</p> <p>Invalid paper size for this mode. Please change paper and update selection.</p>	<p>The selected paper size is not supported for photo printing.</p>	<p>Press the Select button , and then choose a different paper size.</p>
<p>Paper or Photo Size Error.</p> <p>Change paper or photo size setting in Camera or printer defaults.</p>	<p>The size of the photo is greater than the paper size set.</p>	<ul style="list-style-type: none"> • Choose a photo size that is smaller than the paper size. • Choose a paper size that is greater than the photo size. If you want to print a borderless picture, choose a paper size that is the same size as the photo.
<p>Paper Out Tray#</p> <p>Load paper, then press .</p>	<p>The indicated paper tray is empty. If you have an optional input paper tray and you loaded paper into both trays, Tray Linking is not enabled.</p>	<p>Load paper, and then press the Select button .</p> <p>If you have a second tray, enable Tray Linking. For more information, see Understanding Tray Linking.</p>
<p>Paper Size/Type</p>	<p>The paper type or size in the tray is not supported for duplex</p>	<p>Load plain letter or A4 paper into the paper tray, and send your print job</p>

Plain Letter or A4 paper is required for 2-sided printing.	printing.	again.
Paper Tray Removed Insert Paper Tray, then press 	The paper tray was removed during printing.	Insert the paper tray, and then press the Select button  .
PictBridge Communication Error Disconnect and reconnect Camera.		<ol style="list-style-type: none"> 1. Disconnect the USB cable from the PictBridge port on the printer. 2. Turn the camera off, and then turn it back on. 3. Reconnect the USB cable to the PictBridge port on the front of the printer.
Print File Error Failed to find an application to print.	The computer failed to find an application to use to print the selected file.	Make sure your computer has the necessary applications to print Microsoft Office documents.
Print File Error Failed to retrieve the File from the Mass Storage Device.	The computer failed to retrieve the file from a memory card or a USB key.	Make sure that the memory card or USB key is not damaged.
Print File Mode No Documents present on memory device.	No documents of the supported file types were detected on the USB key.	Make sure that the memory card or USB key contains files that have *.DOC, *.XLS, *.PPT, *.PDF, *.RTF, *.DOCX, *.XLSX, *.PPTX, *.WPS, or *.WPD as filename extensions.
Printer Carrier Stall Check inside the printer for Obstructions, then press  .	A printhead carrier jam exists in the printer.	Clear the carrier jam, and then press the Select button  .
Proof Sheet Error Could not detect a proof sheet.	The printer could not scan the proof sheet.	Reprint the proof sheet, and then try again.
Proof Sheet Error No images have been selected.	The proof sheet is being scanned without any images selected.	Select images on the proof sheet, and then try again.
Proof Sheet Error No photo/paper size selection has been made.	The printer did not detect a photo/paper size selection.	Make a photo/paper size selection, filling in the bubble completely, and then try again.
Proof Sheet Error No proof sheet information	The memory card or USB key was removed, or the printer was powered off. The information on the proof sheet is no longer valid.	Press the Cancel button  to return to the Photo Proof Sheet menu, and then print another proof sheet. For more information, see Printing Photos Using a Proof Sheet .
Proof Sheet Error	More than one selection was	Reprint the proof sheet, and then try

<p>Only one photo enhancement may be chosen at a time.</p> <p>OR</p> <p>Only one photo/size selection can be chosen at a time.</p>	<p>made in a category.</p>	<p>again.</p>
<p>Proof Sheet Error</p> <p>Some photos removed from card by computer</p>	<p>One or more of the photos selected on the proof sheet were removed from the memory card by the computer before you scanned the proof sheet.</p>	<p>Using the computer, move the photos back to the memory card, and then scan the proof sheet again. For more information, see the documentation that came with your camera.</p>
<p>Scan Error</p> <p>Unrecoverable Scan Error</p> <p>Press  to continue.</p>	<p>The scanner could not calibrate properly.</p>	<p>Press the Select button  to restart your printer.</p> <p>If the error message returns, contact Customer Support. For more information, go to support.dell.com.</p>
<p>Scan Mode</p> <p>The PIN entered is invalid for the computer selected.</p> <p>Enter a valid PIN or press  to select another computer.</p>	<p>The computer to which you are attempting to scan requires a PIN to allow the connection. The PIN you entered does not match the one set on the computer.</p>	<p>Contact the administrator of the network computer for assistance.</p>

Avoiding Jams and Misfeeds

You can avoid most jams and misfeeds by following these guidelines:

- Use media that follows the printer's media guidelines. For more information, see [Loading Paper](#).
- Make sure that the media is properly loaded in the input tray.
- Do not overload the input tray.
- Do not remove media from the input tray while printing.
- Flex, fan, and straighten the paper before loading.
- Do not use creased, damp, or curled paper.
- Orient the media according to the instructions for the printer.

Paper Problems

Make sure you loaded the paper correctly.

For more information, see [Loading Paper](#).

Use only paper recommended for your printer.

For more information, see [Print Media Guidelines](#).

Use a smaller amount of paper when printing multiple pages.

For more information, see [Print Media Guidelines](#).

Make sure the paper is not wrinkled, torn, or damaged.

Check for a paper jam.

If the paper jam is near the paper input tray:

1. Remove the paper tray.



2. Pull firmly on the paper to remove it.
3. Replace the paper tray.



4. Press the **Select** button .
5. Resend your print job to print any missing pages.

If the paper jam is not visible:

1. Turn off the printer.
2. Lift the scanner base unit.



3. Firmly grasp the paper, and gently pull it from the printer.
4. Close the scanner base unit.
5. Turn on the printer, and print the document again.

If the jam is located in the duplex unit or near the rear access door:

1. If you have a duplex unit, remove it.

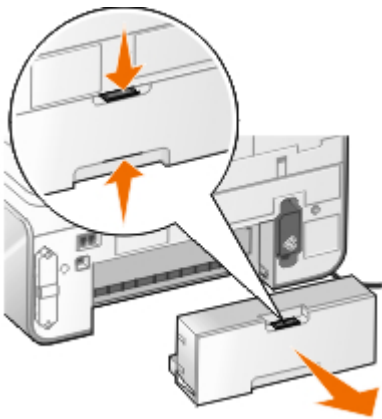

2. Open the rear access door.
3. Firmly grasp the paper, and gently pull it from the printer.
4. Close the rear access door.
5. Reinstall the duplex unit.
6. Press the **Select** button  to continue printing.

If the paper jam occurs near the ADF:

1. Lift the ADF cover located to the left of the ADF input tray.



2. Firmly grasp the paper, and then gently pull it from the printer.
3. Close the ADF cover.



4. Press the **Select** button .
 5. Resend your print job to print any missing pages.
-

Printing Problems

Check the ink levels, and install new print cartridges if necessary.

For more information, see [Replacing Ink Cartridges](#).

Make sure you remove individual sheets from the paper exit tray.

To avoid ink smudging when you are using the following media, remove each sheet as it exits, and allow it to dry:

- Photo paper
- Glossy paper
- Transparency
- Labels
- Envelopes
- Iron-on transfers

Extend dry time when duplexing print jobs

If ink is smeared on the bottom of the pages of your duplex print jobs, extend the time for the printed side to dry before the duplex unit feeds the paper back into the printer, and prints on the other side.

NOTE: You will need to wait a few seconds longer for your duplex print jobs to finish if you turn this feature on.

To make this feature a default for all duplex print jobs:

1. *In Windows Vista:*
 - a. Click  **Control Panel**.

b. Click **Hardware and Sound**.

c. Click **Printers**.

In Windows XP, click **Start® Control Panel® Printers and Other Hardware® Printers and Faxes**.

In Windows 2000, click **Start® Settings® Printers**.

2. Right-click the **Dell 968 AIO Printer** icon.

3. Select **Printing Preferences**.

The **Printing Preferences** dialog box opens.

4. Click the **Advanced** tab.

5. From the **2-Sided Printing** area, select **Extend dry time**.

6. Click **OK**.

To apply this feature to your current duplex print job only:

1. With your document open, click **File® Print**.

The **Print** dialog box opens.

2. Click **Preferences, Properties, Options, or Setup** (depending on the program or operating system).

The **Printing Preferences** dialog box opens.

3. Click the **Advanced** tab.

4. From the **2-Sided Printing** area, select **Extend dry time**.

5. Click **OK**.

Free up memory resources on your computer when print speed is slow

- Close all applications not in use.
- Try minimizing the number and size of graphics and images in your document.
- Consider purchasing more Random Access Memory (RAM) for your computer.
- Remove fonts that you rarely use from your system.
- Uninstall the printer software, and then reinstall it. For more information, see [Removing and Reinstalling Software](#).
- Select a lower print quality from the Printing Preferences dialog box.

Make sure you loaded the paper correctly.

For more information, see [Loading Paper](#).

Copying Problems

Check for blinking lights or error messages on the printer.

For more information, see [Error Messages](#).

Make sure the scanner glass is clean.

Gently wipe the scanner glass as well as the thin strip of glass beside it with a clean, lint-free cloth dampened with water.

Remove image patterns from magazines or newspapers.

1. *In Windows Vista:*

- a. Click  **Programs**.
- b. Click **Dell Printers**.
- c. Click **Dell 968 AIO Printer**.

In Windows XP or Windows 2000:

Click **Start**® **Programs** or **All Programs**® **Dell Printers**® **Dell 968 AIO Printer**.

2. Select **Dell All-In-One Center**.

The **Dell All-In-One Center** opens.

3. Click **See More Copy Settings**, and then click **Advanced**.

The **Advanced Copy Settings** dialog box opens.

4. From the **Image Patterns** tab, select **Remove image patterns from magazine/newspaper (descreen)**, and then click **OK**.

5. Click **Copy Now**.

Make sure the document or photo is loaded correctly on the scanner glass or into the Automatic Document Feeder.

For more information, see [Loading Original Documents](#).

Check paper sizes.

Make sure the paper size being used matches the size you selected on the operator panel or the **Dell All-In-One Center**.

Scanning Problems

Check for blinking lights and error messages on the printer.

For more information, see [Error Messages](#).

Check the USB cable.

- Ensure the USB cable is firmly connected to your printer and your computer.

- Shut down the computer, reconnect the USB cable as shown on the Setting Up Your Printer poster, and then restart the computer.

Determine if the printer software is installed.

In Windows Vista:

1. Click  **Programs**.
2. Click **Dell Printers**.

In Windows XP or Windows 2000:

Click **Start**  **Programs** or **All Programs**  **Dell Printers**  **Dell 968 AIO Printer**.

If the printer does not appear in the list of printers, the printer software is not installed. Install the printer software. For more information, see [Removing and Reinstalling Software](#).

Correct communication problems between the printer and the computer.

- Remove and then reconnect the USB cable from your printer and your computer.
- Turn off the printer. Unplug the printer power cable from the electrical outlet. Reconnect the printer power cable into the electrical outlet, and turn on the printer.
- Restart your computer.

Change the scan resolution to a lower value if scanning takes too long or freezes the computer.

1. *In Windows Vista:*

- a. Click  **Programs**.
- b. Click **Dell Printers**.
- c. Click **Dell 968 AIO Printer**.

In Windows XP and Windows 2000:

Click **Start**  **Programs** or **All Programs**  **Dell Printers**  **Dell 968 AIO Printer**.

2. Select **Dell All-In-One Center**.

The **Dell All-In-One Center** opens.

3. Click **See More Scan Settings**.
4. Select a lower scan resolution from the **Select Scan Quality** menu.
5. Click **Scan Now**.

Change the scan resolution to a higher value if the scanned image quality is poor.

1. *In Windows Vista:*

- a. Click  **Programs**.
- b. Click **Dell Printers**.

- c. Click **Dell 968 AIO Printer**.

In Windows XP and Windows 2000:

Click **Start® Programs** or **All Programs® Dell Printers® Dell 968 AIO Printer**.

2. Select **Dell All-In-One Center**.

The **Dell All-In-One Center** opens.

3. Click **See More Scan Settings**.
4. Select a higher scan resolution from the **Select Scan Quality** menu.
5. Click **Scan Now**.

Remove image patterns from magazines or newspapers.

1. *In Windows Vista:*

- a. Click  **Programs**.
- b. Click **Dell Printers**.
- c. Click **Dell 968 AIO Printer**.

In Windows XP and Windows 2000:

Click **Start® Programs** or **All Programs® Dell Printers® Dell 968 AIO Printer**.

2. Select **Dell All-In-One Center**.

The **Dell All-In-One Center** opens.





3. Click **See More Scan Settings**, and then click **Advanced**.

The **Advanced Scan Settings** dialog box opens.

4. From the **Image Patterns** tab, select **Remove image patterns from magazine/newspaper (descreen)**, and then click **OK**.
5. Click **Scan Now**.

Choose another application if scanning to an application fails.

Using the operator panel

1. From the main menu, press the up or down **Arrow** button   to scroll to Scan, and then press the **Select** button .
2. From Scan To, press the left or right **Arrow** button   to choose another application.

Using the computer

1. *In Windows Vista:*
 - a. Click  **Programs**.
 - b. Click **Dell Printers**.

c. Click **Dell 968 AIO Printer**.

In Windows XP and Windows 2000:

Click **Start® Programs** or **All Programs® Dell Printers® Dell 968 AIO Printer**.

2. Select **Dell All-In-One Center**.

The **Dell All-In-One Center** opens.

3. From the **Send scanned images to:** drop-down menu, choose another application.

NOTE: If the program you want to use is not listed, select **Search for more** in the drop-down menu. On the next screen, click **Add** to locate and add your program to the list.

Make sure the document or photo is loaded correctly on the scanner glass or into the ADF.

For more information, see [Loading Original Documents](#).

Make sure the scanner glass is clean.

Gently wipe the scanner glass, as well as the thin strip of glass beside it, with a clean, lint-free cloth dampened with water.

Faxing Problems

Make sure you turned on both your printer and your computer, and the USB cable is properly inserted.













Ensure the printer is connected to an active analog telephone line.

- When using DSL broadband service, make sure you have a DSL filter installed on your phone cord. Contact your Internet Service Provider for more information.
- Make sure your computer is not connected to the Internet by dial-up modem when trying to fax using your computer modem.

When using an external modem, make sure it is turned on and it is correctly connected to your computer.

When the printer's memory is full, print a fax activity report and resend pages that were not transmitted.













When sending color pages, set the printer to scan the original documents after dialing.

1. From the main menu, press the up or down **Arrow** button   to scroll to Fax, and then press the **Select** button .
2. Press the down **Arrow** button  to scroll to Fax Setup, and then press the **Select** button .
3. Press the up or down **Arrow** button   to scroll to Dialing and Sending, and then press the **Select** button .
4. Press the up or down **Arrow** button   to scroll to Scan, and then press the left or right **Arrow** button   to scroll to After Dial.
5. Press the **Back** button  to save the changes.











NOTE: This setting is applicable for all subsequent fax jobs.

If caller ID is not working, make sure that you selected the correct Caller ID pattern.

The Caller ID detection pattern is determined by the country or region you selected during initial setup. If phones in your country use two detection patterns, call your telecommunications company to determine which pattern it subscribes to.

1. From the main menu, press the up or down **Arrow** button   to scroll to Fax, and then press the **Select** button .
2. Press the down **Arrow** button  to scroll to Fax Setup, and then press the **Select** button .
3. Press the up or down **Arrow** button   to scroll to Ringing and Answering, and then press the **Select** button .
4. Press the down **Arrow** button  to scroll to Caller ID pattern, and then press the left or right **Arrow** button   to select an option.
 - Select Pattern 1 if telephones in your country subscribe to a detection pattern using frequency-shift keying (FSK).
 - Select Pattern 2 if telephones in your country subscribe to a detection pattern using dual tone multifrequency (DTMF).
5. Press the **Back** button .

Set the quality of the outgoing fax to Ultrafine.

1. From the main menu, press the up or down **Arrow** button   to scroll to Fax, and then press the **Select** button .
2. Press the up or down **Arrow** button   to scroll to Edit Fax Settings, and then press the **Select** button .
3. Press the up or down **Arrow** button   to scroll to Quality, and then press the left or right **Arrow** button   to scroll to Ultrafine.
4. Press the **Back** button .

If the quality of the received fax is still poor, the fax machine at the receiving end may be limiting the fax quality. Any adjustments that you make on your printer do not affect the quality of faxes received at the other end.

Networking Problems

Check power

Make sure the printer power light is on.

Check cable

- Make sure the power cable is connected to the printer and to the electrical outlet.

- Make sure the USB cable is not connected.

Check your network connection.

Make sure the printer is connected to a working network connection.

Reboot the computer

Turn off and restart the computer.

Remove and reinstall the network adapter

1. Turn off the printer, and unplug the power cable from the electrical outlet.
2. Grasp the adapter by the side tabs—not the antenna—and pull to remove it. For more information, see [Removing and Reinstalling the Adapter](#).
3. Reinstall the adapter following the installation instructions. For more information, see [Installing the Adapter](#).

Check the network adapter documentation for setup and usage information.

Memory Card Problems

Make sure that the type of memory card you are using can be used in the printer.

For more information, see [Printing From a Memory Card or USB Key](#).

Insert only one memory card at a time.

Insert the memory card until it stops.

The printer will not read the contents of the memory card if it is not properly inserted into the memory card slot.

When printing images from a memory card, make sure the file format of the images is supported by the printer.

Only images in JPEG and a limited set of TIFF formats can be printed directly from the memory card. Only TIFF formats created directly from digital still cameras and not modified by any application are supported. If you want to print photos stored on the memory card in a different file format, the photos must be transferred to your computer before printing.

Make sure the printer is not connected to a PictBridge-enabled camera.

For more information, see [Printing Photos From a PictBridge-Enabled Camera](#).

Improving Print Quality

If you are not satisfied with the print quality of your documents, there are several different ways to improve the print quality.

- Use the appropriate paper. For example, use Dell™ Premium Photo Paper if you are printing photos

with a photo ink cartridge.

- Select a higher print quality.

To select a higher print quality:

1. With your document open, click **File® Print**.

The **Print** dialog box opens.

2. Click **Preferences**, **Properties**, **Options**, or **Setup** (depending on the program or operating system).

The **Printing Preferences** dialog box opens.

3. On the **Print Setup** tab, select a higher quality setting.

4. Print your document again.

5. If the print quality does not improve, try aligning or cleaning the ink cartridges. For more information, see [Aligning Ink Cartridges](#) and [Cleaning the Ink Cartridge Nozzles](#).

For additional solutions, go to <http://support.dell.com/support>.

General Guidelines for Selecting or Loading Print Media

- Attempting to print on damp, curled, wrinkled, or torn paper can cause paper jams and poor print quality.
- Use only high-quality, copier-grade paper for the best print quality.
- Avoid paper with embossed lettering, perforations, or a texture that is too smooth or rough. Paper jams may occur.
- Store paper in its packaging until you are ready to use it. Place cartons on pallets or shelves, not on the floor.
- Do not place heavy objects on top of the media, whether or not it is packaged.
- Keep paper away from moisture or other conditions that can cause it to wrinkle or curl.
- Store unused paper at temperatures ranging between 15°C and 30°C (59°F and 86°F). The relative humidity should be between 10% and 70%.
- During storage, you should use moisture-proof wrap, such as a plastic container or bag, to prevent dust and moisture from contaminating the paper.

Printing From a Memory Card or USB Key

- [Printing Photos](#)
- [Altering Photos Before Printing](#)
- [Printing Microsoft Office Files](#)

Most digital cameras use a memory card to store photos. The printer supports the following digital media:

- Compact Flash Type I and II
- Memory Stick
- Memory Stick PRO
- Memory Stick Duo (with adapter)
- Mini SD (with adapter)
- Microdrive
- Secure Digital
- Secure Digital High Capacity
- MultiMedia Card
- xD-Picture Card

Memory cards should be inserted with the label facing up. The card reader has two slots to accommodate these media and a small light that blinks indicating the card is being read or is transmitting data.

- ➡ **NOTICE:** Do not remove the memory card or USB key, or touch the printer near the area of the memory card or USB key while actively reading, writing, or printing from these devices. Data corruption can occur.

The connector that is used for PictBridge may also be used for accessing information stored on USB Flash Drive devices. When you insert a memory card or USB key, the printer automatically switches to **Photo** mode.

- 📄 **NOTE:** Do not insert more than one memory card or USB key at a time.





- 📄 **NOTE:** The printer supports FAT32 data format. Files stored in NTFS should be converted to FAT32 data format.

Printing Photos

Viewing or Printing Photos

1. Insert a memory card or USB key.

The printer automatically switches to **Photo** mode.

2. Press the **Select** button  to access the **Photo Card Mode** menu.
3. From Browse and Print Photos, press the **Select** button .
4. Press the left or right **Arrow** button  to scroll through the photos on the memory card or USB key.
5. Press the **Select** button  to select a photo for printing.
6. Press the up or down **Arrow** button  to specify the number of copies.



Repeat steps 5–6 for each photo you want to print.

7. Press the **Start** button  to preview your selections.

The **Photo Print Preview** menu opens.





8. Press the left or right **Arrow** button  to scroll through the thumbnail previews of your printed photos.

To change the print settings:

- a. Press the **Menu** button  to open the **Photo Print Settings** menu.
 - b. After adjusting the settings, press the **Back** button  to return to the **Photo Print Preview** menu.
9. Press the **Start** button  to print your photos.

 **NOTE:** Only photos in JPG and a limited set of TIFF formats can be printed directly from the memory card or USB key. If you want to print photos stored on the memory card or USB key in a different file format, the photos must be transferred to your computer before printing.

Saving Photos to Your Computer

1. Insert the memory card or USB key. The printer automatically switches to the **Photo** mode.
2. Press the up or down **Arrow** button  to scroll to Save Photos to Computer, and then press the **Select** button .
3. Press the up or down **Arrow** button  to choose a file destination, and then press the **Select** button .
4. Press the **Start** button .





The **Memory Card Manager** launches on your computer.

5. Follow the instructions on the **Memory Card Manager** dialog box to transfer the photos to your computer.







Viewing a Slide Show

You can view all the photos stored on a memory card or USB key through a slide show.

1. Insert a memory card or USB key. The printer automatically switches to **Photo** mode.

2. Press the **Select** button  to access the **Photo Card Mode** menu.
3. Press the up or down **Arrow** button  to scroll to View Slideshow, and then press the **Select** button .
4. Press the up or down **Arrow** button  to select the speed of the slide show, and then press the **Select** button .

Printing All Photos





1. Insert the memory card or USB key. The printer automatically switches to **Photo** mode.
2. Press the **Select** button  to access the **Photo Card Mode** menu.
3. Press the up or down **Arrow** button  to scroll to Print All Photos, and then press the **Select** button .
4. Press the up or down **Arrow** button  to choose the number of photos that will be printed on a page, and then press the **Select** button .
5. From the **Print Preview** menu, press the **Menu** button  to adjust the print settings and edit your photos, or press the **Start** button  to print your photos.

 **NOTE:** Only images in JPG and a limited set of TIFF formats can be printed directly from the memory card or USB key. If you want to print photos stored on the memory card or USB key in a different file format, the photos must be transferred to your computer before printing.

Printing a DPOF Selection

If your camera supports DPOF, you can specify which photos to print, and how many of each, while the memory card is still in the camera. The printer recognizes these settings when you insert the memory card into the printer.



 **NOTE:** If you specified a paper size in the DPOF selection, make sure the size of the paper loaded is not smaller than the size you specified.

1. Insert a memory card. The printer automatically switches to **Photo** mode.
2. Press the up or down **Arrow** button  to scroll to Print Camera Selections, and then press the **Select** button .
3. Press the **Select** button  to display the DPOF selection you specified.
A preview of the print job appears.
4. Press the **Start** button  to print the photos.







Printing Photos Using a Proof Sheet

1. Insert the memory card or USB key.

If the printer detects photos on the memory card or USB key, it automatically highlights Photo

mode. Otherwise, press the up or down **Arrow** button   to scroll to Photo, and then press the **Select** button .

 **NOTE:** Only images in JPEG and a limited set of TIFF formats can be printed directly from the memory card or USB key. If you want to print photos stored on the memory card or USB key in a different file format, the photos must be transferred to your computer before printing. For more information, see [Saving Photos to Your Computer](#).

2. Press the up or down **Arrow** button   to scroll to Photo Proof Sheet, and then press the **Select** button .
3. Press the up or down **Arrow** button   to specify which photos on the memory card or USB key to print on the proof sheet, and then press the **Select** button .

You can choose from	To
Print Sheet with All X Photos	Print all photos on the memory card or USB key on the proof sheet. "X" is the number of photos detected on the memory card or USB key.
Print most recent 25 photos	Print the 25 most recent photos on the proof sheet.
Print Sheet Using Date Range	Print only photos created in a certain date range. Press the Select button  , and then choose a date range.

4. Load plain letter or A4 paper, and then press the **Select** button . For more information, see [Loading Paper](#).

The proof sheet prints.

 **NOTE:** After printing a proof sheet, the printer automatically highlights **Scan Proof Sheet** in preparation for step 6.

5. Follow the instructions on the proof sheet to select which photos to print, and to choose a layout and paper type to use.

Fill in the circle with the red-eye icon below a photo to reduce the red-eye effect on the printout.



 **NOTE:** Make sure you completely fill in the circles when making selections.

6. Load the proof sheet facing down on the scanner glass, and then press the **Select** button . For more information, see [Loading Original Documents](#).

7. Load the photo paper. For more information, see [Loading Paper](#).

 NOTE: Make sure the size of the paper you loaded in the printer matches the paper size you specified in the proof sheet.

 NOTE: Photo/glossy paper is recommended for printing photos.

8. Press the **Start** button .

The printer scans the proof sheet and prints your selected photos.



 NOTICE: Do *not* remove the memory card or turn off the printer until the photos you selected in the photo proof sheet have been printed. The proof sheet becomes invalid when the memory card is removed from the printer or anytime the printer is turned off.

Altering Photos Before Printing

1. Insert a memory card or USB key. The printer automatically switches to **Photo** mode.

2. Press the **Select** button  to enter the **Photo Card Mode** menu.

3. From Browse and Print Photos, press the **Select** button .

4. Press the left or right **Arrow** button  to scroll to the photo you want to edit, and then press the **Select** button .

5. Press the **Menu** button .

The **Photo Menu** opens.

6. From Edit Photo, press the **Select** button .

The menu items appear beside the photo you want to edit.

7. Press the up or down **Arrow** button  to scroll through the menu items.

8. Press the left or right **Arrow** button  to scroll through the options for each menu item.





9. After altering your photos, press the **Back** button .

Printing Microsoft Office Files



1. Turn on your computer and printer, and make sure they are connected.

2. Insert a memory card into a card slot or a USB key into the PictBridge port.

The printer automatically switches to **Print Files** mode if there are only Microsoft Office files stored on the memory card or USB key. Only files that have filename extensions *.DOC, *.DOCX, *.PDF, *.PPT, *.PPTX, *.RTF, *.XLS, *.XLSX, *.WPD, and *.WPS are recognized.

 NOTE: The printer automatically switches to **Photo** mode if there are photos stored on the memory card or USB key. Press the **Back** button  to exit the **Photo** menu, and then press the up or down **Arrow** button  to scroll to Print Files. Press the **Select** button  to access the **Print Files Mode** menu.

3. Press the **Start** button  to access the **Print Files Selection** menu.

 **NOTE:** Press the **Select** button  to change the **Paper Handling** settings before selecting a file to print. After customizing your settings, press the **Back** button  to save your changes.

4. Press the up or down **Arrow** button  to scroll to the file that you want to print.

5. Press the **Start** button .

Specifications

- [Overview](#)
- [Environmental Specifications](#)
- [Power Consumption and Requirements](#)
- [Fax Mode Capabilities](#)
- [Print and Scan Mode Capabilities](#)
- [Operating System Support](#)
- [Memory Specifications and Requirements](#)
- [Media Types and Sizes](#)
- [Cables](#)

Overview

Memory	<ul style="list-style-type: none">• 32 MB SDRAM• 4 MB FLASH• 2 MB Fax
Connectivity	USB 2.0 high-speed
Duty cycle (average)	5,000 pages per month
Printer life	<ul style="list-style-type: none">• Printer: 18,000 pages• Scanner: 18,000 scans• ADF: 12,000 scans

Environmental Specifications

Temperature/Relative Humidity

Condition	Temperature	Relative humidity (non-condensing)
Operation	61° to 90° F	8 to 80%
Storage	34° to 140° F	5 to 80%
Shipping	-40° to 140° F	5 to 100%

Power Consumption and Requirements



Rated AC input	90–255 V
Rated frequency	47 Hz to 63 Hz
Minimum AC input	90 VAC
Maximum AC input	255 VAC
Maximum input current	1.0 A
Average power consumption	

Standby mode	< 10 W
Operational mode	<32 W

Fax Mode Capabilities

When you scan to fax, your document will scan in at 200 dpi (dots per inch). You can fax black and white documents.

For faxing to work properly, the printer must be able to access a computer connected to an active analog telephone line.

-  NOTE: If you are faxing over a telephone line connected to a DSL modem, install a DSL filter to avoid interference with the analog fax modem signal.
-  NOTE: ISDN (integrated service digital network) and cable modems are not fax modems and are not supported for faxing.

Print and Scan Mode Capabilities

Your printer can scan from 72 to 19,200 dpi. Although your printer has this capability, Dell™ recommends using the preset resolutions.

Print and scan resolution	Scan resolution	Print resolution	
		Photo/Glossy paper	All other media
Draft	150 x 150 dpi	600 x 600 dpi	300 x 600 dpi
Normal	300 x 300 dpi	1200 x 1200 dpi	600 x 600 dpi
Photo	600 x 600 dpi	4800 x 1200 dpi	1200 x 1200 dpi

Operating System Support

The printer supports:

- Windows Vista™
- Microsoft® Windows® XP Professional x64
- Microsoft Windows XP
- Microsoft Windows 2000

Memory Specifications and Requirements

Your operating system must meet the minimum system requirements.

Operating System	Processor speed (MHz)	RAM (MB)	Hard disk

Windows Vista	800 MHz Pentium® /Celeron®	512	20 GB (15 GB free space)
Microsoft Windows XP Professional x64	AMD Athlon 64, AMD Opteron, Intel Xeon with Intel EM64T support, Intel Pentium 4 with Intel EM64T support	256	1.5 GB
Microsoft Windows XP	Pentium II 300	128	500 MB
Microsoft Windows 2000	Pentium II 233	128	500 MB

Media Types and Sizes

Media type:	Sizes supported:	Load up to:
Plain paper	<ul style="list-style-type: none"> • Letter: 8.5 x 11 inches (216 x 279 mm) • A4: 8.27 x 11.69 inches (210 x 297 mm) • Legal: 8.5 x 14 inches (216 x 355.6 mm) • Executive: 7.25 x 10.5 inches (184.15 x 266.7 mm) • Statement: 8.5 x 5.5 inches (215.9 x 139.7 mm) 	150 sheets
Banner paper	<ul style="list-style-type: none"> • A4 Banner • Letter Banner 	20 sheets
Envelopes	<ul style="list-style-type: none"> • 9 Envelopes: 3 7/8 x 8 7/8 inches • 10 Envelopes: 4 1/8 x 9 1/2 inches • 6 3/4 Envelopes: 3 1/4 x 6 1/2 inches • 7 3/4 Envelopes: 3 7/8 x 7 1/2 inches • A2 Baronial Envelopes: 111 x 146 mm • B5 Envelopes: 176 x 250 mm • C5 Envelopes: 162 x 229 mm • C6 Envelopes: 114 x 162 mm • DL Envelopes: 110 x 220 mm • Chokey 3 Envelopes: 120 x 235 mm • Chokey 4 Envelopes: 90 x 205 mm • Chokey 40 Envelopes: 90 x 225 mm 	10 envelopes

	<ul style="list-style-type: none"> • Kakugata 3 Envelopes: 216 x 277 mm • Kakugata 4 Envelopes: 197 x 267 mm • Kakugata 5 Envelopes: 190 x 240 mm • Kakugata 6 Envelopes: 162 x 229 mm 	
Greeting cards, index cards, postcards, or photo cards	<ul style="list-style-type: none"> • Photo/Post card: 4 x 6 inches • Hagaki card (100 x 148 mm) • Index card: 3 x 5 inches • 3.5 x 5 inches 	25 cards
Photo/glossy or matte paper	<ul style="list-style-type: none"> • 8.5 x 11 inches (216 x 279 mm) • 4 x 6 inches (101.6 x 152.4 mm) 	50 sheets
Iron-on transfers	8.5 x 11 inches (216 x 279 mm)	10 mm stack
Transparencies	8.5 x 11 inches (216 x 279 mm)	50 transparencies
Custom size paper	<p>The paper must fit the following dimensions:</p> <ul style="list-style-type: none"> • Width: 3.0 – 8.5 inches (76 – 216 mm) • Length: 5.0 – 17.0 inches (127 – 432 mm) 	150 sheets

Cables

Your printer uses a Universal Serial Bus (USB) cable (sold separately).



Copying



- [Copying Documents](#)
 - [Collating Copies](#)
 - [Copying Photos](#)
 - [Copying a Two-Sided Document](#)
 - [Making a Duplex Copy](#)
 - [Changing Copy Settings](#)
-

Copying Documents

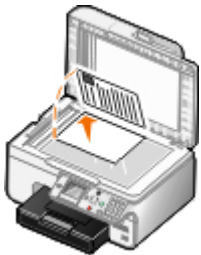

Using the Operator Panel

1. Turn on the printer.
2. Load the paper. For more information, see [Loading Paper](#).
3. Load your original document.



4. Press the **Menu** button  to change copy settings.
5. Press the **Start** button .

The copy is made in the currently specified copy selection (Color or Black).

 **NOTE:** If you press the **Start** button  without specifying a copy selection, the copy is printed in color by default.

Using Your Computer

1. Turn on your computer and printer, and make sure they are connected.
2. Load the paper. For more information, see [Loading Paper](#).
3. Load your original document. For more information, see [Loading Original Documents](#).
4. *In Windows Vista™:*

- a. Click  **Programs**.
- b. Click **Dell Printers**.
- c. Click **Dell 968 AIO Printer**.

In Windows® XP or Windows 2000:

Click **Start® Programs** or **All Programs® Dell Printers® Dell 968 AIO Printer**.

5. Select **Dell All-In-One Center**.

The **Dell All-In-One Center** opens.





6. Select the number of copies (1–99), and then specify the color setting from the **Copy** drop-down menu.
 7. Click **See More Copy Settings** to customize your copy.
 8. After customizing your settings, click **Copy Now**.
-

Collating Copies



Using the Operator Panel

1. Turn on your printer.
2. Load the paper. For more information, see [Loading Paper](#).
3. Load your original document.



4. From the main menu, press the up **Arrow** button  to scroll to Copy, and then press the **Select** button.
5. Press the up or down **Arrow** button   to scroll to Copies, and then press the left or right **Arrow** button   to specify the number of copies (1–99).

 **NOTE:** You must make more than one copy before you can collate documents.

6. Press the up or down **Arrow** button   to scroll to Collate, and then press the left or right **Arrow** button   to scroll to On.
7. Press the **Select** button .
8. Press the **Start** button .

Using the Computer

1. Turn on your computer and printer, and make sure they are connected.
2. Load the paper. For more information, see [Loading Paper](#).
3. Load your original document.



4. *In Windows Vista:*
 - a. Click  **Programs**.
 - b. Click **Dell Printers**.
 - c. Click **Dell 968 AIO Printer**.

In Windows® XP or Windows 2000:

Click **Start® Programs** or **All Programs® Dell Printers® Dell 968 AIO Printer**.

5. Select **Dell All-In-One Center**.

The **Dell All-In-One Center** opens.

6. Select the number of copies (1–99), and then specify the color setting from the **Copy** drop-down menu.

 **NOTE:** You must make more than one copy before you can collate documents.

7. Click **See More Copy Settings** to customize your copy.
8. Click the **Advanced** button.

The **Advanced Copy Settings** dialog box opens.

9. On the **Print** tab, select the **Collate Copies** check box.
10. Click **OK**.
11. After customizing your settings, click **Copy Now**.





Copying Photos

Using the Operator Panel

1. Turn on the printer.

2. Load photo/glossy paper with the print side facing down. For more information, see [Loading Paper](#).
3. Load your original photo.



4. Press the up **Arrow** button  to scroll to Copy, and then press the **Select** button .
5. From the **Copy Mode** menu, press the up or down **Arrow** button  to scroll to Content Type.
6. Press the left or right **Arrow** button  to scroll to Photo.
7. Press the **Start** button .

Using Your Computer

1. Turn on your computer and printer, and make sure they are connected.
2. Load photo/glossy paper with the print side facing up. For more information, see [Loading Paper](#).
3. Load your original photo on the scanner glass. For more information, see [Loading Original Documents](#).

4. *In Windows Vista:*

- a. Click  **Programs**.
- b. Click **Dell Printers**.
- c. Click **Dell 968 AIO Printer**.

In Windows XP and Windows 2000:

Click **Start® Programs** or **All Programs® Dell Printers® Dell 968 AIO Printer**.

5. Select **Dell All-In-One Center**.

The **Dell All-In-One Center** opens.







6. Click **Preview Now**.
7. Adjust the dotted lines to fit around the portion of the image you want to print.
8. Select the number of copies (1–99), and then specify the color settings from the **Copy** drop-down menu.

9. Click **See More Copy Settings** to customize your copy.
 10. After customizing your settings, click **Copy Now**.
-

Copying a Two-Sided Document

1. Load the original document into the ADF.



2. From the main menu, press the up **Arrow** button  to scroll to Copy, and then press the **Select** button .
3. From the **Copy Mode** menu, press the up or down **Arrow** button  to scroll to 2-Sided Copies.
4. Press the left or right **Arrow** button  to scroll to 2-Sided Original, 1 Sided Copy (if you do not have the optional duplex unit) or 2-Sided Original, 2-Sided Copy (if you have the optional duplex unit), and then press the **Select** button .
5. Press the **Start** button .

When the original document exits from the ADF, follow the instructions on your LCD.



Making a Duplex Copy







Purchase and install an optional duplex unit to automatically perform duplex copies on your document. With an optional duplex unit, there is no need to manually re-orient the sheets. It picks the paper and allows the printer to print on the side that is still blank.

 **NOTE:** Use letter size or A4 plain paper for making duplex copies. Do *not* make duplex copies on envelopes, card stock, or photo paper.

1. Load the original document into the ADF.



2. From the main menu, press the up **Arrow** button  to scroll to Copy, and then press the **Select** button .

3. From the **Copy Mode** menu, press the up or down **Arrow** button   to scroll to 2-Sided Copies.
4. Press the left or right **Arrow** button   to scroll to 1-->2(1-Sided Original, 2-Sided Copy) (if you are copying a one-sided document) or 2-->2(2-Sided Original, 2-Sided Copy) (if you are copying a two-sided document), and then press the **Select** button .
5. Press the **Start** button .

Changing Copy Settings

Using the Operator Panel

If you are using your printer as a standalone copier, you can change the copy settings from the **Copy Mode** menus on the operator panel. For more information about settings, see [Copy Mode](#).

Using Your Computer

1. *In Windows Vista:*
 - a. Click  **Programs**.
 - b. Click **Dell Printers**.
 - c. Click **Dell 968 AIO Printer**.

In Windows XP and Windows 2000:

Click **Start**® **Programs** or **All Programs**® **Dell Printers**® **Dell 968 AIO Printer**.

2. Select **Dell All-In-One Center**.
The **Dell All-In-One Center** opens.
3. Select the number of copies (1–99) and color setting from the **Copy** drop-down menu.
4. Click **See More Copy Settings** to:
 - Choose a copy quality.
 - Select the paper size.
 - Select the original document size.
 - Lighten or darken your document.
 - Reduce or enlarge your document.
5. Click the **Advanced** button to change options such as paper size and quality.
6. To make any changes, click the following tabs:

Click this tab:	To:
Print	<ul style="list-style-type: none"> • Select the paper size and type.

	<p>Select borderless printing options.</p> <ul style="list-style-type: none"> • Select the print quality. • Collate copies. • Print the last page first.
Scan	<ul style="list-style-type: none"> • Select the color depth and scan resolution. • Auto-crop the scanned image. • Adjust the sensitivity of the auto-crop tool. • Set the size of the area to be scanned.
Image Enhancements	<ul style="list-style-type: none"> • Straighten images after scan (deskew). • Sharpen your blurry images. • Adjust the brightness of your image. • Adjust the color correction curve (gamma) of your image.
Image Patterns	<ul style="list-style-type: none"> • Smooth the conversion of a gray image to a black and white dot pattern. • Remove image patterns from magazines or newspapers (descreen). • Reduce the background noise on your color document.

7. Click **OK**.

8. After customizing your settings, click **Copy Now**.

Appendix

- [Dell Technical Support Policy](#)
 - [Contacting Dell](#)
 - [Warranty and Return Policy](#)
-

Dell Technical Support Policy

Technician-assisted technical support requires the cooperation and participation of the customer in the troubleshooting process and provides for restoration of the Operating System, application software and hardware drivers to the original default configuration as shipped from Dell, as well as the verification of appropriate functionality of the printer and all Dell-installed hardware. In addition to this technician assisted technical support, online technical support is available at Dell Support. Additional technical support options may be available for purchase.

Dell provides limited technical support for the printer and any Dell-installed software and peripherals. Support for third-party software and peripherals is provided by the original manufacturer, including those purchased and/or installed through Software & Peripherals (DellWare), ReadyWare, and Custom Factory Integration (CFI/DellPlus).

Contacting Dell

You can access Dell Support at support.dell.com. Select your region on the WELCOME TO DELL SUPPORT page, and fill in the requested details to access help tools and information.

You can contact Dell electronically using the following addresses:

- World Wide Web

www.dell.com/

www.dell.com/ap/ (Asian/Pacific countries only)

www.dell.com/jp/ (Japan only)

www.euro.dell.com (Europe only)

www.dell.com/la/ (Latin American and Caribbean countries)

www.dell.ca (Canada only)

- Anonymous file transfer protocol (FTP)

[ftp.dell.com](ftp://ftp.dell.com)

Log in as user: anonymous, and use your email address as your password.

- Electronic Support Service

mobile_support@us.dell.com

support@us.dell.com

la-techsupport@dell.com (Latin America and Caribbean countries only)

apsupport@dell.com (Asian/Pacific countries only)

support.jp.dell.com (Japan only)

support.euro.dell.com (Europe only)

- Electronic Quote Service

apmarketing@dell.com (Asian/Pacific countries only)

sales_canada@dell.com (Canada only)

Warranty and Return Policy

Dell Inc. ("Dell") manufactures its hardware products from parts and components that are new or equivalent to new in accordance with industry-standard practices. For information about the Dell warranty for your printer, refer to the Owner's Manual.

Scanning

- [Scanning Single-Page Documents or Photos](#)
 - [Scanning Multiple Photos Into a Single File](#)
 - [Scanning Multiple-Page Documents](#)
 - [Scanning Across a Network](#)
 - [Setting the Computer Name and PIN](#)
 - [Editing Scanned Text Using Optical Character Recognition \(OCR\)](#)
 - [Editing Scanned Images](#)
 - [Saving an Image on Your Computer](#)
 - [E-Mailing a Scanned Image or Document](#)
 - [Resizing Images or Documents](#)
 - [Cleaning up Scanned Copies of Newspaper Items](#)
 - [Converting Your Photo Collection to Electronic Format](#)
 - [Changing Scan Settings](#)
-

Scanning Single-Page Documents or Photos

1. Turn on your computer and printer, and make sure they are connected.
2. Load your original document. For more information, see [Loading Original Documents](#).
 - NOTE: Do not load postcards, photo cards, photo paper, or small images in the Automatic Document Feeder (ADF). Place these items on the scanner glass.
3. *In WindowsVista™:*
 - a. Click  **Programs**.
 - b. Click **Dell Printers**.
 - c. Click **Dell 968 AIO Printer**.

In Windows® XP or Windows 2000:

Click **Start® Programs** or **All Programs® Dell Printers® Dell 968 AIO Printer**.

4. Select **Dell All-In-One Center**.

The **Dell All-In-One Center** opens.
 5. From the **Send scanned image to:** drop-down menu, select the program you want to use.
 - NOTE: If the program you want to use is not listed, select **Search for more** in the drop-down menu. On the next screen, click **Add** to locate and add the program to the list.
 6. Click **See More Scan Settings** to customize your scan.
 7. After customizing your settings, click **Scan Now**.
-

Scanning Multiple Photos Into a Single File

- NOTE: Some programs do not support multiple-page scanning.

1. Turn on your computer and printer, and make sure they are connected.
2. Load your original document on the scanner glass. For more information, see [Loading Original Documents](#).
3. *In Windows Vista:*
 - a. Click  **Programs**.
 - b. Click **Dell Printers**.
 - c. Click **Dell 968 AIO Printer**.

In Windows XP and Windows 2000:

Click **Start**® **Programs** or **All Programs**® **Dell Printers**® **Dell 968 AIO Printer**.

4. Select **Dell All-In-One Center**.

The **Dell All-In-One Center** opens.

5. From the **Send scanned image to:** drop-down menu, select the program you want to use.

 **NOTE:** If the program you want to use is not listed, select **Search for more** in the drop-down menu. On the next screen, click **Add** to locate and add the program to the list.

6. Click **See More Scan Settings** to customize your scan.

7. Click the **Advanced** button.

The **Advanced Scan Settings** dialog box opens.

8. On the **Scan** tab, select the **Scan multiple items before output** check box.

9. Click **OK**.

10. After customizing your settings, click **Scan Now**.

After you scan the first page, a **Do you want to scan another page?** dialog box appears.

11. Place the next sheet on the scanner glass, and then click **Yes**. Repeat until you finish scanning all pages.

12. When the scanning is complete, click **No**.

When the printer completes scanning the last page or image, a single file containing all scanned pages or images is created in the selected application.

Scanning Multiple-Page Documents

 **NOTE:** Some programs do not support multiple-page scanning.

1. Turn on your computer and printer, and make sure they are connected.
2. Load your original document into the automatic document feeder.



3. *In Windows Vista:*

- a. Click  **Programs**.
- b. Click **Dell Printers**.
- c. Click **Dell 968 AIO Printer**.

In Windows XP and Windows 2000:

Click **Start**® **Programs** or **All Programs**® **Dell Printers**® **Dell 968 AIO Printer**.

4. Select **Dell All-In-One Center**.

The **Dell All-In-One Center** opens.

5. From the **Send scanned image to:** drop-down menu, select the program you want to use.

 **NOTE:** If the program you want to use is not listed, select **Search for more** in the drop-down menu. On the next screen, click **Add** to locate and add the program to the list.

6. Click **See More Scan Settings** to customize your scan.

7. After customizing your settings, click **Scan Now**.

The printer scans all pages loaded in the ADF. When all pages in the ADF are scanned, a single file containing all scanned pages is created in the selected application.

Scanning Across a Network

1. Turn on your computer and printer, and make sure they are connected.

2. Make sure your computer and printer are both attached to the network.

 **NOTE:** Dell™ printers can only be attached to a network using a Dell Network Adapter (sold separately).

3. Load your original document.

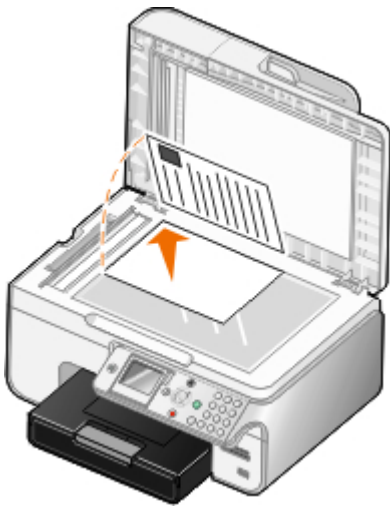

4. From the main menu, press the up or down **Arrow** button $\wedge \vee$ to scroll to Scan, and then press the **Select** button \checkmark .

The printer automatically detects if it is connected to a network. If it is connected to a network, the **Host Selection** screen appears. If it is not connected to a network, the **Scan Mode** menu appears.

5. From the **Host Selection** screen, choose the computer to which you want to send the document, and then press the **Select** button \checkmark .

 **NOTE:** The computer must have the printer software installed. Use the Drivers and Utilities CD to install the printer software.

6. Enter the four-digit PIN specified for the host computer, and then press the **Select** button \checkmark .

 **NOTE:** You can view or change the PIN or the name of the computer to which you want to send your scan. For more information, see [Setting the Computer Name and PIN](#). The PIN is not required by default; it is only requested if the PIN has been set.

The printer downloads a list of applications from your computer.

7. From Scan to, press the left or right **Arrow** button $\langle \rangle$ to choose an application to which to send your scan.
8. Make any necessary changes to your scan settings, and then press the **Start** button \rightarrow .

The scan opens on the computer you selected.

Setting the Computer Name and PIN

Specify a name for your computer to enable you to locate it on the Host Selection screen when scanning across a network. If you want to restrict users from sending a scanned document to your computer, set a scan-to-network Personal Identification Number (PIN).

1. *In Windows Vista:*
 - a. Click  **Control Panel**.
 - b. Click **Hardware and Sound**.

- c. Click **Printers**.

In Windows XP, click **Start**® **Settings**® **Control Panel**® **Printers and Other Hardware**® **Printers and Faxes**.

In Windows 2000, click **Start**® **Settings**® **Printers**.

2. Right-click your printer icon, and then click **Printing Preferences**.

The **Printing Preferences** dialog box opens.

3. From the **Maintenance** tab, click **Network Support**.

The **Dell Networking Options** dialog box opens.

4. From the **Dell Networking Options** dialog box, click **Change your PC name and PIN for network scanning**.
5. Follow the instructions on the screen.
6. After you specify a computer name or a PIN, click **OK**.

Editing Scanned Text Using Optical Character Recognition (OCR)

OCR software converts a scanned image to editable text within a word-processing program. A copy of OCR software was provided with your printer and should have been installed at the same time as your printer software.

- NOTE: If you downloaded your printer drivers and software from the Dell website, OCR software was not included.
- NOTE: For customers using Japanese or Simplified Chinese, ensure you have OCR software installed on your computer.

1. Turn on your computer and printer, and make sure they are connected.
2. Load your original document.



3. *In Windows Vista*:
 - a. Click **Programs**.
 - b. Click **Dell Printers**.
 - c. Click **Dell 968 AIO Printer**.

In Windows XP and Windows 2000:

Click **Start**® **Programs** or **All Programs**® **Dell Printers**® **Dell 968 AIO Printer**.

4. Select **Dell All-In-One Center**.

The **Dell All-In-One Center** opens.

5. From the **Send scanned images to:** drop-down menu, select the text-editing program you want to use.

 **NOTE:** If the program you want to use is not listed, select **Search for more** in the drop-down menu. On the next screen, click **Add** to locate and add your program to the list.

6. Click **See More Scan Settings** to customize your scan.

7. Click the **Advanced** button.

The **Advanced Scan Settings** dialog box opens.

8. On the **Scan** tab, ensure the **Convert scanned item to text (OCR)** check box is selected.

9. Click **OK**.

10. When you finish customizing your settings, click **Scan Now**.

The scanned text opens in the program you selected.

Editing Scanned Images

1. Turn on your computer and printer, and make sure they are connected.
2. Load your original document. For more information, see [Loading Original Documents](#).
3. *In Windows Vista:*

- a. Click  **Programs**.
- b. Click **Dell Printers**.
- c. Click **Dell 968 AIO Printer**.

In Windows XP and Windows 2000:

Click **Start® Programs** or **All Programs® Dell Printers® Dell 968 AIO Printer**.

4. Select **Dell All-In-One Center**.

The **Dell All-In-One Center** opens.

5. From the **Send scanned image to:** drop-down menu, select the program you want to use.

 **NOTE:** If the program you want to use is not listed, select **Search for more** in the drop-down menu. On the next screen, click **Add** to locate and add your program to the list.

6. Click **See More Scan Settings** to customize your scan.

7. After customizing your settings, click **Scan Now**.

When the image has finished processing, it opens in the program you selected.

8. Edit the image using the tools available in your program. You may be able to:

- Remove red eye
- Crop your image
- Add text to your image
- Adjust the brightness and contrast of your image

For more information, see the documentation that came with your graphics program.

Saving an Image on Your Computer

1. Turn on your computer and printer, and make sure they are connected.
2. Load your original document. For more information, see [Loading Original Documents](#).
3. *In Windows Vista:*
 - a. Click  **Programs**.
 - b. Click **Dell Printers**.
 - c. Click **Dell 968 AIO Printer**.

In Windows XP and Windows 2000:

Click **Start**® **Programs** or **All Programs**® **Dell Printers**® **Dell 968 AIO Printer**.

4. Select **Dell All-In-One Center**.

The **Dell All-In-One Center** opens.
 5. From the **Productivity Tools** section, click **Save an image on my computer**.
 6. Follow the instructions on your screen to save an image on your computer.
-

E-Mailing a Scanned Image or Document

 **NOTE:** If your printer is connected to a network using a wireless or Ethernet connection, you must start your scan from the printer operator panel. For more information, see [From a Networked Printer](#).

1. Turn on your computer and printer, and make sure they are connected.
2. Load your original document. For more information, see [Loading Original Documents](#).
3. *In Windows Vista:*
 - a. Click  **Programs**.
 - b. Click **Dell Printers**.
 - c. Click **Dell 968 AIO Printer**.

In Windows XP and Windows 2000:

Click **Start® Programs** or **All Programs® Dell Printers® Dell 968 AIO Printer**.





4. Select **Dell All-In-One Center**.

The **Dell All-In-One Center** opens.

5. From the **Productivity Tools** section, click **E-mail an image or document**.
6. Follow the instructions on the screen to prepare the document for e-mail.
7. Click **Next**.
8. Open your e-mail program, write a note to accompany the attached document, and then send it.

 **NOTE:** See Help in your e-mail program for more information on attaching documents to your e-mail.

From a Networked Printer



1. Turn on your computer and printer, and make sure they are connected.
2. Make sure your computer and printer are both attached to the network.
 **NOTE:** Dell printers can only be attached to a network using a Dell Network Adapter (sold separately).
3. Load your original document. For more information, see [Loading Original Documents](#).
4. From the printer operator panel, press the up or down **Arrow** button   to scroll to Scan, and then press the **Select** button .
5. From the **Host Selection** screen, choose the computer to which you want to send the document, and then press the **Select** button .

 **NOTE:** The computer must have the printer software installed. Use the Drivers and Utilities CD to install the printer software.

6. If necessary, enter the four-digit PIN specified for the host computer, and then press the **Select** button .

 **NOTE:** You can view or change the PIN or the name of the computer to which you want to send your scan. For more information, see [Setting the Computer Name and PIN](#). The PIN is not required by default; it is only requested if the PIN has been set.

The printer downloads a list of applications from your computer.

7. From Scan to, press the left or right **Arrow** button   to scroll to Email.
8. Make any necessary changes to your scan settings, and then press the **Start** button .

The printer attaches your scan to a new e-mail message in your default e-mail application. Write a note to accompany the attached document, and then send it.

Resizing Images or Documents

1. Turn on your computer and printer, and make sure they are connected.

2. Load your original document. For more information, see [Loading Original Documents](#).

3. *In Windows Vista:*

a. Click  **Programs**.

b. Click **Dell Printers**.

c. Click **Dell 968 AIO Printer**.

In Windows XP and Windows 2000:

Click **Start**® **Programs** or **All Programs**® **Dell Printers**® **Dell 968 AIO Printer**.

4. Select **Dell All-In-One Center**.

The **Dell All-In-One Center** opens.

5. Click **Preview Now**.

 **NOTE:** If the size of the scan (found in the upper right corner of the preview window) appears in red, you do not have the system resources available to perform the scan at the resolution or size you have selected. To correct this problem, you can either reduce the resolution or the size of your scan area.

6. From the **Productivity Tools** section, select **Enlarge or reduce an image**.

7. Follow the instructions on the screen to select the size of your new image.

8. After customizing your image, click **Scan Now**.

Cleaning up Scanned Copies of Newspaper Items

1. Turn on your computer and printer, and make sure they are connected.

2. Lay the newspaper article or clipping face down onto the scanner glass.

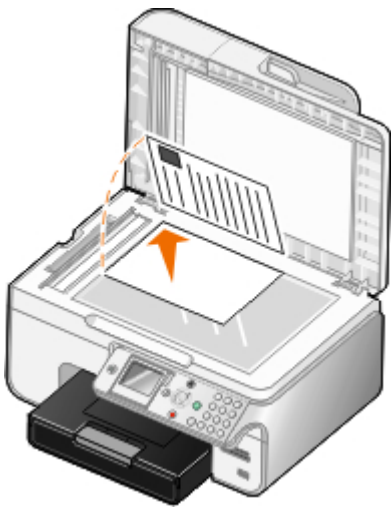

3. *In Windows Vista:*

a. Click  **Programs**.

b. Click **Dell Printers**.

- c. Click **Dell 968 AIO Printer**.

In Windows XP and Windows 2000:

Click **Start® Programs** or **All Programs® Dell Printers® Dell 968 AIO Printer**.

4. Click **Dell All-In-One Center**.

The **Dell All-In-One Center** opens.

5. Click **See More Scan Settings** or **See More Copy Settings**.

6. Click **Advanced**.

The **Advanced Scan Settings** dialog box opens.

7. On the **Image Patterns** tab, click **Remove image patterns from magazine/newspaper (descreen)**.

8. Select the **Best Quality** or the **Best Speed** option.

9. In the **What was scanned?** drop-down menu, select the type of item you scanned or copied.

10. Click **OK** to save the settings.

11. Scan or copy the item.

Converting Your Photo Collection to Electronic Format

1. Turn on your computer and printer, and make sure they are connected.

2. *In Windows Vista:*

- a. Click  **Programs**.

- b. Click **Dell Printers**.

- c. Click **Dell 968 AIO Printer**.

In Windows XP and Windows 2000:

Click **Start® Programs** or **All Programs® Dell Printers® Dell 968 AIO Printer**.

3. Click **Dell All-In-One Center**.

The **Dell All-In-One Center** opens.

4. From the **Productivity Tools** section, click **MagiChop - Save multiple photos**.

5. Place the photos on the scanner glass, spacing them from each other and from the edge of the glass.

6. Click **Preview the image (required)**.

7. Choose the file location of the images.

8. If you want rotate and renaming options to be available after scanning, select **While saving, provide rotate and rename options**.

9. Click **Scan Now**.

Changing Scan Settings

Using the Operator Panel

You can change the copy settings from the **Scan Mode** menu on the operator panel. For more information about settings, see [Scan Mode](#).

Using Your Computer

1. *In Windows Vista:*

- a. Click  **Programs**.
- b. Click **Dell Printers**.
- c. Click **Dell 968 AIO Printer**.

In Windows XP and Windows 2000:

Click **Start**® **Programs** or **All Programs**® **Dell Printers**® **Dell 968 AIO Printer**.

2. Select **Dell All-In-One Center**.

The **Dell All-In-One Center** opens.

3. From the **Send scanned images to:** drop down menu, select the program you want to use.

 **NOTE:** If the program you want to use is not listed, select **Search for more** in the drop-down menu. On the next screen, click **Add** to locate and add the program to the list.

4. Click **See More Scan Settings** to:

- Select what kind of document is being scanned.
- Select a scan quality.

5. Click the **Advanced** button to change options such as paper size and quality.

6. To make any changes, click the following tabs:

Click this tab:	To:
Scan	<ul style="list-style-type: none">• Choose a color depth.• Select a scan resolution.• Adjust the sensitivity of the auto-crop tool.• Set the area to be scanned.• Use the OCR program to convert scanned items to text.• Indicate that you are scanning multiple items.

	<ul style="list-style-type: none">• Update the list of applications to send scans to.• Update the default fax driver.
Image Enhancements	<ul style="list-style-type: none">• Straighten images after scan (deskew).• Sharpen your blurry images.• Adjust the brightness of your image.• Adjust the color correction curve (gamma) of your image.
Image Patterns	<ul style="list-style-type: none">• Smooth the conversion of a gray image to a black-and-white dot pattern.• Remove image patterns from magazines or newspapers (descreen).• Reduce the background noise on your color document.

7. Click **OK**.

8. After customizing your settings, click **Scan Now**.

Licensing Notice

• [BSD License and Warranty statements](#)

• [GNU License](#)

For additional open source license agreements on this CD, see D:\Drivers\XPS\Zopen.pdf.

The printer resident software contains:

- Software developed and copyrighted by Dell and/or third parties
- Dell modified software licensed under the provisions of the GNU General Public License version 2 and the GNU Lesser General Public License version 2.1
- Software licensed under the BSD license and warranty statements
- Software based in part on the work of the Independent JPEG Group.

The Dell modified GNU licensed software is free software; you can redistribute it and/or modify it under the terms of the licenses referenced above. These licenses do not provide you any rights to the Dell- or third-party-copyrighted software in this printer.

Since the GNU licensed software that the Dell modifications are based upon is supplied explicitly without warranty, use of the Dell modified version is similarly provided without warranty. See the warranty disclaimers in the referenced licenses for additional details.

BSD License and Warranty statements

Copyright (c) 1991 The Regents of the University of California. All rights reserved.

Redistribution and use in source and binary forms, with or without modification, are permitted provided that the following conditions are met:

1. Redistributions of source code must retain the above copyright notice, this list of conditions and the following disclaimer.
2. Redistributions in binary form must reproduce the above copyright notice, this list of conditions and the following disclaimer in the documentation and/or other materials provided with the distribution.
3. The name of the author may not be used to endorse or promote products derived from this software without specific prior written permission.

THIS SOFTWARE IS PROVIDED BY THE AUTHOR ``AS IS'' AND ANY EXPRESS OR IMPLIED WARRANTIES, INCLUDING, BUT NOT LIMITED TO, THE IMPLIED WARRANTIES OF MERCHANTABILITY AND FITNESS FOR A PARTICULAR PURPOSE ARE DISCLAIMED. IN NO EVENT SHALL THE AUTHOR BE LIABLE FOR ANY DIRECT, INDIRECT, INCIDENTAL, SPECIAL, EXEMPLARY, OR CONSEQUENTIAL DAMAGES (INCLUDING, BUT NOT LIMITED TO, PROCUREMENT OF SUBSTITUTE GOODS OR SERVICES; LOSS OF USE, DATA, OR PROFITS; OR BUSINESS INTERRUPTION) HOWEVER CAUSED AND ON ANY THEORY OF LIABILITY, WHETHER IN CONTRACT, STRICT LIABILITY, OR TORT (INCLUDING NEGLIGENCE OR OTHERWISE) ARISING IN ANY WAY OUT OF THE USE OF THIS SOFTWARE, EVEN IF ADVISED OF THE POSSIBILITY OF SUCH DAMAGE.

GNU License

GENERAL PUBLIC LICENSE

Version 2, June 1991

Copyright (C) 1989, 1991 Free Software Foundation, Inc.

59 Temple Place, Suite 330, Boston, MA 02111-1307 USA

Everyone is permitted to copy and distribute verbatim copies of this license document, but changing it is not allowed.

Preamble

The licenses for most software are designed to take away your freedom to share and change it. By contrast, the GNU General Public License is intended to guarantee your freedom to share and change free software--to make sure the software is free for all its users. This General Public License applies to most of the Free Software Foundation's software and to any other program whose authors commit to using it. (Some other Free Software Foundation software is covered by the GNU Library General Public License instead.) You can apply it to your programs, too.

When we speak of free software, we are referring to freedom, not price. Our General Public Licenses are designed to make sure that you have the freedom to distribute copies of free software (and charge for this service if you wish), that you receive source code or can get it if you want it, that you can change the software or use pieces of it in new free programs; and that you know you can do these things.

To protect your rights, we need to make restrictions that forbid anyone to deny you these rights or to ask you to surrender the rights. These restrictions translate to certain responsibilities for you if you distribute copies of the software, or if you modify it.

For example, if you distribute copies of such a program, whether gratis or for a fee, you must give the recipients all the rights that you have. You must make sure that they, too, receive or can get the source code. And you must show them these terms so they know their rights.

We protect your rights with two steps: (1) copyright the software, and (2) offer you this license which gives you legal permission to copy, distribute and/or modify the software.

Also, for each author's protection and ours, we want to make certain that everyone understands that there is no warranty for this free software. If the software is modified by someone else and passed on, we want its recipients to know that what they have is not the original, so that any problems introduced by others will not reflect on the original authors' reputations.

Finally, any free program is threatened constantly by software patents. We wish to avoid the danger that redistributors of a free program will individually obtain patent licenses, in effect making the program proprietary. To prevent this, we have made it clear that any patent must be licensed for everyone's free use or not licensed at all.

The precise terms and conditions for copying, distribution and modification follow.

GNU GENERAL PUBLIC LICENSE

TERMS AND CONDITIONS FOR COPYING, DISTRIBUTION AND MODIFICATION

0. This License applies to any program or other work which contains a notice placed by the copyright holder saying it may be distributed under the terms of this General Public License. The "Program", below, refers to any such program or work, and a "work based on the Program" means either the Program or any derivative work under copyright law: that is to say, a work containing the Program or a portion of it, either verbatim or with modifications and/or translated into another language. (Hereinafter, translation is included without limitation in the term "modification".) Each licensee is addressed as "you". Activities other than copying, distribution and modification are not covered by this License; they are

outside its scope. The act of running the Program is not restricted, and the output from the Program is covered only if its contents constitute a work based on the Program (independent of having been made by running the Program). Whether that is true depends on what the Program does.

1. You may copy and distribute verbatim copies of the Program's source code as you receive it, in any medium, provided that you conspicuously and appropriately publish on each copy an appropriate copyright notice and disclaimer of warranty; keep intact all the notices that refer to this License and to the absence of any warranty; and give any other recipients of the Program a copy of this License along with the Program.

You may charge a fee for the physical act of transferring a copy, and you may at your option offer warranty protection in exchange for a fee.

2. You may modify your copy or copies of the Program or any portion of it, thus forming a work based on the Program, and copy and distribute such modifications or work under the terms of Section 1 above, provided that you also meet all of these conditions:

a. You must cause the modified files to carry prominent notices stating that you changed the files and the date of any change.

b. You must cause any work that you distribute or publish, that in whole or in part contains or is derived from the Program or any part thereof, to be licensed as a whole at no charge to all third parties under the terms of this License.

c. If the modified program normally reads commands interactively when run, you must cause it, when started running for such interactive use in the most ordinary way, to print or display an announcement including an appropriate copyright notice and a notice that there is no warranty (or else, saying that you provide a warranty) and that users may redistribute the program under these conditions, and telling the user how to view a copy of this License. (Exception: if the Program itself is interactive but does not normally print such an announcement, your work based on the Program is not required to print an announcement.)

These requirements apply to the modified work as a whole. If identifiable sections of that work are not derived from the Program, and can be reasonably considered independent and separate works in themselves, then this License, and its terms, do not apply to those sections when you distribute them as separate works. But when you distribute the same sections as part of a whole which is a work based on the Program, the distribution of the whole must be on the terms of this License, whose permissions for other licensees extend to the entire whole, and thus to each and every part regardless of who wrote it.

Thus, it is not the intent of this section to claim rights or contest your rights to work written entirely by you; rather, the intent is to exercise the right to control the distribution of derivative or collective works based on the Program.

In addition, mere aggregation of another work not based on the Program with the Program (or with a work based on the Program) on a volume of a storage or distribution medium does not bring the other work under the scope of this License.

3. You may copy and distribute the Program (or a work based on it, under Section 2) in object code or executable form under the terms of Sections 1 and 2 above provided that you also do one of the following:

a. Accompany it with the complete corresponding machine-readable source code, which must be distributed under the terms of Sections 1 and 2 above on a medium customarily used for software interchange; or,

b. Accompany it with a written offer, valid for at least three years, to give any third party, for a charge no more than your cost of physically performing source distribution, a complete machine-readable copy of the corresponding source code, to be distributed under the terms of Sections 1 and 2 above on a medium customarily used for software interchange; or,

c. Accompany it with the information you received as to the offer to distribute corresponding source

code. (This alternative is allowed only for noncommercial distribution and only if you received the program in object code or executable form with such an offer, in accord with Subsection b above.)

The source code for a work means the preferred form of the work for making modifications to it. For an executable work, complete source code means all the source code for all modules it contains, plus any associated interface definition files, plus the scripts used to control compilation and installation of the executable. However, as a special exception, the source code distributed need not include anything that is normally distributed (in either source or binary form) with the major components (compiler, kernel, and so on) of the operating system on which the executable runs, unless that component itself accompanies the executable.

If distribution of executable or object code is made by offering access to copy from a designated place, then offering equivalent access to copy the source code from the same place counts as distribution of the source code, even though third parties are not compelled to copy the source along with the object code.

4. You may not copy, modify, sublicense, or distribute the Program except as expressly provided under this License. Any attempt otherwise to copy, modify, sublicense or distribute the Program is void, and will automatically terminate your rights under this License. However, parties who have received copies, or rights, from you under this License will not have their licenses terminated so long as such parties remain in full compliance.

5. You are not required to accept this License, since you have not signed it. However, nothing else grants you permission to modify or distribute the Program or its derivative works. These actions are prohibited by law if you do not accept this License. Therefore, by modifying or distributing the Program (or any work based on the Program), you indicate your acceptance of this License to do so, and all its terms and conditions for copying, distributing or modifying the Program or works based on it.

6. Each time you redistribute the Program (or any work based on the Program), the recipient automatically receives a license from the original licensor to copy, distribute or modify the Program subject to these terms and conditions. You may not impose any further restrictions on the recipients' exercise of the rights granted herein. You are not responsible for enforcing compliance by third parties to this License.

7. If, as a consequence of a court judgment or allegation of patent infringement or for any other reason (not limited to patent issues), conditions are imposed on you (whether by court order, agreement or otherwise) that contradict the conditions of this License, they do not excuse you from the conditions of this License. If you cannot distribute so as to satisfy simultaneously your obligations under this License and any other pertinent obligations, then as a consequence you may not distribute the Program at all. For example, if a patent license would not permit royalty-free redistribution of the Program by all those who receive copies directly or indirectly through you, then the only way you could satisfy both it and this License would be to refrain entirely from distribution of the Program.

If any portion of this section is held invalid or unenforceable under any particular circumstance, the balance of the section is intended to apply and the section as a whole is intended to apply in other circumstances.

It is not the purpose of this section to induce you to infringe any patents or other property right claims or to contest validity of any such claims; this section has the sole purpose of protecting the integrity of the free software distribution system, which is implemented by public license practices. Many people have made generous contributions to the wide range of software distributed through that system in reliance on consistent application of that system; it is up to the author/donor to decide if he or she is willing to distribute software through any other system and a licensee cannot impose that choice.

This section is intended to make thoroughly clear what is believed to be a consequence of the rest of this License.

8. If the distribution and/or use of the Program is restricted in certain countries either by patents or by copyrighted interfaces, the original copyright holder who places the Program under this License may add an explicit geographical distribution limitation excluding those countries, so that distribution is permitted only in or among countries not thus excluded. In such case, this License incorporates the limitation as if

written in the body of this License.

9. The Free Software Foundation may publish revised and/or new versions of the General Public License from time to time. Such new versions will be similar in spirit to the present version, but may differ in detail to address new problems or concerns.

Each version is given a distinguishing version number. If the Program specifies a version number of this License which applies to it and "any later version", you have the option of following the terms and conditions either of that version or of any later version published by the Free Software Foundation. If the Program does not specify a version number of this License, you may choose any version ever published by the Free Software Foundation.

10. If you wish to incorporate parts of the Program into other free programs whose distribution conditions are different, write to the author to ask for permission. For software which is copyrighted by the Free Software Foundation, write to the Free Software Foundation; we sometimes make exceptions for this. Our decision will be guided by the two goals of preserving the free status of all derivatives of our free software and of promoting the sharing and reuse of software generally.

NO WARRANTY

11. BECAUSE THE PROGRAM IS LICENSED FREE OF CHARGE, THERE IS NO WARRANTY FOR THE PROGRAM, TO THE EXTENT PERMITTED BY APPLICABLE LAW. EXCEPT WHEN OTHERWISE STATED IN WRITING THE COPYRIGHT HOLDERS AND/OR OTHER PARTIES PROVIDE THE PROGRAM "AS IS" WITHOUT WARRANTY OF ANY KIND, EITHER EXPRESSED OR IMPLIED, INCLUDING, BUT NOT LIMITED TO, THE IMPLIED WARRANTIES OF MERCHANTABILITY AND FITNESS FOR A PARTICULAR PURPOSE. THE ENTIRE RISK AS TO THE QUALITY AND PERFORMANCE OF THE PROGRAM IS WITH YOU. SHOULD THE PROGRAM PROVE DEFECTIVE, YOU ASSUME THE COST OF ALL NECESSARY SERVICING, REPAIR OR CORRECTION.

12. IN NO EVENT UNLESS REQUIRED BY APPLICABLE LAW OR AGREED TO IN WRITING WILL ANY COPYRIGHT HOLDER, OR ANY OTHER PARTY WHO MAY MODIFY AND/OR REDISTRIBUTE THE PROGRAM AS PERMITTED ABOVE, BE LIABLE TO YOU FOR DAMAGES, INCLUDING ANY GENERAL, SPECIAL, INCIDENTAL OR CONSEQUENTIAL DAMAGES ARISING OUT OF THE USE OR INABILITY TO USE THE PROGRAM (INCLUDING BUT NOT LIMITED TO LOSS OF DATA OR DATA BEING RENDERED INACCURATE OR LOSSES SUSTAINED BY YOU OR THIRD PARTIES OR A FAILURE OF THE PROGRAM TO OPERATE WITH ANY OTHER PROGRAMS), EVEN IF SUCH HOLDER OR OTHER PARTY HAS BEEN ADVISED OF THE POSSIBILITY OF SUCH DAMAGES.

END OF TERMS AND CONDITIONS

How to Apply These Terms to Your New Programs

If you develop a new program, and you want it to be of the greatest possible use to the public, the best way to achieve this is to make it free software which everyone can redistribute and change under these terms.

To do so, attach the following notices to the program. It is safest to attach them to the start of each source file to most effectively convey the exclusion of warranty; and each file should have at least the "copyright" line and a pointer to where the full notice is found.

1 April 1989

Lexmark International, Inc.

This General Public License does not permit incorporating your program into proprietary programs. If your program is a subroutine library, you may consider it more useful to permit linking proprietary applications with the library. If this is what you want to do, use the GNU Library General Public License instead of this License.

GNU LESSER GENERAL PUBLIC LICENSE

Version 2.1, February 1999

Copyright (C) 1991, 1999 Free Software Foundation, Inc.

59 Temple Place, Suite 330, Boston, MA 02111-1307 USA

Everyone is permitted to copy and distribute verbatim copies of this license document, but changing it is not allowed.

[This is the first released version of the Lesser GPL. It also counts as the successor of the GNU Library Public License, version 2, hence the version number 2.1.]

Preamble

The licenses for most software are designed to take away your freedom to share and change it. By contrast, the GNU General Public Licenses are intended to guarantee your freedom to share and change free software--to make sure the software is free for all its users.

This license, the Lesser General Public License, applies to some specially designated software packages--typically libraries--of the Free Software Foundation and other authors who decide to use it. You can use it too, but we suggest you first think carefully about whether this license or the ordinary General Public License is the better strategy to use in any particular case, based on the explanations below.

When we speak of free software, we are referring to freedom of use, not price. Our General Public Licenses are designed to make sure that you have the freedom to distribute copies of free software (and charge for this service if you wish); that you receive source code or can get it if you want it; that you can change the software and use pieces of it in new free programs; and that you are informed that you can do these things.

To protect your rights, we need to make restrictions that forbid distributors to deny you these rights or to ask you to surrender these rights. These restrictions translate to certain responsibilities for you if you distribute copies of the library or if you modify it.

For example, if you distribute copies of the library, whether gratis or for a fee, you must give the recipients all the rights that we gave you. You must make sure that they, too, receive or can get the source code. If you link other code with the library, you must provide complete object files to the recipients, so that they can relink them with the library after making changes to the library and recompiling it. And you must show them these terms so they know their rights.

We protect your rights with a two-step method: (1) we copyright the library, and (2) we offer you this license, which gives you legal permission to copy, distribute and/or modify the library.

To protect each distributor, we want to make it very clear that there is no warranty for the free library. Also, if the library is modified by someone else and passed on, the recipients should know that what they have is not the original version, so that the original author's reputation will not be affected by problems that might be introduced by others.

Finally, software patents pose a constant threat to the existence of any free program. We wish to make sure that a company cannot effectively restrict the users of a free program by obtaining a restrictive license from a patent holder. Therefore, we insist that any patent license obtained for a version of the library must be consistent with the full freedom of use specified in this license.

Most GNU software, including some libraries, is covered by the ordinary GNU General Public License. This license, the GNU Lesser General Public License, applies to certain designated libraries, and is quite different from the ordinary General Public License. We use this license for certain libraries in order to permit linking those libraries into non-free programs.

When a program is linked with a library, whether statically or using a shared library, the combination of the two is legally speaking a combined work, a derivative of the original library. The ordinary General Public License therefore permits such linking only if the entire combination fits its criteria of freedom. The Lesser General Public License permits more lax criteria for linking other code with the library.

We call this license the "Lesser" General Public License because it does Less to protect the user's

freedom than the ordinary General Public License. It also provides other free software developers Less of an advantage over competing non-free programs. These disadvantages are the reason we use the ordinary General Public License for many libraries. However, the Lesser license provides advantages in certain special circumstances.

For example, on rare occasions, there may be a special need to encourage the widest possible use of a certain library, so that it becomes a de-facto standard. To achieve this, non-free programs must be allowed to use the library. A more frequent case is that a free library does the same job as widely used non-free libraries. In this case, there is little to gain by limiting the free library to free software only, so we use the Lesser General Public License.

In other cases, permission to use a particular library in non-free programs enables a greater number of people to use a large body of free software. For example, permission to use the GNU C Library in non-free programs enables many more people to use the whole GNU operating system, as well as its variant, the GNU/Linux operating system.

Although the Lesser General Public License is Less protective of the users' freedom, it does ensure that the user of a program that is linked with the Library has the freedom and the wherewithal to run that program using a modified version of the Library.

The precise terms and conditions for copying, distribution and modification follow. Pay close attention to the difference between a "work based on the library" and a "work that uses the library". The former contains code derived from the library, whereas the latter must be combined with the library in order to run.

GNU LESSER GENERAL PUBLIC LICENSE

TERMS AND CONDITIONS FOR COPYING, DISTRIBUTION AND MODIFICATION

0. This License Agreement applies to any software library or other program which contains a notice placed by the copyright holder or other authorized party saying it may be distributed under the terms of this Lesser General Public License (also called "this License"). Each licensee is addressed as "you".

A "library" means a collection of software functions and/or data prepared so as to be conveniently linked with application programs (which use some of those functions and data) to form executables.

The "Library", below, refers to any such software library or work which has been distributed under these terms. A "work based on the Library" means either the Library or any derivative work under copyright law: that is to say, a work containing the Library or a portion of it, either verbatim or with modifications and/or translated straightforwardly into another language. (Hereinafter, translation is included without limitation in the term "modification".)

"Source code" for a work means the preferred form of the work for making modifications to it. For a library, complete source code means all the source code for all modules it contains, plus any associated interface definition files, plus the scripts used to control compilation and installation of the library.

Activities other than copying, distribution and modification are not covered by this License; they are outside its scope. The act of running a program using the Library is not restricted, and output from such a program is covered only if its contents constitute a work based on the Library (independent of the use of the Library in a tool for writing it). Whether that is true depends on what the Library does and what the program that uses the Library does.

1. You may copy and distribute verbatim copies of the Library's complete source code as you receive it, in any medium, provided that you conspicuously and appropriately publish on each copy an appropriate copyright notice and disclaimer of warranty; keep intact all the notices that refer to this License and to the absence of any warranty; and distribute a copy of this License along with the Library.

You may charge a fee for the physical act of transferring a copy, and you may at your option offer warranty protection in exchange for a fee.

2. You may modify your copy or copies of the Library or any portion of it, thus forming a work based on

the Library, and copy and distribute such modifications or work under the terms of Section 1 above, provided that you also meet all of these conditions:

- a. The modified work must itself be a software library.
- b. You must cause the files modified to carry prominent notices stating that you changed the files and the date of any change.
- c. You must cause the whole of the work to be licensed at no charge to all third parties under the terms of this License.
- d. If a facility in the modified Library refers to a function or a table of data to be supplied by an application program that uses the facility, other than as an argument passed when the facility is invoked, then you must make a good faith effort to ensure that, in the event an application does not supply such function or table, the facility still operates, and performs whatever part of its purpose remains meaningful.

(For example, a function in a library to compute square roots has a purpose that is entirely well-defined independent of the application. Therefore, Subsection 2d requires that any application-supplied function or table used by this function must be optional: if the application does not supply it, the square root function must still compute square roots.)

These requirements apply to the modified work as a whole. If identifiable sections of that work are not derived from the Library, and can be reasonably considered independent and separate works in themselves, then this License, and its terms, do not apply to those sections when you distribute them as separate works. But when you distribute the same sections as part of a whole which is a work based on the Library, the distribution of the whole must be on the terms of this License, whose permissions for other licensees extend to the entire whole, and thus to each and every part regardless of who wrote it.

Thus, it is not the intent of this section to claim rights or contest your rights to work written entirely by you; rather, the intent is to exercise the right to control the distribution of derivative or collective works based on the Library.

In addition, mere aggregation of another work not based on the Library with the Library (or with a work based on the Library) on a volume of a storage or distribution medium does not bring the other work under the scope of this License.

3. You may opt to apply the terms of the ordinary GNU General Public License instead of this License to a given copy of the Library. To do this, you must alter all the notices that refer to this License, so that they refer to the ordinary GNU General Public License, version 2, instead of to this License. (If a newer version than version 2 of the ordinary GNU General Public License has appeared, then you can specify that version instead if you wish.) Do not make any other change in these notices.

Once this change is made in a given copy, it is irreversible for that copy, so the ordinary GNU General Public License applies to all subsequent copies and derivative works made from that copy.

This option is useful when you wish to copy part of the code of the Library into a program that is not a library.

4. You may copy and distribute the Library (or a portion or derivative of it, under Section 2) in object code or executable form under the terms of Sections 1 and 2 above provided that you accompany it with the complete corresponding machine-readable source code, which must be distributed under the terms of Sections 1 and 2 above on a medium customarily used for software interchange.

If distribution of object code is made by offering access to copy from a designated place, then offering equivalent access to copy the source code from the same place satisfies the requirement to distribute the source code, even though third parties are not compelled to copy the source along with the object code.

5. A program that contains no derivative of any portion of the Library, but is designed to work with the Library by being compiled or linked with it, is called a "work that uses the Library". Such a work, in

isolation, is not a derivative work of the Library, and therefore falls outside the scope of this License.

However, linking a "work that uses the Library" with the Library creates an executable that is a derivative of the Library (because it contains portions of the Library), rather than a "work that uses the library". The executable is therefore covered by this License. Section 6 states terms for distribution of such executables.

When a "work that uses the Library" uses material from a header file that is part of the Library, the object code for the work may be a derivative work of the Library even though the source code is not. Whether this is true is especially significant if the work can be linked without the Library, or if the work is itself a library. The threshold for this to be true is not precisely defined by law.

If such an object file uses only numerical parameters, data structure layouts and accessors, and small macros and small inline functions (ten lines or less in length), then the use of the object file is unrestricted, regardless of whether it is legally a derivative work. (Executables containing this object code plus portions of the Library will still fall under Section 6.)

Otherwise, if the work is a derivative of the Library, you may distribute the object code for the work under the terms of Section 6. Any executables containing that work also fall under Section 6, whether or not they are linked directly with the Library itself.

6. As an exception to the Sections above, you may also combine or link a "work that uses the Library" with the Library to produce a work containing portions of the Library, and distribute that work under terms of your choice, provided that the terms permit modification of the work for the customer's own use and reverse engineering for debugging such modifications.

You must give prominent notice with each copy of the work that the Library is used in it and that the Library and its use are covered by this License. You must supply a copy of this License. If the work during execution displays copyright notices, you must include the copyright notice for the Library among them, as well as a reference directing the user to the copy of this License. Also, you must do one of these things:

- a. Accompany the work with the complete corresponding machine-readable source code for the Library including whatever changes were used in the work (which must be distributed under Sections 1 and 2 above); and, if the work is an executable linked with the Library, with the complete machine-readable "work that uses the Library", as object code and/or source code, so that the user can modify the Library and then relink to produce a modified executable containing the modified Library. (It is understood that the user who changes the contents of definitions files in the Library will not necessarily be able to recompile the application to use the modified definitions.)
- b. Use a suitable shared library mechanism for linking with the Library. A suitable mechanism is one that (1) uses at run time a copy of the library already present on the user's computer system, rather than copying library functions into the executable, and (2) will operate properly with a modified version of the library, if the user installs one, as long as the modified version is interface-compatible with the version that the work was made with.
- c. Accompany the work with a written offer, valid for at least three years, to give the same user the materials specified in Subsection 6a, above, for a charge no more than the cost of performing this distribution.
- d. If distribution of the work is made by offering access to copy from a designated place, offer equivalent access to copy the above specified materials from the same place.
- e. Verify that the user has already received a copy of these materials or that you have already sent this user a copy.

For an executable, the required form of the "work that uses the Library" must include any data and utility programs needed for reproducing the executable from it. However, as a special exception, the materials to be distributed need not include anything that is normally distributed (in either source or binary form) with the major components (compiler, kernel, and so on) of the operating system on which the executable runs, unless that component itself accompanies the executable.

It may happen that this requirement contradicts the license restrictions of other proprietary libraries that do not normally accompany the operating system. Such a contradiction means you cannot use both them and the Library together in an executable that you distribute.

7. You may place library facilities that are a work based on the Library side-by-side in a single library together with other library facilities not covered by this License, and distribute such a combined library, provided that the separate distribution of the work based on the Library and of the other library facilities is otherwise permitted, and provided that you do these two things:

a. Accompany the combined library with a copy of the same work based on the Library, uncombined with any other library facilities. This must be distributed under the terms of the Sections above.

b. Give prominent notice with the combined library of the fact that part of it is a work based on the Library, and explaining where to find the accompanying uncombined form of the same work.

8. You may not copy, modify, sublicense, link with, or distribute the Library except as expressly provided under this License. Any attempt otherwise to copy, modify, sublicense, link with, or distribute the Library is void, and will automatically terminate your rights under this License. However, parties who have received copies, or rights, from you under this License will not have their licenses terminated so long as such parties remain in full compliance.

9. You are not required to accept this License, since you have not signed it. However, nothing else grants you permission to modify or distribute the Library or its derivative works. These actions are prohibited by law if you do not accept this License. Therefore, by modifying or distributing the Library (or any work based on the Library), you indicate your acceptance of this License to do so, and all its terms and conditions for copying, distributing or modifying the Library or works based on it.

10. Each time you redistribute the Library (or any work based on the Library), the recipient automatically receives a license from the original licensor to copy, distribute, link with or modify the Library subject to these terms and conditions. You may not impose any further restrictions on the recipients' exercise of the rights granted herein. You are not responsible for enforcing compliance by third parties with this License.

11. If, as a consequence of a court judgment or allegation of patent infringement or for any other reason (not limited to patent issues), conditions are imposed on you (whether by court order, agreement or otherwise) that contradict the conditions of this License, they do not excuse you from the conditions of this License. If you cannot distribute so as to satisfy simultaneously your obligations under this License and any other pertinent obligations, then as a consequence you may not distribute the Library at all. For example, if a patent license would not permit royalty-free redistribution of the Library by all those who receive copies directly or indirectly through you, then the only way you could satisfy both it and this License would be to refrain entirely from distribution of the Library.

If any portion of this section is held invalid or unenforceable under any particular circumstance, the balance of the section is intended to apply, and the section as a whole is intended to apply in other circumstances.

It is not the purpose of this section to induce you to infringe any patents or other property right claims or to contest validity of any such claims; this section has the sole purpose of protecting the integrity of the free software distribution system which is implemented by public license practices. Many people have made generous contributions to the wide range of software distributed through that system in reliance on consistent application of that system; it is up to the author/donor to decide if he or she is willing to distribute software through any other system and a licensee cannot impose that choice.

This section is intended to make thoroughly clear what is believed to be a consequence of the rest of this License.

12. If the distribution and/or use of the Library is restricted in certain countries either by patents or by copyrighted interfaces, the original copyright holder who places the Library under this License may add an explicit geographical distribution limitation excluding those countries, so that distribution is permitted only in or among countries not thus excluded. In such case, this License incorporates the limitation as if written in the body of this License.

13. The Free Software Foundation may publish revised and/or new versions of the Lesser General Public License from time to time. Such new versions will be similar in spirit to the present version, but may differ in detail to address new problems or concerns. Each version is given a distinguishing version number. If the Library specifies a version number of this License which applies to it and "any later version", you have the option of following the terms and conditions either of that version or of any later version published by the Free Software Foundation. If the Library does not specify a license version number, you may choose any version ever published by the Free Software Foundation.

14. If you wish to incorporate parts of the Library into other free programs whose distribution conditions are incompatible with these, write to the author to ask for permission. For software which is copyrighted by the Free Software Foundation, write to the Free Software Foundation; we sometimes make exceptions for this. Our decision will be guided by the two goals of preserving the free status of all derivatives of our free software and of promoting the sharing and reuse of software generally.

NO WARRANTY

15. BECAUSE THE LIBRARY IS LICENSED FREE OF CHARGE, THERE IS NO WARRANTY FOR THE LIBRARY, TO THE EXTENT PERMITTED BY APPLICABLE LAW. EXCEPT WHEN OTHERWISE STATED IN WRITING THE COPYRIGHT HOLDERS AND/OR OTHER PARTIES PROVIDE THE LIBRARY "AS IS" WITHOUT WARRANTY OF ANY KIND, EITHER EXPRESSED OR IMPLIED, INCLUDING, BUT NOT LIMITED TO, THE IMPLIED WARRANTIES OF MERCHANTABILITY AND FITNESS FOR A PARTICULAR PURPOSE. THE ENTIRE RISK AS TO THE QUALITY AND PERFORMANCE OF THE LIBRARY IS WITH YOU. SHOULD THE LIBRARY PROVE DEFECTIVE, YOU ASSUME THE COST OF ALL NECESSARY SERVICING, REPAIR OR CORRECTION.

16. IN NO EVENT UNLESS REQUIRED BY APPLICABLE LAW OR AGREED TO IN WRITING WILL ANY COPYRIGHT HOLDER, OR ANY OTHER PARTY WHO MAY MODIFY AND/OR REDISTRIBUTE THE LIBRARY AS PERMITTED ABOVE, BE LIABLE TO YOU FOR DAMAGES, INCLUDING ANY GENERAL, SPECIAL, INCIDENTAL OR CONSEQUENTIAL DAMAGES ARISING OUT OF THE USE OR INABILITY TO USE THE LIBRARY (INCLUDING BUT NOT LIMITED TO LOSS OF DATA OR DATA BEING RENDERED INACCURATE OR LOSSES SUSTAINED BY YOU OR THIRD PARTIES OR A FAILURE OF THE LIBRARY TO OPERATE WITH ANY OTHER SOFTWARE), EVEN IF SUCH HOLDER OR OTHER PARTY HAS BEEN ADVISED OF THE POSSIBILITY OF SUCH DAMAGES.

END OF TERMS AND CONDITIONS

How to Apply These Terms to Your New Libraries

If you develop a new library, and you want it to be of the greatest possible use to the public, we recommend making it free software that everyone can redistribute and change. You can do so by permitting redistribution under these terms (or, alternatively, under the terms of the ordinary General Public License).

To apply these terms, attach the following notices to the library. It is safest to attach them to the start of each source file to most effectively convey the exclusion of warranty; and each file should have at least the "copyright" line and a pointer to where the full notice is found.

1 April 1990

Lexmark International, Inc.

That's all there is to it!